

R1-C2, R3-C3 TILPASSER HØRNE
FOR JUSTERING AV AVSPILLINGS-
KURVEN VED HENDLOSVAI 1 1/2
OG 3 3/4 PR. SEK

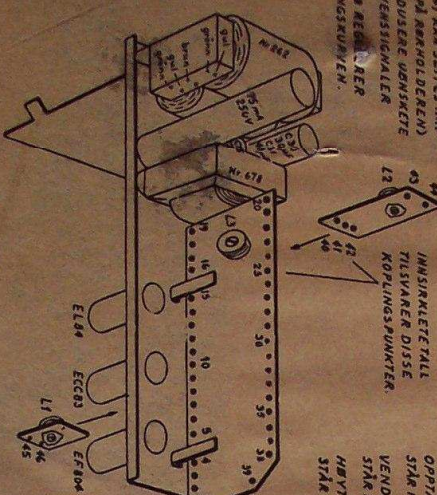

1) R20 TILPASSER HØRNE FOR
JUSTERING AV INNSPILLINGS-
STRØMMEN VED FULL SAMMEN-
KLAPPING AV TROLLØYET.

2) TEMPERATURSIKKRING, ROSES METALL.

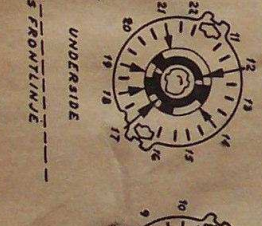
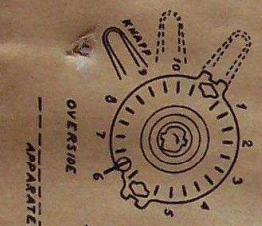
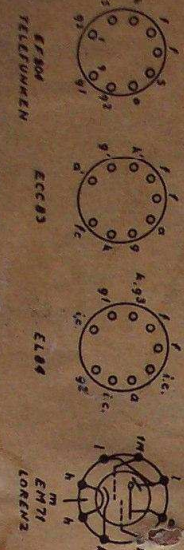

TEGN NR. 1628 C 1.A.

TANDBERG BÄNDOPPTAKER
TYPE 2



R1-C2, R5-C3 TILPASSES NODENE
FOR JUSTERING AV AVSPILLINGS-
KURVEN VED HENHOLDSVIS $1\frac{1}{8}$ "
OG $3\frac{3}{4}$ " PR. SEK

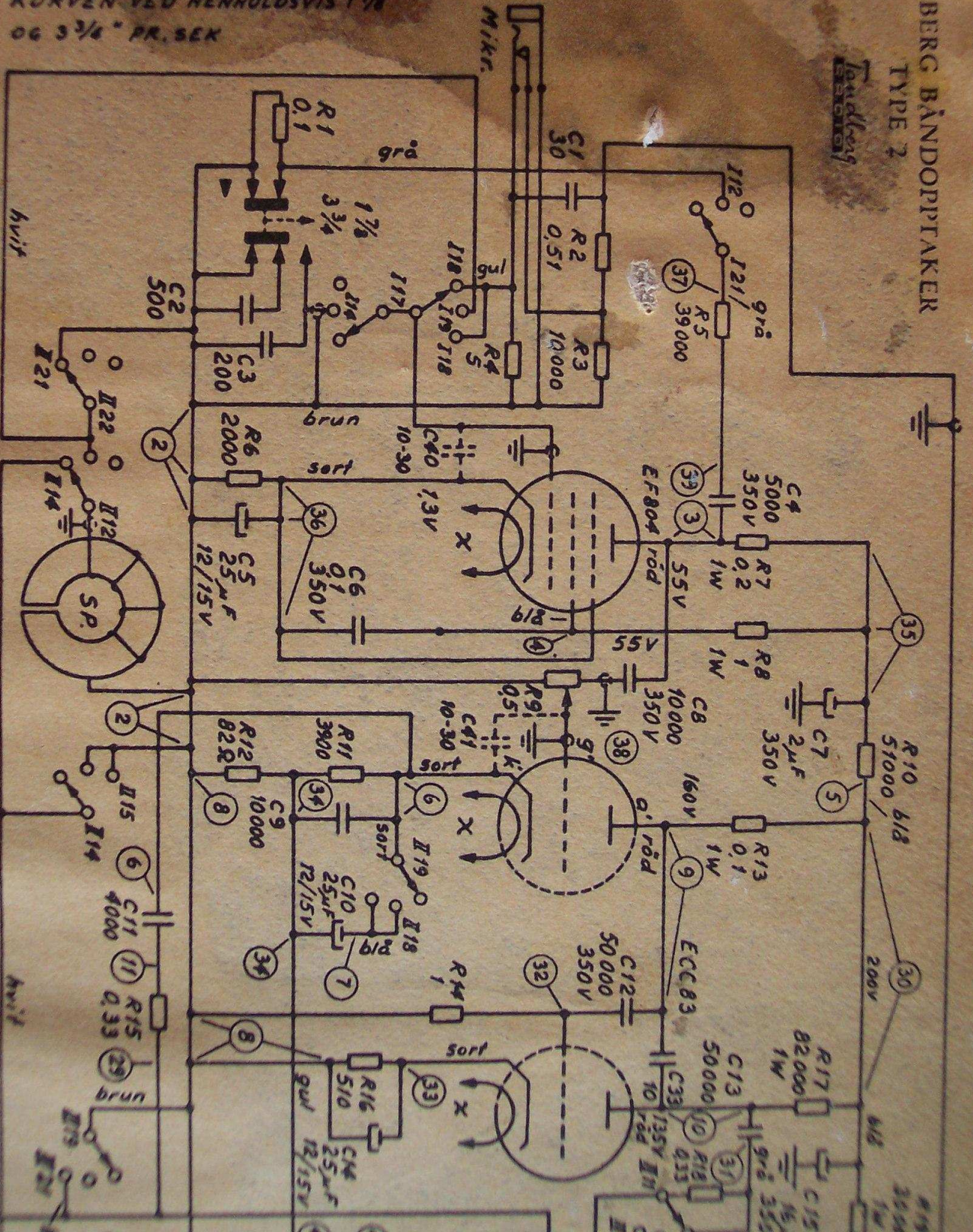

C40 OG C41 KAN SETTES INN
(DIRIKTE PÅ RØRHOLDEREN)
FOR Å REDUSERE UØNSKETE
HØREREVERBERASJONER



INNSIKRLETTETALL
TILSVARER DISSE

OPPTAKVENDER DERRE 2. GANG
SPÅR I STILLING: INN.

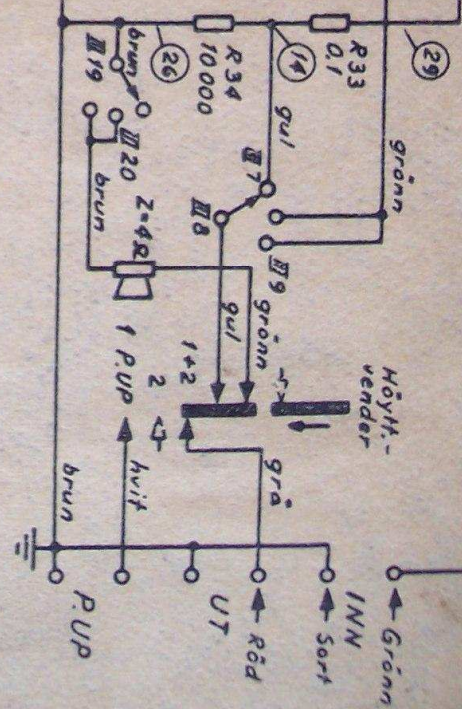
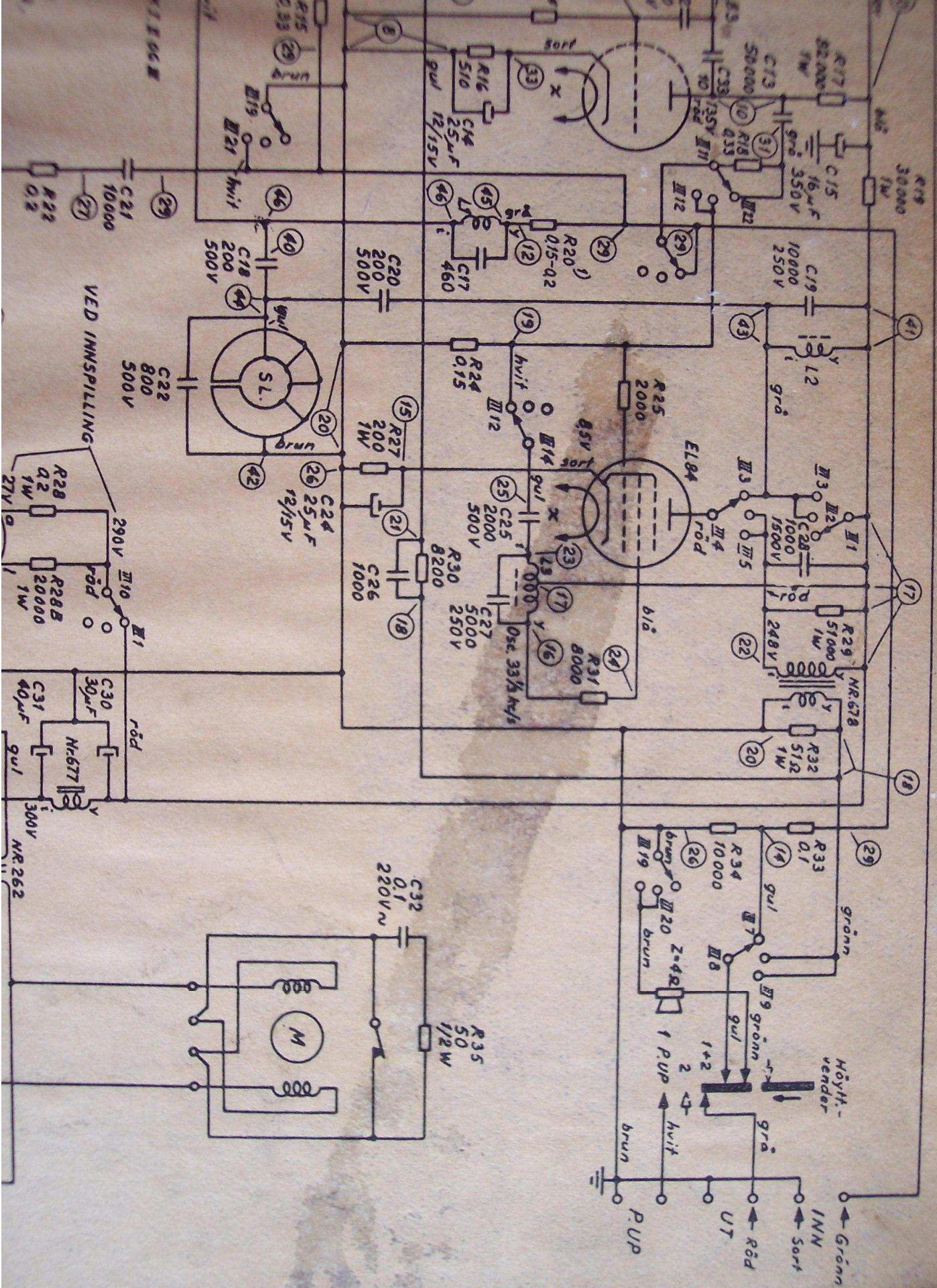

VED INNSPILLING

Höyft-vender
 Grön
 Röd
 UT
 PUP

R1-C2, R3-C3
FOR JUSTERING
KURVEN VED R
OG 3 3/4" PR. 50

C20 OG C21 KAN SETTES INN
(DIREKTE PÅ RØRHOLDEREN)
FOR Å REDUSERE UØNSKETE
HØYFREKVENSSIGNALER
C9 C11 C18 REGULERER
INNSPILINGSKURVEN.

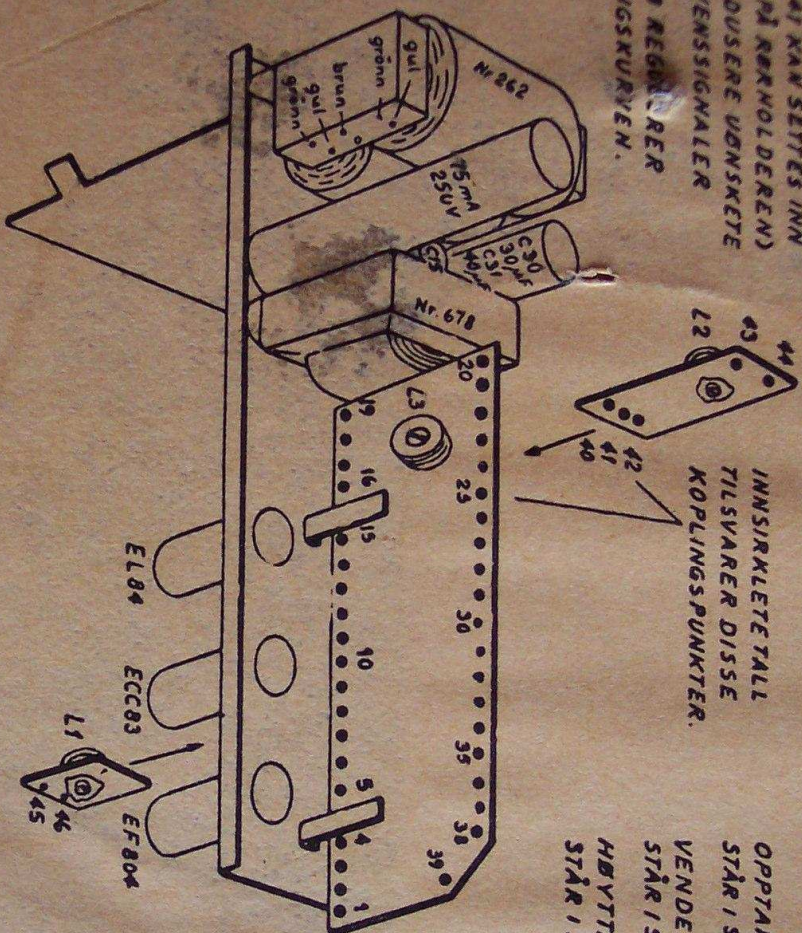
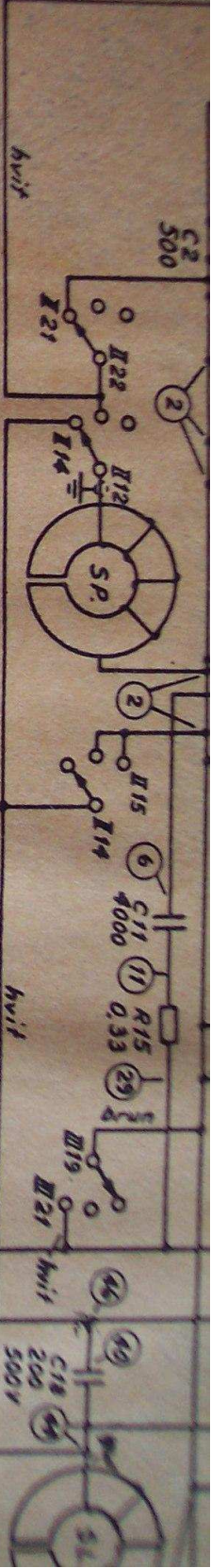

INNSIRKLETTALL
TILSVARER DISSE
KOPPLINGS-PUNKTER.

OPPTAKVENDER DEKK I, II OG III
STÅR I STILLING: INN.
VENDER 3 3/4 - 1 7/8
STÅR I STILLING: 3 3/4.
HØYTTALERVENDER
STÅR I STILLING: 1 + 2.

1) R20 TILPASSES HODENE FOR
JUSTERING AV INNSPILINGS-
STRØMMEN VED FULL SAMMEN-
KLAPPING AV TROLLØYET.
LIKESPENNINGER ER MÅLT
VED AVSPILNING UNDATT
FOR EM 71.

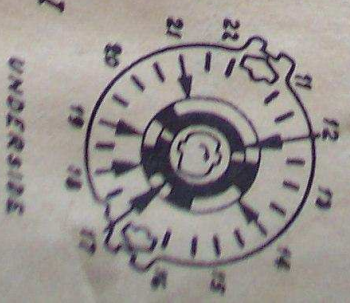
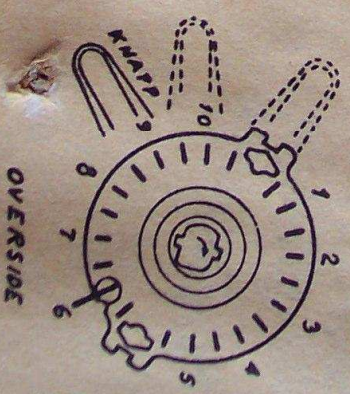
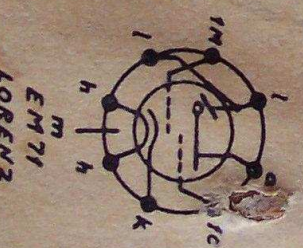
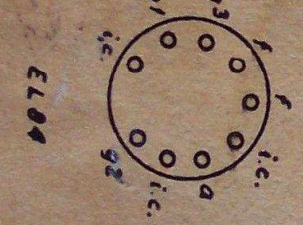
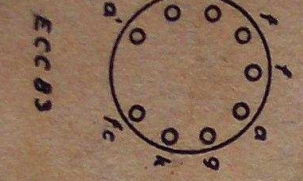
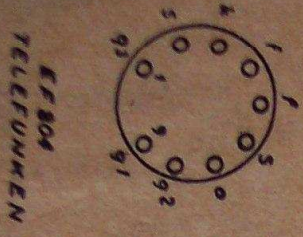

APPARATETS FRONTSIDE

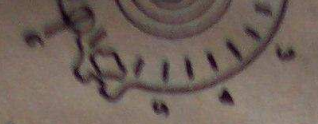
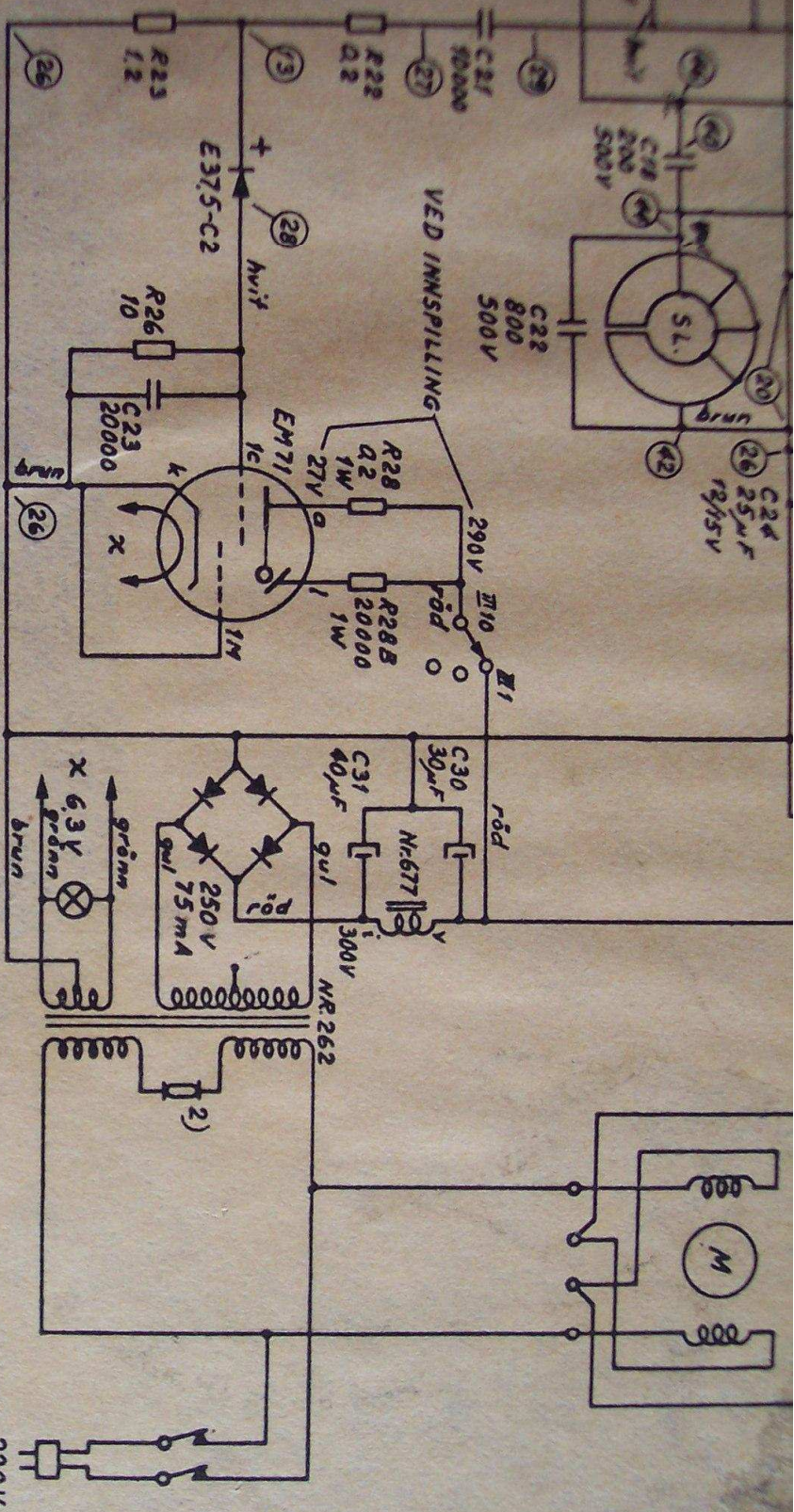

UNDERSIDE



UNDERSIDE

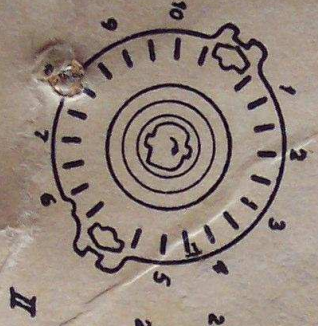

UNDERSIDE

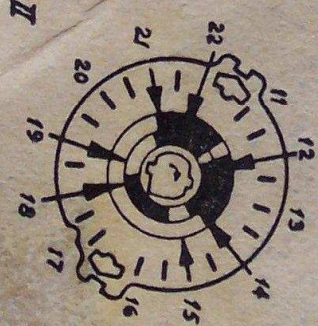

UNDERSIDE

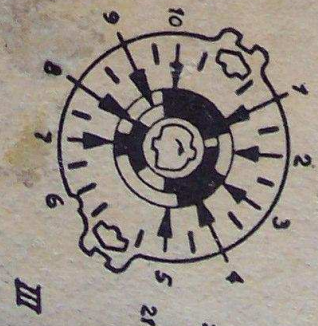

UNDERSIDE



FRONTLINJE

VENDER NR. 1756
SETT FRA KNAPPESIDEN.

TEGN. NR. 1628 C
E.A.