

# Alignment Instruction

## TR-1040P

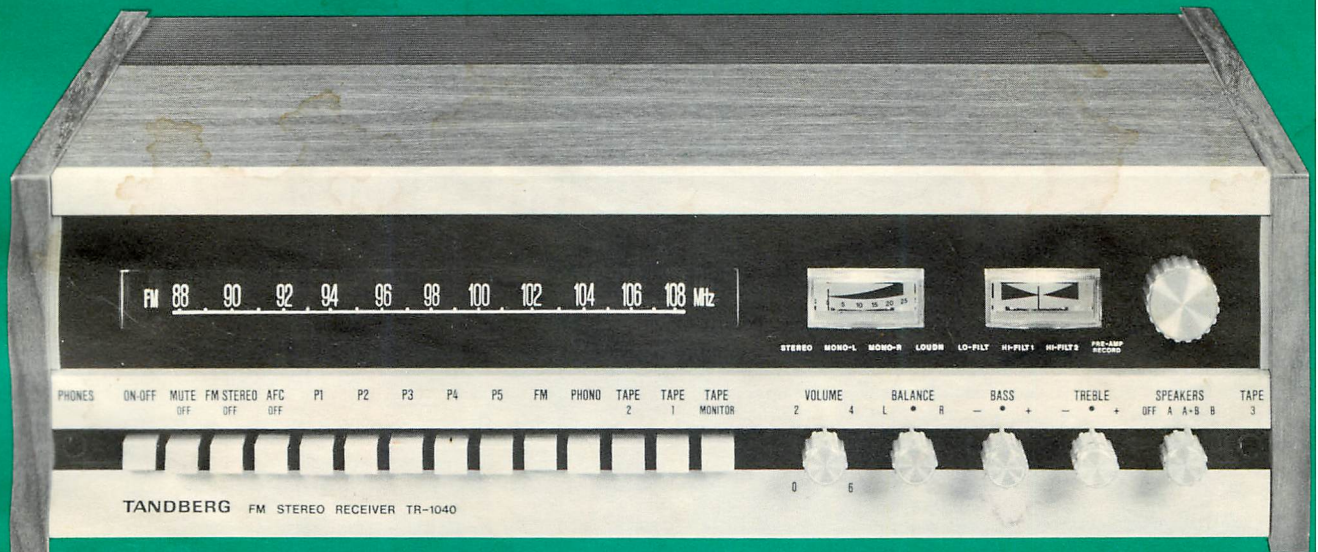

# TANDBERG



## 1.0 ALIGNMENT OF STEREO-DECODER

### 1.1 Complete alignment.

A complete alignment involves adjustment of

- The decoder oscillator; 19 kHz (paragraph 1.2)
- Channel separation (paragraph 1.2.1).
- 19 kHz filter (paragraph 1.2.2)
- Stereo/mono switching threshold (paragraph 1.2.3)
- **Definition:** Pilotsignal 19 kHz ( $\pm 2$  Hz).

The following equipment is needed for a complete adjustment:

- FM stereo generator
- Oscilloscope with sensitivity 5 mV/cm
- Frequency counter
- Selective voltmeter or a.c. voltmeter and 20 kHz low pass filter

### 1.2 The decoder oscillator: 19 kHz.

Apply a 1 mV signal from the FM stereo generator, unmodulated.

Adjust R808 so that the frequency counter connected to M801 indicates 19 kHz.

**Alternative method:** This adjustment can be carried out without a frequency counter as follows: Apply a 1 mV signal from the FM stereo generator, modulated with 10% pilotsignal.

Turn R808 slowly from one extreme to the point where the stereo indicator lights up. Turn further in the same direction until the light goes out. Then turn in the opposite direction to set R808 in the middle of the range where the indicator lights.

#### 1.2.1 Channel separation:

Apply a 1 mV signal to the antenna input from the FM stereo generator and set the generator for 10% pilotsignal. Modulate the right channel with 1 kHz at 30% deviation. Connect the oscilloscope to the TAPE OUT socket, of the left channel and adjust R840 to minimum deflection.

Check this adjustment with the 1 kHz signal in the left channel and measure the output of the right channel.

**Alternative method:** Adjust R840 for minimum signal in the left (right) speaker when receiving a test FM stereo transmission with signal in the right (left) channel only.

#### 1.2.2 19 kHz filter.

Apply a 1 mV signal from the FM stereo generator to the antenna input and set the generator for 10% pilotsignal.

Adjust R833 and R835 (R834 and R836) alternatively for minimum signal at the left (right) TAPE OUT. Use a selective voltmeter or an a.c. voltmeter with a low pass filter at 20 kHz to avoid signal components at 38 kHz causing a false indication.

#### 1.2.3 Stereo/mono switching threshold.

Apply a 10  $\mu$ V signal from the FM stereo generator to the 75 ohm antenna input and adjust the generator for 10% pilotsignal. Set R221 fully counterclockwise (seen from the component side) and then turn R221 slowly clockwise until the stereo indicator lights up.

**Note!** If a FM stereo generator is not available an ordinary FM generator can be used for this adjustment. In this case it may be necessary to check the modulation frequency (19 kHz) with the frequency counter.

#### Alignment of FM-section

See the FM-alignment procedure in table and the oscillograms.

Table, FM-alignment.

Step	Alignment procedure	Receiver	
		Frequency	Frequency
1	FM-oscillator		
1A	25V for varicap		
1B	FM-osc. (FM)	90 MHz 105 MHz	90 MHz 105 MHz
1C	FM-preset (P1)	87.5 MHz 105 MHz	87.5 MHz 105 MHz
2	Aerial circuit	90 MHz 105 MHz	90 MHz 105 MHz
3	FM-IF	90 MHz	90 MHz
4	Discriminator	90 MHz	90 MHz
5	Center tuning meter	90 MHz	90 MHz
6	Field strength indicator	90 MHz	90 MHz
7		90 MHz	90 MHz



Fig. 3 Selectivity FM

SIGNAL:  $U_{in} = 150 \mu V / 75 \text{ ohms}$ ,  $f = 90 \text{ MHz}$ , dev. =  $\pm 200 \text{ kHz}$  applied M1 via ant. plug.

OSCILLOSCOPE: Vert.:  $5 \text{ mV/dev.}$ , Hor.:  $50 \text{ kHz/dev.}$  connected to M4 via diodeprobe (Fig. 5).

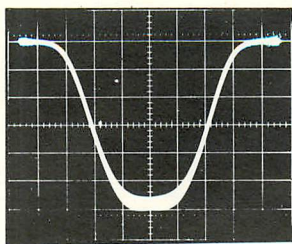

Fig. 4 Discriminator

SIGNAL:  $U_{in} = 2 \mu V / 75 \text{ ohms}$ ,  $f = 90 \text{ MHz}$ , dev. =  $\pm 200 \text{ kHz}$  applied M1 via ant. plug.

OSCILLOSCOPE: Vert.:  $0.2 \text{ v/dev.}$  Hor.:  $50 \text{ kHz/dev.}$  connected to TAPE OUT (M6).

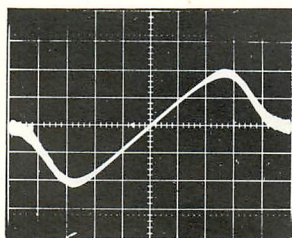
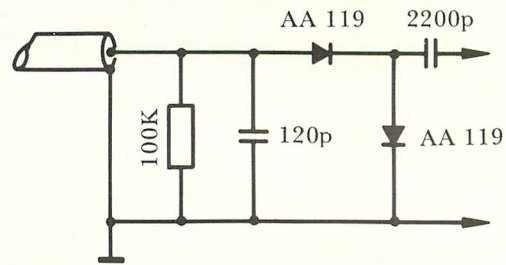

Fig.5 Diodeprobe.



Generator		Oscilloscope	Circuits	Notes
Deviation	Applied to	Connected to	Adjust	
				AFC-button depressed
			R 438	Meter connected to M13 Adjust to 25 V DC reading
$\pm 22.5 \text{ kHz}$	M 1	M 4 via diodeprobe ( fig. 5 )	R 409 C 118	Check 95 and 100 MHz
$\pm 22.5 \text{ kHz}$	M 1	M 4 via diodeprobe ( fig. 5 )	R 402	Check P2 - P3 - P4 - P5
$\pm 200 \text{ kHz}$	M 1	M 4 via diodeprobe ( fig. 5 )	L101, L102, L103 C103 C107, C110	Adjust for max. curve height (see Fig. 3).
$\pm 200 \text{ kHz}$	M 1	M 4 via diodeprobe ( fig. 5 )	L106, L107	Adjust for max. curve height and symmetry (see Fig. 3) FM-IF 10.6 – 10.8 MHz.
$\pm 75 \text{ kHz}$	M 1 1 mV/75 ohm		L 202, L 203	Voltmeter connected to M6: L203 adjust for max. output voltage. Dist./voltm. connected to M6: L202 adjust for min. output voltage and min. distortion (see Fig. 4).
$\pm 75 \text{ kHz}$	M 1 1 mV/ 75 ohm		R 234	Adjust for center position of the pointer
	M 1 50 mV/75 ohm		R 224	Adjust R224 for 80-90% max. meter reading at a signal voltage of about 50 mV.
$\pm 75 \text{ kHz}$	M 1	M 4 via diodeprobe ( fig. 5 )	R 240	The curve should remain stationary when the AFC-button is released.







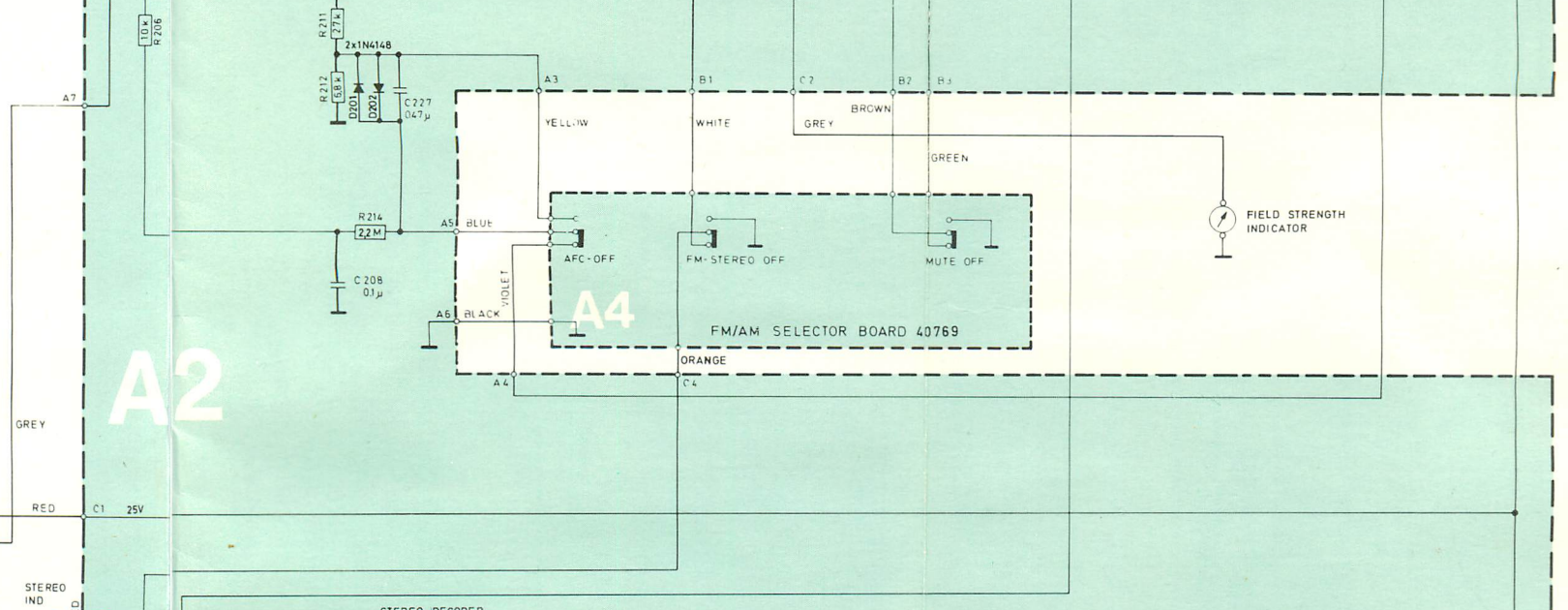
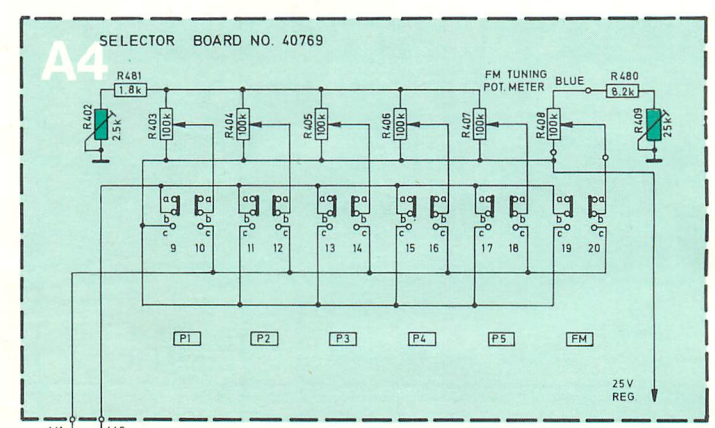
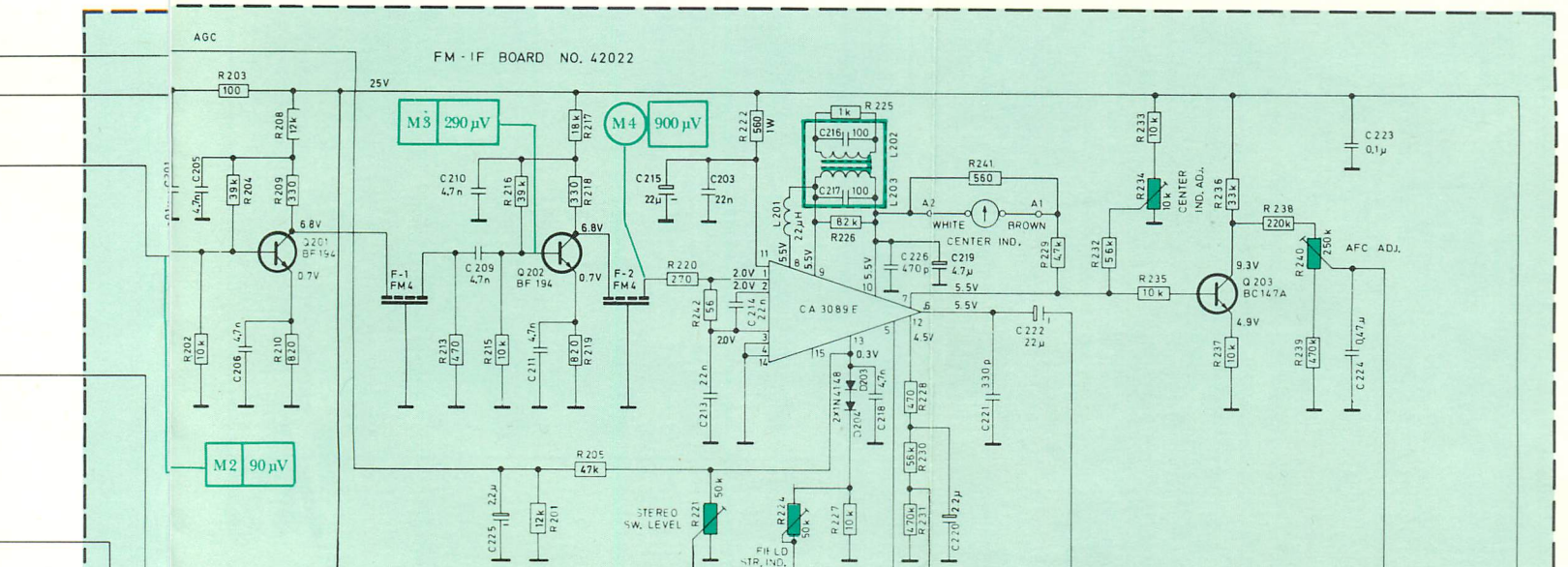
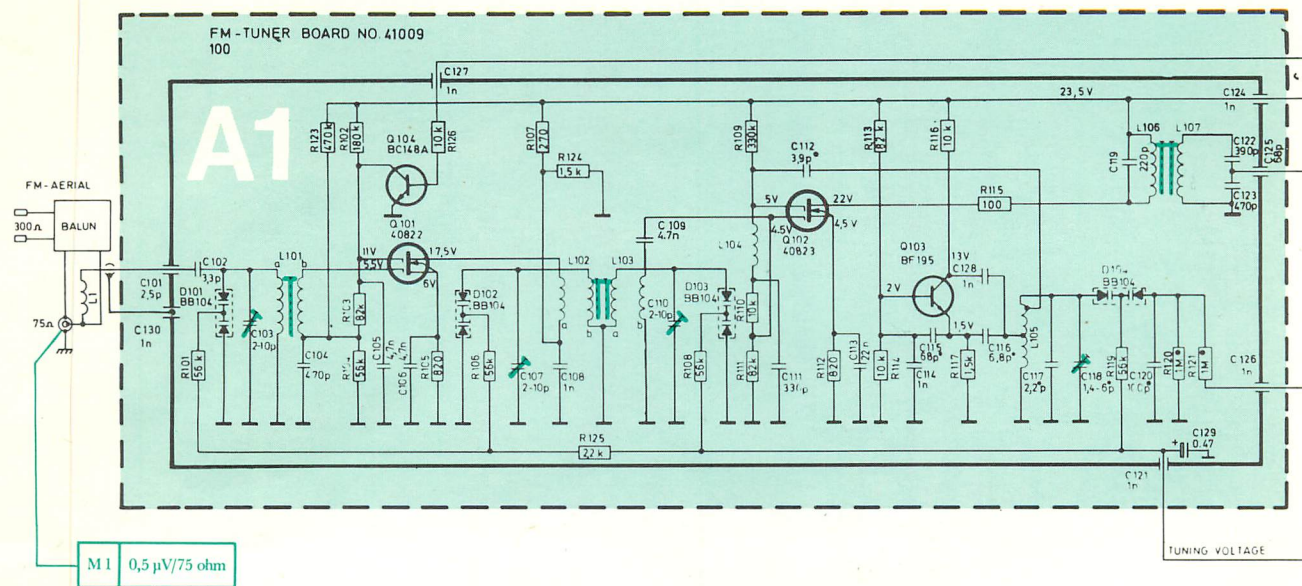

RESISTANCE VALUES ARE OHMS k=1000, M=1000000. RESISTORS ARE 0.5WATT OR LESS UNLESS OTHERWISE SPECIFIED. ALL SWITCHES ARE DRAWN IN UNOPERATED POSITION. ALL RESISTORS ARE DRAWN IN UNOPERATED POSITION. CAPACITORS MARKED WITH A DOT ARE LOW NOISE TYPES. CAPACITORS MARKED WITH A DOT HAVE A SPECIFIED TEMPERATURE COEFFICIENT.

C 112 33pF N 33  
 C 115 0.01uF N 750  
 C 116 0.01uF N 750  
 C 117 2.2pF N 100  
 C 118 1.4-6pF N 100  
 C 120 100pF N 750 (N1500 USED IN SOME CASES)

SUBJECT TO CHANGES WITHOUT FURTHER NOTICE

All selectors are shown in unoperated position.

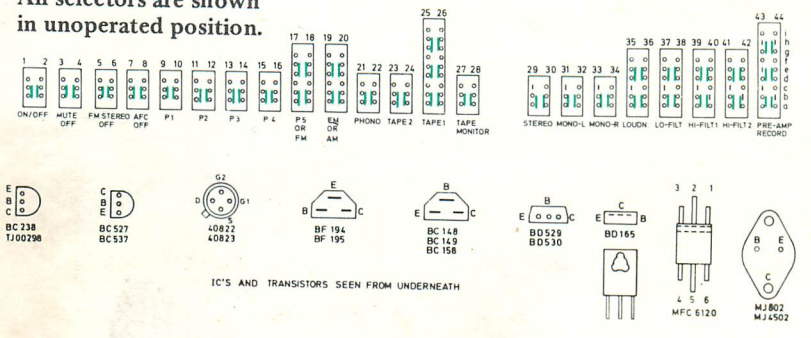

Tuner section. 40859

1/ C809 and C810 are 15n in US models.



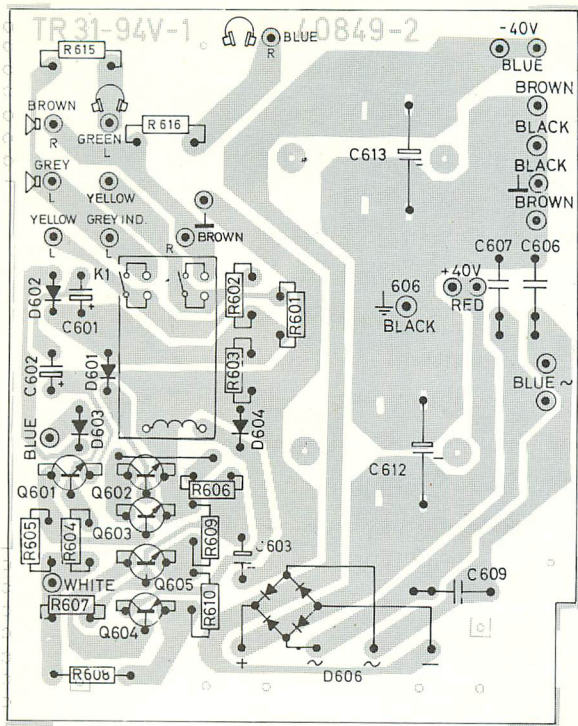

**A6**

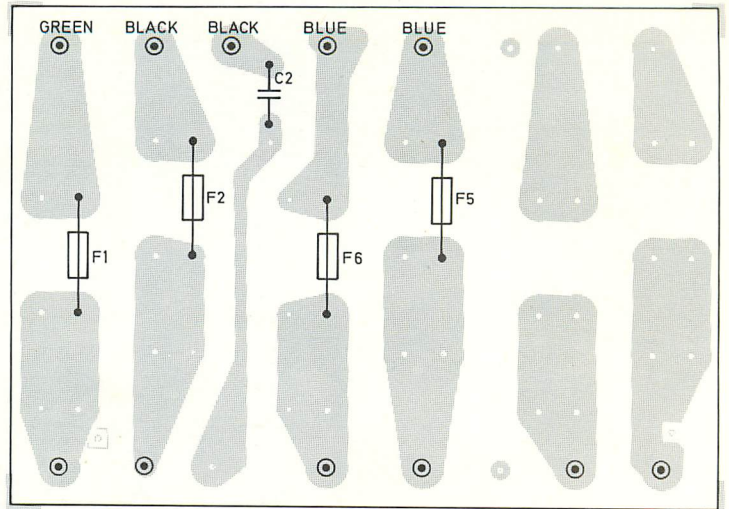

**A9**

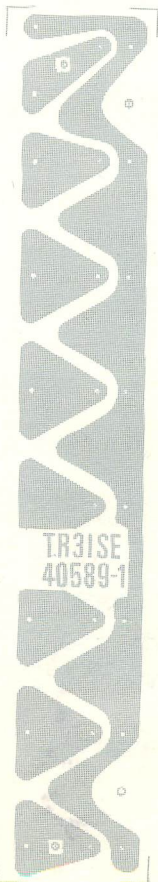

**A10**

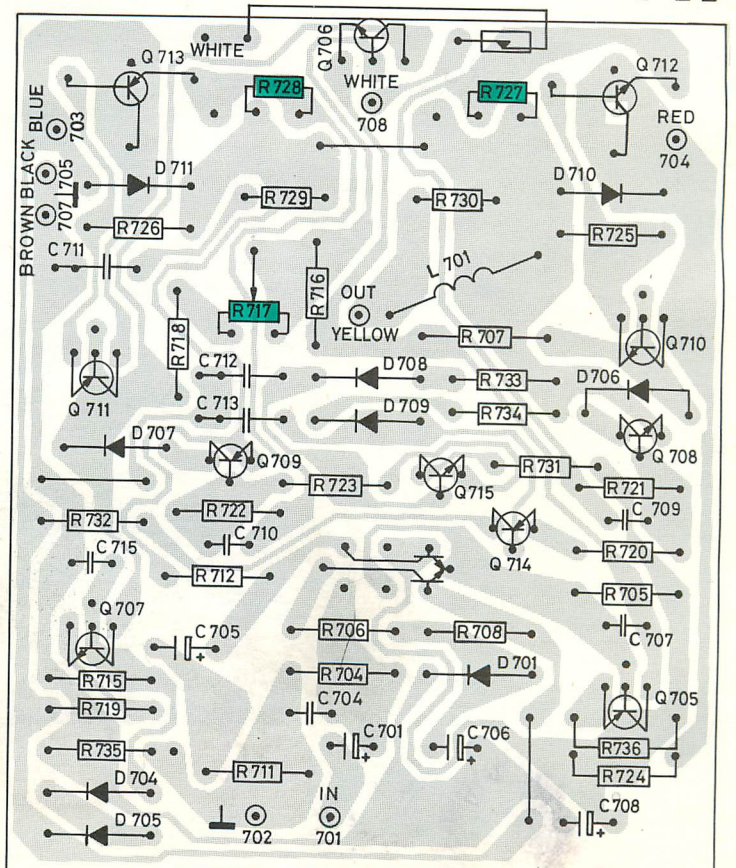

**A7**







RESISTANCE VALUES ARE OHMS  $\times 1000$ , M=1000000. RESISTORS ARE 0.5WATT OR LESS UNLESS OTHERWISE SPECIFIED. ALL SWITCHES ARE DRAWN IN UNOPERATED POSITION. ALL RESISTORS MARKED WITH A DOT ARE LOW NOISE TYPES. 1) SWITCH-NOISE SUPPRESSOR.

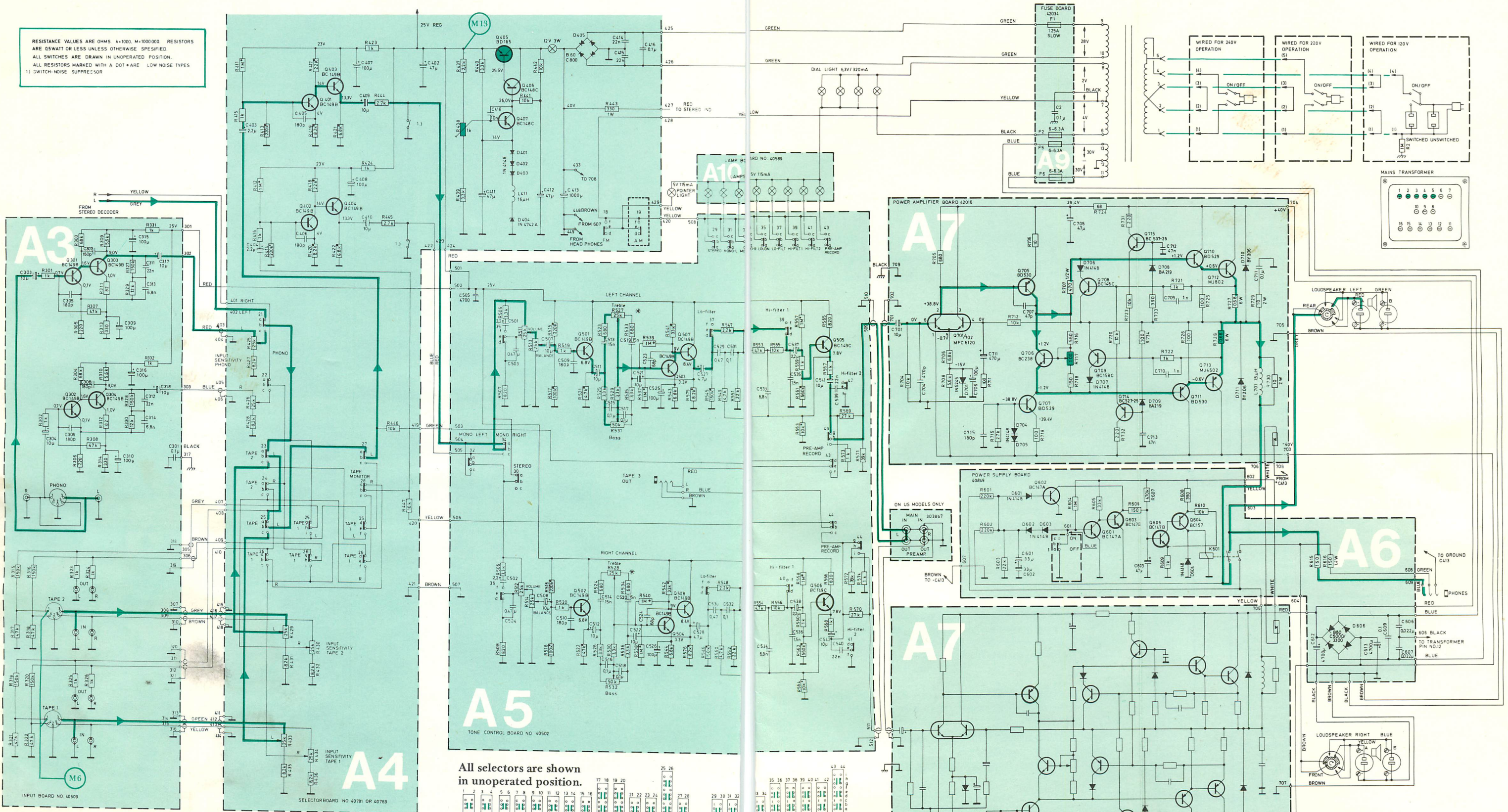

**Quiescent current.**

The quiescent current in both channels can be checked by measuring the voltage across R728. Immediately after power has been switched on and with the volume at minimum the voltage should be 25 mV. If necessary, adjust with R717. After 10 minutes warm-up the voltage will normally be 40 mV.

The most convenient place to connect the voltmeter is between the top of R727 and the top of R728 (on the component side of the board).

All selectors are shown in unoperated position.

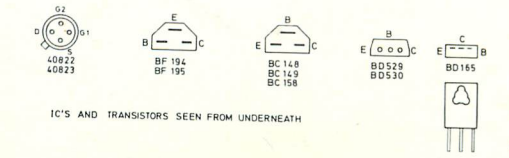
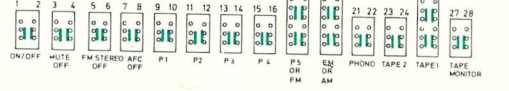



# FM SECTION

<b>Tuning range:</b>	87.5-108 MHz
<b>Sensitivity IHF:</b> (signal/noise + distortion)	2.0 $\mu$ V /300 ohms (11.2 dBf)
<b>Sensitivity DIN 45301:</b> at 26 dB signal/noise	1.6 $\mu$ V /300 ohms (9.3 dBf)
<b>50 dB quieting:</b>	3.5 $\mu$ V /300 ohms (16.2 dBf)
<b>Signal/noise, IHF:</b> at 1 mV antenna voltage (65 dBf), unweighted	MONO : 68 dB STEREO : 66 dB
<b>Selectivity:</b> Carrier down (alternate channel) IHF Dynamic (alternate channel) Carrier down (adjacent channel) IHF Dynamic (adjacent channel)	100 dB at $\pm$ 400 kHz 80 dB at $\pm$ 400 kHz 40 dB at $\pm$ 200 kHz 10 dB at $\pm$ 200 kHz
<b>Image frequency rejection:</b>	Greater than 70 dB
<b>IF rejection:</b>	Greater than 95 dB
<b>Spurious response:</b>	Greater than 95 dB
<b>AM suppression:</b>	Greater than 50 dB
<b>Capture ratio:</b> at 1 mV antenna voltage (65 dBf) (selectively measured).	0.9 dB
<b>Limiting (-3 dB):</b>	1.4 $\mu$ V /300 ohms (7.8 dBf)
<b>Muting threshold:</b>	3 $\mu$ V /300 ohms (14.8 dBf)
<b>Audio frequency response:</b> at $\pm$ 2 dB	20-15,000 Hz
<b>Total harmonic distortion:</b> 100% modulation	MONO : 0.2% STEREO : 0.3%
<b>Channel separation:</b> at 100 Hz to 10,000 Hz (selectively measured).	Greater than 40 dB
<b>Pilot tone suppression:</b>	Greater than 68 dB
<b>38 kHz suppression:</b>	Greater than 60 dB
<b>SCA suppression:</b>	Greater than 70 dB

# GENERAL

<b>AC power requirement:</b>	120-220-240 V, 50/60 Hz
<b>Dimensions:</b>	Width: 17 $\frac{3}{4}$ " (44 cm) Height: 5 $\frac{3}{16}$ " (13.2 cm) Depth: 12 $\frac{1}{4}$ " + knobs $\frac{3}{4}$ " (31 + 2 cm)
<b>Weight:</b>	20 lbs (9 kg)

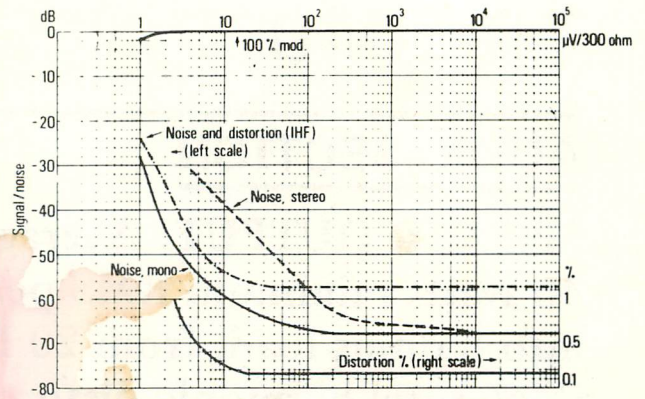

**FM SENSITIVITY AND DISTORTION**

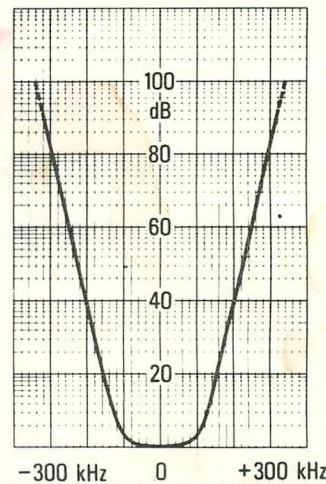

**FM SELECTIVITY**



# TECHNICAL DATA

## TR-1040

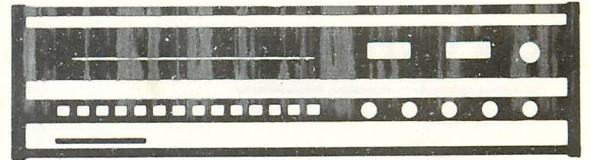

### AUDIO SECTION

**\*POWER OUTPUT:** Average continuous sinewave power is 40 watts minimum RMS per channel, both channels driven into 8 ohms load, from 20 Hz to 20 kHz with no more than 0.2% total harmonic distortion from 1/4 watt to 40 watts as specified herein.

Power output:  
 continuous, both channels driven into 4 ohms load at 1 kHz, 0.2% distortion. 2 x 60 watts

**\* TOTAL HARMONIC DISTORTION:** Maximum 0.2% at any power from 1/4 watt up to rated power.

Intermodulation: (IHF)	Less than 0.2%
Damping factor: at 20-20,000 Hz	25 at 4 ohms 50 at 8 ohms
Frequency range: linear inputs at -1.5 dB	7-70,000 Hz
Treble control range:	± 15 dB at 10,000 Hz
Treble loudness:	+ 7 dB at 10,000 Hz
Bass control range:	± 16 dB at 50 Hz
Bass loudness:	+ 12 dB at 50 Hz
LOW-filter:	- 3 dB at 70 Hz (-12 dB/octave)
HIGH-filter 1:	- 3 dB at 8,000 Hz (-12 dB/octave)
HIGH-filter 2:	- 3 dB at 8,000 Hz (-6 dB/octave)
Channel separation: at 1 kHz	TAPE: 55 dB PHONO: 52 dB
Signal/hum and noise ratio, IHF: reference max. output into 8 ohms load, shorted input, no filter network used. Preset level controls - 6 dB	TAPE 1 : 82 dB TAPE 2 : 82 dB PHONO : 68 dB Power amplifier only: 90 dB
Sensitivity: at maximum power output in 8 ohms	TAPE 1 : adjustable 130 - 500 mV (Input imp.: 27 - 33 kohms) TAPE 2 : adjustable 130 - 500 mV (Input imp.: 27 - 33 kohms) PHONO: adjustable 1.8 - 6 mV (Input imp.: 47 kohms)
Maximum input signals: 0.2% distortion at 1 kHz, preset level controls at minimum.	TAPE 1 : 8 V TAPE 2 : 8 V PHONO : 100 mV
Output of TAPE sockets: (unloaded)	PHONO sockets: 1 V (Output imp.: 1 kohms) DIN sockets: 200 mV (Output imp.: 33 kohms)
Main amp sensitivity:	200 mV (Input imp.: 10 kohms)
Pre-amp output:	1 V (Output imp.: 1 kohm)

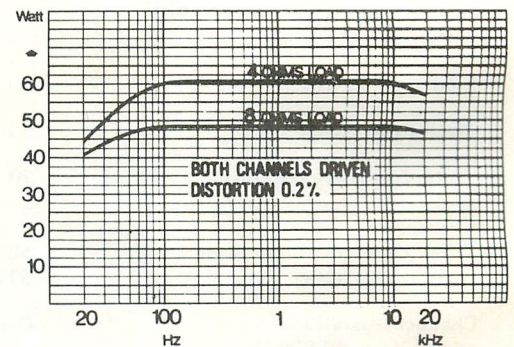

POWER OUTPUT

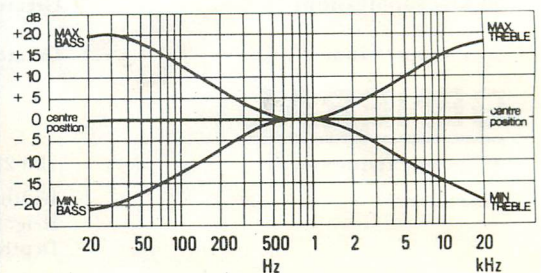

TONE CONTROLS

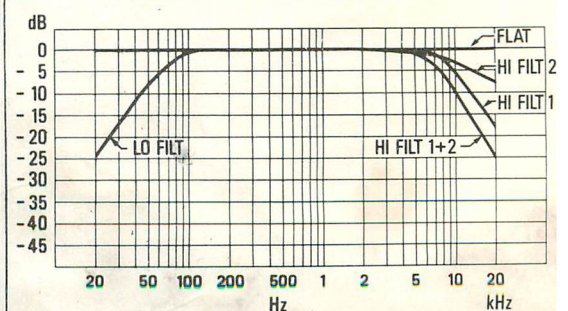

LOW AND HIGH FILTERS



# FM SECTION

<b>Tuning range:</b>	87.5-108 MHz
<b>Sensitivity IHF:</b> (signal/noise + distortion)	2.0 $\mu$ V /300 ohms (11.2 dBf)
<b>Sensitivity DIN 45301:</b> at 26 dB signal/noise	1.6 $\mu$ V /300 ohms (9.3 dBf)
<b>50 dB quieting:</b>	3.5 $\mu$ V /300 ohms (16.2 dBf)
<b>Signal/noise, IHF:</b> at 1 mV antenna voltage (65 dBf), unweighted	MONO : 68 dB STEREO : 66 dB
<b>Selectivity:</b> Carrier down (alternate channel) IHF Dynamic (alternate channel) Carrier down (adjacent channel) IHF Dynamic (adjacent channel)	100 dB at $\pm$ 400 kHz 80 dB at $\pm$ 400 kHz 40 dB at $\pm$ 200 kHz 10 dB at $\pm$ 200 kHz
<b>Image frequency rejection:</b>	Greater than 70 dB
<b>IF rejection:</b>	Greater than 95 dB
<b>Spurious response:</b>	Greater than 95 dB
<b>AM suppression:</b>	Greater than 50 dB
<b>Capture ratio:</b> at 1 mV antenna voltage (65 dBf) (selectively measured).	0.9 dB
<b>Limiting (-3 dB):</b>	1.4 $\mu$ V /300 ohms (7.8 dBf)
<b>Muting threshold:</b>	3 $\mu$ V /300 ohms (14.8 dBf)
<b>Audio frequency response:</b> at $\pm$ 2 dB	20-15,000 Hz
<b>Total harmonic distortion:</b> 100% modulation	MONO : 0.2% STEREO : 0.3%
<b>Channel separation:</b> at 100 Hz to 10,000 Hz (selectively measured).	Greater than 40 dB
<b>Pilot tone suppression:</b>	Greater than 68 dB
<b>38 kHz suppression:</b>	Greater than 60 dB
<b>SCA suppression:</b>	Greater than 70 dB

# GENERAL

<b>AC power requirement:</b>	120-220-240 V, 50/60 Hz
<b>Dimensions:</b>	Width: 17 $\frac{3}{4}$ " (44 cm) Height: 5 $\frac{3}{16}$ " (13.2 cm) Depth: 12 $\frac{1}{4}$ " + knobs $\frac{3}{4}$ " (31 + 2 cm)
<b>Weight:</b>	20 lbs (9 kg)

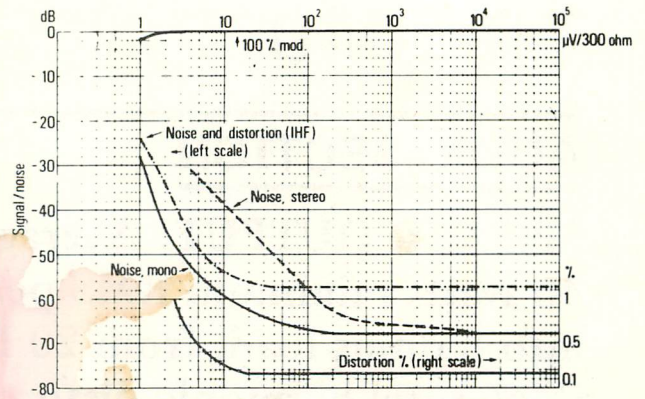

FM SENSITIVITY AND DISTORTION

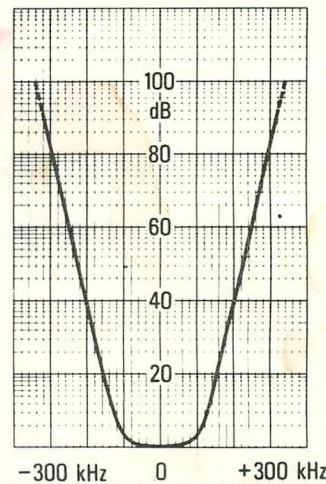

FM SELECTIVITY



# TECHNICAL DATA

## TR-1040

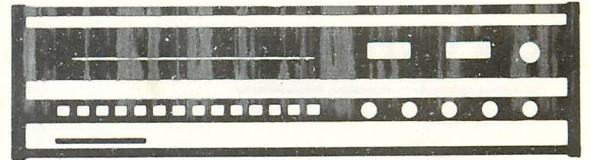

### AUDIO SECTION

**\*POWER OUTPUT:** Average continuous sinewave power is 40 watts minimum RMS per channel, both channels driven into 8 ohms load, from 20 Hz to 20 kHz with no more than 0.2% total harmonic distortion from 1/4 watt to 40 watts as specified herein.

Power output:  
 continuous, both channels driven into 4 ohms load at 1 kHz, 0.2% distortion. 2 x 60 watts

**\* TOTAL HARMONIC DISTORTION:** Maximum 0.2% at any power from 1/4 watt up to rated power.

Intermodulation: (IHF)	Less than 0.2%
Damping factor: at 20-20,000 Hz	25 at 4 ohms 50 at 8 ohms
Frequency range: linear inputs at -1.5 dB	7-70,000 Hz
Treble control range:	± 15 dB at 10,000 Hz
Treble loudness:	+ 7 dB at 10,000 Hz
Bass control range:	± 16 dB at 50 Hz
Bass loudness:	+ 12 dB at 50 Hz
LOW-filter:	- 3 dB at 70 Hz (-12 dB/octave)
HIGH-filter 1:	- 3 dB at 8,000 Hz (-12 dB/octave)
HIGH-filter 2:	- 3 dB at 8,000 Hz (-6 dB/octave)
Channel separation: at 1 kHz	TAPE: 55 dB PHONO: 52 dB
Signal/hum and noise ratio, IHF: reference max. output into 8 ohms load, shorted input, no filter network used. Preset level controls - 6 dB	TAPE 1 : 82 dB TAPE 2 : 82 dB PHONO : 68 dB Power amplifier only: 90 dB
Sensitivity: at maximum power output in 8 ohms	TAPE 1 : adjustable 130 - 500 mV (Input imp.: 27 - 33 kohms) TAPE 2 : adjustable 130 - 500 mV (Input imp.: 27 - 33 kohms) PHONO: adjustable 1.8 - 6 mV (Input imp.: 47 kohms)
Maximum input signals: 0.2% distortion at 1 kHz, preset level controls at minimum.	TAPE 1 : 8 V TAPE 2 : 8 V PHONO : 100 mV
Output of TAPE sockets: (unloaded)	PHONO sockets: 1 V (Output imp.: 1 kohms) DIN sockets: 200 mV (Output imp.: 33 kohms)
Main amp sensitivity:	200 mV (Input imp.: 10 kohms)
Pre-amp output:	1 V (Output imp.: 1 kohm)

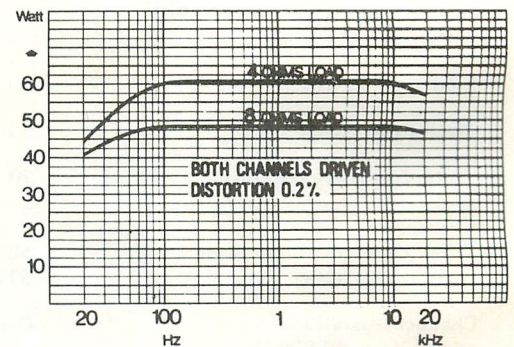

POWER OUTPUT

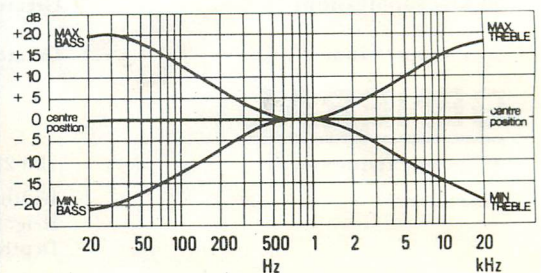

TONE CONTROLS

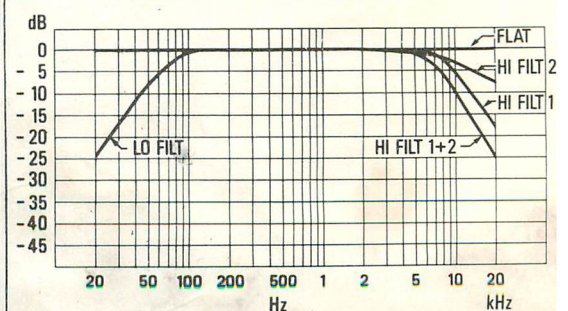

LOW AND HIGH FILTERS



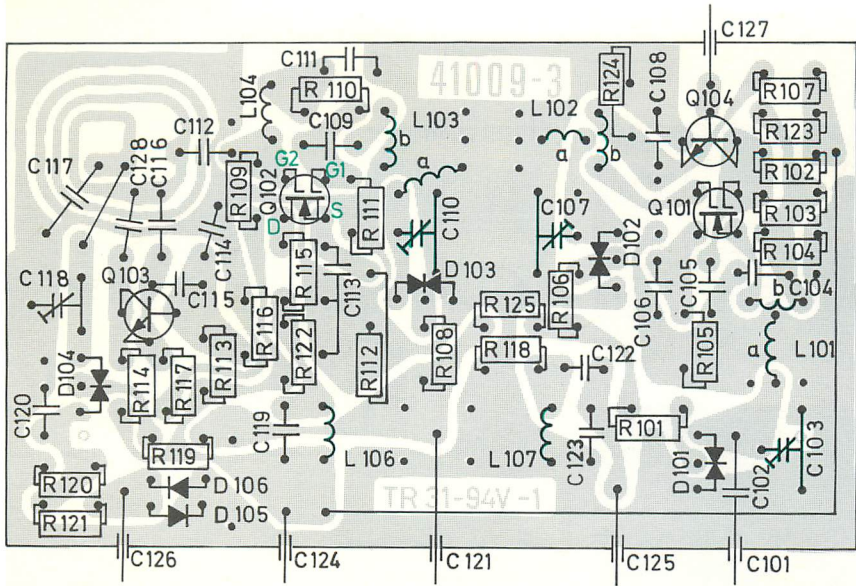

A1

A4

A2

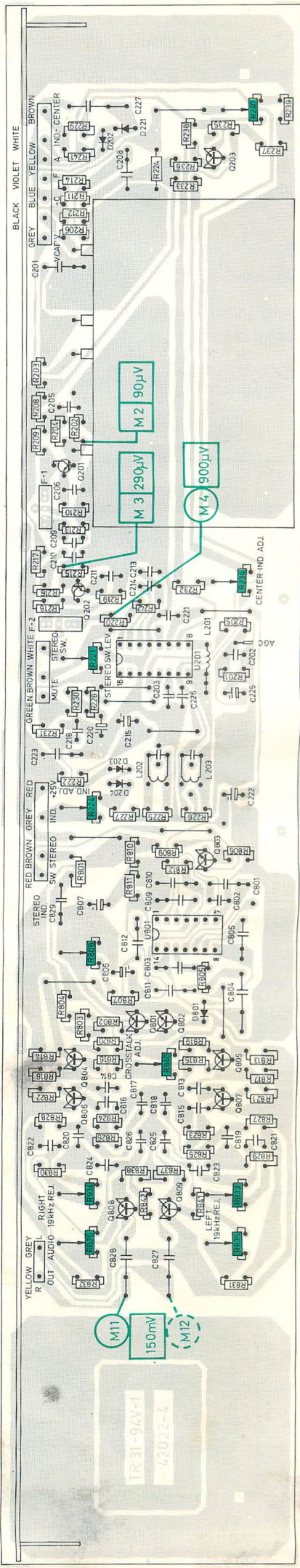
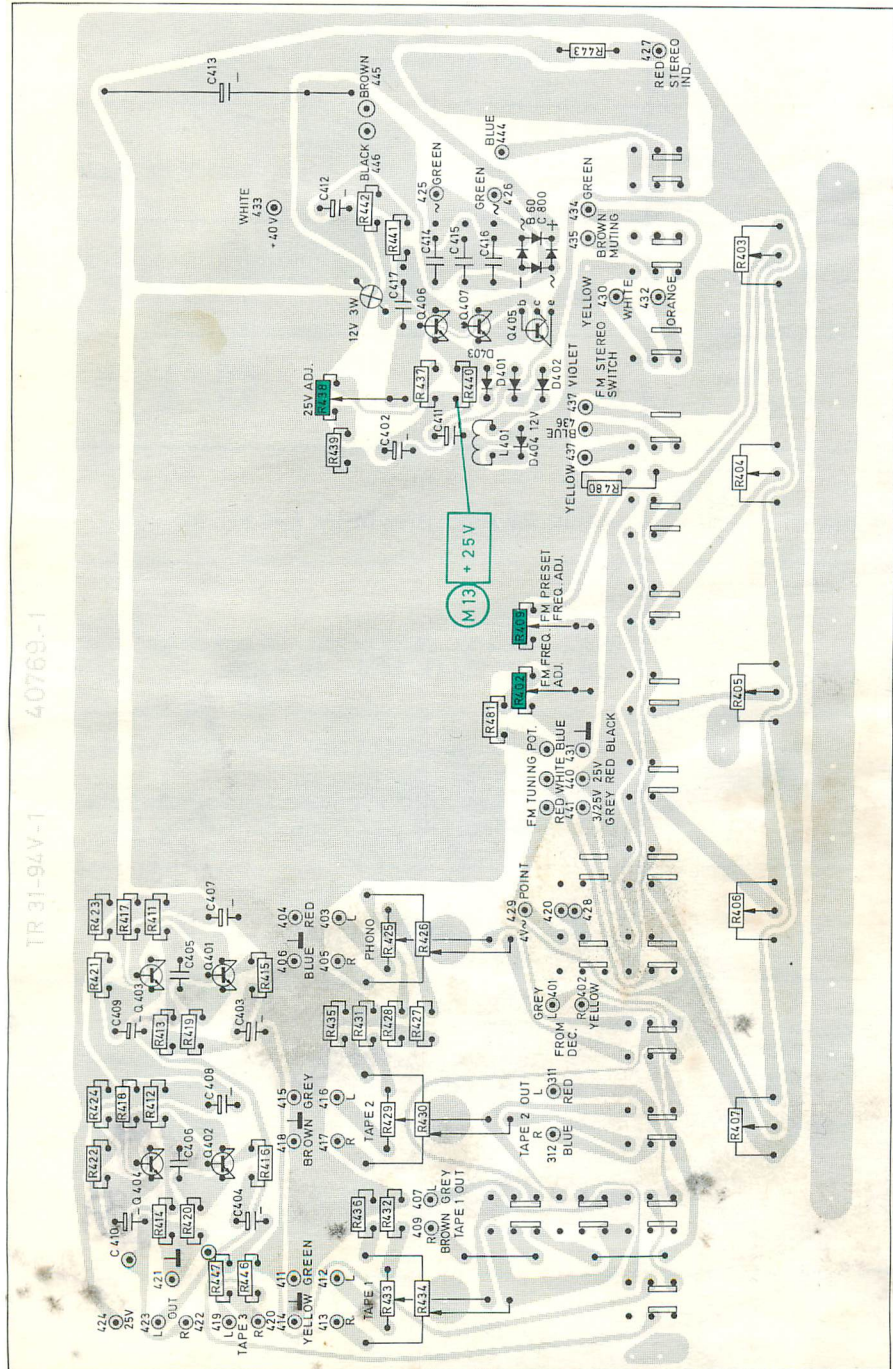







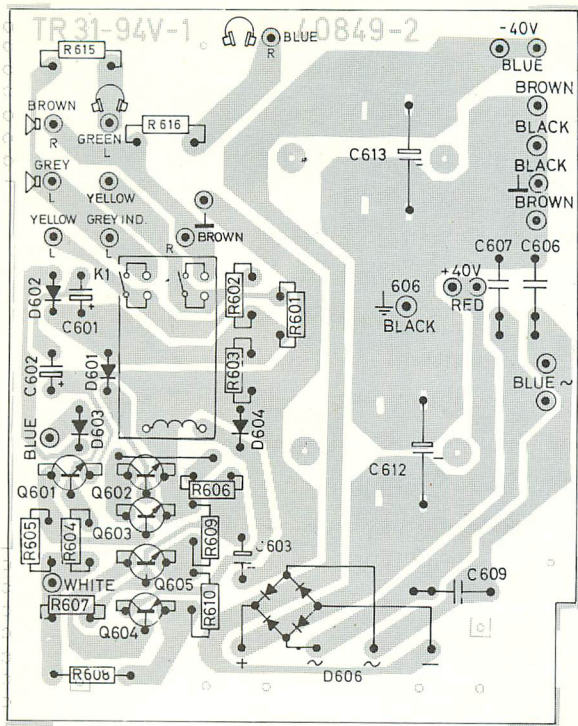

**A6**

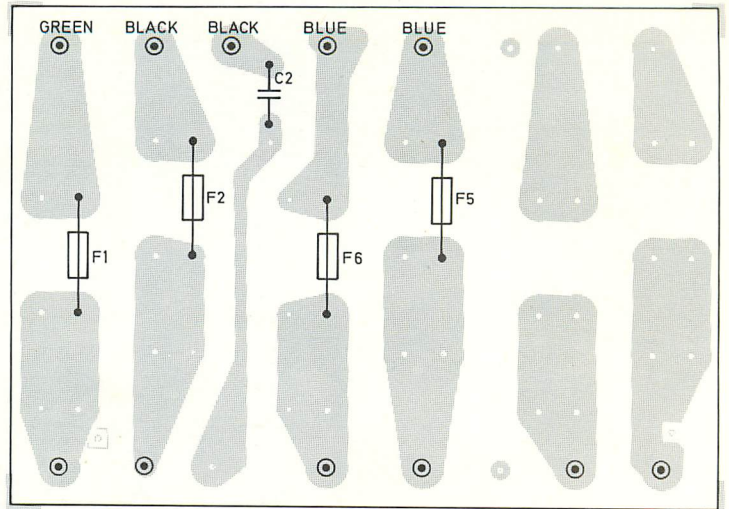

**A9**

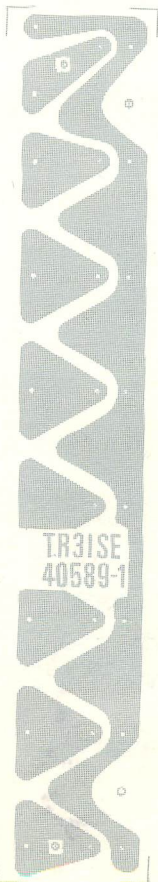

**A10**

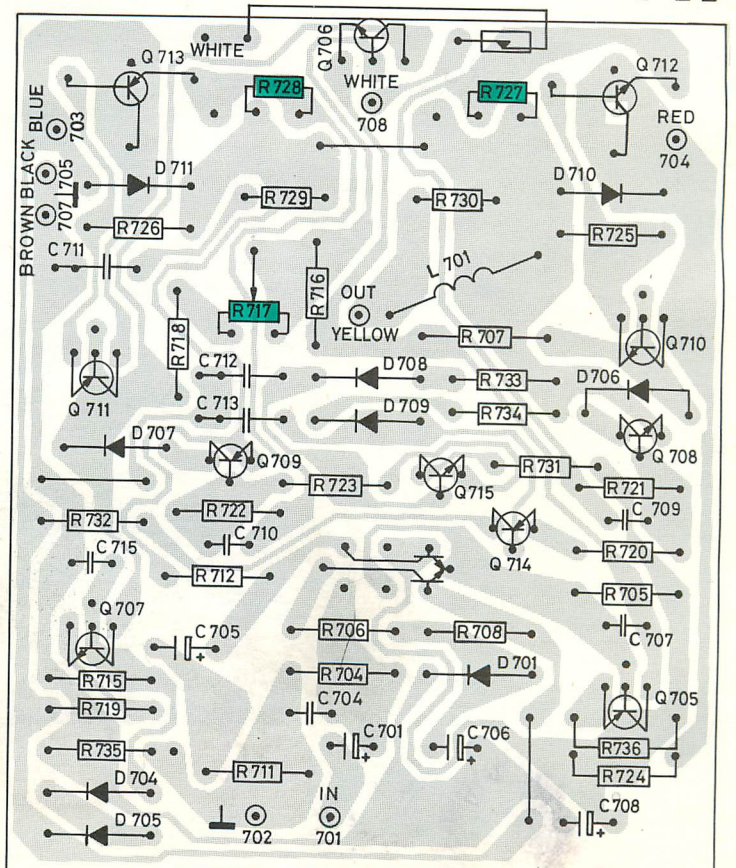

**A7**

TR31-94V-1

42016-4



## 1.0 ALIGNMENT OF STEREO-DECODER

### 1.1 Complete alignment.

A complete alignment involves adjustment of

- The decoder oscillator; 19 kHz (paragraph 1.2)
- Channel separation (paragraph 1.2.1).
- 19 kHz filter (paragraph 1.2.2)
- Stereo/mono switching threshold (paragraph 1.2.3)
- **Definition:** Pilotsignal 19 kHz ( $\pm 2$  Hz).

The following equipment is needed for a complete adjustment:

- FM stereo generator
- Oscilloscope with sensitivity 5 mV/cm
- Frequency counter
- Selective voltmeter or a.c. voltmeter and 20 kHz low pass filter

### 1.2 The decoder oscillator: 19 kHz.

Apply a 1 mV signal from the FM stereo generator, unmodulated.

Adjust R808 so that the frequency counter connected to M801 indicates 19 kHz.

**Alternative method:** This adjustment can be carried out without a frequency counter as follows: Apply a 1 mV signal from the FM stereo generator, modulated with 10% pilotsignal.

Turn R808 slowly from one extreme to the point where the stereo indicator lights up. Turn further in the same direction until the light goes out. Then turn in the opposite direction to set R808 in the middle of the range where the indicator lights.

#### 1.2.1 Channel separation:

Apply a 1 mV signal to the antenna input from the FM stereo generator and set the generator for 10% pilotsignal. Modulate the right channel with 1 kHz at 30% deviation. Connect the oscilloscope to the TAPE OUT socket, of the left channel and adjust R840 to minimum deflection.

Check this adjustment with the 1 kHz signal in the left channel and measure the output of the right channel.

**Alternative method:** Adjust R840 for minimum signal in the left (right) speaker when receiving a test FM stereo transmission with signal in the right (left) channel only.

#### 1.2.2 19 kHz filter.

Apply a 1 mV signal from the FM stereo generator to the antenna input and set the generator for 10% pilotsignal.

Adjust R833 and R835 (R834 and R836) alternatively for minimum signal at the left (right) TAPE OUT. Use a selective voltmeter or an a.c. voltmeter with a low pass filter at 20 kHz to avoid signal components at 38 kHz causing a false indication.

#### 1.2.3 Stereo/mono switching threshold.

Apply a 10  $\mu$ V signal from the FM stereo generator to the 75 ohm antenna input and adjust the generator for 10% pilotsignal. Set R221 fully counterclockwise (seen from the component side) and then turn R221 slowly clockwise until the stereo indicator lights up.

**Note!** If a FM stereo generator is not available an ordinary FM generator can be used for this adjustment. In this case it may be necessary to check the modulation frequency (19 kHz) with the frequency counter.

#### Alignment of FM-section

See the FM-alignment procedure in table and the oscillograms.

Table, FM-alignment.

Step	Alignment procedure	Receiver	
		Frequency	Frequency
1	FM-oscillator		
1A	25V for varicap		
1B	FM-osc. (FM)	90 MHz 105 MHz	90 MHz 105 MHz
1C	FM-preset (P1)	87.5 MHz 105 MHz	87.5 MHz 105 MHz
2	Aerial circuit	90 MHz 105 MHz	90 MHz 105 MHz
3	FM-IF	90 MHz	90 MHz
4	Discriminator	90 MHz	90 MHz
5	Center tuning meter	90 MHz	90 MHz
6	Field strength indicator	90 MHz	90 MHz
7		90 MHz	90 MHz



Fig. 3 Selectivity FM

SIGNAL:  $U_{in} = 150 \mu V / 75 \text{ ohms}$ ,  $f = 90 \text{ MHz}$ , dev. =  $\pm 200 \text{ kHz}$  applied M1 via ant. plug.

OSCILLOSCOPE: Vert.:  $5 \text{ mV/dev.}$ , Hor.:  $50 \text{ kHz/dev.}$  connected to M4 via diodeprobe (Fig. 5).

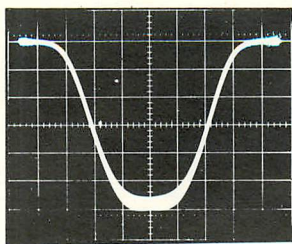

Fig. 4 Discriminator

SIGNAL:  $U_{in} = 2 \mu V / 75 \text{ ohms}$ ,  $f = 90 \text{ MHz}$ , dev. =  $\pm 200 \text{ kHz}$  applied M1 via ant. plug.

OSCILLOSCOPE: Vert.:  $0.2 \text{ v/dev.}$  Hor.:  $50 \text{ kHz/dev.}$  connected to TAPE OUT (M6).

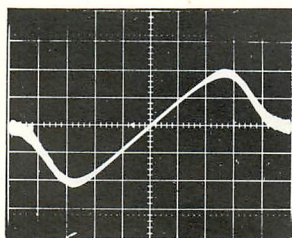
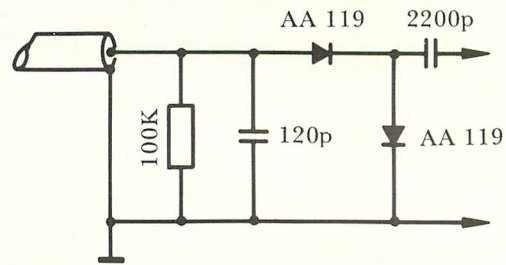
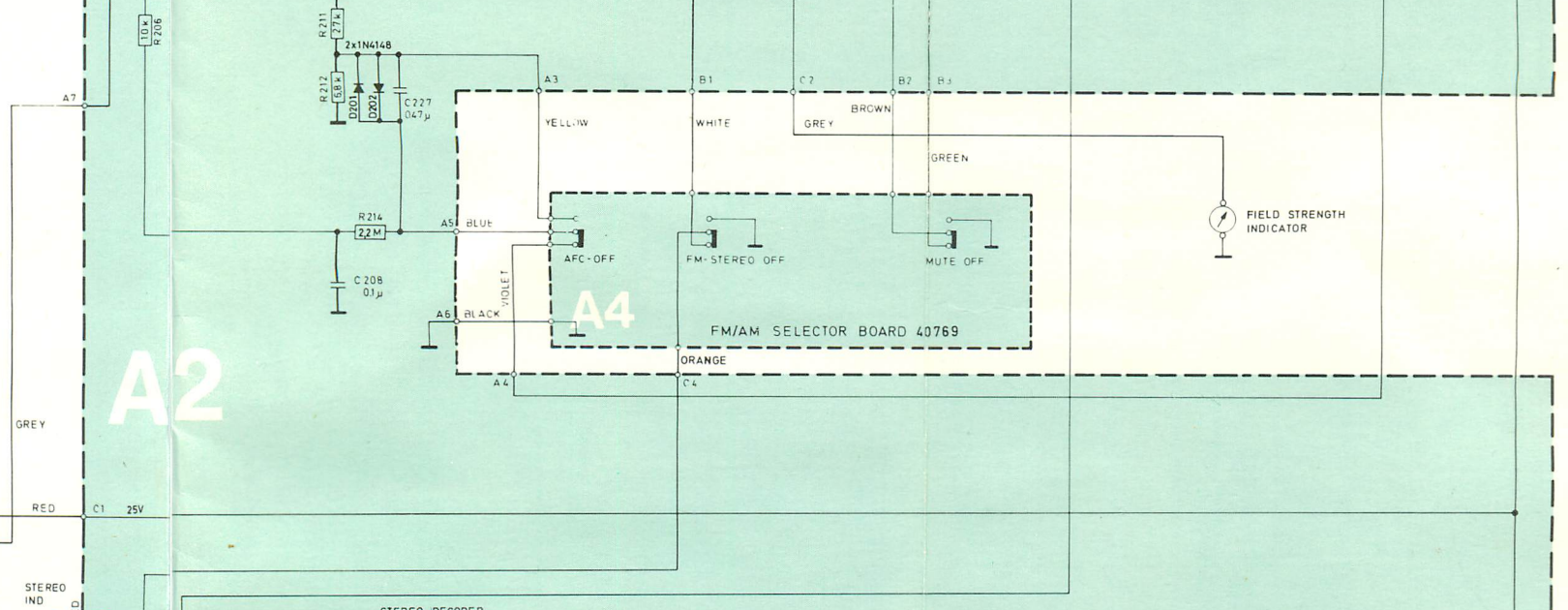
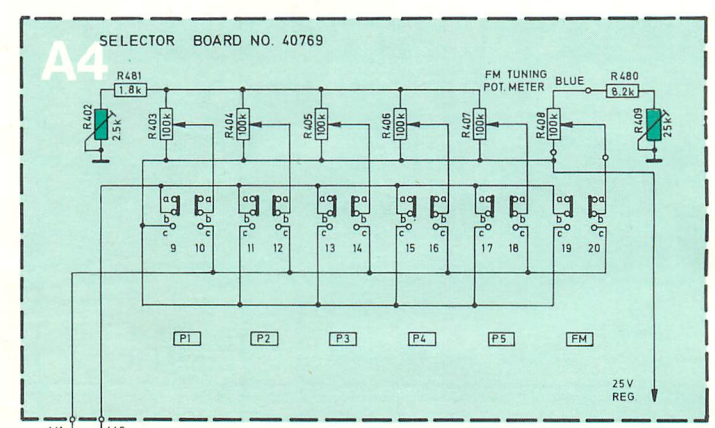
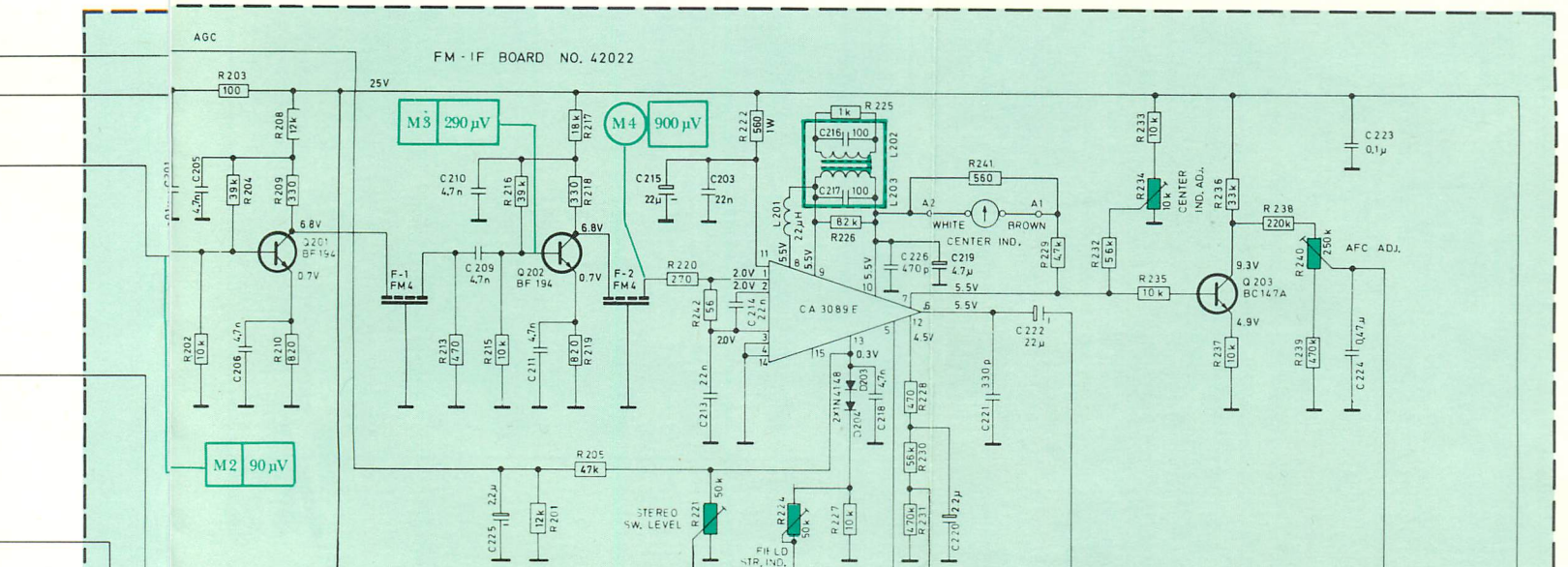
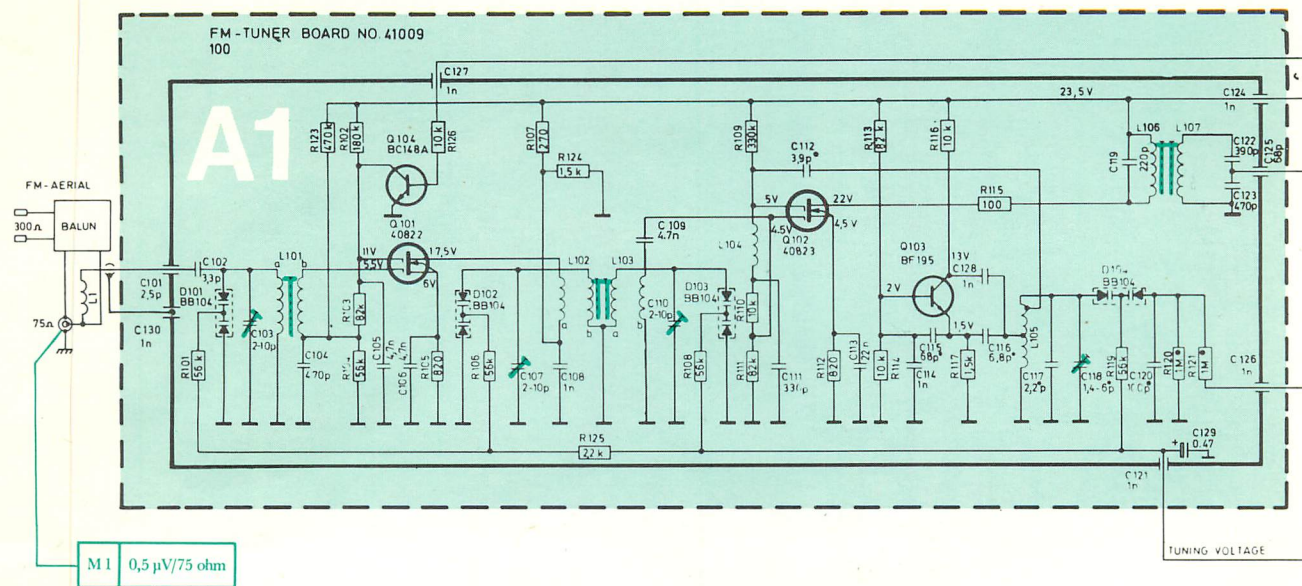

Fig.5 Diodeprobe.



Generator		Oscilloscope	Circuits	Notes
Deviation	Applied to	Connected to	Adjust	
				AFC-button depressed
			R 438	Meter connected to M13 Adjust to 25 V DC reading
$\pm 22.5 \text{ kHz}$	M 1	M 4 via diodeprobe ( fig. 5 )	R 409 C 118	Check 95 and 100 MHz
$\pm 22.5 \text{ kHz}$	M 1	M 4 via diodeprobe ( fig. 5 )	R 402	Check P2 - P3 - P4 - P5
$\pm 200 \text{ kHz}$	M 1	M 4 via diodeprobe ( fig. 5 )	L101, L102, L103 C103 C107, C110	Adjust for max. curve height (see Fig. 3).
$\pm 200 \text{ kHz}$	M 1	M 4 via diodeprobe ( fig. 5 )	L106, L107	Adjust for max. curve height and symmetry (see Fig. 3) FM-IF 10.6 – 10.8 MHz.
$\pm 75 \text{ kHz}$	M 1 1 mV/75 ohm		L 202, L 203	Voltmeter connected to M6: L203 adjust for max. output voltage. Dist./voltm. connected to M6: L202 adjust for min. output voltage and min. distortion (see Fig. 4).
$\pm 75 \text{ kHz}$	M 1 1 mV/ 75 ohm		R 234	Adjust for center position of the pointer
	M 1 50 mV/75 ohm		R 224	Adjust R224 for 80-90% max. meter reading at a signal voltage of about 50 mV.
$\pm 75 \text{ kHz}$	M 1	M 4 via diodeprobe ( fig. 5 )	R 240	The curve should remain stationary when the AFC-button is released.





RESISTANCE VALUES ARE OHMS k=1000, M=1000000. RESISTORS ARE 0.5WATT OR LESS UNLESS OTHERWISE SPECIFIED. ALL SWITCHES ARE DRAWN IN UNOPERATED POSITION. ALL RESISTORS ARE DRAWN IN UNOPERATED POSITION. CAPACITORS MARKED WITH A DOT ARE LOW NOISE TYPES. CAPACITORS MARKED WITH A DOT HAVE A SPECIFIED TEMPERATURE COEFFICIENT.

C 112 33pF N 33  
 C 115 0.01uF N 750  
 C 116 0.01uF N 750  
 C 117 2.2pF N 100  
 C 118 1.4-6pF N 100  
 C 120 100pF N 750 (N1500 USED IN SOME CASES)

SUBJECT TO CHANGES WITHOUT FURTHER NOTICE

All selectors are shown in unoperated position.

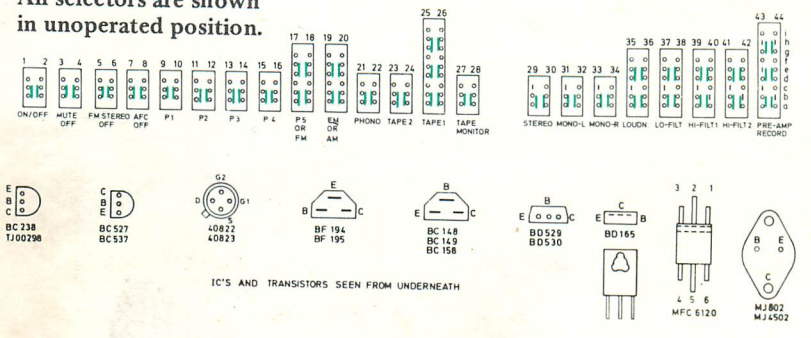

Tuner section. 40859

1/ C809 and C810 are 15n in US models.



RESISTANCE VALUES ARE OHMS  $\times 1000$ , M=1000000. RESISTORS ARE 0.5WATT OR LESS UNLESS OTHERWISE SPECIFIED. ALL SWITCHES ARE DRAWN IN UNOPERATED POSITION. ALL RESISTORS MARKED WITH A DOT ARE LOW NOISE TYPES. 1) SWITCH-NOISE SUPPRESSOR.

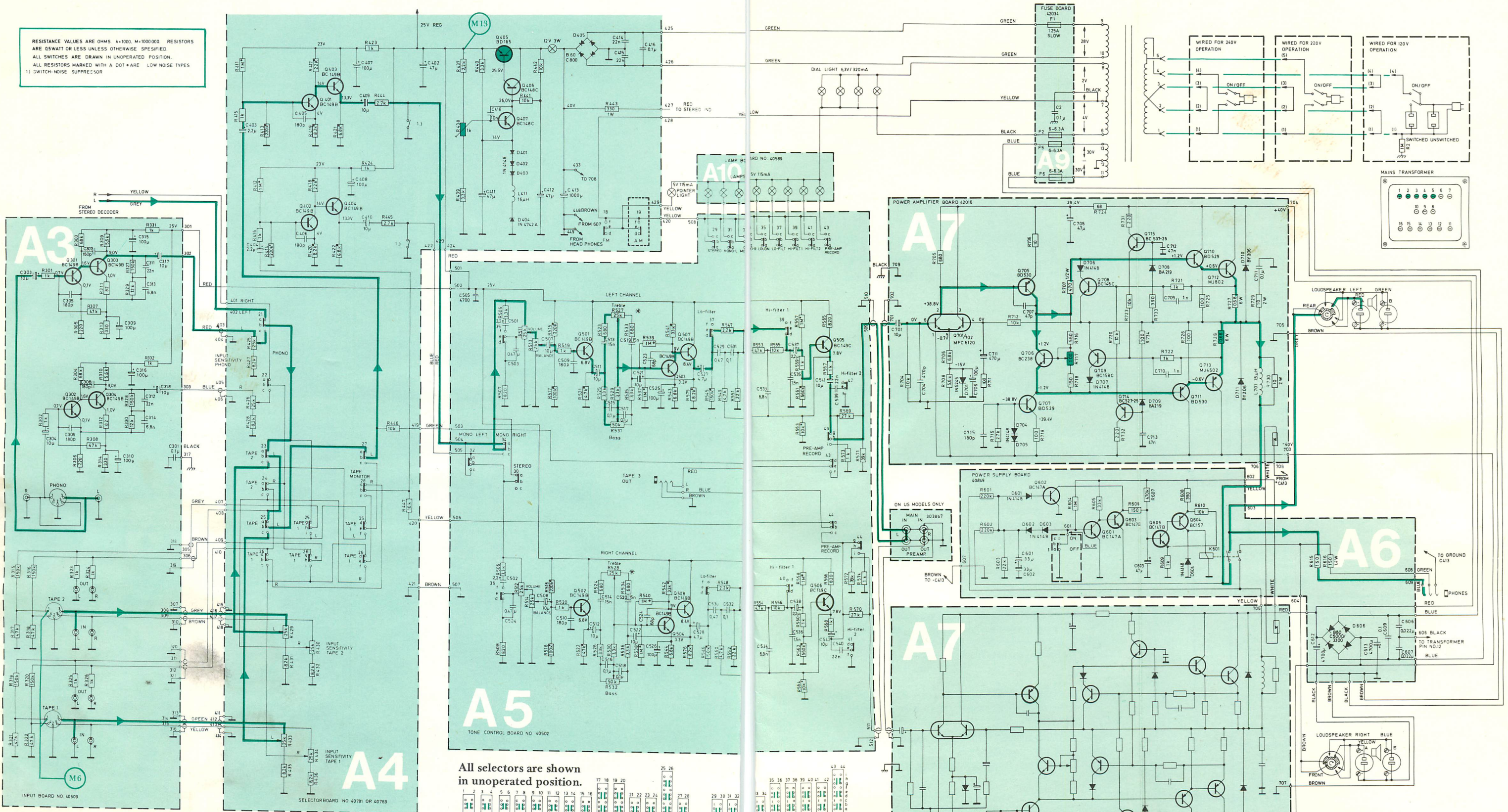

**Quiescent current.**

The quiescent current in both channels can be checked by measuring the voltage across R728. Immediately after power has been switched on and with the volume at minimum the voltage should be 25 mV. If necessary, adjust with R717. After 10 minutes warm-up the voltage will normally be 40 mV.

The most convenient place to connect the voltmeter is between the top of R727 and the top of R728 (on the component side of the board).

All selectors are shown in unoperated position.

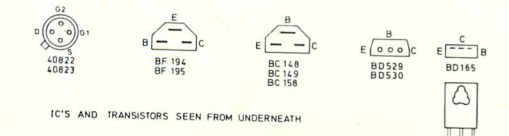
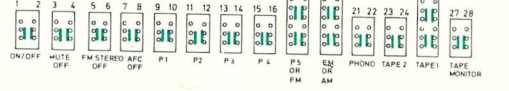



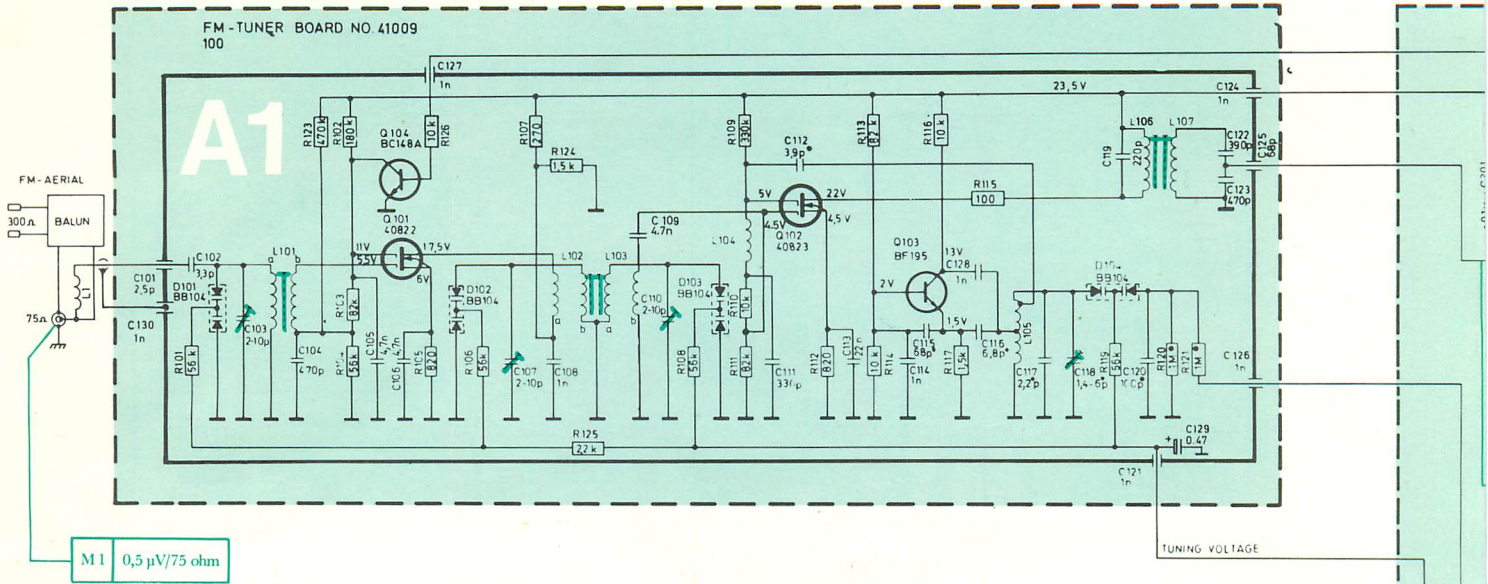

M1 0,5 μV/75 ohm

TUNING VOLTAGE

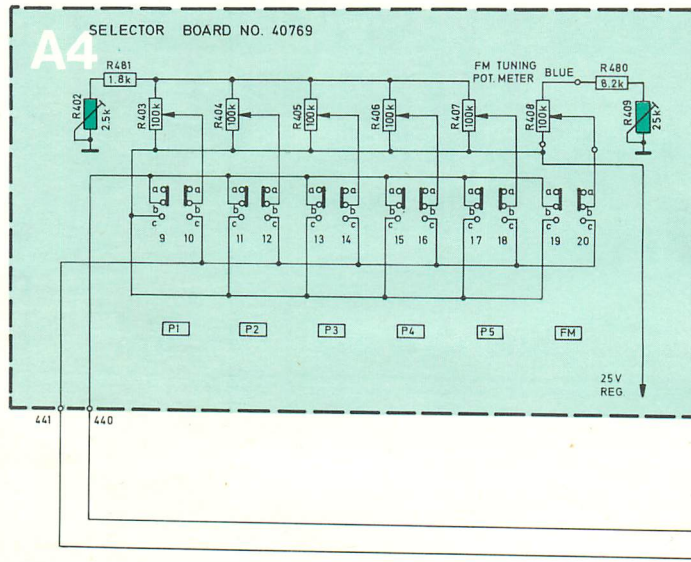

GREY  
RED  
C1 25V

RESISTANCE VALUES ARE OHMS k=1000, M=1000000. RESISTORS ARE 0.5WATT OR LESS UNLESS OTHERWISE SPECIFIED. ALL SWITCHES ARE DRAWN IN UNOPERATED POSITION. ALL RESISTORS MARKED WITH A DOT • ARE LOW NOISE TYPES. CAPACITORS MARKED WITH A DOT • HAVE A SPECIFIED TEMPERATURE COEFFICIENT.

C112 3.9pF N33  
C115 88pF N 750  
C116 88pF N 750  
C117 2.2pF P 100  
C118 1.4-6pF N 100  
C120 100pF N 750 (IN1500 USED IN SOME CASES)

SUBJECT TO CHANGES WITHOUT FURTHER NOTICE

All selectors are shown in unoperated position.

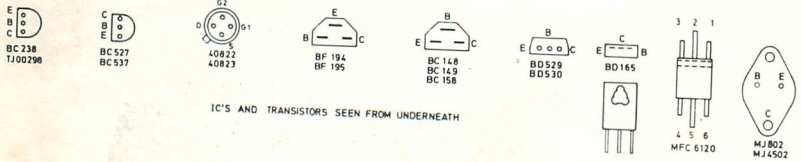
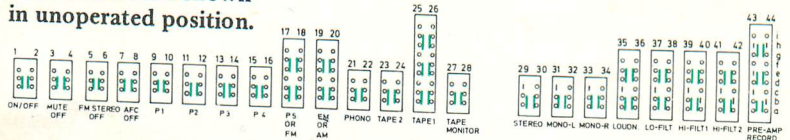

IC'S AND TRANSISTORS SEEN FROM UNDERNEATH

STEREO IND  
RED TO 427  
24V  
50 mA

C80  
47n  
22C  
C80