

TANDBERG

TR 2075 MkII

Ca 2700DM

Circuit diagrams and PW - boards
Skjemaer og TL - kort



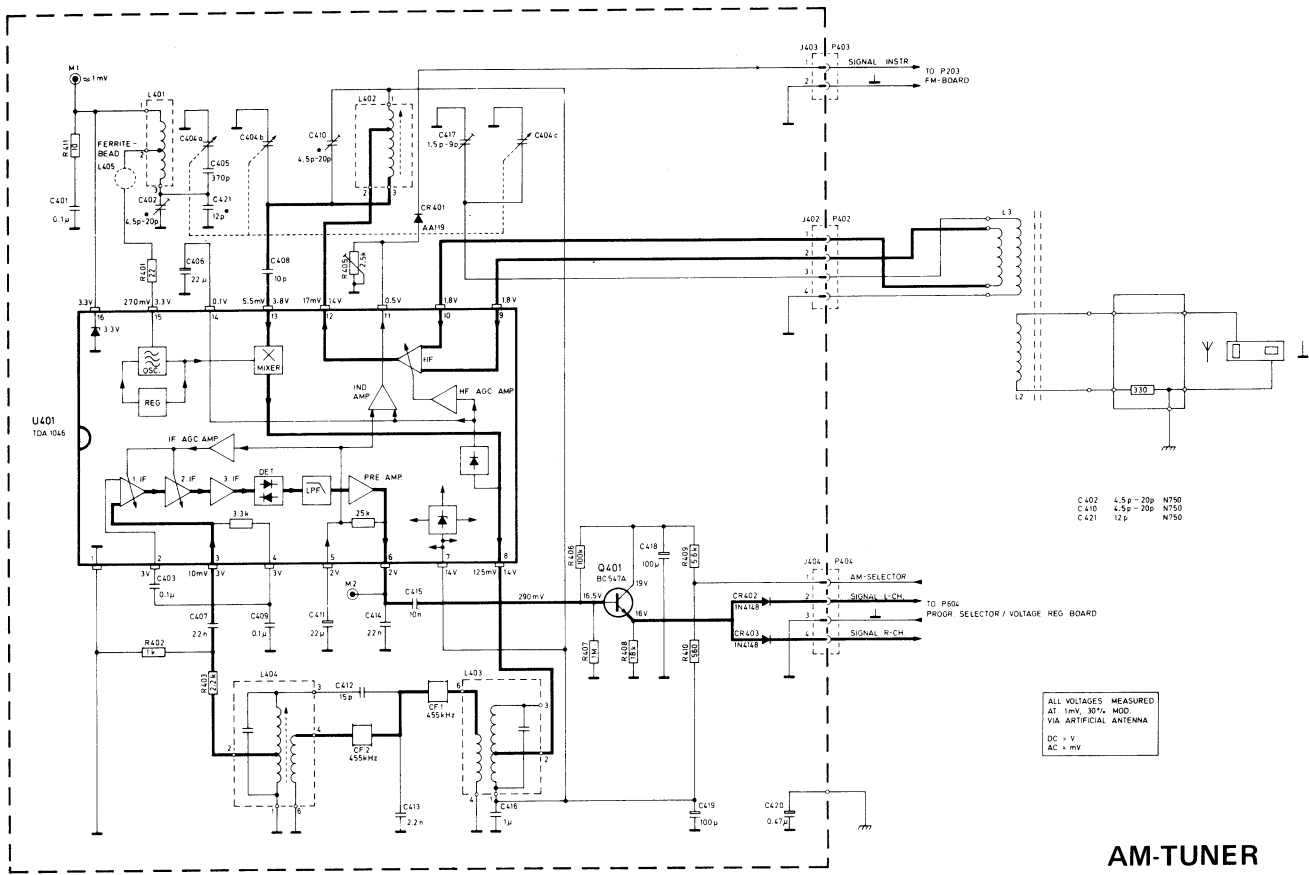

AM-TUNER

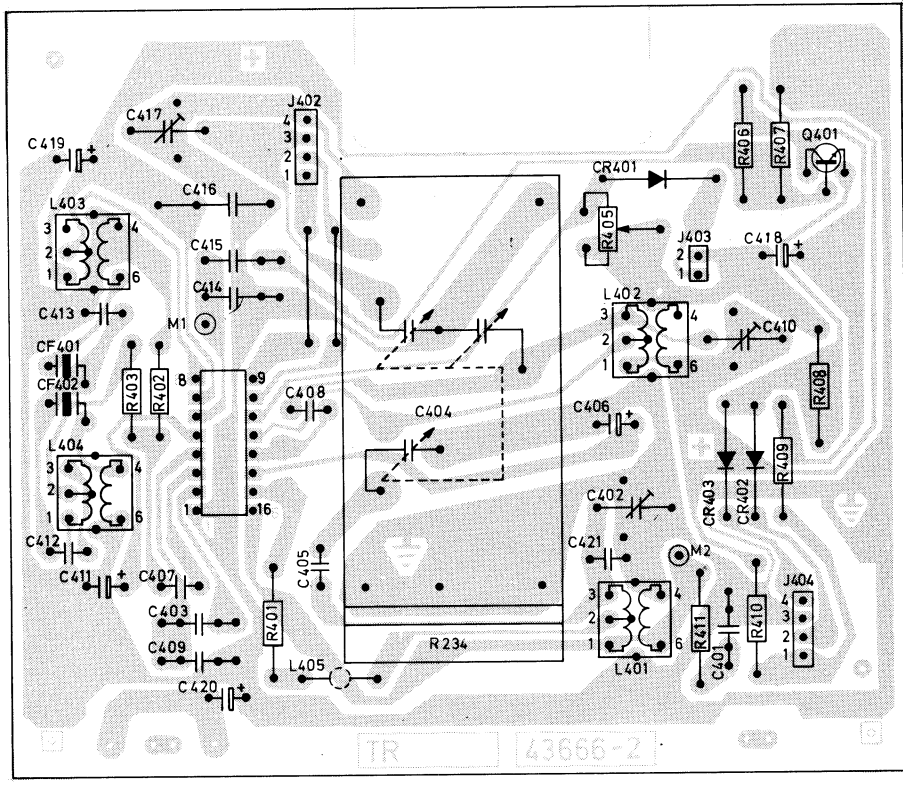

PW-BOARD, AM-TUNER
TL-KORT, AM-TUNER

All PW-boards are seen from the solder side
Alle TL-plater er sett fra loddessiden

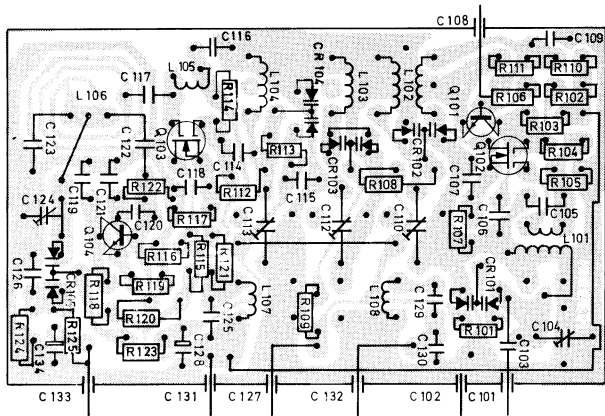
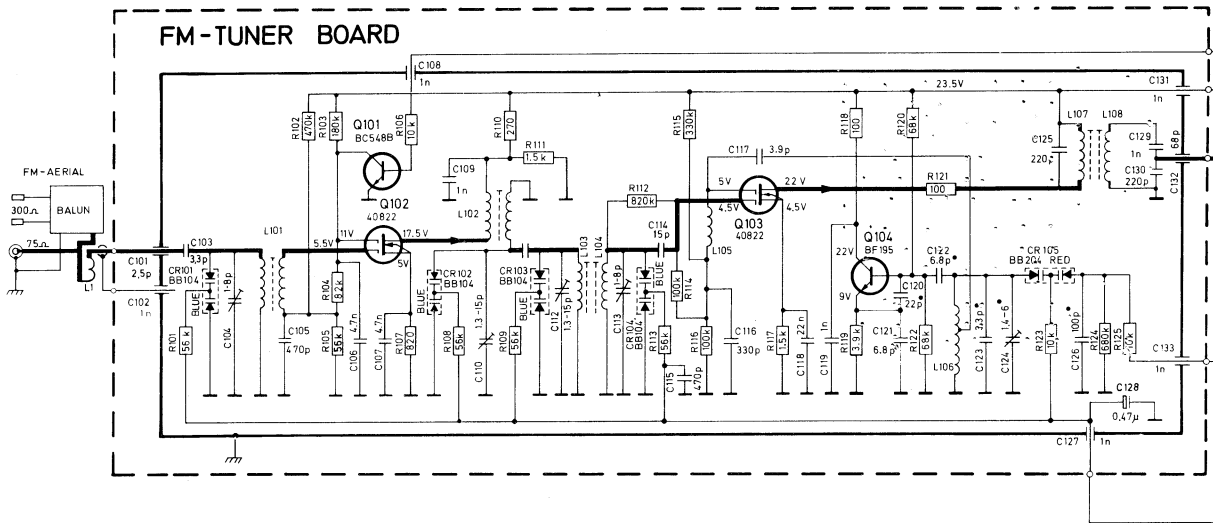

PW-BOARD, FM-TUNER
TL-KORT, FM-TUNER

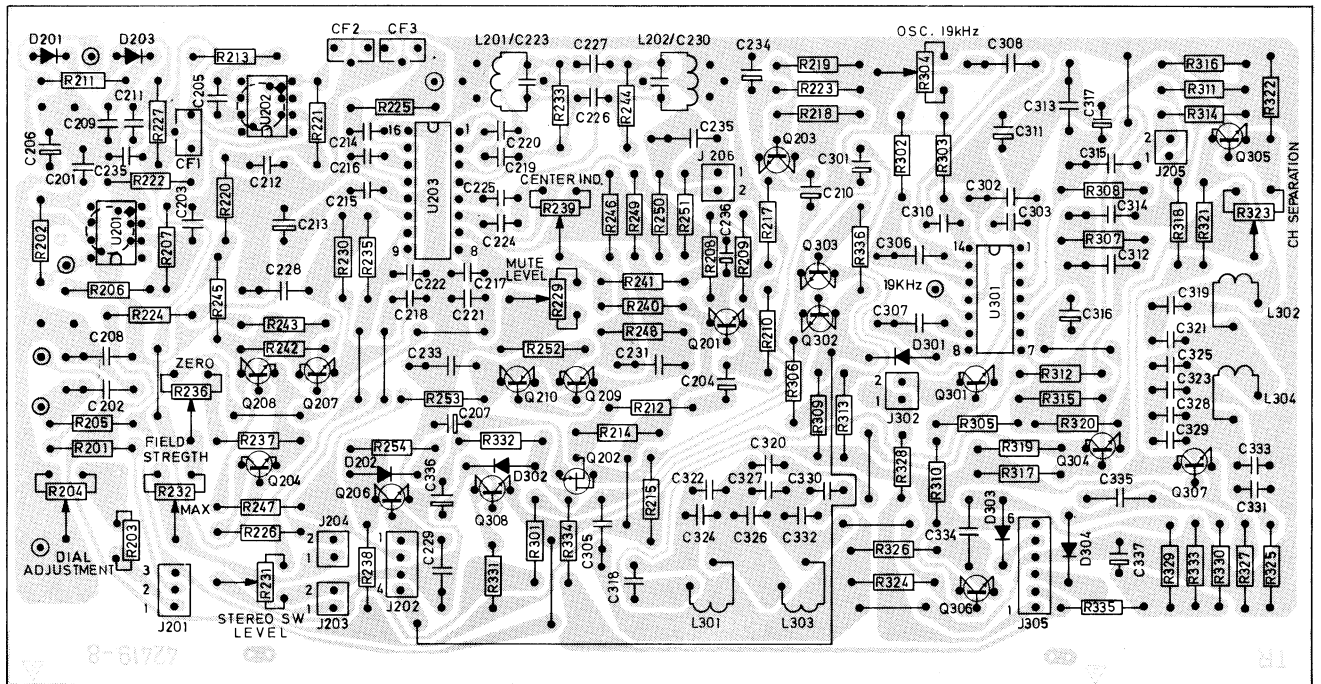

PW-BOARD, FM-IF AND DECODER
TL-KORT, FM-MF OG DEKODER

All PW-boards are seen from the solder side
Alle TL-plater er sett fra loddessiden

FM-IF + DECODER BOARD

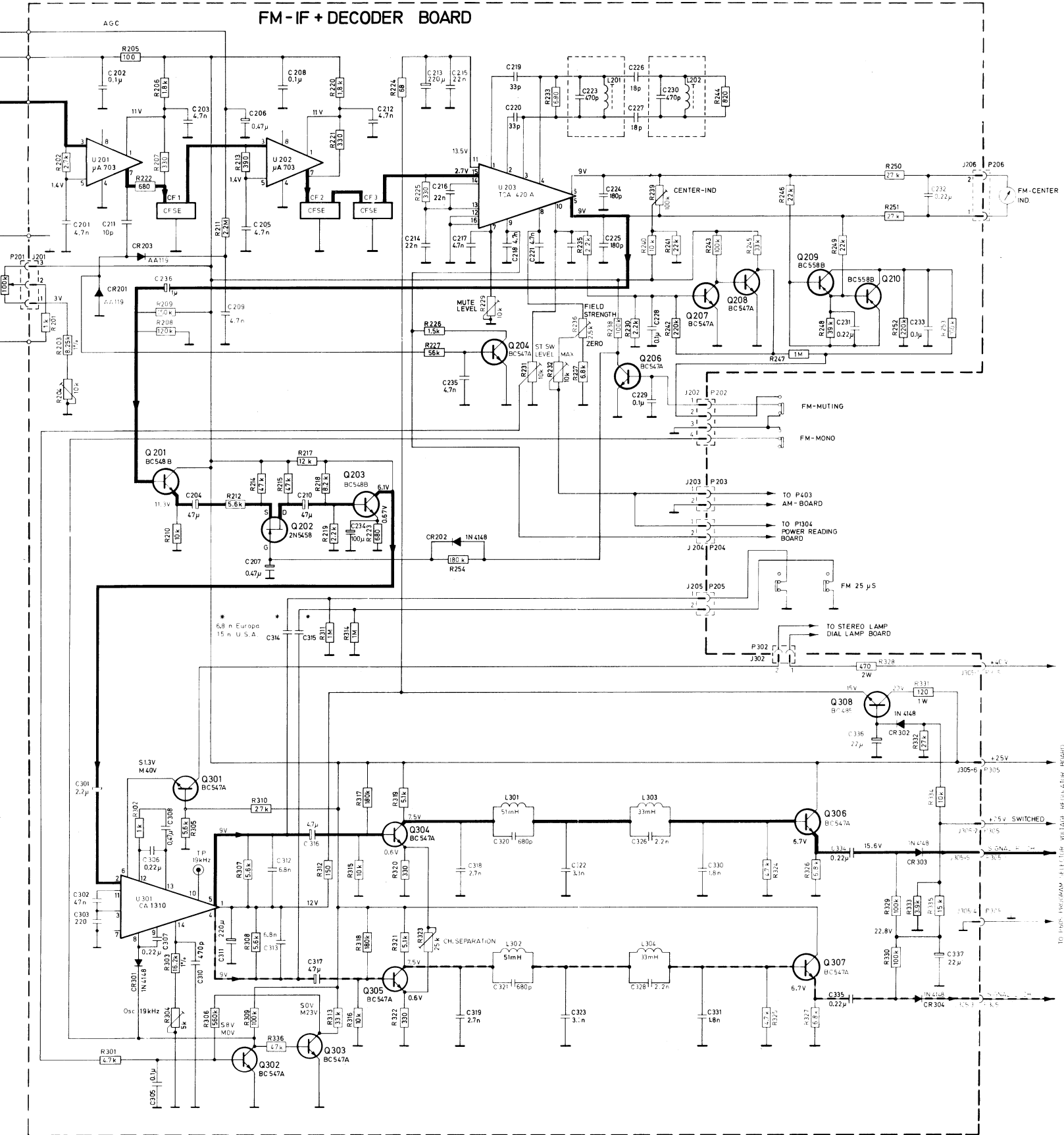

* 6.8 n Europe
15 n U.S.A.

- C117 3.9p N750
- C120 22p N70
- C121 6.8p N750
- C122 6.8p N750
- C123 3.3p N70
- C124 14.5p N70
- C126 100p N1500

- BC 547
- BC 548
- BC 549
- BC 481



FM - TUNER, FM IF AND DECODER
FM - TUNER, FM MF OG DEKODER

ALL TRANSISTORS ARE SEEN FROM UNDERNEATH

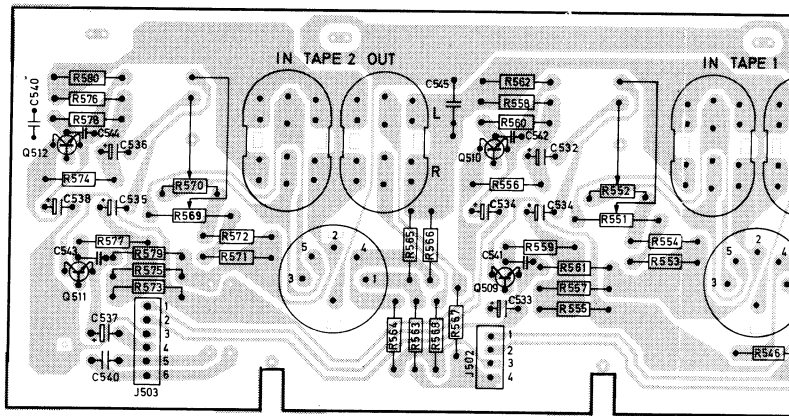

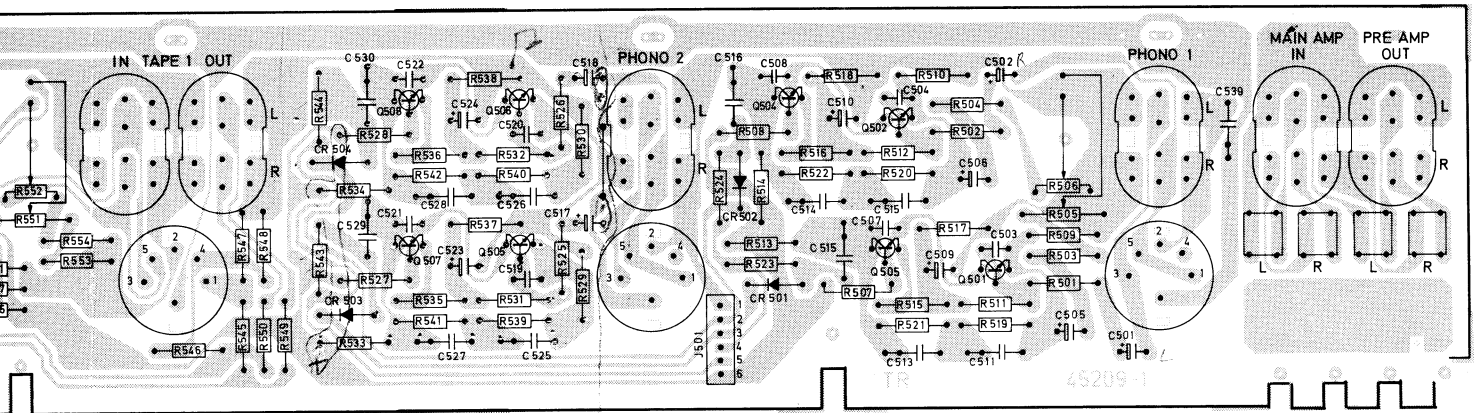

PW-BBOARD, RIAA-AMPLIFIER
TL-KORT, RIAA-FORSTERKER

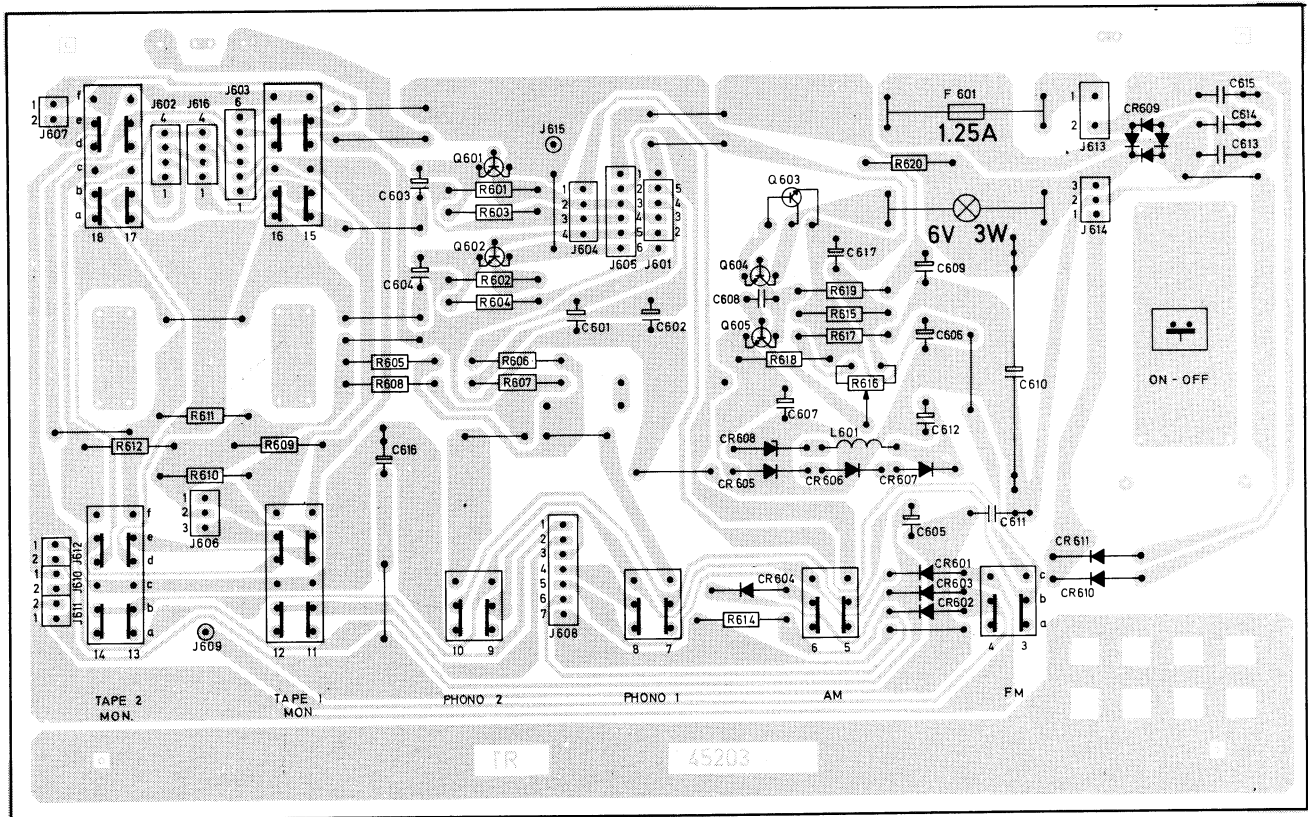

PW-BBOARD, PROGRAM SELECTOR
TL-KORT, PROGRAMVELGER

All PW-boards are seen from the solder side
Alle TL-plater er sett fra loddessiden

RIAA / INPUT AMP. BOARD

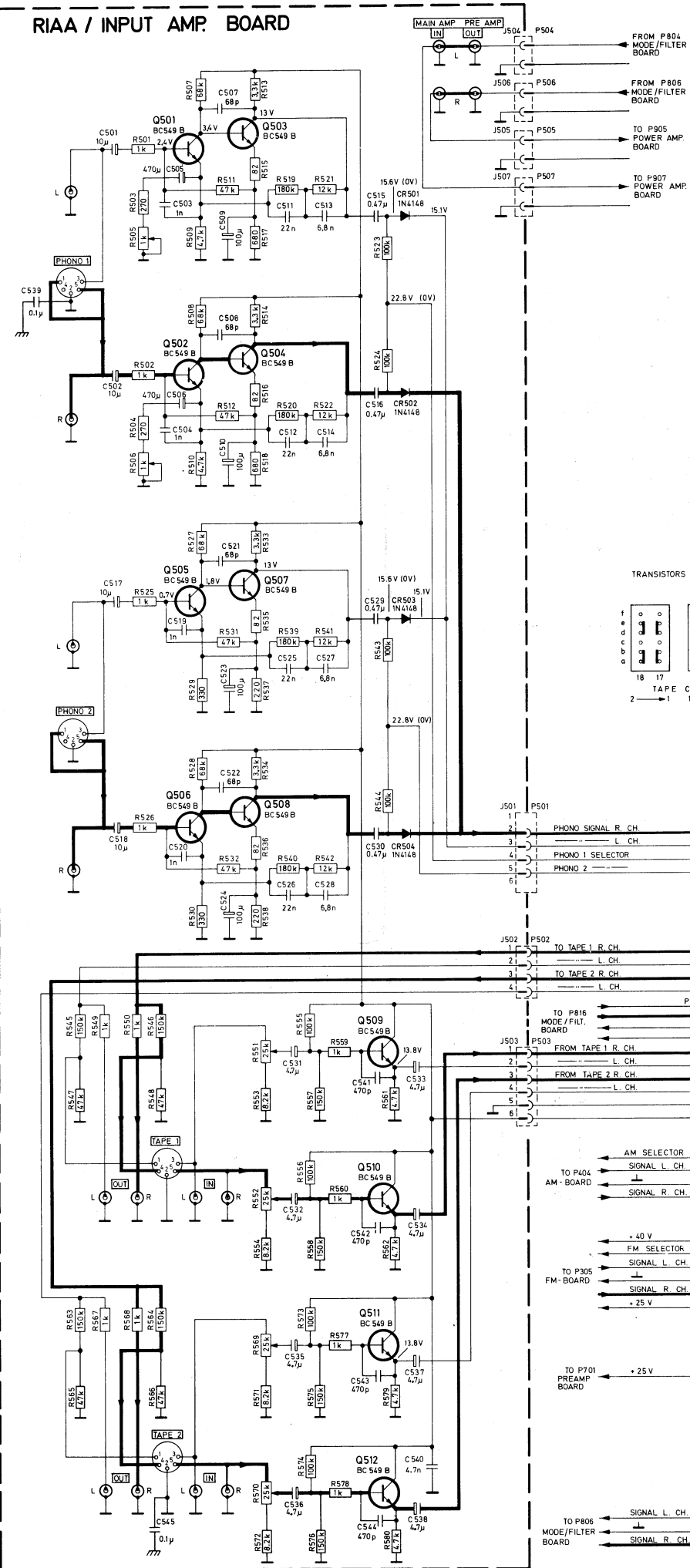

6-50000000-1,5dB

22-16
70V

32V

150-600
mV



TRANSISTORS AND SELECTORS ARE SEEN FROM UNDERNEATH

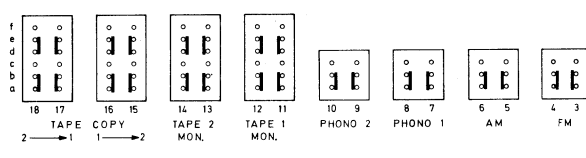

PROGRAM SELECT./VOLTAGE REG. BOARD

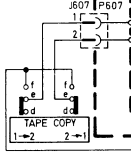
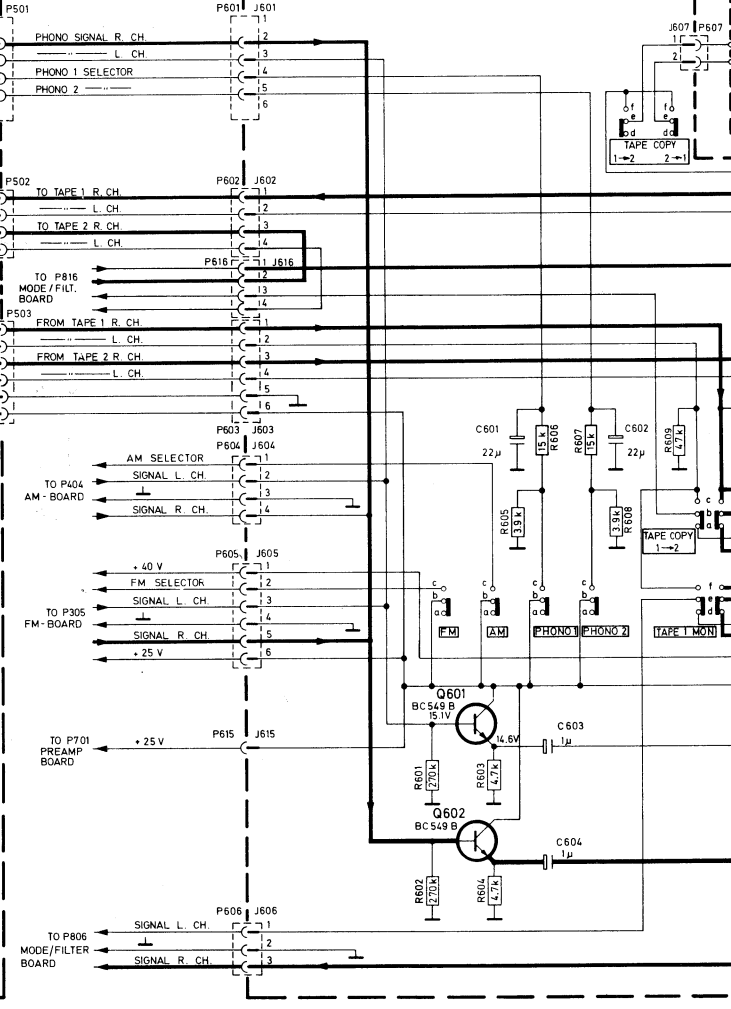

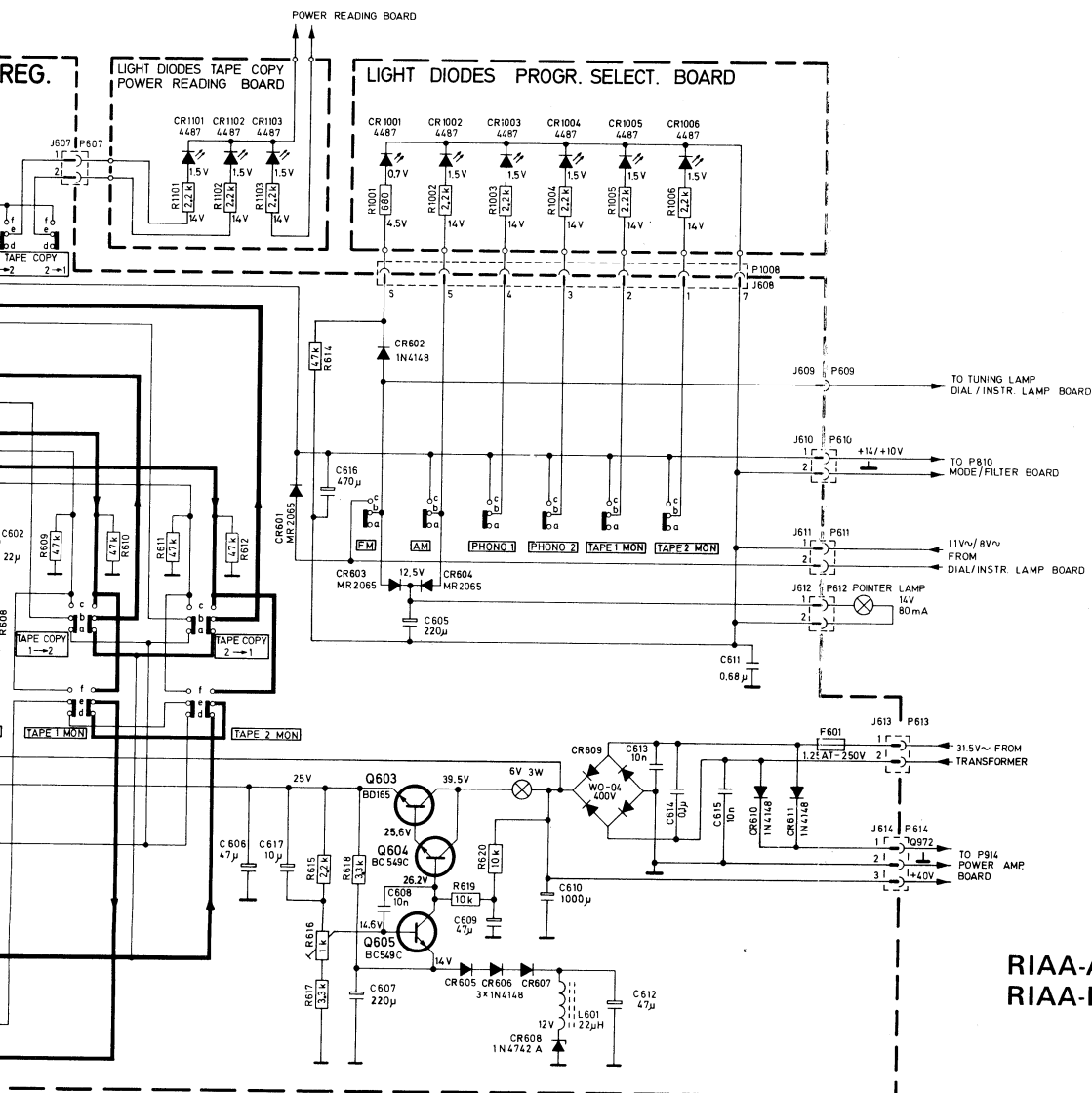

RIAA-AMPLIFIER/PROGRAM SELECTOR
RIAA-FORSTERKER/PROGRAMVELGER

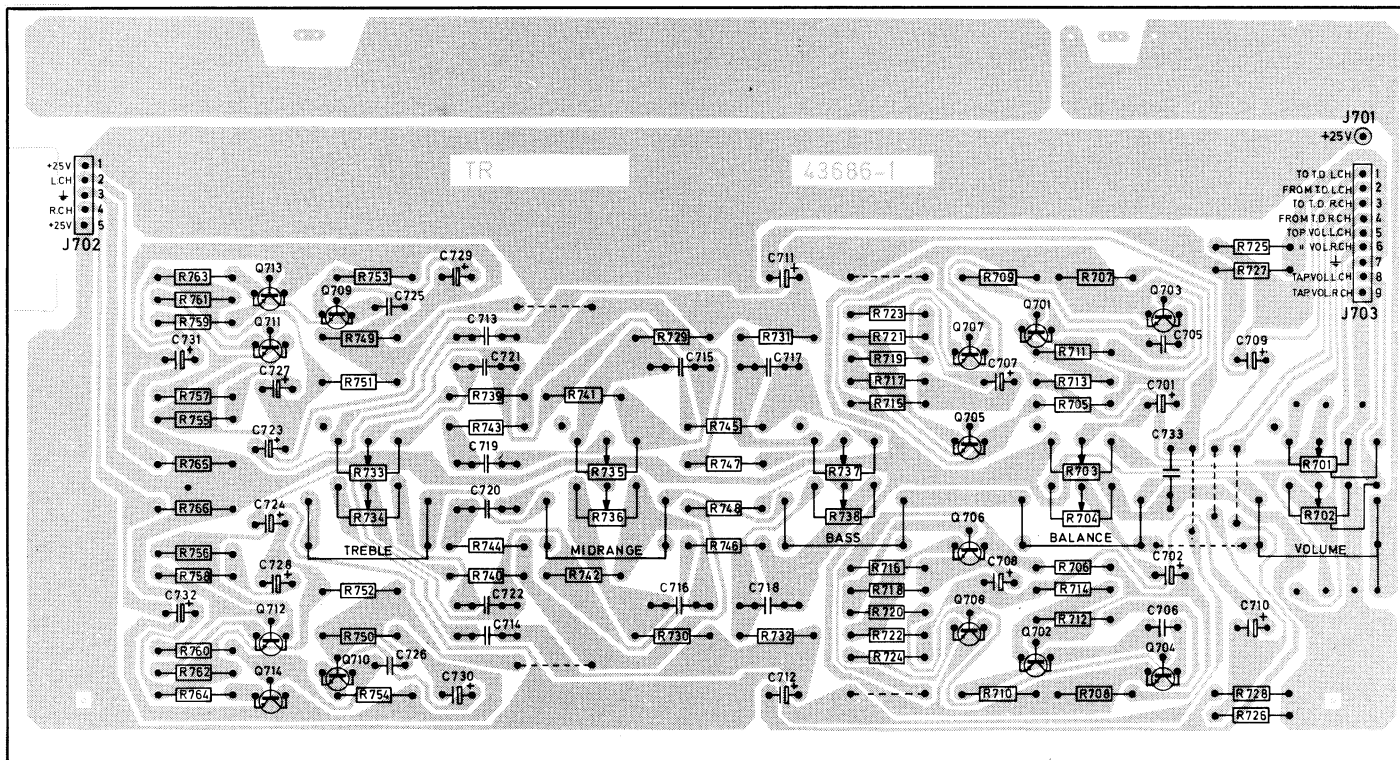

PW-BRD, PREAMPLIFIER/TONE CONTROL
TL-KORT, FORFORSTERKER/TONEKONTROLL

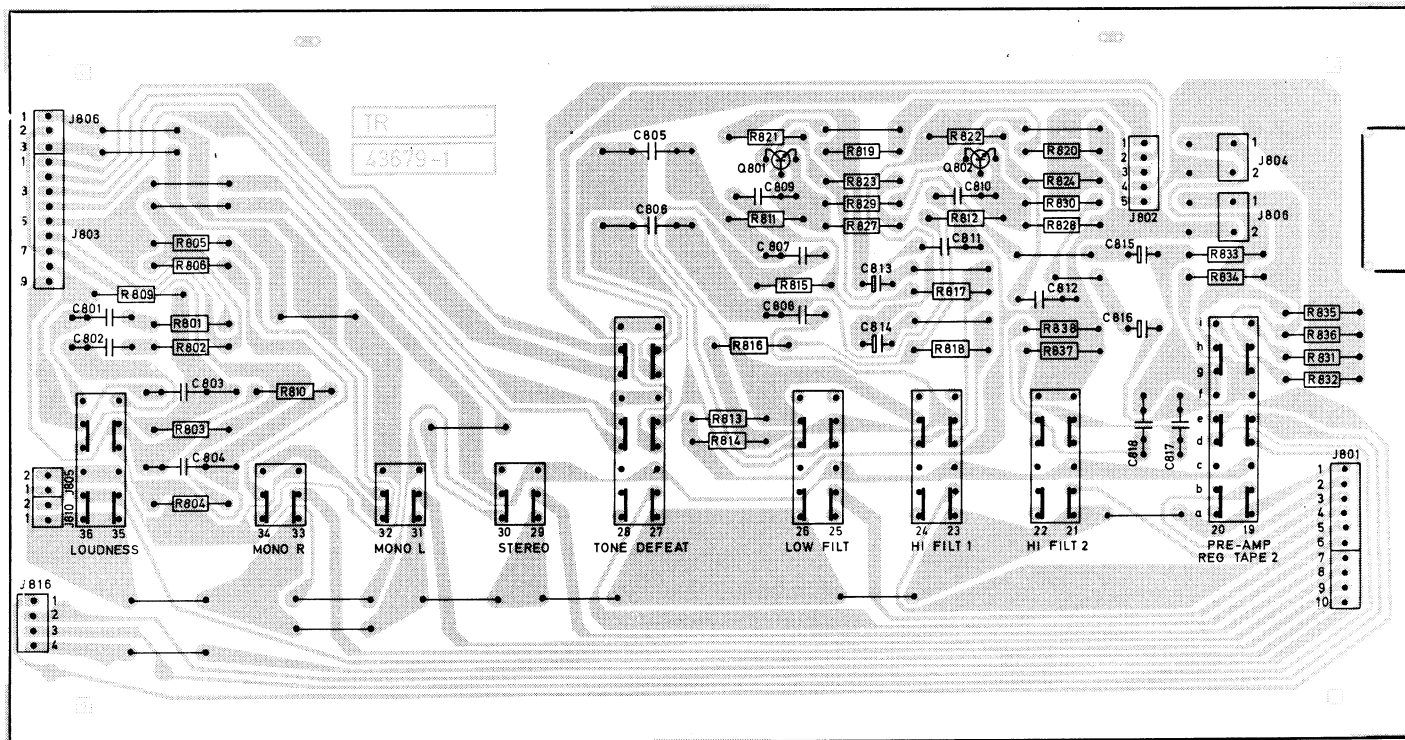

PW-BRD, MODE FILTER
TL-KORT, FILTER

All PW-boards are seen from the solder side
Alle TL-plater er sett fra loddessiden

Höhen 10kHz ± 15dB
 Mitten 1kHz ± 2dB
 Bässe 50Hz ± 15dB

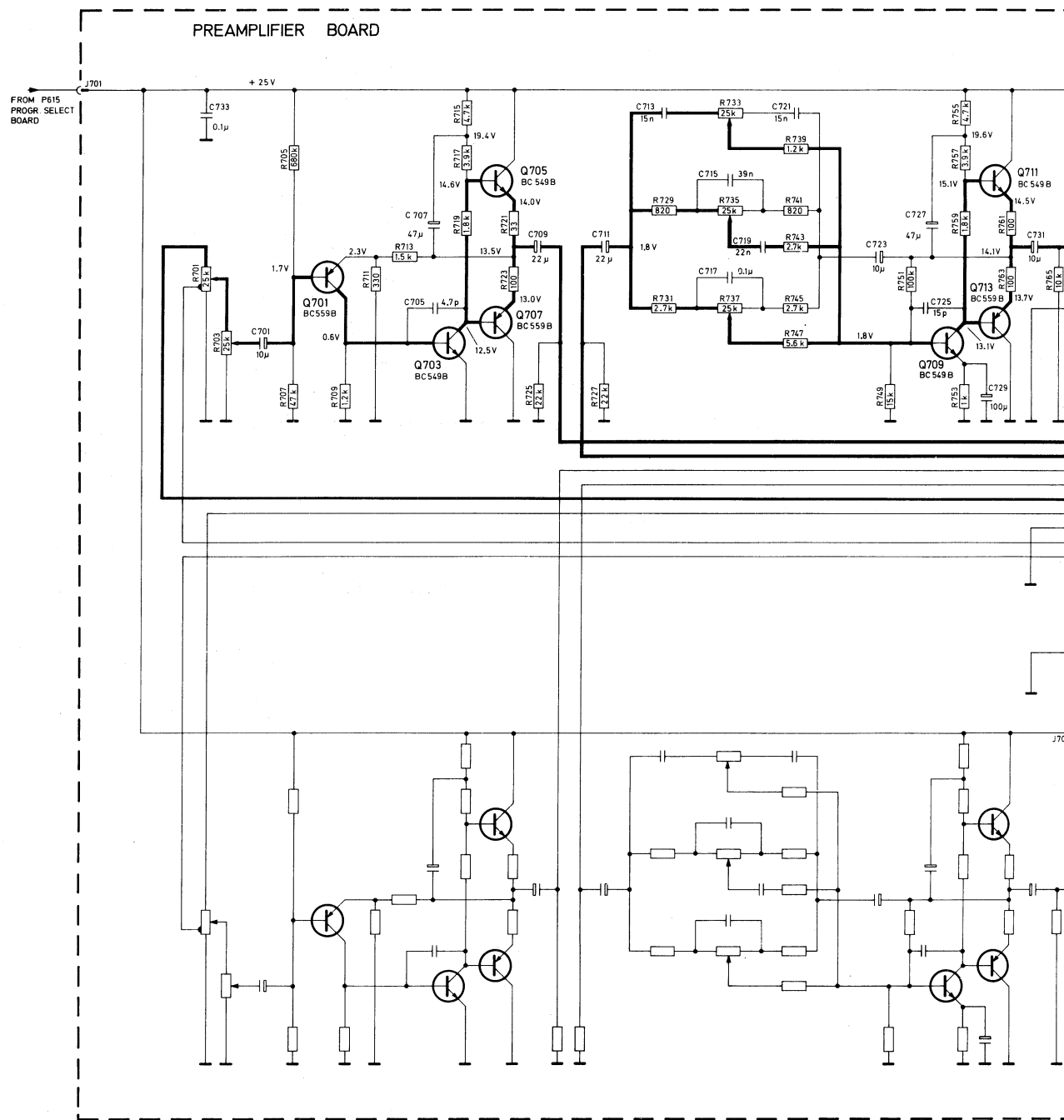

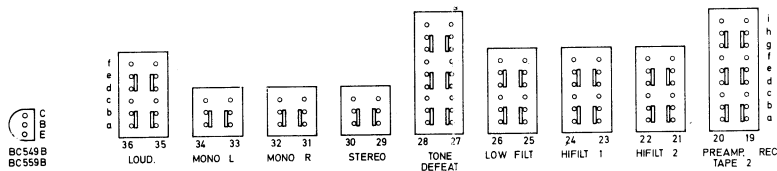
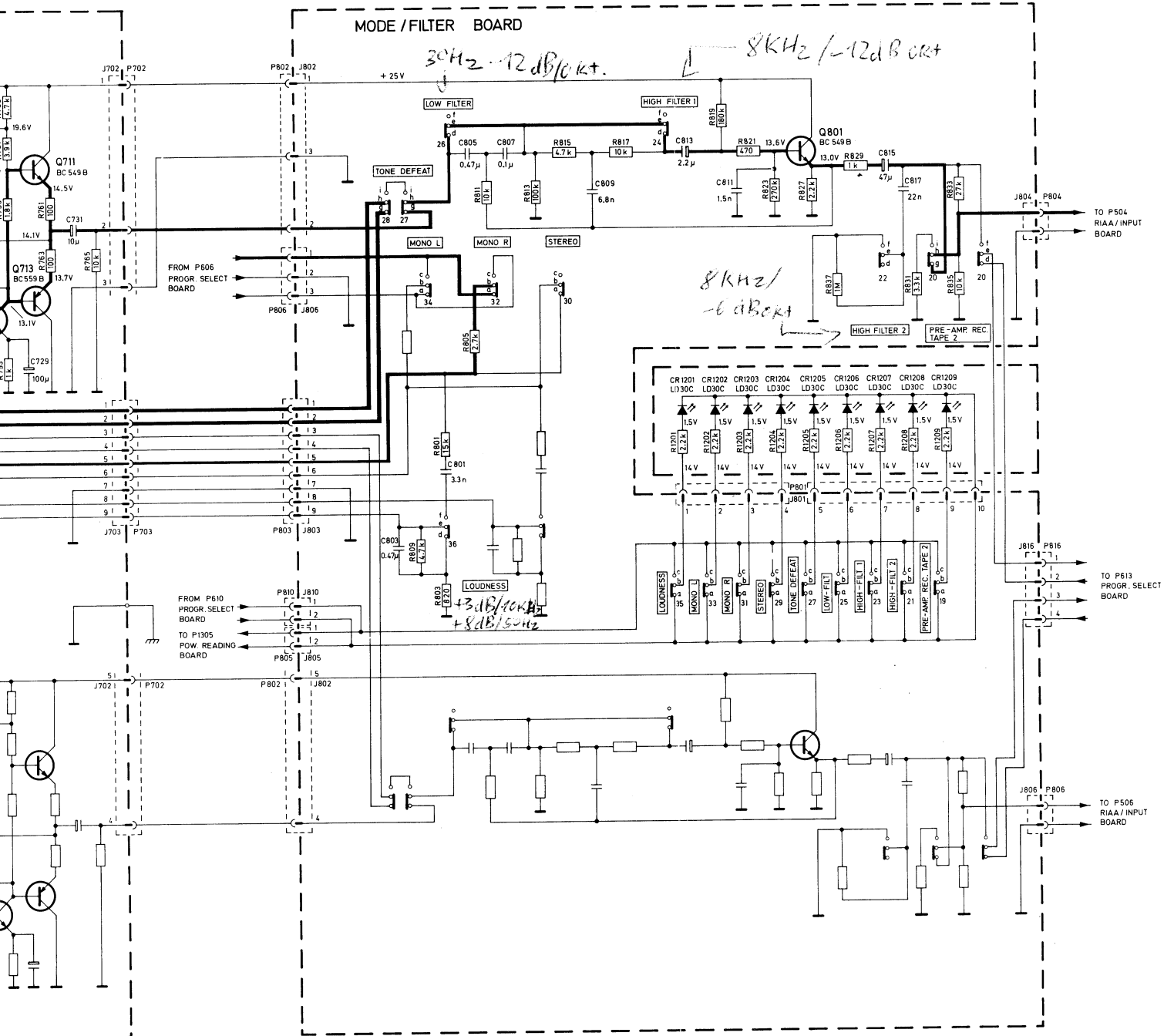

**PREAMPLIFIER/TONE CONTROL/MODE FILTER
FORFORSTERKER/TONEKONTROLL/FILTER**

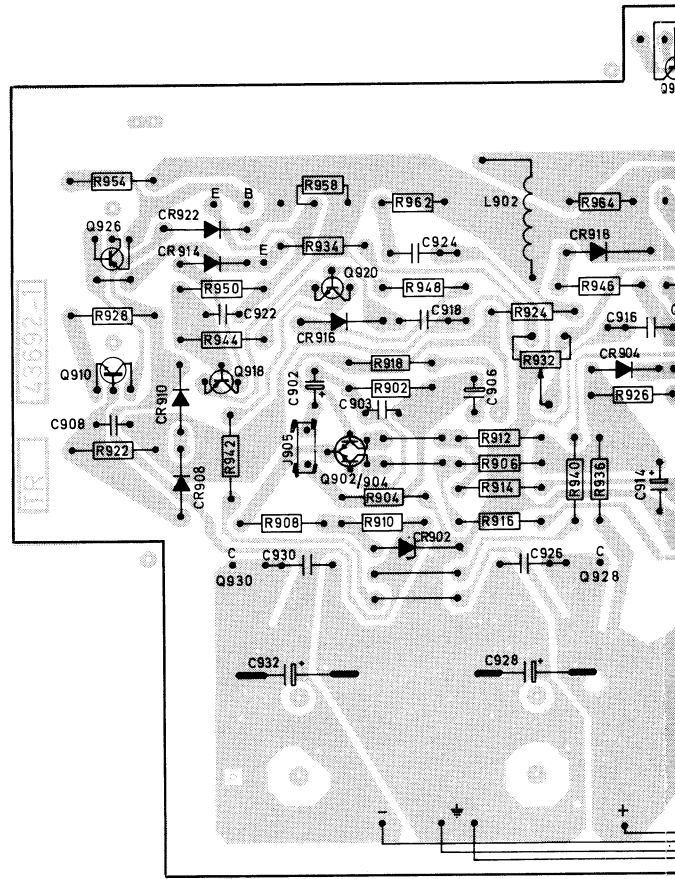

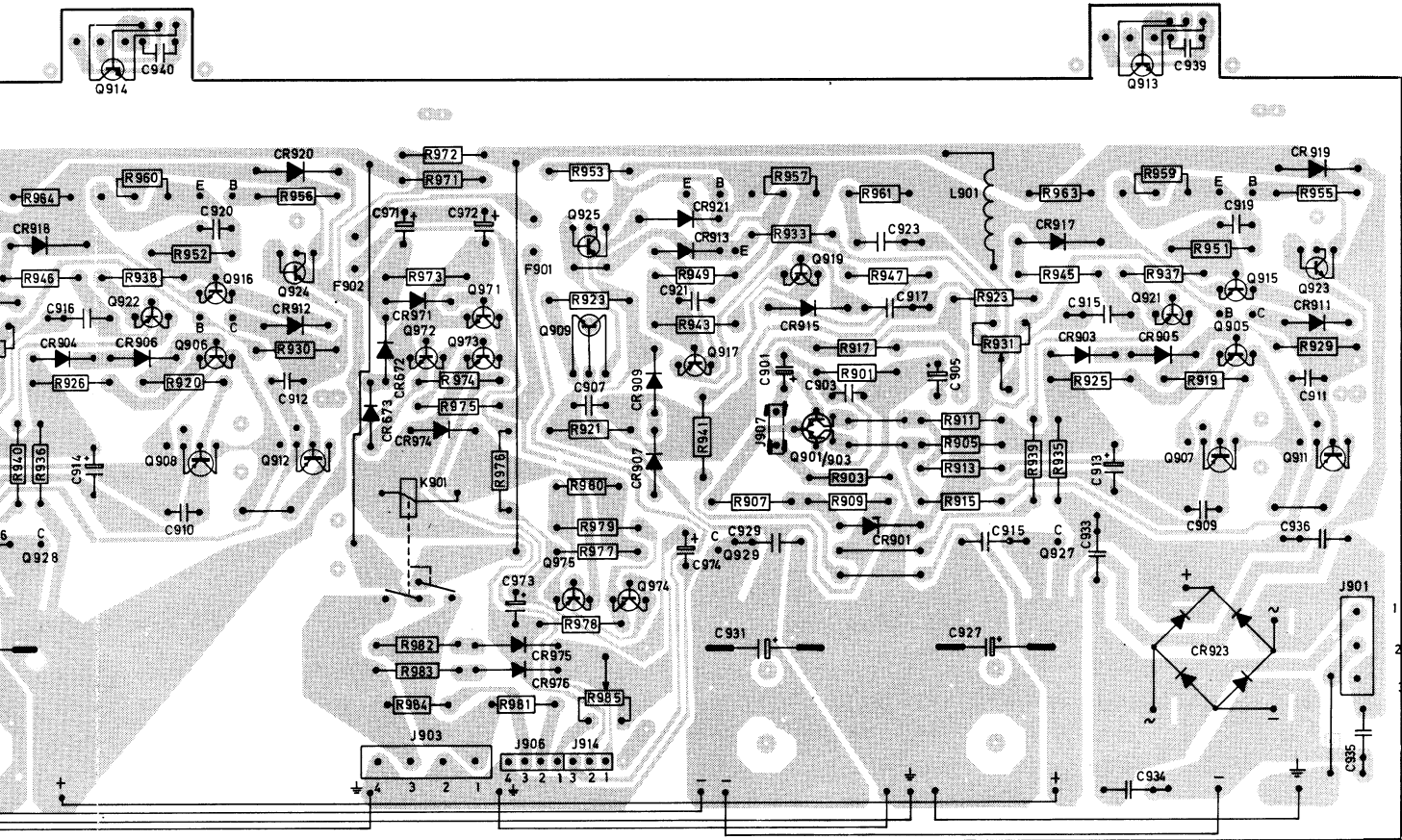

PW-BBOARD, POWER AMPLIFIER
TL-KORT, UTGANGSFORSTERKER

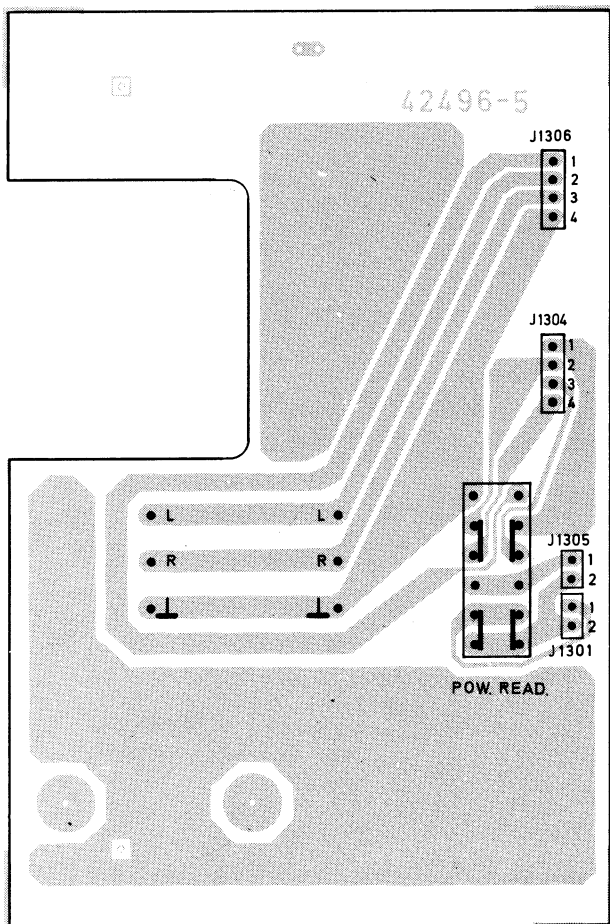

PW-BBOARD, POWER READING
TL-KORT, EFFEKTAVLESNING

*All PW-boards are seen from the solder side
Alle TL-plater er sett fra loddessiden*

DIAL/ INSTR. LAMPS BOARD

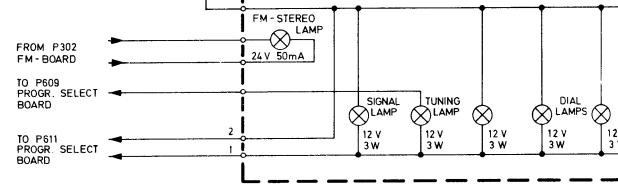

POWER-AMPLIFIER BOARD

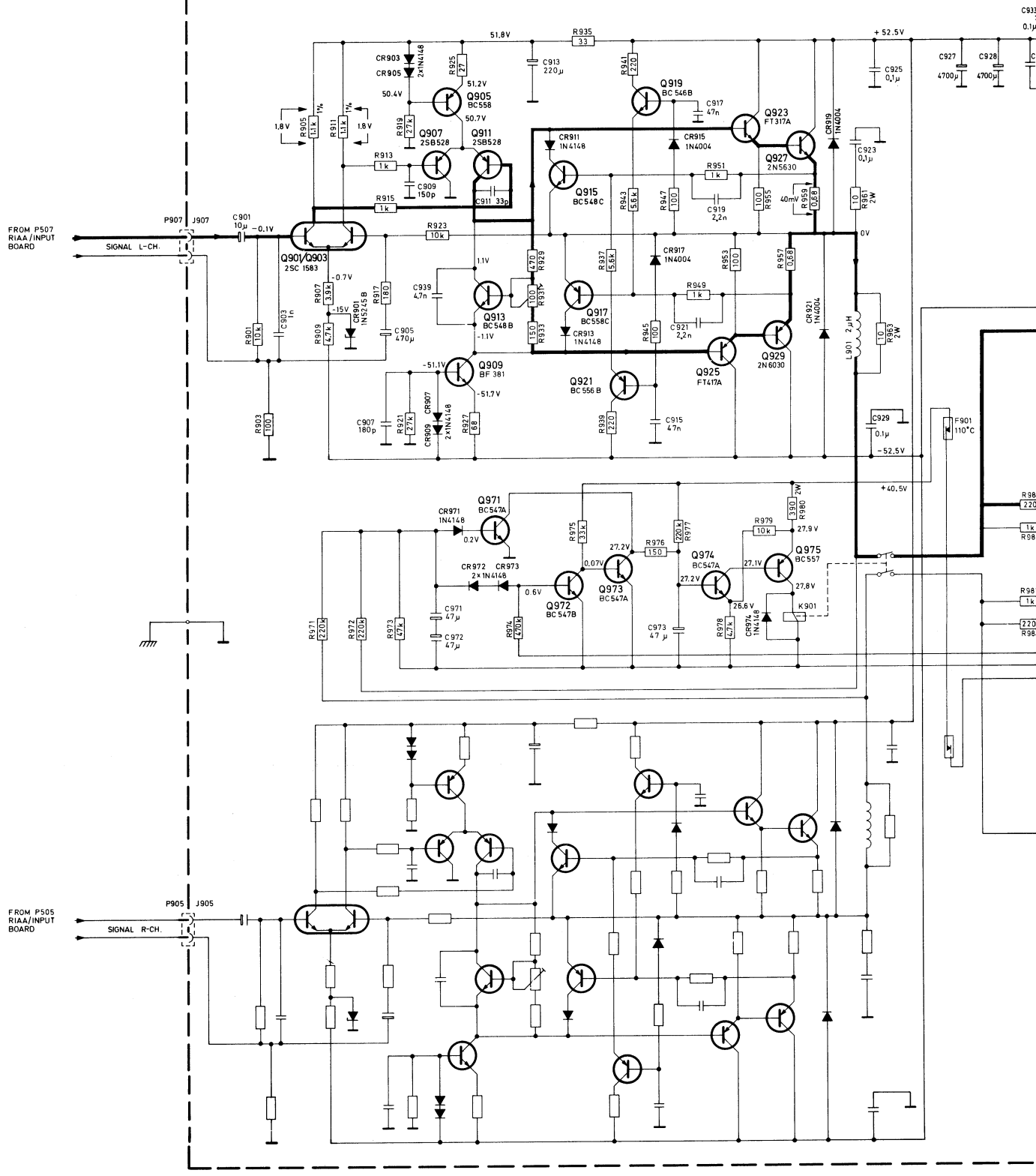

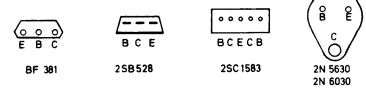
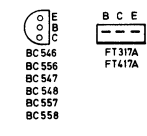
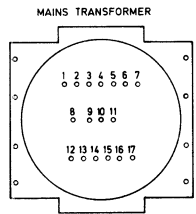
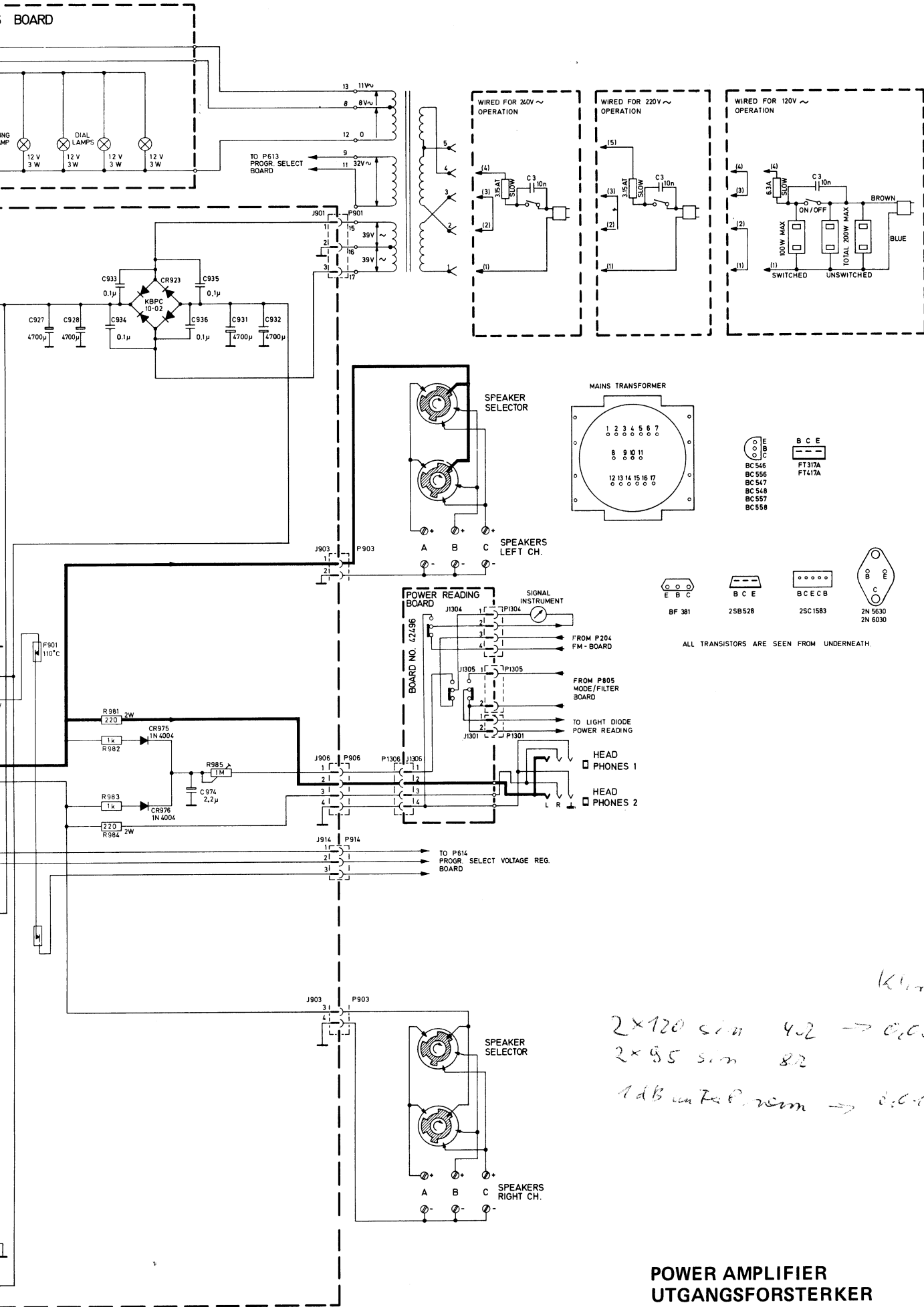

ALL TRANSISTORS ARE SEEN FROM UNDERNEATH.

KL
 2x120 sim 402 → 0,05%
 2x95 sim 82
 1dB unfiltered → 0,04%

**POWER AMPLIFIER
 UTGANGSFORSTERKER**