

## Confirmation of firmware version

Confirm the firmware version of your DR-100MKIII before conducting a firmware update.

1. Turn the unit's power ON.
2. Press the MENU button to open the MENU screen.
3. Turn the wheel to move the cursor to SYSTEM, and press the ENTER/MARK button.
4. Turn the wheel to move the cursor to INFORMATION, and press the ENTER/MARK button.
5. Turn the wheel to open the FIRMWARE page. Check the version shown here.  
If the version shown here is the same or newer than the firmware version that you planned to update to, then there is no need to update it.

## Firmware update procedures

### CAUTION

*When updating the firmware, be sure that the built-in batteries have sufficient charge or power the unit using a TASCAM PS-P520E AC adaptor (sold separately).*

*The program has been set so that the update will not be conducted if the built-in battery power is insufficient.*

1. Download the most recent firmware from the TEAC Global Site (<http://teac-global.com/>). If the file that you have downloaded is compressed in ZIP format, for example, decompress it.
2. Confirm that an SD card is loaded in the unit, turn the unit on and connect it to the computer using the a commercially-available USB cable.

### CAUTION

*Connect the unit directly to the computer without using a hub.*

3. Select the SYSTEM screen USB STORAGE item, and press the ENTER/MARK button to open a screen confirming connection with the computer.



4. Select YES, and press the ENTER/MARK button. The unit enters USB storage mode and connects with the computer.

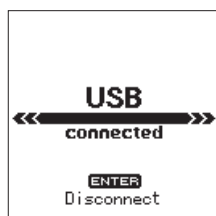

5. This unit appears on the computer as an external drive named "DR-100MKIII" (if the card was formatted by this unit). Copy the downloaded firmware to the DR-100MKIII. Copy it to the "UTILITY" folder.
6. After copying completes, use the proper procedures for the computer to unmount this unit. See the computer's operation manual for instructions about how to unmount an external volume.  
After pressing the ENTER/MARK button to reopen the Home Screen, turn the unit off.
7. While pressing and holding both the ENTER/MARK and I◀◀ buttons, turn the unit power ON. The unit starts up in update mode, and the update file appears on the screen.

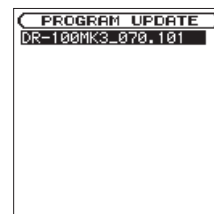

### CAUTION

- If this screen does not appear, turn the power OFF. Then while pressing and holding both the ENTER/MARK and I◀◀ buttons, turn the unit's power ON again. Continue to press and hold the ENTER/MARK and I◀◀ buttons firmly until this screen appears.
- When firmware has been copied to this unit's "UTILITY" folder from a Mac, in addition to the firmware file itself, another file with "\_" added to the beginning of the firmware name is also shown. Use the file without the "\_" at the beginning of the name.

### NOTE

- This screen shows a list of the firmware update files inside the "UTILITY" folder of the unit. Also, the screen shows the firmware copied at Step 3 above. No update file appears if there is no update file in the "UTILITY" folder.
- The screen shown is an example. The actual display differs.

- Turn the wheel to select the firmware, and press the ENTER/MARK button. The screen shown below will appear.

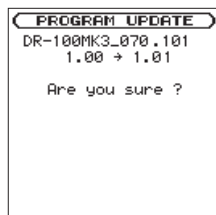

The current version appears on the left and the updated version appears on the right.

**NOTE**

*The screen shown is an example. The actual display differs.*

- Press the ENTER/MARK button to start the update. (Press the STOP [■] button to cancel the update.)
- When the update is complete, **F/W update Complete** appears at the bottom of the screen, and then the power turns OFF automatically. Turn the power ON again.
- Follow the “Confirmation of firmware version” instructions above to check that the **VERSION** is now the most recent version of the firmware. This completes the procedure for updating this unit.
- Connect to a computer with USB and delete the firmware update from the unit’s **UTILITY** folder.

# TASCAM

D01303820A

# DR-100mkIII

## Linear PCM Recorder

### Reference Manual

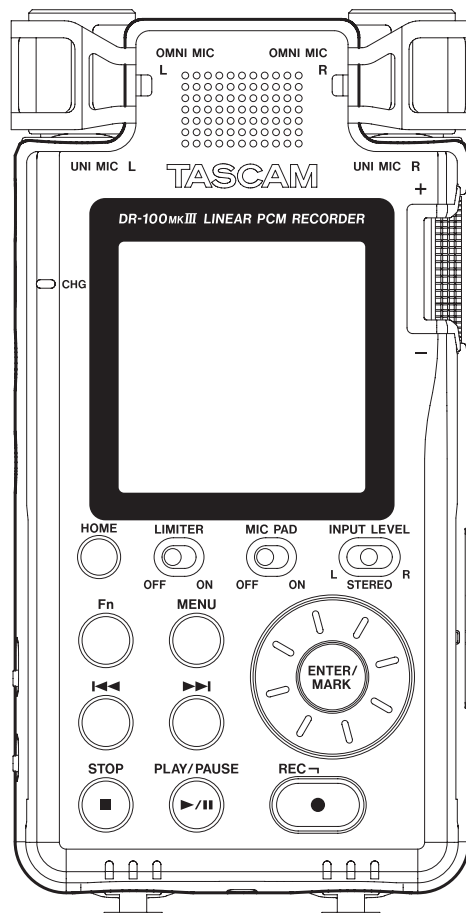

# Contents

<b>1 – Introduction .....</b>	<b>4</b>
Features .....	4
Conventions used in this manual .....	4
Recycling lithium-ion rechargeable batteries .....	4
Trademarks and copyrights.....	4
About SD cards .....	5
Precautions for use .....	5
<b>2 – Names and functions of parts .....</b>	<b>6</b>
Top.....	6
Front.....	7
Rear .....	7
Left side .....	7
Right side .....	8
Bottom.....	8
Home Screen .....	8
Basic menu operation procedures.....	10
Menu list.....	12
Function menu list.....	13
<b>3 – Preparation.....</b>	<b>14</b>
Powering the unit .....	14
Using the built-in battery .....	14
Using AA batteries .....	14
Using an AC adapter (sold separately) .....	15
Using an external battery pack (sold separately) .....	15
Inserting and removing SD cards.....	15
Inserting the card.....	15
Removing the card .....	15
SD card write protection switches .....	15
HOLD function for preventing accidental operation..	16
Turning the power on and off (putting it in standby)..	16
Turning the unit on.....	16
Turning the unit off (putting it in standby).....	16
Resume function .....	16
Selecting the language.....	16
If you accidentally select the wrong language.....	16
Setting the date and time .....	17
Preparing an SD card for use .....	17
Preparing the recording inputs .....	17
Recording with the built-in mics .....	17
Recording with connected mics.....	17
Recording external devices .....	18
Recording from digital devices .....	18
Using the built-in speaker for playback .....	19
Connecting monitoring equipment .....	19
Adjusting playback volume.....	19
Connecting cameras.....	19
<b>4 – Recording .....</b>	<b>20</b>
Recording.....	20
Remaining recording time display.....	20
Listening while recording (monitoring).....	20
Setting where to save files.....	21
Setting the file format and sampling frequency...21	

Recording in mono (file type setting) .....	21
Setting recording input sources.....	21
Setting power used by mics.....	22
Using phantom power .....	22
Using plug-in power .....	22
Setting the low-cut filter .....	23
Using the limiter .....	23
Using the Level Control Function.....	23
Using mid-side microphones .....	24
Setting the characteristics of the digital filter (A/D)...24	
Improving recording signal-to-noise (Dual ADC function)..25	
Starting recording automatically (AUTO REC function) ..25	
Recording in LEVEL mode.....	25
Recording in DIGITAL mode .....	26
Capturing the moment before recording starts (PRE REC function).....	26
Create a new file while continuing to record (file incrementing function) .....	26
Create a new file manually while recording .....	26
Creating new files automatically at a set time interval ... 27	
Recording two files simultaneously (DUAL REC function) ..27	
Recording at two different levels (dual level recording) .. 27	
Recording with two different formats (dual format recording) .. 27	
Names of backup files when using dual recording.....	28
Using the auto tone function .....	28
Turning XRI data recording on/off .....	28
Recording times .....	29

## **5 – Playback.....30**

Playing recordings.....	30
Pausing playback.....	30
Stopping playback.....	30
Searching backward and forward .....	30
Changing the playback position .....	30
Selecting files for playback (skipping).....	30
Repeat playback (LOOP PLAY).....	30
Changing the speed of playback (VSA playback)..31	

## **6 – Working with Files and Folders.....32**

Opening the Browse Screen .....	32
Icons on the Browse Screen .....	32
Basic Browse Screen operations.....	32
File operations .....	32
Folder operations.....	33
Creating new folders .....	34
Protecting files.....	34
Deleting files.....	34
Dividing files.....	34
Dividing files manually (DIVIDE function).....	34
Dividing files at marks (MARK DIVIDE function).....	35
Setting the file name format .....	36
Setting the WORD item.....	36
Resetting file numbers.....	37

<b>7 – Mark functions .....</b>	<b>38</b>
Mark types .....	38
Adding marks .....	38
Adding marks manually .....	38
Adding marks automatically .....	38
Adding marks at peak levels .....	39
Moving between marks (mark skipping) .....	39
Deleting marks .....	39
<b>8 – Settings and Information .....</b>	<b>40</b>
Making power and display settings .....	40
Setting the automatic power saving function .....	40
Set the priority battery type .....	40
Setting the AA battery type .....	40
Setting the backlight .....	40
Setting the backlight brightness .....	40
Adjusting the display contrast .....	40
Turning indicators off .....	40
Setting the peak level function .....	41
Viewing information .....	41
File information page .....	41
Card information page .....	42
Firmware version page .....	42
XRI date the information page .....	42
Restoring factory default settings .....	43
Formatting SD cards .....	43
Power-on recording function .....	44
Attenuating the output .....	44
Restricting the line output level .....	44
Restricting the headphone output level .....	44
<b>9 – Connecting with a Computer .....</b>	<b>45</b>
Transferring files to a computer .....	45
Transferring files from a computer .....	45
Disconnecting from a computer .....	45
<b>10 – Using the REMOTE jack .....</b>	<b>46</b>
Using a remote control (TASCAM RC-10) .....	46
Setting up a remote control .....	46
Using the remote control .....	46
Using a footswitch (TASCAM RC-3F) .....	46
Setting up the footswitch .....	46
Using the footswitch .....	46
<b>11 – Messages .....</b>	<b>47</b>
<b>12 – Troubleshooting .....</b>	<b>49</b>
<b>13 – Specifications .....</b>	<b>50</b>
Ratings .....	50
Input/output ratings .....	50
Analog audio input and output ratings .....	50
Digital input .....	50
Control input/output ratings .....	50
Audio performance .....	50
General .....	51
Dimensional drawings .....	51

# 1 – Introduction

## Features

- Linear PCM recorder that supports 192kHz/24-bit resolution
- Uses SD/SDHC/SDXC cards as recording media
- Two types of stereo microphones—directional and omnidirectional—allow high-quality stereo recording
- Various input jacks support diverse applications
- XLR/TRS combo jacks that support +4dBu line level and +48V phantom power enable the connection of external mics and devices
- 20dB headroom for both mic and line inputs
- Dual ADC function improves signal-to-noise performance using two AD converters
- Power-on recording function can start recording immediately after starting up.
- Dual level recording function allows two files to be recorded at different levels
- Dual format recording function allows recording with two different formats
- Continuous operation for extended times is possible by using the built-in battery and AA batteries together

## Conventions used in this manual

The following conventions are used in this manual.

- When we refer to buttons, connectors and other parts of this unit and other equipment, we use a bold font like this: **MENU** button.
- When we show messages, for example, that appear on the unit's display, the typeface looks like this: `MENU`.
- SD memory cards are called "SD cards".
- Words that appear on the computer display are shown in quotation marks like this: "DR-100MK3".

## Recycling lithium-ion rechargeable batteries

This unit uses a built-in rechargeable lithium-ion battery.

When you no longer need a battery, take it to a shop that participates in rechargeable battery recycling rather than throwing it away in order to preserve precious resources.

If you are uncertain, please contact TASCAM customer support (see back cover).



## Trademarks and copyrights

- TASCAM is a trademark of TEAC CORPORATION, registered in the U.S. and other countries.
- SDXC Logo is a trademark of SD-3C, LLC.



- MPEG Layer-3 audio coding technology licensed from Fraunhofer IIS and Thomson.
- Supply of this product does not convey a license nor imply any right to distribute MPEG Layer-3 compliant content created with this product in revenue-generating broadcast systems (terrestrial, satellite, cable and/or other distribution channels), streaming applications (via Internet, intranets and/or other networks), other content distribution systems (pay-audio or audio-on-demand applications and the like) or on physical media (compact discs, digital versatile discs, semiconductor chips, hard drives, memory cards and the like). An independent license for such use is required. For details, please visit <http://mp3licensing.com>.
- Blackfin® and the Blackfin logo are registered trademarks of Analog Devices, Inc.
- Other company names, product names and logos in this document are the trademarks or registered trademarks of their respective owners.

Information is given about products in this manual only for the purpose of example and does not indicate any guarantees against infringements of third-party intellectual property rights and other rights related to them. TEAC Corporation will bear no responsibility for infringements on third-party intellectual property rights or other liabilities that occur as a result of the use of this product.

Properties copyrighted by third parties cannot be used for any purpose other than personal enjoyment and the like without the permission of the right holders recognized by copyright law. Always use this equipment properly. TEAC Corporation will bear no responsibility for rights infringements committed by users of this product.

---

## About SD cards

---

This unit uses SD cards for recording and playback.

It can use 64MB–2GB SD cards, 4–32GB SDHC cards and 48–128GB SDXC cards.

A list of SD cards that have been confirmed for use with this unit can be found on the TASCAM website (<http://tascam.com/>). You can also contact TASCAM customer support for information.

---

## Precautions for use

SD cards are delicate media. In order to avoid damaging SD cards, please take the following precautions when handling them.

- Do not leave them in extremely hot or cold places.
- Do not leave them in extremely humid places.
- Do not let them get wet.
- Do not put things on top of them or twist them.
- Do not hit them.
- Do not remove or insert them during recording, playback, data transmission or other access.
- When transporting them, put them into cases, for example.

# 2 – Names and functions of parts

## Top

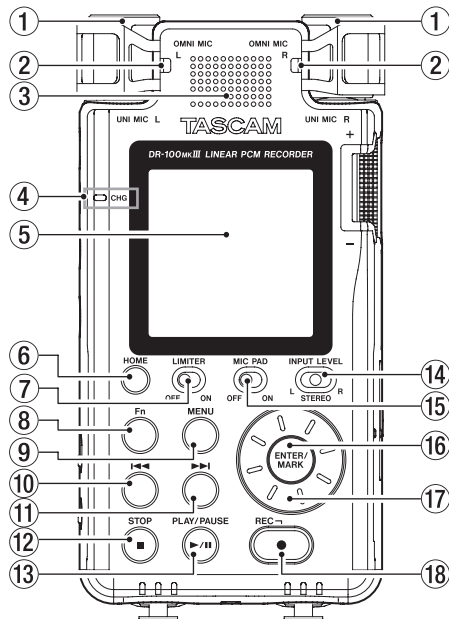

- ① **UNI MIC L/R (built-in directional stereo mic)**  
This built-in mic is a stereo electret condenser microphone.
- ② **OMNI MIC L/R (built-in omnidirectional stereo mic)**  
This built-in mic is a stereo electret condenser microphone.
- ③ **Built-in speaker (mono)**  
Use this built-in speaker to listen to recordings.  
Sound will not be output from the speaker in the following conditions.
  - The (speaker) switch is set to **OFF**
  - Recording/recording standby
  - When headphones are connected
- ④ **CHG (charge) indicator**  
This lights orange when the built-in battery is charging and becomes green when charging completes. (See “Using the built-in battery” on page 14.)
- ⑤ **Display**  
Shows a variety of information.
- ⑥ **HOME button**  
When any other screen is open, press this button to return to the Home Screen.
- ⑦ **LIMITER switch**  
This enables the limiter. (See “Using the limiter” on page 23.)
- ⑧ **Fn button**  
When the Home Screen is open, press to open the **FUNCTION** screen. (See “Basic menu operation procedures” on page 10.)
- ⑨ **MENU button**  
When the Home Screen is open, press to open the **MENU** screen. (See “Basic menu operation procedures” on page 10.)  
When the **MENU** screen is open, press this button to return to the Home Screen.

- ⑩ **◀◀ button**  
When the Home Screen is open, use to skip files and search backward. Press this button while pressing and holding the **ENTER/MARK** button to move to the previous mark.  
When a menu is open, use this to move between screens and move the cursor.
- ⑪ **▶▶ button**  
When the Home Screen is open, use to skip files and search forward. Press this button while pressing and holding the **ENTER/MARK** button to move to the next mark.  
Use to create a new file manually (divide) while recording.  
When a menu is open, use this to move between screens and move the cursor.
- ⑫ **STOP [■] button**  
Press during playback to pause playback at the current position.  
Press when paused to return to the beginning of the playback file.  
Press when recording or in recording standby to stop recording.  
Press and hold the (power) button for at least 10 seconds while pressing this button to force the unit to turn off (enter standby).
- ⑬ **PLAY/PAUSE [▶/||] button**  
When the Home Screen is open and the unit is stopped, press this button to start playback.  
Press when playing to pause playback.  
When a file is selected on the Browse Screen, press this to return to the Home Screen and play that file from the beginning.
- ⑭ **INPUT LEVEL switch**  
Select which inputs are affected by operation of the input level knob.
- ⑮ **MIC PAD switch**  
Use to change input sensitivity.
- ⑯ **ENTER/MARK button**  
When using a menu setting screen, press to confirm the selected item.  
Press to add marks manually when recording or playing back.  
Press the ◀◀ or ▶▶ button while pressing and holding this button to move to the previous or next mark, respectively. (See “Moving between marks (mark skipping)” on page 39.)
- ⑰ **Wheel**  
Use to select items and change values on setting screens.  
Use also to change the file playback position.
- ⑱ **REC [●] button/REC indicator**  
When stopped, press this button to put the unit into recording standby. The **REC** indicator will start to blink.  
Press when recording to start recording standby.

## 2 – Names and functions of parts

### Front

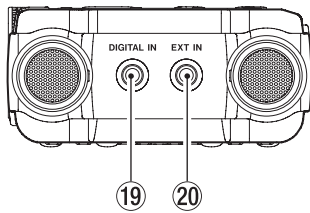

- ①9 **DIGITAL IN connector**  
Connect the included digital input conversion cable to input digital signals into this unit. (See “Recording from digital devices” on page 18.)
- ②0 **EXT IN connector**  
Use a stereo mini jack cable to connect with the line output jack of an audio device, for example.

### Rear

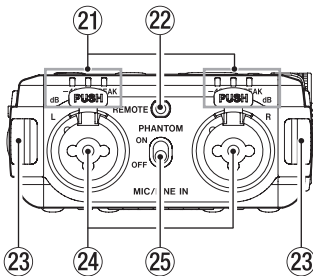

- ②1 **Level indicators**  
The **-48 (dB)**, **-6 (dB)** or **PEAK** indicators light according to the input levels.
- ②2 **REMOTE jack**  
Connect a TASCAM RC-3F footswitch or TASCAM RC-10 wired remote control (both sold separately) here. This enables remote starting and stopping of playback and other functions. (See “9 – Connecting with a Computer” on page 45.)
- ②3 **Strap attachments**
- ②4 **MIC/LINE IN L/R jacks (XLR/TRS)**  
These balanced analog jacks are XLR mic and standard TRS inputs.  
XLR (1: GND, 2: HOT, 3: COLD)  
TRS (Tip: HOT, Ring: COLD, Sleeve: GND)
- ②5 **PHANTOM switch**  
Set whether phantom power is on or off for the **MIC/LINE IN** jacks. (See “Using phantom power” on page 22.)

### Left side

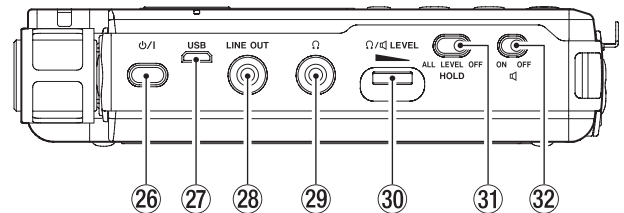

- ②6 **⏻ (power) button**  
Press and hold this button to turn the unit on and to put it into standby (off).  
  
Press and hold this button for at least 10 seconds while pressing the **STOP [■]** button to force the unit to turn off (enter standby).

#### CAUTION

*Before turning the unit on, lower the volumes of connected equipment to their minimum levels.*

*Failure to do so might cause sudden loud noises, which could harm your hearing or result in other trouble.*

- ②7 **USB port**  
This is a Micro-B USB port.  
Use a USB cable (A to Micro-B) to connect the unit to a computer. (See “9 – Connecting with a Computer” on page 45.)  
  
The USB port can supply power to the unit. (See “Powering the unit” on page 14.)

#### CAUTION

*The unit should be connected directly to the computer, not through a USB hub.*

- ②8 **LINE OUT jack**  
Use this to connect with the line input jack of an amp or other equipment.
- ②9 **Ω (headphone) jack**  
Use this jack to connect headphones. (See “Connecting monitoring equipment” on page 19.)
- ③0 **Ω/🔊(headphone/speaker) LEVEL volume**  
Use to adjust the volume output from the built-in speaker and Ω (headphones).
- ③1 **HOLD switch**  
Slide this switch to **ALL** or **LEVEL** to enable the hold function that can prevent accidental operation. (See “HOLD function for preventing accidental operation” on page 16.)
- ③2 **🔊 (speaker) switch**  
When set to **ON**, sound will be output from the built-in speaker.

#### NOTE

*Even when set to ON, sound will not be output when the unit is recording, in recording standby or has headphones connected.*

## 2 – Names and functions of parts

### Right side

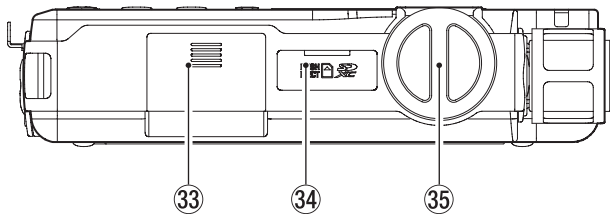

- ③③ **Battery compartment (AA batteries)**  
Install batteries (2 AA) in this compartment to power the unit. (See “Using AA batteries” on page 14.)
- ③④ **SD card slot**  
Insert an SD card here.
- ③⑤ **Input level knob**  
Use this to adjust the input signal volume.

### Bottom

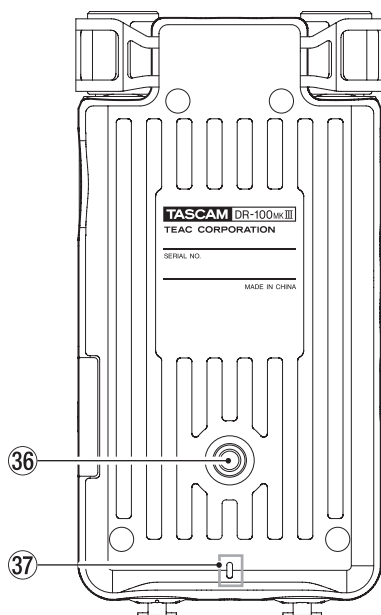

- ③⑥ **Tripod mounting threads (1/4-inch)**  
Use to attach this unit to a tripod.

#### CAUTION

- *Securely tighten all the screws on the tripod or microphone stand to prevent the unit from falling off.*
- *When using this unit attached to a tripod or microphone stand, place it on a level surface.*
- *Some tripods have different screw specifications that make direct connection impossible. Use a commercially-available adapter with such tripods.*
- *Screws longer than 4.5 mm cannot be attached.*

- ③⑦ **REC indicator**  
This functions in the same way as the **REC** indicator on the top of the unit.

### Home Screen

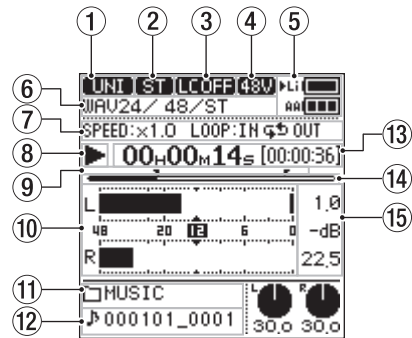

Stopped/playing

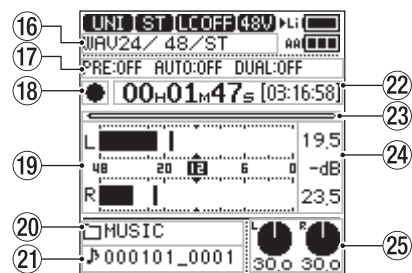



Recording/recording standby

- ① **Input source**  
This shows the input source set with the I/O SETTING screen SOURCE item. (See “Setting recording input sources” on page 21.)
- |              |  |
|--------------|--|
| <b>UNI</b>   | <b>UNI MIC</b> (built-in directional mic) input      |
| <b>OMNI</b>  | <b>OMNI MIC</b> (built-in omnidirectional mic) input |
| <b>MIC</b>   | <b>MIC/LINE IN</b> jack connected mic input          |
| <b>LINE</b>  | <b>MIC/LINE IN</b> jack connected line level input   |
| <b>EXT M</b> | <b>EXT IN</b> jack connected mic input               |
| <b>EXT L</b> | <b>EXT IN</b> jack connected line level input        |
| <b>D-IN</b>  | <b>DIGITAL IN</b> jack connected digital input       |
- ② **Input channel indicator (ST/L/R/MIX)**  
This shows the REC SETTING screen FILE TYPE item setting. (See “Recording in mono (file type setting)” on page 21.)
- |            |                               |
|------------|-------------------------------|
| <b>ST</b>  | Stereo input/stereo file      |
| <b>L</b>   | Left channel input/mono file  |
| <b>R</b>   | Right channel input/mono file |
| <b>MIX</b> | L-R mix input/mono file       |
- ③ **Low cut filter on/off status**  
This icon shows whether the low cut filter is on or off. (See “Setting the low-cut filter” on page 23.)
- |               |                            |
|---------------|----------------------------|
| <b>LCOFF</b>  | Low cut filter off         |
| <b>LC 40</b>  | Low cut filter on (40 Hz)  |
| <b>LC 80</b>  | Low cut filter on (80 Hz)  |
| <b>LC 120</b> | Low cut filter on (120 Hz) |
| <b>LC 220</b> | Low cut filter on (220 Hz) |

## 2 – Names and functions of parts

### ④ Phantom power supply status

When the **PHANTOM** switch is set to **ON**, this icon shows the phantom power supply voltage. (See “Setting the phantom power voltage” on page 22.)

- No icon Phantom power off
-  Phantom power on with +48V supplied
-  Phantom power on with +24V supplied

### ⑤ Power supply status

When powered by batteries, a ► appears next to the icon for the type of battery being used. (See “Set the priority battery type” on page 40.)

The amount of battery power remaining is shown in the battery icons with 14 levels for the built-in battery and 3 levels for the AA batteries.

- Built-in battery 
- AA batteries 

When the battery type being used runs out of power, its icon blinks and the ► moves to the icon for the other type of battery.

If both types of batteries run out power, their icons blink, indicating that the unit will soon turn off (enter standby).

### ⑥ File format

This shows the format, sampling frequency and number of channels of the playing file.

### ⑦ Playback speed/loop playback status

This shows the setting status of the VSA and loop playback functions.

- SPEED** This shows the VSA playback function status.
- LOOP** This shows the loop playback function status.



### ⑧ Transport status (stopped/playing)

This icon shows the recorder operation status.

Indicator	Meaning
■	Stopped at the beginning of the file
	Paused
▶	Playing back
▶▶	Searching forward
◀◀	Searching backward
▶▶	Skipping to the beginning of the next file
◀◀	Skipping to the beginning of the current or previous file

### ⑨ Loop playback IN (starting) and OUT (ending) points

When the loop playback function is on, these show the loop IN (starting) and OUT (ending) points.

-  IN (starting) point
-  OUT (ending) point

### ⑩ Level meters

These show the maximum (peak) playback levels.

### ⑪ Playback folder name

This shows the name of the folder that contains the file playing back.

### ⑫ Playback file name

The file name or tag information of the file currently being played back is shown.

When ID3 tag information is available for an MP3 file being played, it is given priority for display.

If a file is protected, a  mark appears before the file name. (See “Protecting files” on page 34.)

### NOTE

*ID3 tag information includes the titles and artists names that can be saved in MP3 files.*

### ⑬ Playback time/remaining playback time

Shows the elapsed time and remaining playback time (hours: minutes: seconds) of the playing file.

### ⑭ Playback position

The current playback position is shown by a bar. As playback progresses, the bar extends from the left.

### ⑮ Peak value in decibels (dB)

These show the maximum (peak) playback levels in decibels.

### ⑯ Recording format

This shows the format, sampling frequency and number of channels of the file being recorded.

### ⑰ Recording function information

This shows the settings of the dual, pre and automatic recording functions.

- DUAL** This shows the dual recording function status.
- PRE** This shows the prerecording function status.
- AUTO** This shows the automatic recording function status.

### ⑱ Transport status (recording standby/recording)

This icon shows the recorder operation status.

Indicator	Meaning
●	Recording standby
●	Recording

### ⑲ Level meters

These show the input signal levels.

### ⑳ Recording folder name

This shows the name of the folder where the recording file will be saved.

### ㉑ Recording file name

The file name that will automatically be given to the recorded file is shown.

### ㉒ Recording time/remaining recording time

This shows the elapsed time (hours: minutes: seconds) of the file being recorded and the remaining available time (hours: minutes: seconds) on the SD card using the set input source, file format and sampling frequency.

### ㉓ Recording position

This bar shows the remaining available time (hours: minutes: seconds) on the SD card using the set input source, file format and sampling frequency.

As recording progresses, the bar extends from the left.

### ㉔ Peak input level in decibels (dB)

Peak input level values are shown in decibels.

When the input level exceeds the peak level, the  icon appears.

## 2 – Names and functions of parts

### 25 Input levels

These show the input level setting values.

### Basic menu operation procedures

The operation procedures for both the **MENU** and **FUNCTION** screens are basically the same.

Here we explain **MENU** screen operations using dual recording settings as an example.

#### 1. Open the **MENU** screen.

When the Home Screen is open, press the **MENU** button to open the **MENU** screen.

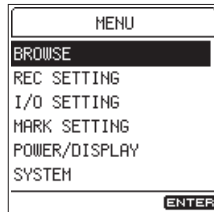

- Press the **HOME** button to return to the Home Screen.

#### 2. Open the **REC SETTING** screen.

Turn the wheel to move the cursor to the menu item you want to change (**REC SETTING** in this case), and press the **ENTER/MARK** button.



The **REC SETTING** screen opens.

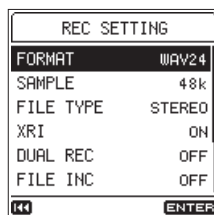

- Press the **◀** button to return to the previous screen.
- Press the **HOME** button to return to the Home Screen.

#### 3. Open the **DUAL REC** screen.

Turn the wheel to move the cursor to the item you want to change (**DUAL REC** in this case), and press the **ENTER/MARK** button.

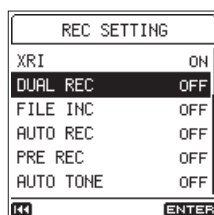

The **DUAL REC** screen opens.

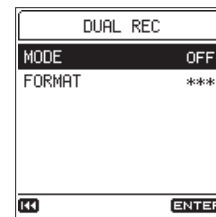

- Setting values that cannot be changed because of the operation mode, for example, are shown as \*\*\*.
- Press the **◀** button to return to the previous screen.
- Press the **HOME** button to return to the Home Screen.

#### 4. Change the setting.

Turn the wheel to move the cursor to the item you want to change (**MODE** in this case), and press the **ENTER/MARK** button.

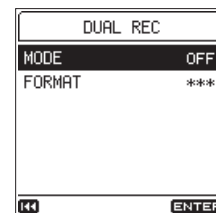

The setting selection screen opens.

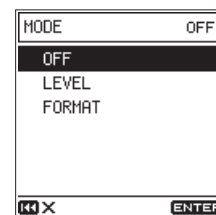

- This current setting is shown at the top right. Just moving the cursor does not change the setting.
- Before pressing the **ENTER/MARK** button to confirm the change, press the **.** button to cancel the change and return to the previous screen.
- Press the **HOME** button to cancel the change and return to the Home Screen.
- Press the **MENU** button to cancel the change and return to the **MENU** screen.
- Press the **ENTER/MARK** button to confirm the change and return to the previous screen.

## 2 – Names and functions of parts

Turn the wheel to move the cursor to **FORMAT**, and press the **ENTER/MARK** button.

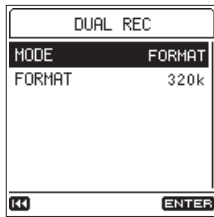

You can change **FORMAT** item settings in a similar manner. When finished, press the **HOME** button to return to the Home Screen.

### NOTE

- The **MENU** screen cannot be opened when recording or in recording standby.
- The items that appear on the **FUNCTION** screen differ according to whether the unit status is stopped/playing or recording/recording standby).

### Switching ON/OFF settings

If a setting is ON/OFF, it has no setting selection screen, and you can change it quickly.

Example: Changing the **PRE REC** setting

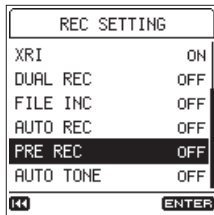

Press the **ENTER/MARK** button.

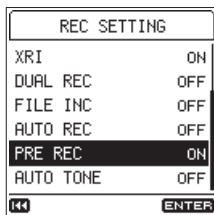

The setting is changed.

The setting changes each time you press the **ENTER/MARK** button.

### Changing settings and executing functions that require confirmation

Depending on the content of the setting, a message screen requiring confirmation of the change might appear.

Example: Executing quick formatting.

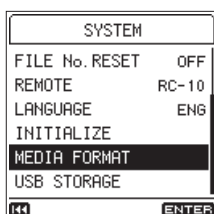

Press the **ENTER/MARK** button to open the confirmation screen.

When a confirmation screen appears, the cursor always starts on **NO**.

Press the **ENTER/MARK** button when the cursor is on **NO** to cancel execution and return to the previous screen.



Turn the wheel to move the cursor to **YES** and press the **ENTER/MARK** button to execute the function and return to the previous screen.

- Press the **HOME** button to cancel execution and return to the Home Screen.
- Press the **MENU** button to cancel execution and return to the **MENU** screen.

## 2 – Names and functions of parts

### Menu list

Press the **MENU** button to open the MENU screen.

The menu items are as follows.

Menu item	Function	Page	
BROWSE	Work with files and folders on the SD card	see page 32	
REC SETTING	FORMAT	Set the recording file format	see page 21
	SAMPLE	Setting the sampling frequency	see page 21
	FILE TYPE	Set the file type	see page 21
	XRI	Turn XRI data recording on/off	see page 28
	DUAL REC	Set dual recording function	see page 27
	FILE INC	Set the recording time interval for automatically dividing (creating new) files	see page 27
	AUTO REC	Set the auto-recording function	see page 25
	PRE REC	Set the pre-recording function	see page 26
	AUTO TONE	Set the auto tone function	see page 28
I/O SETTING	SOURCE	Set the input source	see page 21
	A/D FILTER	Set the A/D converter filter	see page 24
	DUAL ADC	Turn on/off this function that improves S/N performance	see page 25
	LOW CUT	Set the low-cut filter	see page 23
	LEVEL CONTROL	Set the level control function	see page 23
	HS DECODE	Set the mid-side decoding function	see page 24
	PHANTOM VOLT	Set the phantom power voltage	see page 22
	PLUG IN POWER	Turn plug-in power on/off	see page 22
	OUTPUT ATT	Set the output attenuator function	see page 44
MARK SETTING	AUTO MARK	Set the automatic mark function	see page 38
	PEAK MARK	Turn the peak mark function on/off	see page 39
	MARK SKIP	Set the mark skip mode	see page 39
POWER/DISPLAY	AUTO PWR SAVE	Set the automatic power saving function	see page 40
	BATTERY	Makes settings related to the built-in and replaceable batteries	see page 40
	BACKLIGHT	Set the time the backlight stays lit	see page 40
	BRIGHTNESS	Set the backlight brightness	see page 40
	CONTRAST	Adjust the contrast	see page 40
	INDICATORS	Turn indicators on/off	see page 40
	PEAK LEVEL	Set the level meter peak hold function	see page 41
SYSTEM	INFORMATION	Shows a variety of information.	see page 41
	DATE/TIME	Set the date and time	see page 17
	FILE NAME	Set the file name format.	see page 36
	FILE No. RESET	Reset the file number.	see page 37
	REMOTE	Make connected remote control settings	see page 46
	LANGUAGE	Set the language shown on the display	see page 16
	INITIALIZE	Restore factory default settings	see page 43
	MEDIA FORMAT	Format the SD card	see page 43
	USB STORAGE	Switch to USB mass storage device mode	see page 45

### CAUTION

- When recording or in recording standby, the MENU screen will not open.
- The settings for all menu items are retained even when the unit is turned off (in standby).

## 2 – Names and functions of parts

### Function menu list

The Function menu includes functions that are used on the selected playback file or the recording file.

- When the Home Screen is open, press the **Fn** button to open the **FUNCTION** Screen.

The functions shown depend on the state of the unit when the **Fn** button is pressed.

Menu item	Function	Page	
Stopped, paused or playing back	CHANGE PROTECT	Change the protection of the file selected on the Home Screen	see page 34
	FILE DELETE	Delete the file selected on the Home Screen	see page 34
	DIVIDE	Divide the file selected on the Home Screen	see page 34
	LOOP PLAY	Make loop playback settings	see page 30
	VSA PLAY	Make VSA playback settings	see page 31
	MS DECODE	Set the mid-side decoding function	see page 24
	FILE INFORMATION	Show file information for the file selected on the Home Screen	see page 41
Recording/recording standby	LOW CUT	Set the low-cut filter	see page 23
	LEVEL CONTROL	Set the level control function	see page 23
	MS DECODE	Set the mid-side decoding function	see page 24
	BATTERY	Make settings related to the built-in and replaceable batteries	see page 40

- When a folder or file is selected on the Browse Screen, press the **Fn** button to open the **FOLDER MENU** or **FILE MENU** screen.

Menu item	Function	Page	
File selected on Browse Screen	FILE INFORMATION	Show file information for the selected file	see page 32
	FILE DELETE	Delete the selected file	see page 34
	CHANGE PROTECT	Change the protection status of the selected file	see page 34
	CLR ALL MARKS	Delete all marks in the selected file	see page 33
Folder selected on Browse Screen	ALL FILES DELETE	Delete all files in the selected folder	see page 33
	FOLDER DELETE	Delete the selected folder	see page 33

# 3 – Preparation

## Powering the unit

This unit uses a built-in rechargeable lithium-ion battery. This unit can also be powered by 2 AA batteries, by using a commercially-available USB cable to supply USB bus power or by a TASCAM PS-P520E AC adapter. The USB cable can also be connected a TASCAM BP-6AA external battery pack (sold separately).

This unit can use alkaline, Ni-MH or lithium AA batteries.

## Using the built-in battery

Charge it before using the unit the first time after purchase and after it has not been used for a long time.

### ■ Charging the built-in battery

The built-in battery can be charged in the following two ways.

#### • Charging with an AC adapter

Connect a TASCAM PS-P520E AC adapter (sold separately) to the unit's **USB** port and charge the unit. (See "Using an AC adapter (sold separately)" on page 15.)

The charging time is about 4.5 hours.

#### • Charging from a connected computer

Use a USB cable (A to Micro-B) to connect a computer to the unit's **USB** port and charge the unit. (See "9 – Connecting with a Computer" on page 45.)

The charging time is about 10 hours.

### NOTE

- Always connect this unit and the computer directly. If connected through a USB hub or other device, charging might not occur properly.
- When connected by USB, the unit will charge even when it is not turned on.
- The CHG (charge) indicator will light as follows when charging.

Lit orange: charging

Lit green: charging complete

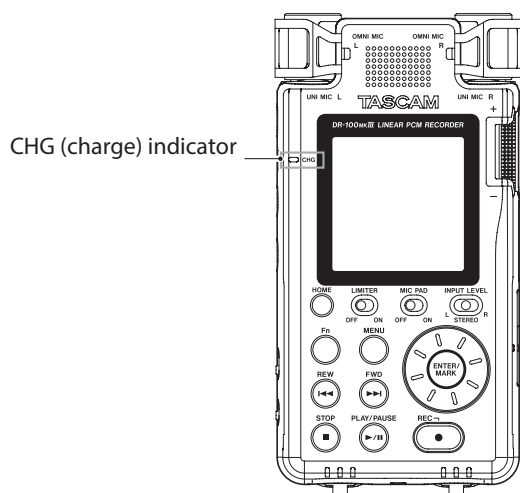

## Using AA batteries

1. Slide the battery compartment cover toward the bottom of the unit to open it.
2. Install 2 AA batteries with their ⊕ and ⊖ marks as shown in the battery compartment.
3. Close the battery compartment cover.

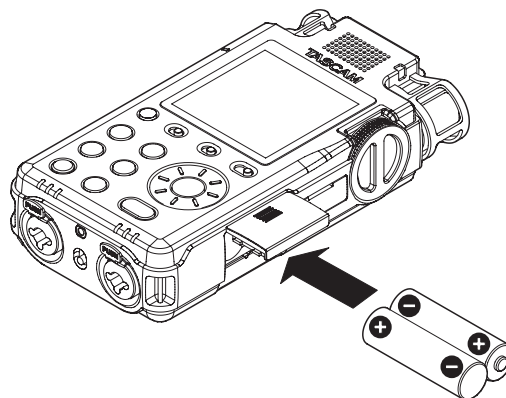

Set the type of batteries used in order to allow the unit to accurately show the amount of power remaining and determine whether enough power is available for proper operation. (By default, this is set to alkaline batteries.) (See "Setting the AA battery type" on page 40.)

### CAUTION

- Manganese dry cell batteries cannot be used with this unit.
- This unit cannot recharge Ni-MH batteries. Use a commercially available recharger.

### NOTE

A great amount of power is required to provide phantom power to a condenser microphone. If you use a condenser microphone while running the unit on AA batteries (alkaline, Ni-MH or lithium), the operation time will be shortened.

If you need to operate the unit for a long time, use a TASCAM PS-P520E AC adapter or TASCAM BP-6AA external battery pack (both sold separately) to power the unit.

### ■ Using both battery power supplies together

Continuous operation for an extended amount of time is possible by using the built-in battery and AA batteries together.

When the amount of remaining power in the priority battery source becomes insufficient, the unit automatically switches to the other battery source and continues operating. (See "Set the priority battery type" on page 40.)

The AA batteries can be changed when the built-in battery is powering the unit.

### CAUTION

Changing the AA batteries when they are powering the unit could interrupt the power causing loss of recording data and settings, for example.

Before changing the AA batteries, confirm on the Home Screen that the built-in battery has sufficient remaining power and set the battery priority to the built-in battery.

To use AA batteries as the priority battery type, after changing the batteries, set them as the priority type.

You can change the priority battery type with the POWER/ DISPLAY screen BATTERY item when stopped or playing or the FUNCTION screen BATTERY item when recording or in recording standby.

## Using an AC adapter (sold separately)

As shown in the illustration, connect a TASCAM PS-P520E AC adapter (sold separately) to the unit's **USB** port and charge the unit.



### NOTE

*When the AC adapter is connected, power will be supplied from the AC adapter. The unit can be used while it is charging.*

### CAUTION

*Noise may occur when recording with a microphone if the unit is too close to the AC adapter. In such a case, keep sufficient distance between the AC adapter and the unit.*

## Using an external battery pack (sold separately)

Connect a TASCAM BP-6AA external battery pack (designed for use with this unit and sold separately) to the recorder with a USB cable (A to Micro-B) as shown in the illustration. For details, see the BP-6AA Owner's Manual.

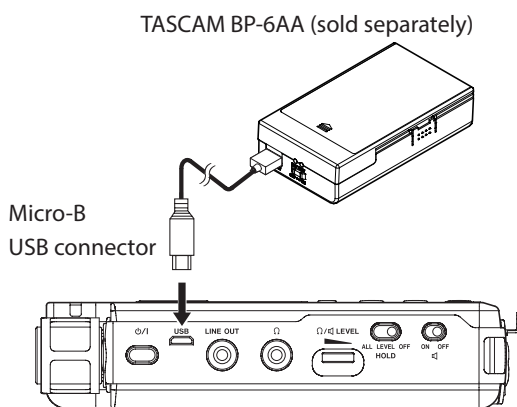

### CAUTION

*The unit cannot detect the remaining battery charge of a BP-6AA.*

## Inserting and removing SD cards

### CAUTION

- *SD cards that meet SD, SDHC or SDXC standards can be used with this unit.*
- *A list of SD cards that have been confirmed to work with this unit can be found on our website (<http://tascam.com/>).*

### Inserting the card

1. Open the SD card slot cover.
2. Insert an SD Card into the slot as shown in the illustration until it clicks into place.
3. Close the SD card slot cover.

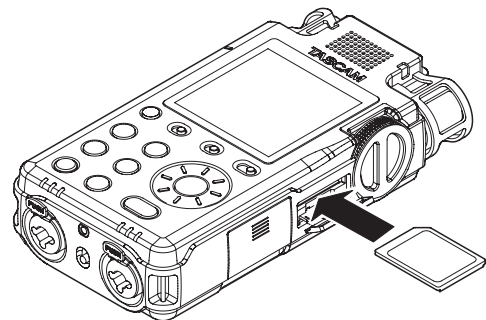

### Removing the card

1. Open the SD card slot cover.
2. Press the SD card in gently and then release it to allow it to come out.

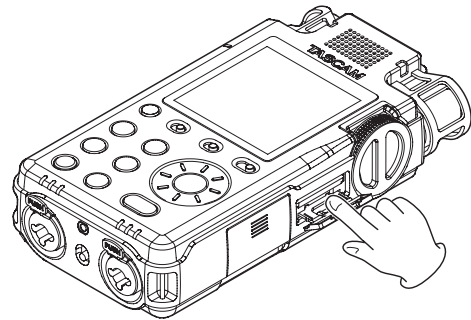

## SD card write protection switches

SD cards have protection switches that prevent writing new data to them.

If you slide the protect switch to the LOCK position, file recording and editing will not be possible. Unlock the write-protection in order to record, erase and otherwise edit data on the card.

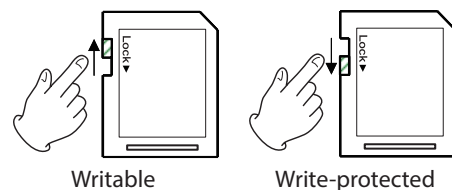

## 3 – Preparation

### HOLD function for preventing accidental operation

You can slide the **HOLD** switch to **LEVEL** or **ALL** to disable controls and prevent accidental operation.

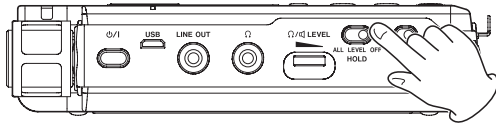

**ALL** Operations of the input level knob and all buttons are disabled

**LEVEL** Operations of the input level knob are disabled

**OFF** Hold function is off

### Turning the power on and off (putting it in standby)

#### CAUTION

- Turn down the volume of the monitoring system connected to the unit before turning the unit on/off (standby).
- Do not wear connected headphones when turning the unit on or off (putting it in standby). Noise could damage the headphone driver unit or harm your hearing.

#### Turning the unit on

When the unit is off (in standby), press and hold the  $\phi / I$  (power) button until the start-up screen appears.

The Home Screen appears after the unit starts up.



Start-up Screen

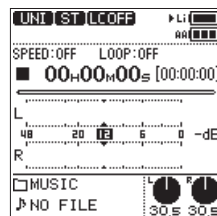

Home Screen

### Turning the unit off (putting it in standby)

When the unit is on, press and hold the  $\phi / I$  (power) button until the shutdown screen appears.

The unit turns off (enters standby) after it completes its shutdown process.

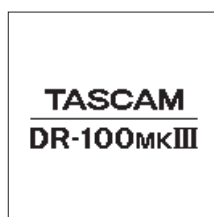

#### NOTE

You cannot turn the unit off (put it in standby) when it is recording or in recording standby.

#### CAUTION

Always use the  $\phi / I$  (power) button to turn the unit off (put it in standby).

If shutdown procedures are not conducted, recording data and settings, for example, could all be lost. Lost data and settings cannot be restored.

### Resume function

When you turn the unit off (put it in standby), it remembers the position where it was stopped.

Next time it is turned on, you can start playback from the position where it was stopped.

#### NOTE

The position where stopped is stored on the SD card. The resume function will not work if the card is changed.

### Selecting the language

You can change the language shown on the display. The first time you turn the unit on after purchasing it, the **LANGUAGE** screen will open. You can set the language used on this screen. You can also change this setting with the **SYSTEM** screen **LANGUAGE** item.



1. Turn the wheel to move the cursor and select the language.

#### Options

- ENGLISH: use English
- 日本語: use Japanese
- FRANÇAIS: use French
- ESPAÑOL: use Spanish
- DEUTSCH: use German
- ITALIANO: use Italian

2. After making the selection, press the **ENTER/MARK** button to confirm it.

### If you accidentally select the wrong language

Press the  $\phi / I$  (power) button to turn it off, and then press the  $\phi / I$  (power) button again while pressing the **MENU** button.

The language selection menu where you can set the language appears.

## Setting the date and time

You can set the unit to automatically assign file names based on the date and time of the built-in clock. (See “Setting the file name format” on page 36.)

By setting the clock in advance, the recording date and time can be added to files accurately.

The first time you turn the unit on after purchasing it and whenever the date and time has been reset, the **DATE/TIME** screen where you can set the date and time will open. You can also change this setting with the **SYSTEM** screen **DATE/TIME** item.



1. Turn the wheel to move the cursor to the item (year/month/day/hour/minute/second) you want to set, and press the **ENTER/MARK** button.
2. Turn the wheel to change the value, and press the **ENTER/MARK** button.
3. Turn the wheel to move the cursor to **OK**, and press the **ENTER/MARK** button to confirm the setting.

### NOTE

*The date and time will be reset to the default if the unit does not receive power from the built-in battery, AA batteries or an external power supply for a few minutes.*

## Preparing an SD card for use

The following message appears if an unformatted card is installed in the unit when it is turned on.



In order to use an SD card in this unit, you must format it first. Press the **ENTER/MARK** button to format the card.

### CAUTION

- *Formatting will erase all the data on the SD card. Back up to a computer, for example before formatting a card.*
- *When formatting a card, the unit should be powered by an external power supply or batteries with sufficient remaining power.*

### NOTE

*You can also use the **SYSTEM** screen **MEDIA FORMAT** item to format a card. (See “Formatting SD cards” on page 43.)*

## Preparing the recording inputs

You can select the input source from multiple options according to the application. Settings must be made according to the input source used. (See “Setting recording input sources” on page 21.)

### Recording with the built-in mics

#### ■ Using the built-in directional mics (UNI MIC) to record

This is suited for instrumental performances, bands and other live recordings as well as field recordings, for example.

Point the built-in directional mics (UNI MIC) at the sound source and place the unit in a stable location where there is little vibration.

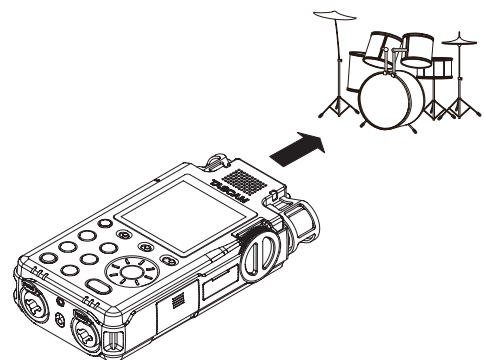

#### ■ Using the built-in omnidirectional mics (OMNI MIC) to record

This is suited for recording meetings and other situations where you want to capture all the sound in a large space. Place the unit in a stable location where there is little vibration.

### Recording with connected mics

Connect mics to the **MIC/LINE IN** XLR or TRS jacks.

Connect a stereo mic to the **EXT IN** jack.

Point the mics at the sound source and place the unit in a stable location where there is little vibration.

## 3 – Preparation

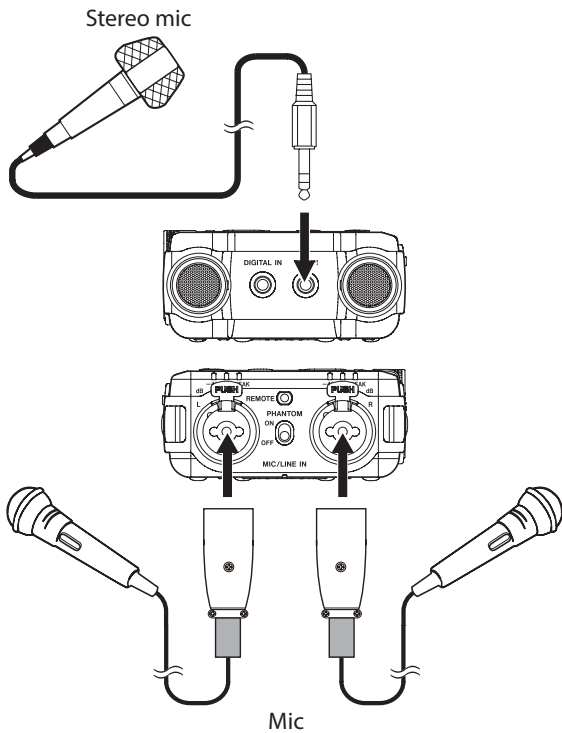

### Recording external devices

Connect external audio devices to the **MIC/LINE IN** XLR or TRS jacks.

When using a stereo mini cable, connect it to the **EXT IN** jack.

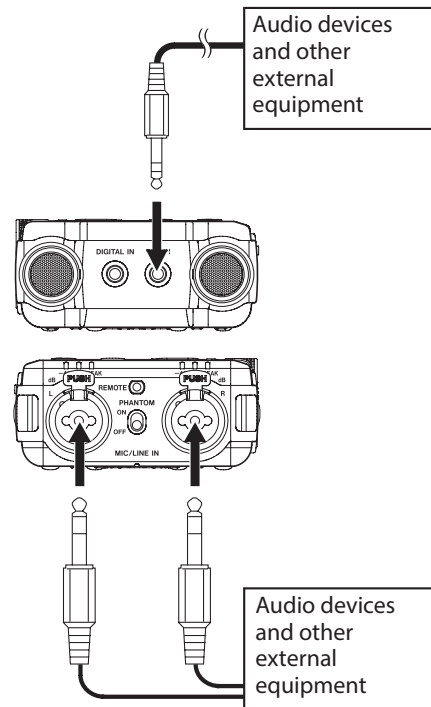

### Recording from digital devices

Use the included digital input conversion cable to connect the output of a digital audio device to the **DIGITAL IN** jack.

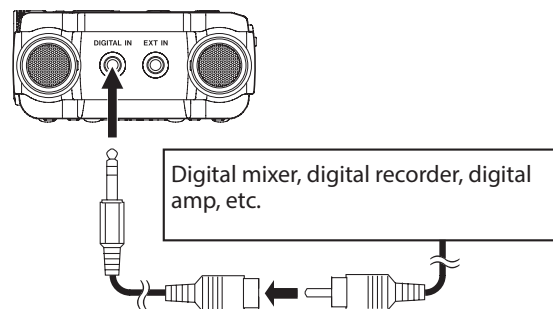

Set the I/O **SETTING** screen **SOURCE** item to **DIGITAL** to enable recording of digital output from a digital audio device. (See "Setting recording input sources" on page 21.)

## Using the built-in speaker for playback

Set the  (speaker) switch to **ON** to listen to playback from the built-in speaker.

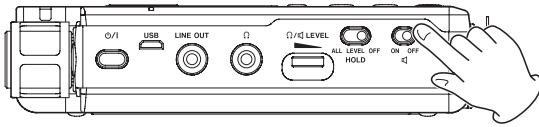

### NOTE

Even if the  (speaker) switch is set to **ON**, the speaker will not output sound when the unit is recording, in recording standby or connected to headphones.

## Connecting monitoring equipment

To listen with an external monitoring system (powered monitor speakers or an amplifier and speakers), connect it to the **LINE OUT** jack.

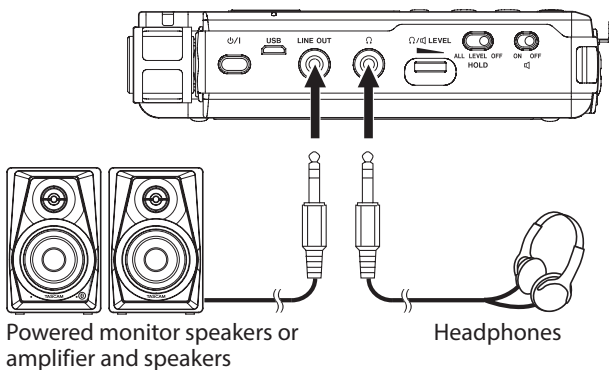

To listen with headphones, connect them to the  (headphone) jack.



Powered monitor speakers or amplifier and speakers

Headphones

## Adjusting playback volume

Use the  (headphone/speaker) **LEVEL** control to adjust the volume output from the built-in speaker and  (headphone) jack. (See “Restricting the headphone output level.” on page 44.)

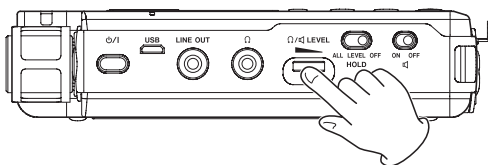

## Connecting cameras

When recording video on a camera, this unit can simultaneously record the same sound as the camera. Connect this unit and the camera as follows to input sound into the camera.

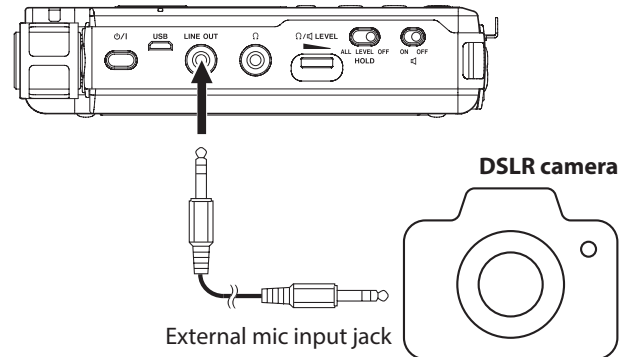

DSLR camera

External mic input jack

### NOTE

When connected to a camera, the line output level can be attenuated 30 dB. (See “Restricting the line output level” on page 44.)

# 4 – Recording

## Recording

With this unit, you can record audio with even better quality by changing the recording format and sampling frequency, as well as setting the various functions, including the limiter, level control and low-cut filter.

Here, we explain basic recording using the **UNI MIC** (built-in directional mics).

### 1. Place the recorder.

Point the built-in directional mics (**UNI MIC**) at the sound source and place the unit in a stable location where there is little vibration. (See "Preparing the recording inputs" on page 17.)

### 2. Select the input source.

Set the input source to **UNI MIC**. (See "Setting recording input sources" on page 21.)

To change where recording files are saved, see "Setting where to save files" on page 21.

### 3. Start recording standby.

Press the **REC** button to start recording standby. The **REC** indicator will blink.

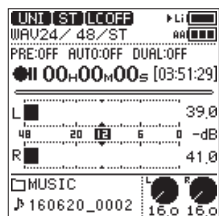

### 4. Adjust the recording level.

Watch the level meters and level indicators as you turn the input level knob to adjust the recording level.

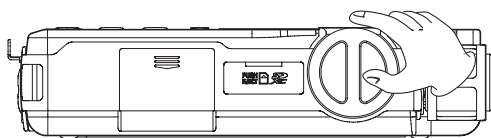

You can check the input level with both the level meters and level indicators.

While watching the level meters, adjust the recording level so that they do not peak with  $-12\text{dB}$  as a guideline.

Distortion could occur if the input level exceeds the peak level. If the peak level is exceeded, an **OVER** icon appears in the peak input level decibel (dB) display area and the **PEAK** level indicator lights.

#### Selecting channels to adjust

- Set the **INPUT LEVEL** switch to **STEREO** to adjust the recording levels of both left and right (L/R) channels simultaneously.
- If you want to change the left-right balance, set the **INPUT LEVEL** switch to **L** or **R** to adjust the recording level of that channel independently.
- If the right and left input levels are different, this difference will be maintained when the **INPUT LEVEL** switch is set to **STEREO** so you can adjust them together again.

#### Changing the mic input sensitivity.

If the peak level is exceeded even when the input level knob is turned down as much as possible, set the **MIC PAD** switch to **ON**.

If the peak level is still exceeded, lower the volume of the sound source or increase the distance between the mics and the sound source.

#### NOTE

- **Recording levels cannot be adjusted if the input source is set to DIGITAL or the level control function is set to AUTO LEVEL.**

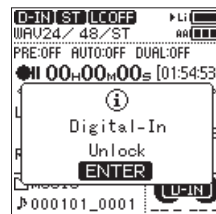

Set to **DIGITAL**

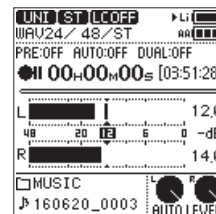

Set to **AUTO LEVEL**

- **MIC PAD is disabled if the input source is set to LINE, EXT LINE or DIGITAL.**

### 5. Start recording.

Press the **REC** button when in recording standby to start recording. The **REC** indicator will stop blinking and stay lit.

#### Pausing recording

Press the **REC** button during recording to pause recording. The **REC** indicator will blink.

Press the **REC** button again to resume recording.

### 6. Stop recording.

Press the **STOP** button to stop recording.

#### CAUTION

*This unit has a high-gain design to allow it to record even sounds that are quiet. For this reason, if the recording level is set high when using an AC adapter, touching the mic might cause you to hear noise (humming or rumbling).*

*Be careful not to touch the built-in mic when recording with it.*

## Remaining recording time display

When the remaining recording time (open card space) becomes 10 minutes or less when recording, the remaining recording time will blink on the Home Screen.

When time runs out, a "Card Full" message will appear and recording will stop.

#### NOTE

*When the file size reaches 2 GB during recording, a new file will be created automatically and recording will continue without pause. Moreover, if the recording time exceeds 24 hours, a new file will be created automatically and recording will continue without pause.*

## Listening while recording (monitoring)

When in recording standby or during recording, the speaker does not output sound even if the  (speaker) switch is set to **ON**.

If you use speakers for monitoring, particularly when recording with mics, the sound output from the speakers could be picked up, resulting in unwanted recording or feedback noise.

Use headphones to monitor the sound while adjusting the input levels or recording.

Use the (headphones/speaker) **LEVEL** volume control to adjust the monitoring level. This does not affect the sound being recorded.

## Setting where to save files

Set the folder where recorded files are saved.

1. Select the MENU screen **BROWSE** item to open the Browse Screen. (See “Basic menu operation procedures” on page 10.)
2. Select the folder where files are saved.
3. Press the **ENTER/MARK** button to confirm the folder where files are saved and return to the Home Screen.  
To create a new folder, see “Creating new folders” on page 34.

## Setting the file format and sampling frequency

Use the items on the REC SETTING screen to set the recorded file format before you start recording. (See “Basic menu operation procedures” on page 10.)

### ■ Setting the file format

Open the **FORMAT** screen and set the file format.

Options	Audio quality	Recording time
WAV(BWF) 24 bit (default)	High	Short
WAV(BWF) 16 bit		
MP3 320 kbps	↓	↓
MP3 256 kbps		
MP3 192 kbps		
MP3 128 kbps		

### NOTE

- *BWF is a format created for broadcasting that has the same sound quality as the standard WAV format. It also uses the same “.wav” file extension as WAV files. In this manual, we distinguish these file types by using the terms BWF and WAV.*
- *WAV/BWF formats are higher quality than MP3 formats.*
- *MP3 formats allow for longer recording than WAV/BWF formats.*
- *With MP3 formats, higher values provide better recording quality.*

### ■ Setting the sampling frequency

Open the **SAMPLE** screen and set the sampling frequency.

Options	Audio quality	Recording time
192.0 kHz	High	Short
176.4 kHz		
96.0 kHz	↓	↓
88.2 kHz		
48.0 kHz (default)		
44.1 kHz		

### NOTE

*When the file format is MP3, 192.0 kHz, 176.4 kHz, 96.0 kHz and 88.2 kHz cannot be selected.*

## Recording in mono (file type setting)

1. Select the REC SETTING screen **FILE TYPE** item to open the **FILE TYPE** screen. (See “Basic menu operation procedures” on page 10.)

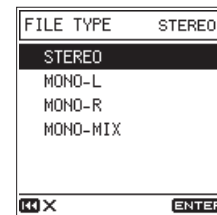

2. Set the recording channels.

Option	Meaning
STEREO (default)	Left and right channel inputs recorded as stereo file
MONO-L	Left channel input recorded as mono file
MONO-R	Right channel input recorded as mono file
MONO-MIX	Left and right channel inputs mixed to mono and recorded as mono file

## Setting recording input sources

Use the I/O SETTING screen **SOURCE** item to set the recording input source.

1. Select the I/O SETTING screen **SOURCE** item to open the **SOURCE** screen. (See “Basic menu operation procedures” on page 10.)

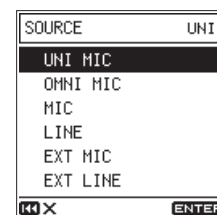

2. Set the input source.

Option	Meaning
UNI MIC (default)	<b>UNI MIC</b> (built-in directional mic) input
OMNI MIC	<b>OMNI MIC</b> (built-in omnidirectional mic) input
MIC	<b>MIC/LINE IN</b> jack XLR input
LINE	<b>MIC/LINE IN</b> jack TRS plug input
EXT MIC	<b>EXT IN</b> jack mic input
EXT LINE	<b>EXT IN</b> jack line input
DIGITAL	<b>DIGITAL IN</b> jack input

# 4 – Recording

## Setting power used by mics

### Using phantom power

1. Set the phantom power voltage to match the connected mics. (See “Setting the phantom power voltage” on page 22.)
2. Set the **PHANTOM** power switch to **ON** only when a condenser microphone that requires phantom power is connected to the **MIC/LINE IN** jack.

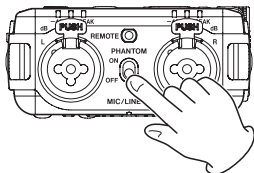

3. When phantom power is turned on, a confirmation pop-up message appears.  
Press the **ENTER/MARK** button to supply phantom power to the **MIC/LINE IN** jack.  
If you set the **PHANTOM** power switch to **OFF** while the confirmation pop-up message is open, the message will close and phantom power will not be enabled.

#### NOTE

- If you set the **PHANTOM** power switch to **ON** when the charge of the battery being used is low, a **BATTERY LOW** pop-up message will open and phantom power will not be enabled.
- When phantom power is being supplied the **+48V** or **+24V** icon will appear

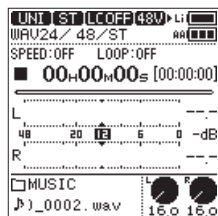

#### CAUTION

- **Do not connect or disconnect mics from the MIC/LINE IN jack while phantom power is ON. Doing so could cause a loud noise and might damage this unit and connected equipment.**
- Turn phantom power **ON** only when using a condenser microphone that requires phantom power. Turning phantom power on when a dynamic mic or other external device that does not require it is connected could damage this unit and connected equipment.
- When using condenser mics that require phantom power and dynamic mics together, be sure to use balanced dynamic mics. Unbalanced dynamic mics cannot be used when phantom power is enabled.
- Supplying phantom power to some ribbon mics will break them. If you are unsure, do not supply phantom power to a ribbon mic.
- Some condenser microphones will not operate when phantom power is set to +24V.
- The battery operation time depends on the mic being used. For details, refer to the mic operation manual.

- When using phantom power during battery operation, the operation time might be reduced drastically depending on the mic. We recommend using a TASCAM PS-P520E AC adapter (sold separately) or, for battery operation, the built-in battery or a TASCAM BP-6AA external battery pack.
- Do not connect or disconnect the AC adapter when using phantom power. The unit could turn off even when batteries are installed, resulting in recorded data becoming damaged or lost.
- When using USB bus power, the unit might not be able to supply phantom power depending on the computer.

#### ■ Setting the phantom power voltage

1. Select the I/O SETTING screen **PHANTOM VOLT** item to open the **PHANTOM VOLT** screen. (See “Basic menu operation procedures” on page 10.)

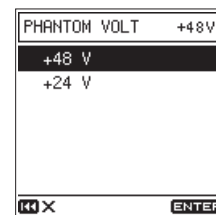

2. Set the supplied phantom power voltage.  
**Options:** +48V (default), +24V

#### NOTE

Battery power will be consumed faster when set to +48V than when set to +24V.

## Using plug-in power

Plug-in power can be supplied when a small condenser mic that requires plug-in power supply is connected to the **EXT IN** jack.

1. Select the **PLUG IN POWER** item on the I/O SETTING screen. (See “Basic menu operation procedures” on page 10.)

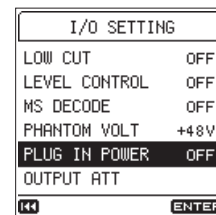

2. Turn plug-in power on or off.  
**Options:** OFF (default), ON

#### CAUTION

When connecting a dynamic mic or external mic that has its own battery, do not turn plug-in power on. If plug-in power is on, it could damage the connected mic.

## Setting the low-cut filter

The low-cut filter can reduce bothersome noise, such as from wind, air-conditioners and projectors.

1. Select the I/O SETTING screen LOW CUT item to open the LOW CUT screen. (See “Basic menu operation procedures” on page 10.)

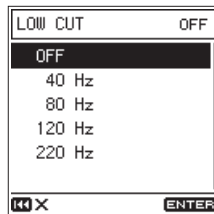

2. Set the cutoff frequency of the low-cut filter during input.

**Options:** OFF (default), 40 Hz, 80 Hz, 120 Hz, 220 Hz

### NOTE

*This setting can also be changed when in recording standby or recording on the FUNCTION screen. In this case, you can change the sound while monitoring the actual sound. (See “Function menu list” on page 13.)*

## Using the limiter

Using the limiter can reduce distortion due to sudden excessive sound input.

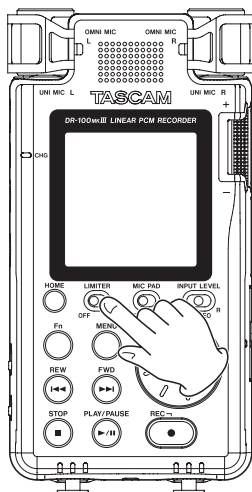

### NOTE

- Distortion of sounds may occur when signals that are very loud are input even if the LIMITER function is activated. In such a case, lower the recording level or increase the distance between the mic and the sound source.
- The limiter is disabled if the input source is set to DIGITAL.
- When the limiter function is being used, the dual ADC function cannot be used at the same time. (See “Improving recording signal-to-noise (Dual ADC function)” on page 25.)

## Using the Level Control Function

You can set the level control function for use with mic input.

1. Select the I/O SETTING screen LEVEL CONTROL item to open the LEVEL CONTROL screen. (See “Basic menu operation procedures” on page 10.)

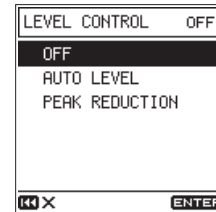

2. Set the operation mode of the level control function.

Option	Meaning
OFF (default)	This turns level control off.
AUTO LEVEL	When the input sound level is too low or too high, the recording volume will be increased or decreased automatically to an appropriate level.
PEAK REDUCTION	This function reduces the recording level automatically to a level that will not distort when input sounds are too loud. The recording level will not be raised automatically. The recording level can be raised manually if required.

### NOTE

- If the input source is set to LINE, EXT LINE or DIGITAL, the level control function is disabled.
- When AUTO LEVEL is selected, the input level knob has no effect because the volume is adjusted automatically.
- You can also change this setting with the FUNCTION screen LEVEL CONTROL item. (See “Function menu list” on page 13.)

# 4 – Recording

## Using mid-side microphones

The mid-side decoder allows recording with mid-side mics.

### 1. Connect the mid-side mic.

Connect the mid-side mic mid to the **MIC/LINE IN L** jack and the side to the **MIC/LINE IN R** jack.

### 2. Set the decoding mode.

Select the **MS DECODE** item on the **I/O SETTING** or **FUNCTION** screen to open the **MS DECODE** screen. (See “Basic menu operation procedures” on page 10.)

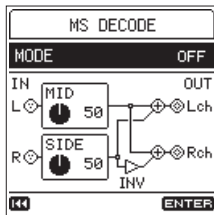

Select the **MODE** item and set the decoding mode when using a mid-side mic.

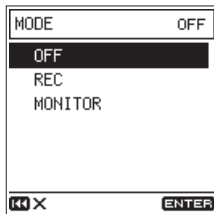

Option	Meaning
OFF (default)	The decoder is not used. When a mid-side mic is connected, always select <b>REC</b> or <b>MONITOR</b> .
REC	Use to record sound after decoding. The monitored sound is also decoded.
MONITOR	Use to record sound that is not decoded. The monitored sound is decoded.

### 3. Adjust the levels.

Adjust the **MID** and **SIDE** levels to adjust the width of the sound. Move the cursor to the item to adjust, and press the **ENTER/MARK** button to enable changing the setting.

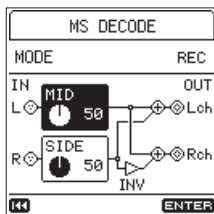

After changing the setting, press the **ENTER/MARK** button to confirm it.

### NOTE

You can also change this setting with the **FUNCTION** screen **MS DECODE** item. (See “Function menu list” on page 13.)

## Setting the characteristics of the digital filter (A/D)

You can set the characteristics of the digital filter used during A/D conversion. This allows alteration of the sound quality after conversion.

1. Select the **I/O SETTING** screen **A/D FILTER** item to open the **A/D FILTER** screen. (See “Basic menu operation procedures” on page 10.)

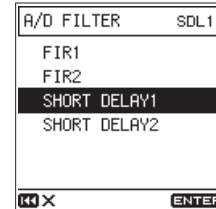

2. Select the A/D filter characteristics.

Option	Meaning
FIR1	A FIR digital filter with a sharp roll-off that sharply cuts signals outside the audio band is used.
FIR2	A FIR digital filter with a slow roll-off that gently cuts signals outside the audio band is used.
SHORT DELAY1 (default)	A SHORT DELAY type digital filter with a sharp roll-off that sharply cuts signals outside the audio band is used.
SHORT DELAY2	A SHORT DELAY type digital filter with a slow roll-off that gently cuts signals outside the audio band is used.

### TIP

#### FIR digital filters

*These filters have an established reputation for audio quality. They feature a tonal quality with both dense rich reverberations and crisp sounds.*

#### SHORT DELAY digital filters

These feature tonal qualities that are close to the original sounds. The starts of sounds and the reverberations are natural without any pre-echo in the impulse response.

## Improving recording signal-to-noise (Dual ADC function)

The dual ADC function realizes even better signal-to-noise performance and can suppress noise even when recording quiet input sounds.

1. Select the I/O SETTING screen DUAL ADC item. (See “Basic menu operation procedures” on page 10.)

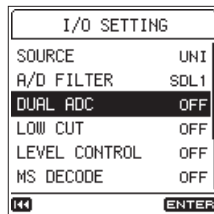

2. Turn the dual ADC function ON or OFF.

**Options:** OFF (default), ON

### NOTE

- This function is disabled if the input source is set to DIGITAL.
- When this function is being used, the following functions cannot be used at the same time.
  - Dual level recording (See “Recording at two different levels (dual level recording)” on page 27.)
  - Dual format recording (See “Recording with two different formats (dual format recording)” on page 27.)
  - Limiter (See “Using the limiter” on page 23.)

## Starting recording automatically (AUTO REC function)

The AUTO REC function can be used to start recording automatically

How it works depends on the operation mode.

### NOTE

When in recording standby, the REC indicator blinks faster than during ordinary recording.

### TIP

By using this in combination with the PRE REC function, you can record events without losing the beginnings of sounds.

## Recording in LEVEL mode

In LEVEL mode, recording starts automatically when the input signal exceeds the set level. You can also set whether the recording pauses or the file is incremented when the input signal goes below the set level.

1. Select the REC SETTING screen AUTO REC item to open the AUTO REC screen. (See “Basic menu operation procedures” on page 10.)

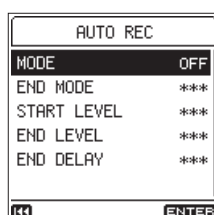

2. Use the MODE item to set the automatic recording function mode to LEVEL.

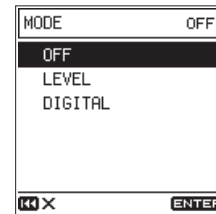

### NOTE

Operation using LEVEL mode is possible even if the input source is set to DIGITAL.

3. Use the END MODE item to set what happens after automatic recording ends. After the input signal goes below the END LEVEL setting and the END DELAY time passes, operation is as follows.

Option	Meaning
PAUSE	Pause, but record to the same file when recording starts again
FILE INC (default)	Pause, and create a new file when recording starts again (file incrementation)

4. Use the START LEVEL item to set the level at which recording starts.  
Recording starts automatically when the input signal exceeds the set level.  
**Options:** OFF, -6 dB, -12 dB (default), -24 dB, -48 dB
5. Use the END LEVEL item to set the level at which recording stops.  
Recording stops automatically when the input signal stays below the set level for the set END DELAY time.  
**Options:** OFF, -6 dB, -12 dB, -24 dB, -48 dB (default)
6. Use the END DELAY item to set the time until the recording stops.  
Recording will continue if the input signal becomes higher than the END LEVEL before this time elapses.  
**Options:** 1 sec, 2 sec, 3 sec, 4 sec, 5 sec (default)
7. Press the REC [●] button to enter recording standby.  
When in standby, a START LEVEL guide appears on the meters.

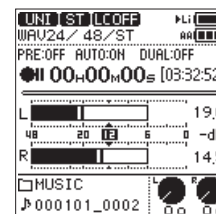

After recording starts, an END LEVEL guide appears on the meters.

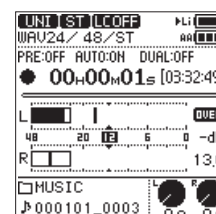

## 4 – Recording

- Press the **STOP** [■] button to stop recording.

### Recording in DIGITAL mode

In DIGITAL mode, recording starts automatically when the input signal exceeds the fixed standard level (−54 dB).

- Select the **REC SETTING** screen **AUTO REC** item to open the **AUTO REC** screen. (See “Basic menu operation procedures” on page 10.)

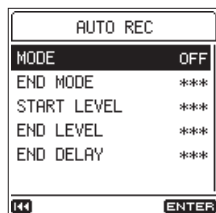

- Use the **MODE** item to set the automatic recording function mode to **DIGITAL**.

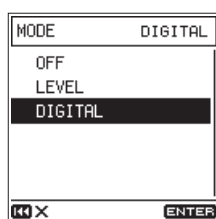

- Press the **REC** [●] button to enter recording standby. In DIGITAL mode, recording starts automatically when the input signal exceeds the fixed standard level (−54 dB). Moreover, after recording starts, track divisions from the digital input (CD, DAT or MD) will be detected and new files will be created automatically.
- Press the **STOP** [■] button to stop recording.

### Capturing the moment before recording starts (PRE REC function)

By using prerecording when the unit is in recording standby, you can capture up to two seconds of the signal input before recording is started normally.

- Select the **PRE REC** item on the **REC SETTING** screen. (See “Basic menu operation procedures” on page 10.)

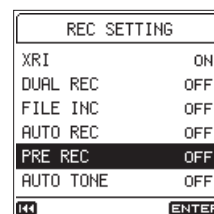

- Turn the pre-recording function **ON** or **OFF**.

**Options:** OFF (default), ON

#### TIP

*By using this in combination with the **AUTO REC** function, you can record events without losing the beginnings of sounds.*

#### NOTE

*If the amount of time in record standby is less than two seconds, the sound for that amount of time is recorded.*

### Create a new file while continuing to record (file incrementing function)

With this function, you can stop recording of the current file and continue recording in a new file. This can be done manually or automatically after a set amount of time has elapsed.

#### NOTE

- When new files are created, incremental numbers are added to the end of each file name.*
- If the name of a file to be created would be the same as that of an existing file, the number will be incremented until the new file has a unique name.*
- A new file cannot be created if the total number of folders and files would exceed 5000.*

### Create a new file manually while recording

During recording, press the ►► button to create a new file while continuing to record.

#### NOTE

*Files shorter than 2 seconds cannot be created (4 seconds if the sampling frequency is 88.2kHz).*

## Creating new files automatically at a set time interval

Recording of the current file can be stopped and a new file can be created automatically when the time set with the REC SETTING screen FILE INC item is exceeded.

Follow the procedures below to set the time that new files are automatically created during recording.

1. Select the REC SETTING screen FILE INC item to open the FILE INC screen. (See “Basic menu operation procedures” on page 10.)

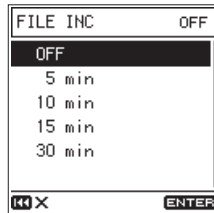

2. Set the time that new files are automatically created.  
Options: OFF (default), 5 min, 10 min, 15 min, 30 min

## Recording two files simultaneously (DUAL REC function)

### Recording at two different levels (dual level recording)

Recording with the level set as high as possible is important for achieving high audio quality, but distortion will occur if the level is too high.

Dual level recording allows a second recording to be recorded simultaneously at a level 12dB lower than the set recording level, resolving this concern.

This allows you to set the recording level high and make a backup recording at a lower level in case distortion occurs.

This function can be used not only with the built-in mics but also with connected external mics.

#### NOTE

- Dual level recording cannot be used if the sampling frequency is 176.4 or 192 kHz.
- This function is disabled if the input source is set to DIGITAL.
- The dual ADC function cannot be used at the same time.
- If the limiter is on, it will not affect the backup recording.

1. Select the REC SETTING screen DUAL REC item to open the DUAL REC screen. (See “Basic menu operation procedures” on page 10.)

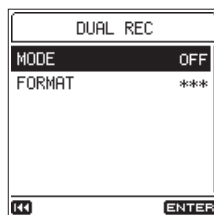

2. Set the dual recording mode to LEVEL.

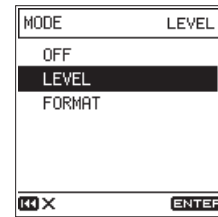

3. Press the REC [●] button to enter recording standby. On the Home Screen, LEVEL will appear next to DUAL in the recording function information area.

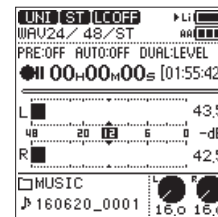

4. Press the REC [●] button again to start dual recording.

### Recording with two different formats (dual format recording)

This unit can simultaneously record the same recording in two different formats (WAV and MP3), creating two separate files.

#### NOTE

- When using dual format recording, set the FORMAT item to WAV16.
  - Dual format recording cannot be used if the sampling frequency is 88.2, 96, 176.4 or 192 kHz.
  - The dual ADC function cannot be used at the same time.
  - If the limiter is on, it will affect both files.
1. Select the REC SETTING screen DUAL REC item to open the DUAL REC screen. (See “Basic menu operation procedures” on page 10.)

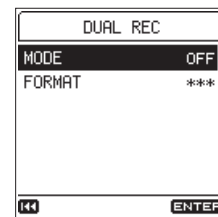

2. Set the dual recording mode to FORMAT.

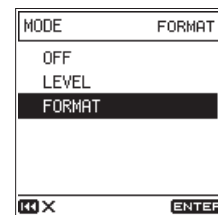

## 4 – Recording

- Select the **FORMAT** item and set the dual recording MP3 format.

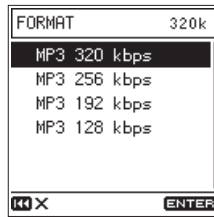

**Options:** MP3 320 kbps (default), MP3 256 kbps, MP3 192 kbps, MP3 128 kbps

- Press the **REC [●]** button to enter recording standby.  
On the Home Screen, **FORMAT** will appear next to **DUAL** in the recording function information area.

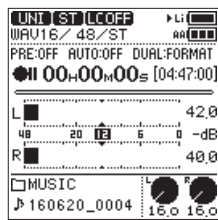

### Names of backup files when using dual recording

A backup file created by dual recording has "\_D" added to its file name.

A backup file created by dual format recording has "\_D" added to its file name, and change to ".mp3" extension.

TASCAM\_0002.WAV

①

TASCAM\_0002\_D.WAV

① ②

TASCAM\_0002\_D.mp3

① ② ③

- Recording file number
- "D" indicates dual recording
- ".mp3" dual format recording backup file extension

### Using the auto tone function

The auto tone function can be used to automatically insert a tone signal (1kHz sine wave) whenever recording starts and stops.

By connecting the **LINE OUT** jack to the audio input jack of a DSLR camera, both units can record the same tone signals to their files. These tones can be used as guides to synchronize the files in video editing software.

For details about how to connect the unit with a DSLR camera, see "Connecting cameras" on page 19.

- Select the **REC SETTING** screen **AUTO TONE** item to open the **AUTO TONE** screen. (See "Basic menu operation procedures" on page 10.)

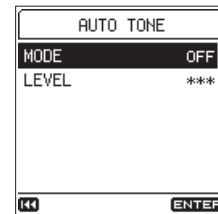

- Select the **MODE** item and set where tone signals are inserted.

**Options:** OFF (default), HEAD (recording start only), HEAD+TAIL (recording start and stop)

- Select the **LEVEL** item and set the tone volume.

**Options:** -12 dB, -18 dB (default), -24 dB, -30 dB, -36 dB

#### NOTE

- Tone signals are not output to headphones.
- Even if you select HEAD+TAIL, no tone signal will be added at the end when recording is paused.

### Turning XRI data recording on/off

When recording with WAV file formats, the XRI data recording function can be turned on to save recording setting information at the time of recording as XRI data.

When shipped new from the factory, the XRI data recording function is set to ON. To turn the XRI data recording setting off, set the **XRI** item on the **REC SETTING** screen to OFF.

- Select the **XRI** item on the **REC SETTING** screen. (See "Basic menu operation procedures" on page 10.)

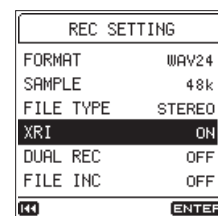

- Turn XRI data recording ON/OFF.

**Options:** OFF, ON (default)

#### NOTE

You can check and delete XRI data. (See "XRI data information" on page 42.)

## Recording times

The table below shows maximum recording times by file format on SD/SDHC/SDXC cards of different capacities (in hours and minutes).

File format (recording setting)		SD/SDHC/SDXC card capacity			
		4 GB	8 GB	32 GB	
WAV (BWF) 16-bit (STEREO)	44.1kHz	6:17	12:35	50:23	
	48kHz	5:47	11:34	46:17	
	88.2kHz	3:08	6:17	25:11	
	96kHz	2:53	5:47	23:08	
	176.4kHz	1:34	3:08	12:35	
	192kHz	1:26	2:33	11:34	
WAV (BWF) 24-bit (STEREO)	44.1kHz	4:11	8:23	33:35	
	48kHz	3:51	7:42	30:51	
	88.2kHz	2:05	4:11	16:47	
	96kHz	1:55	3:51	15:25	
	176.4kHz	1:02	2:05	8:23	
	192kHz	00:57	1:55	7:42	
MP3 (STEREO/MONO)	128kbps	44.1/48kHz	69:26	138:00	555:00
	192kbps	44.1/48kHz	46:17	92:35	370:00
	256kbps	44.1/48kHz	34:43	69:26	277:00
	320kbps	44.1/48kHz	27:46	55:33	222:00

- The recording times shown above are estimates. They might differ depending on the SD/SDHC/SDXC card in use.
- The recording times shown above are not continuous recording times, but rather they are the total possible recording times for the SD/SDHC/SDXC card.
- If the recording time exceeds 24 hours, a new file will be created automatically and recording will continue without pause.
- If recorded in mono WAV format, maximum recording times will be about twice those above.
- If using dual recording in WAV/BWF format, maximum recording times will be about half those above.

# 5 – Playback

## Playing recordings

When the Home Screen is open and playback is stopped or paused, press the **PLAY/PAUSE** [▶/||] button to start playback.

## Pausing playback

When the Home Screen is open, press the **PLAY/PAUSE** [▶/||] or **STOP** [■] button to pause.

Press the **PLAY/PAUSE** [▶/||] button again to resume playback.

## Stopping playback

When the Home Screen is open, press the **STOP** [■] button while paused to return to the beginning of the file.

## Searching backward and forward

When the Home Screen is open and a track is playing back or stopped, press and hold the ◀◀ or ▶▶ button to search forward or backward.

Release the button to stop again or resume playback.

### NOTE

Press and hold the ◀◀ or ▶▶ button to accelerate the search speed.

## Changing the playback position

Turn the wheel while the Home Screen is open when playing, paused or stopped to move the playback position.

Stop turning the wheel to stop again or resume playback.

## Selecting files for playback (skipping)

When the Home Screen is open, press the ◀◀ and ▶▶ buttons to select the file for playback.

Press the ◀◀ button when in the middle of a file to return to the beginning of that file. Press the ◀◀ button when at the beginning of a file to skip to the beginning of the previous file.

If you press the ▶▶ button when located at the beginning or middle of a file, the playback position will skip to the beginning of the next file.

### NOTE

You can also use the browse screen to select files for playback. (See “6 – Working with Files and Folders” on page 32.)

## Repeat playback (LOOP PLAY)

With this function, you can continuously repeat (loop) the playback of an interval between two points.

1. Press the **Fn** button to open the **FUNCTION** screen, and select the **LOOP PLAY** item. (See “Basic menu operation procedures” on page 10.)

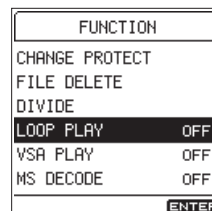

2. Turn the loop playback function on.

**Options:** OFF (default), ON

3. Loop playback mode will be enabled when you return to the Home Screen.

**ENTER IN** appears in the loop playback status area.

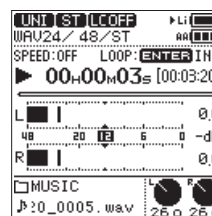

4. During playback or when paused, press the **ENTER/MARK** button to set the **IN** (starting) point.

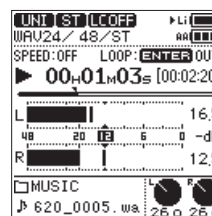

5. Press the **ENTER/MARK** button again to set the **OUT** (ending) point.

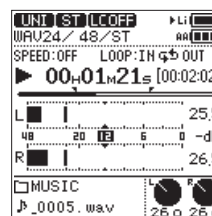

- Press the **ENTER/MARK** button again to clear the IN (starting) and OUT (ending) points.

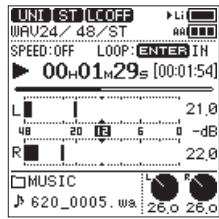

## NOTE

- When in loop playback mode, the mark function is disabled.
- If neither IN or OUT points are set, the entire file will be played repeatedly from start to finish in single track loop playback mode.
- You cannot set the IN and OUT points in different files.
- If you select a different file, the IN and OUT point settings will be cleared.

## Changing the speed of playback (VSA playback)

The unit features a VSA (Variable Speed Audition) playback function that changes the playback speed without changing the pitch.

### CAUTION

*The VSA function cannot be used with files recorded with sampling frequencies of 88.2, 96, 176.4 or 192 kHz. However, the playback speed can still be changed in these cases.*

- Press the **Fn** button to open the **FUNCTION** screen, and select the **VSA PLAY** item. (See "Basic menu operation procedures" on page 10.)

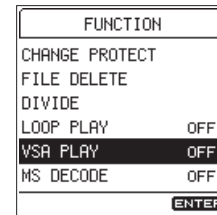

- Press the **ENTER/MARK** button to open the **VSA PLAY** screen.



- Use the **VSA** item to turn the VSA function on.  
**Options:** OFF (default), ON
- Use the **SPEED** item to set the playback speed.  
**Options:** x0.5 – x2.0 (in x0.1 increments, x1.0 default)

# 6 – Working with Files and Folders

You can manage audio files inside the **MUSIC** folder on the SD card in a folder structure.

You can also choose folders and files on the Browse Screen to play or delete them, for example.

Moreover, you can also use the function menu with selected files to protect or delete them, for example.

## NOTE

- *If you connect the unit with a computer by USB, or mount the SD card on a computer using a card reader or other input, you can use the computer to change the folder structure within the **MUSIC** folder and to edit file names.*
- *Using a computer to change the folder structure or edit file names, however, could cause the order of the files to change when played back on the unit.*

## Opening the Browse Screen

To open the Browse Screen, select the **BROWSE** item on the **MENU** screen, and press the **ENTER/MARK** button. (See “Basic menu operation procedures” on page 10.)



The content of the folder that contains the file selected on the Home Screen is shown.

## Icons on the Browse Screen

The meanings of icons that appear on the **BROWSE** Screen are as follows.

### ■ MUSIC folder (F)

This is the top level folder.

### ■ Audio file (🎵🔒)

This is an audio file.

- 🎵 This is an unprotected audio file.
- 🔒 This is a protected audio file.

### ■ Folder (F)

This is a folder that contains subfolders.

### ■ Folder (□)

This is a folder that does not contain subfolders.

### ■ Open folder (📁)

The contents of the folder marked with this icon currently appear on the display.

### ■ New folder (N)

This creates a new folder.

## Basic Browse Screen operations

On the **BROWSE** Screen, folders and audio files appear in lists in the same way files are shown on a computer.

Folders can only be made to two levels.

### ■ Selecting files

1. Turn the wheel to move the cursor to the desired file.
2. Press the **ENTER/MARK** button to select that file and return to the Home Screen.
3. Press the **PLAY/PAUSE** [▶/||] button to select that file, return to the Home Screen and start playback.

### ■ Selecting folders

1. Turn the wheel to move the cursor to the desired folder.
2. Press the **ENTER/MARK** button to select that folder and return to the Home Screen.

### ■ Opening folders

Turn the wheel to move the cursor to the desired folder, and press the ▶ button to open it.

### ■ Closing folders

At any point, press the ◀ button to close that folder and open the folder that contains it.

## File operations

Select the desired file on the Browse Screen, and press the **Fn** button to open the **FILE MENU** screen.

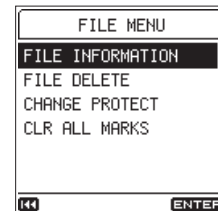

You can use the following functions with the selected file.

### ■ FILE INFORMATION

Information (date/time, size) about the selected file appears.

Executing the **FILE INFORMATION** item opens the **FILE INFORMATION** screen.

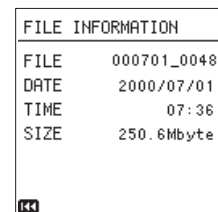

When the **FILE INFORMATION** screen is open, press the ◀ button to return to the Browse Screen.

# 6 – Working with Files and Folders

## ■ FILE DELETE

Delete the selected file.

Executing the **FILE DELETE** item opens a confirmation screen.



Select **YES** to continue execution or select **NO** to cancel. Then, press the **ENTER/MARK** button.

### NOTE

*When the Home Screen is open, you can press the **Fn** button to open the **FUNCTION** Screen where files can also be deleted. (See “Deleting files” on page 34.)*

## ■ CHANGE PROTECT

Use this function to protect or stop protecting the selected file.

Executing the **CHANGE PROTECT** item opens a confirmation screen.

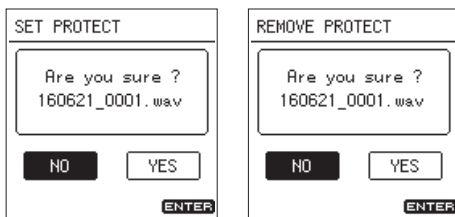

Select **YES** to continue execution or select **NO** to cancel. Then, press the **ENTER/MARK** button.

### NOTE

- If a file is protected, a **lock** mark appears before the file name on the Home Screen and the Browse Screen.
- When the Home Screen is open, you can press the **Fn** button to open the **FUNCTION** Screen where the protection of files can also be changed. (See “Protecting files” on page 34.)

## ■ CLR ALL MARKS

Use this to clear all the marks in the selected file.

Executing the **CLR ALL MARKS** item opens a confirmation screen.



Select **YES** to continue execution or select **NO** to cancel. Then, press the **ENTER/MARK** button.

## Folder operations

Select the desired folder on the Browse Screen, and press the **Fn** button to open the **FOLDER MENU** screen.



You can use the following functions with the selected folder.

### ■ ALL FILES DELETE

This deletes all files in the selected folder.

Executing the **ALL FILES DELETE** item opens a confirmation screen.



Select **YES** to continue execution or select **NO** to cancel. Then, press the **ENTER/MARK** button.

### NOTE

- You cannot erase read-only files and files that are not recognized by this unit.
- Files on a different level of the selected folder will not be deleted.

### ■ FOLDER DELETE

Delete the selected empty folder.

Executing the **FOLDER DELETE** item opens a confirmation screen.



Select **YES** to continue execution or select **NO** to cancel. Then, press the **ENTER/MARK** button.

# 6 – Working with Files and Folders

## Creating new folders

You can create new folders on the Browse Screen.

1. Move the cursor to **NEW FOLDER** at the bottom of the folder list and press the **ENTER/MARK** button.

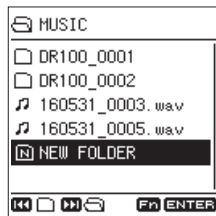

2. After selecting **NEW FOLDER** and pressing the **ENTER/MARK** button, a confirmation screen opens.



3. Select **YES** to continue execution or select **NO** to cancel. Then, press the **ENTER/MARK** button.

This creates a new folder and returns to the Home Screen.

### NOTE

Since the unit supports only a two-level folder structure, **NEW FOLDER** does not appear in second-level folders.

## Protecting files

You can protect and stop protecting the selected file on the Home Screen.

1. While the Home Screen is open when stopped, press the **Fn** button to open the **FUNCTION** screen.
2. Select the **CHANGE PROTECT** item, and press the **ENTER/MARK** button to open a confirmation screen.

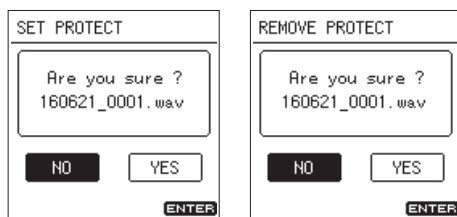

3. Select **YES** to continue execution or select **NO** to cancel. Then, press the **ENTER/MARK** button.

### NOTE

If a file is protected, a lock mark appears before the file name on the Home Screen and the Browse Screen.

## Deleting files

The currently selected file on the Home Screen can be deleted.

1. While the Home Screen is open when stopped, press the **Fn** button to open the **FUNCTION** screen.
2. Select the **FILE DELETE** item, and press the **ENTER/MARK** button to open a confirmation screen.



3. Select **YES** to continue execution or select **NO** to cancel. Then, press the **ENTER/MARK** button.

## Dividing files

A recorded file can be divided manually or at a mark point.

### CAUTION

- *MP3 files cannot be divided.*
- *If the SD card does not have enough open space, division might not be possible.*
- *Division is not possible if the file name would become more than 200 characters long.*
- *Division is not possible if a file that already exists has the same name as the name that would be given to a new file created by division.*
- *Division deletes the original file.*

## Dividing files manually (DIVIDE function)

A recorded file can be divided into two at a specified position.

1. While the Home Screen is open when stopped or paused, press the **Fn** button to open the **FUNCTION** screen.
2. Select the **DIVIDE** item, and press the **ENTER/MARK** button to open the **DIVIDE** screen.

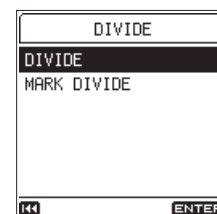

## 6 – Working with Files and Folders

3. Selecting the **DIVIDE** item and pressing the **ENTER/MARK** button will open another **DIVIDE** screen.

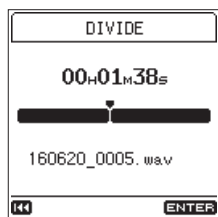

4. Set the division point.  
Use the wheel and skip between marks to move. You can also play the file and listen to it when searching for a desired point.
5. After setting the division point and pressing the **ENTER/MARK** button, a confirmation screen opens.

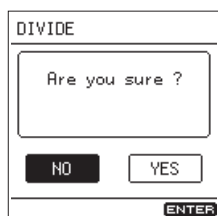

6. Select **YES** to continue execution or select **NO** to cancel. Then, press the **ENTER/MARK** button.

### NOTE

After dividing a file, two new files with "a" and "b" added to the end of the original file name are created.

Examples:

File name before division

160531\_0003.wav

File names after division

160531\_0003\_a.wav (part before division point)

160531\_0003\_b.wav (part after division point)

### TIP

Add marks at positions where you want to divide a file in advance to make them easier to find later. (See "Adding marks" on page 38.)

### Dividing files at marks (MARK DIVIDE function)

Files can be divided at points where marks have been added. (See "Adding marks" on page 38.)

1. While the Home Screen is open when stopped or paused, press the **Fn** button to open the **FUNCTION** screen.
2. Select the **DIVIDE** item and press the **ENTER/MARK** button to open the **DIVIDE** screen.

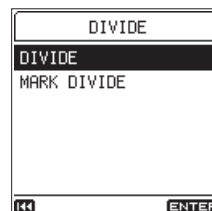

3. Select the **MARK DIVIDE** item, and press the **ENTER/MARK** button to open a confirmation screen.

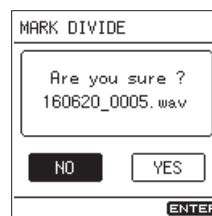

4. Select **YES** to continue execution or select **NO** to cancel. Then, press the **ENTER/MARK** button.

### NOTE

- Division is only possible at **MARK**, **LEVEL** and **TIME** marks. (See "Mark types" on page 38.)
- A **Can't Divide No Mark** message will appear if the file has no marks.
- After dividing a file, new files with "\_01", "\_02", "\_03" and so on added to the end of the original file name are created in order.

Example: file with 2 marks

File name before division

160531\_0003.wav

File names after division

160531\_0003\_01.wav

160531\_0003\_02.wav

160531\_0003\_03.wav

- When used together with the automatic marking function, long recordings can automatically be divided into files with individual songs, for example. (See "Adding marks" on page 38.)

### CAUTION

Mark division is not possible if there is an interval of two seconds or less between marks.

# 6 – Working with Files and Folders

## Setting the file name format

You can select the format of names given to files recorded by this unit.

File names consist of a name part and a number part.

**TASCAM\_0001.WAV**

①      ②

①: File name

②: File number

1. Select the **SYSTEM** screen **FILE NAME** item to open the **FILE NAME** screen. (See “Basic menu operation procedures” on page 10.)



2. Select the **TYPE** item and set the file name format.



Option	Meaning
DATE (default)	The date is used as the file name (in yymmdd format). Example: 160530_0001.wav
WORD	The 6-character file name set with the <b>WORD</b> item is used as the file name. Example: TASCAM_0001.wav

### NOTE

When data is selected, file names are given based on the date of the built-in clock. By setting the clock in advance, the recording date and time can be added to files accurately. (See “Setting the date and time” on page 17.)

## Setting the WORD item

1. On the **TYPE** screen, if you select **WORD**, the **EDIT** item will appear on the **FILE NAME** screen.

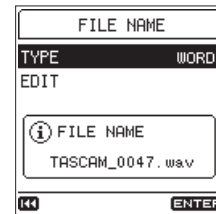

2. Select the **EDIT** item to open the **EDIT** screen.



3. Use the **◀** and **▶** buttons to move the cursor, and turn the wheel to select the character.

In addition to the alphabet and numbers, the following characters can be used:

! # \$ % & ' ( ) + , - . ; = @ [ ] ^ \_ ` { } ~

4. After setting the word, press the **ENTER/MARK** button to confirm it.

## Resetting file numbers

Numbers are added to the names of recorded audio files. These numbers are added in recording order. By default, these numbers are set not to reset (OFF). When set to OFF, the numbers will continue to be added in order even if the card is changed or formatted. This makes file management easier. When set to ON, or when the RESET option is used, the final numbers can be restarted.

1. Select the **SYSTEM** screen **FILE No. RESET** item to open the **FILE No. RESET** screen. (See “Basic menu operation procedures” on page 10.)

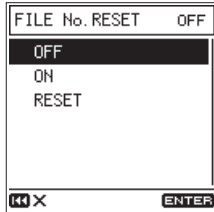

2. Set the file number reset function.

Option	Meaning
OFF (default)	The file number is not reset.
ON	The file number is reset automatically after formatting, when a new folder is created or when all the files in a folder are deleted.
RESET	This resets the file number the next time a file is created.

3. When the **RESET** item is selected, a confirmation screen opens.



4. Select **YES** to continue execution or select **NO** to cancel. Then, press the **ENTER/MARK** button.

# 7 – Mark functions

Marks can be used to cue for playback or as guides for dividing files. Moreover, in addition to adding marks manually, they can also be added automatically in response to the input signal level or at set time intervals.

## Mark types

The mark types and the conditions when they are added are as follows.

Mark name	Condition
MARK	Added manually or when track divisions are detected in digital input
LEVEL	Added when the input signal exceeds the set level
TIME	Added when the set recording time elapses
PEAK	Added when the input signal exceeds the peak level
D IN ERR	Added when digital input synchronization is lost and when it is restored
BOF	Added when an SD card writing error occurs during recording (BOF: buffer overflow)

### NOTE

- The maximum number of marks that can be added to each file is 99. The mark data is stored in the file.
- Mark information added to WAV files can be used with software and equipment that supports the BWF format.
- Mark information added to MP3 files can only be used with this unit.
- Marks cannot be added to protected files. Remove protection to use these functions.

## Adding marks

### Adding marks manually

When playing, recording or in recording standby, press the **ENTER/MARK** button to add a mark at any point.

When a mark is added, a pull-up appears at the bottom of the display.

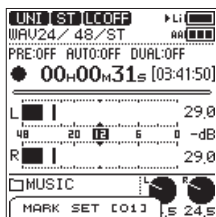

- The [ **xx** ] in the mark name is a number given to all marks that is incremented in order.
- Marks added during playback are saved when playback stops. If you press the **◀◀** or **▶▶** button before stopping, marks will be saved before skipping to another file.
- When using the built-in mics, the sound of pressing the button to add a mark could be recorded. To prevent this, use a remote control.

### Adding marks automatically

The AUTO MARK function can add marks automatically during recording.

1. Select the **MARK SETTING** screen **AUTO MARK** item to open the **AUTO MARK** screen. (See “Basic menu operation procedures” on page 10.)

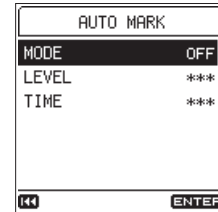

2. Use the **MODE** item to set the automatic mark function mode.

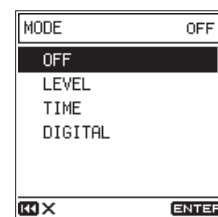

**Options:** OFF (default), LEVEL, TIME, DIGITAL

3. If the automatic mark function mode is set to **LEVEL** or **TIME**, the following settings can also be made.

#### • LEVEL

Marks are added automatically when the input signal exceeds the set level.

**Options:** -6 dB, -12 dB (default), -24 dB, -48 dB

#### • TIME

Marks are added automatically when the set time passes.

**Options:** 5 min, 10 min, 15 min, 30 min, 60 min (default)

### NOTE

After a **LEVEL** mark is added, another **LEVEL** mark will not be added until at least 10 seconds has passed.

## Adding marks at peak levels

Marks can be added automatically when input signals exceed the peak level during recording. Use this to find when the peak level was exceeded after recording.

1. Select the **PEAK MARK** item on the **MARK SETTING** screen. (See “Basic menu operation procedures” on page 10.)



2. Turn the peak mark function on/off.

**Options:** OFF (default), ON

### NOTE

- These marks are added two seconds before the peak level was exceeded.
- After a peak mark is added, another peak mark will not be added until at least 10 seconds have passed.

## Moving between marks (mark skipping)

When stopped, paused or playing back, press the **I◀◀** or **▶▶I** button while pressing the **ENTER/MARK** button to move (skip) to the previous or next mark. When skipping, the mark name appears in a pull-up at the bottom of the display.

Since there are multiple mark types, you can choose which type to use when skipping.

### NOTE

*You cannot move to a mark in a different file.*

1. Select the **MARK SETTING** screen **MARK SKIP** item to open the **MARK SKIP** screen. (See “Basic menu operation procedures” on page 10.)



2. Set the mark skip mode.

**Options:** ALL (default), MARK, LEVEL, TIME, PEAK, DIN ERR, BOF

## Deleting marks

You can delete marks that have been added by this unit when stopped or paused.

1. You can skip to marks that you want to delete when stopped or paused. (See “Moving between marks (mark skipping)” on page 39.)
2. Press the **ENTER/MARK** button to open the confirmation screen.



3. Select **YES** to continue execution or select **NO** to cancel. Then, press the **ENTER/MARK** button.

# 8 – Settings and Information

## Making power and display settings

Make power and display settings for this unit on the **POWER/ DISPLAY** screen. (See “Basic menu operation procedures” on page 10.)

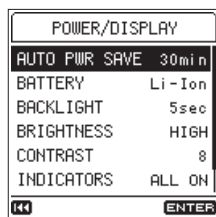

### Setting the automatic power saving function

Select the **AUTO PWR SAVE** item to set the amount of time from when the unit last operated or was used until the unit automatically turns off (enters standby).

**Options:** OFF (unit does not automatically turn off), 3 min, 5 min, 10 min, 30 min (default)

### Set the priority battery type

Set whether to use the built-in battery or the AA batteries first when AA batteries are loaded in the unit.

With one battery type as the priority power source and the other as the backup source, if the amount of remaining power in the priority source becomes insufficient, the unit can automatically switch to the other source and continue operating.

1. Select the **BATTERY** item to open the **BATTERY** screen. (See “Basic menu operation procedures” on page 10.)



2. Select the **PRIORITY** item and set the priority battery type.

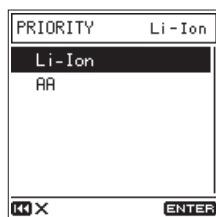

Option	Meaning
Li-Ion (default)	Use the built-in battery battery first
AA	Use the AA batteries first

### CAUTION

If the charge of the backup battery source also becomes too low, the unit will turn off.

### NOTE

- **A** ► appears next to the icon for the type of battery currently being used in the battery supply status area on the Home Screen.
- After switching to the backup battery source, the unit will automatically switch back to the priority source if it becomes charged again.
- If an external power source is connected when operating on power from AA batteries, that source will be used instead and operation will continue while recharging.

### Setting the AA battery type

Set the type of AA batteries used.

This setting is used to show the amount of remaining AA battery charge and determine if the unit has enough power for normal operation.

1. Select the **BATTERY** item to open the **BATTERY** screen. (See “Basic menu operation procedures” on page 10.)
2. Select the **AA TYPE** item and set the type of AA batteries used.

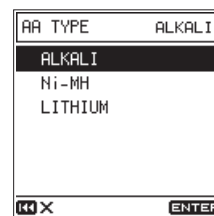

**Options:** ALKALI (alkaline, default), Ni-MH (nickel-metal hydride), LITHIUM (lithium)

### Setting the backlight

Select the **BACKLIGHT** item and set the time until the backlight automatically turns OFF after the last operation when operating on battery power.

**Options:** OFF (always off), 5 sec (default), 10 sec, 15 sec, 30 sec, ALWAYS

### TIP

Even when set to OFF or ALWAYS you can turn the backlight on or off by pressing and holding the **HOME** button when the Home Screen is open.

### Setting the backlight brightness

Select the **BRIGHTNESS** item and set the backlight brightness.

**Options:** HIGH (default), MID, LOW

### Adjusting the display contrast

Select the **CONTRAST** item and set the display contrast.

**Options:** 1 – 20 (default: 8)

### Turning indicators off

Select the **INDICATORS** item and set whether to turn off the level and REC indicators.

**Options:** ALL ON (default), LEVEL OFF, ALL OFF

## Setting the peak level function

### ■ Setting the peak level value

Set the peak level at which the **OVER** icon appears and the **PEAK** level indicator lights.

1. Select the **PEAK LEVEL** item, and open the **PEAK LEVEL** screen. (See “Basic menu operation procedures” on page 10.)



2. Select the **LEVEL** item and set the peak level value.

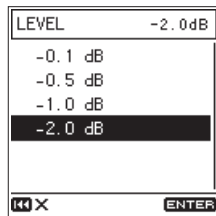

**Options:** -0.1 dB, -0.5 dB, -1.0 dB, -2.0 dB (default)

### ■ Setting the peak hold time

Set the level meter peak hold time.

1. Select the **PEAK LEVEL** item, and open the **PEAK LEVEL** screen. (See “Basic menu operation procedures” on page 10.)
2. Select the **HOLD** item, and set the level meter peak hold time.

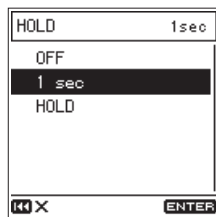

**Options:** OFF, 1 sec (default), HOLD (always show)

### ■ Clearing held peak levels

When **HOLD** is selected on the **HOLD** screen, peak indicators will remain until cleared.

When the Home Screen is open, press and hold the **Fn** button to clear held peaks.

## Viewing information

Use the **INFORMATION** screen to view various types of information about the unit.

Follow the procedures below to view the **INFORMATION** screen.

1. Select the **SYSTEM** screen **INFORMATION** item to open the Information Screen. (See “Basic menu operation procedures” on page 10.)

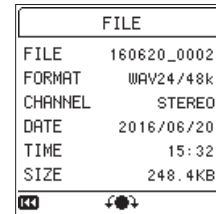

The Information Screen has four pages. The **FILE** page opens first.

2. Turn the wheel to change the page shown.

#### FILE page

Shows information about the currently loaded audio file

#### CARD page

Shows the use status of the currently loaded SD card

#### Firmware page

Shows the unit's system firmware version.

#### XRI page

This shows XRI data recorded in WAV (BWF) files.

## File information page

The **FILE** page shows information about the currently loaded audio file.

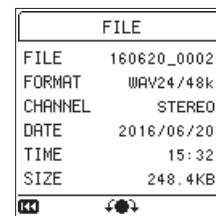

### ■ FILE

The file name

### ■ FORMAT

Shows the audio file type.

For WAV files, this shows the bit length and sampling frequency (Hz).

For MP3 files, this shows the bit rate (kbps) and sampling frequency (Hz).

### ■ CHANNEL

Shows if it is stereo or mono.

### ■ DATE

Shows the file creation date.

### ■ TIME

Shows the file creation time.

# 8 – Settings and Information

## ■ SIZE

Shows the file size.

### NOTE

You can also check this screen with the **FUNCTION** screen **FILE INFORMATION** item. (See “Function menu list” on page 13.)

## Card information page

The **CARD** page shows the status of the currently loaded SD card.

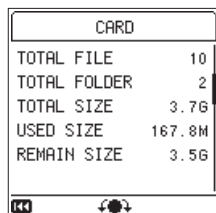

CARD	
TOTAL FILE	10
TOTAL FOLDER	2
TOTAL SIZE	3.76
USED SIZE	167.8M
REMAIN SIZE	3.56

## ■ TOTAL FILE

Shows the number of playable files contained by the **MUSIC** folder.

## ■ TOTAL FOLDER

Shows the total number of folders in the **MUSIC** folder.

## ■ TOTAL SIZE

Shows the total SD card capacity.

## ■ USED SIZE

Shows the amount of space used on the SD card.

## ■ REMAIN SIZE

Shows the amount of space unused on the SD card.

## Firmware version page

The **FIRMWARE** page shows the firmware version used by the unit.

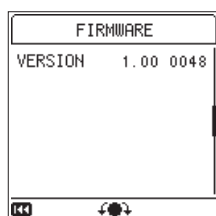

FIRMWARE	
VERSION	1.00 0048

## ■ VERSION

Shows the system firmware version used by the unit.

## XRI date the information page

The **XRI** page shows the **XRI** (eXtended Recording Information) data, which includes the input volume and other recording settings, added to **WAV** (**BWF**) files.

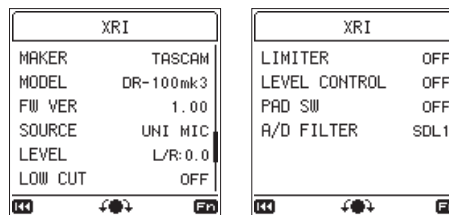

XRI	
MAKER	TASCAM
MODEL	DR-100mk3
FW VER	1.00
SOURCE	UNI MIC
LEVEL	L/R: 0.0
LOW CUT	OFF

XRI	
LIMITER	OFF
LEVEL CONTROL	OFF
PAD SW	OFF
A/D FILTER	SDL1

### NOTE

You can also check this screen with the **FUNCTION** screen **FILE INFORMATION** item. (See “Function menu list” on page 13.)

## ■ Deleting XRI data

1. When the **XRI** page is open, press the **Fn** button to open the **XRI** menu.



2. The **XRI DELETE** item will be selected, so press the **ENTER/MARK** button to open a confirmation screen.



3. Select **YES** to continue execution or select **NO** to cancel. Then, press the **ENTER/MARK** button.

## Restoring factory default settings

Use this to restore various settings to their factory default values.

1. Select the **SYSTEM** screen **INITIALIZE** item, and press the **ENTER/MARK** button to open a confirmation screen. (See “Basic menu operation procedures” on page 10.)



2. Select **YES** to continue execution or select **NO** to cancel. Then, press the **ENTER/MARK** button.

### NOTE

*Initializing the unit does not reset the date and time or language settings.*

## Formatting SD cards

Formatting will erase all the data on the SD card.

Back up important recording data to a computer, for example before formatting a card.

Formatting automatically creates new “**MUSIC**” and “**UTILITY**” folders as well as a “**dr-1.sys**” file.

### CAUTION

*When formatting a card, the unit should be powered by a TASCAM PS-P520E AC adapter (sold separately) or batteries (built-in or AA) with sufficient remaining power. Proper formatting is not possible if the unit turns off (enters standby) during formatting.*

1. Select the **SYSTEM** screen **MEDIA FORMAT** item to open the **MEDIA FORMAT** screen. (See “Basic menu operation procedures” on page 10.)

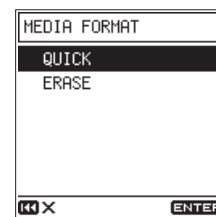

2. Select the type of formatting.

Option	Meaning
QUICK (default)	Execute quick formatting.
ERASE	Erase and format the card.

### NOTE

- *Using the ERASE option might restore an SD card that has decreased writing performance due to repeated use. Execute an ERASE formatting if “Write error REC continue” or “Card slow Check BOF mark” messages appear during recording.*
  - *ERASE formatting checks the memory for errors while formatting, so it takes more time than QUICK formatting.*
3. Press the **ENTER/MARK** button to open the confirmation screen.



QUICK selected



ERASE selected

4. Select **YES** to continue execution or select **NO** to cancel. Then, press the **ENTER/MARK** button.

## 8 – Settings and Information

### Power-on recording function

When the unit is off (in standby mode), press and hold the **REC** [●] button while pressing the power button to turn it on and start recording immediately.

Otherwise, the unit operates normally after starting up.

### Attenuating the output

#### Restricting the line output level

When the unit's line output is input to a camera, the output level can be attenuated 30 dB.

1. Select the **I/O SETTING** screen **OUTPUT ATT** item to open the **OUTPUT ATT** screen. (See "Basic menu operation procedures" on page 10.)



2. Select the **LINE** item and set the output level of the **LINE OUT** jack.

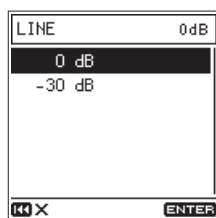

**Options:** 0 dB (default), -30 dB

#### Restricting the headphone output level.

The volume might differ depending on the headphones used.

Make settings suitable for the headphones being used. The default value (**EAR PROTECTION**) is low in order to protect hearing.

1. Select the **I/O SETTING** screen **OUTPUT ATT** item to open the **OUTPUT ATT** screen. (See "Basic menu operation procedures" on page 10.)

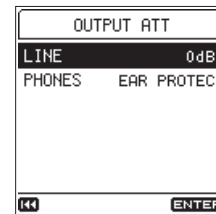

2. Select the **PHONES** item and set the output level of the Ω (headphone) jack.

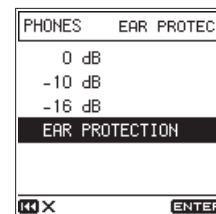

**Options:** 0 dB, -10 dB, -16 dB, **EAR PROTECTION\*** (default)

\*Output level recommended by the European Union

# 9 – Connecting with a Computer

By connecting this unit with a computer using a commercially-available USB cable, you can transfer audio files on the SD card in the unit to a computer, as well as transfer audio files on the computer to the SD card in the unit.

This unit can handle audio files of the following formats.

**WAV (BWF):** 44.1/48/88.2/96/176.4/192kHz, 16/24-bit  
**MP3:** 44.1/48kHz, 128/192/256/320kbps

## NOTE

- We recommend connecting this unit to a computer that supports **USB 2.0 HIGH SPEED** mass storage class.
  - Instead of using USB to connect the unit and a computer, you can also conduct the same operations by removing the SD card from the unit and connecting it directly to a computer that has a built-in SD card slot or by using a card reader.
  - Both WAV and BWF files use the same ".wav" extension.
1. Use a USB cable (A to Micro-B) to connect a computer to the unit's **USB** port.

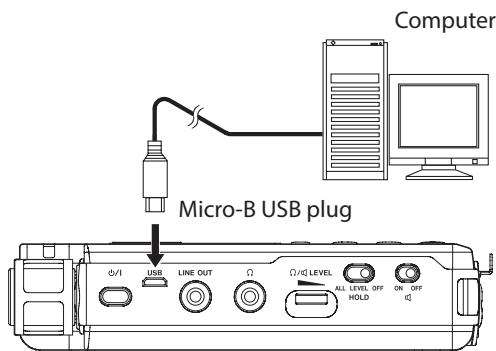

## CAUTION

*The unit should be connected directly with the computer instead of via a USB hub.*

2. Select the **SYSTEM** screen **USB STORAGE** item, and press the **ENTER/MARK** button to open a screen confirming connection with the computer. (See "Basic menu operation procedures" on page 10.)



3. Select **YES** to continue execution or select **NO** to cancel. Then, press the **ENTER/MARK** button.

The unit enters USB storage mode and connects with the computer

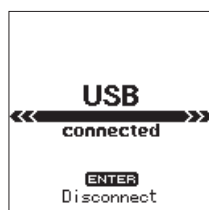

Make sure that the SD card is inserted in the unit properly.

4. This unit appears on the computer as an external drive named "**DR-100MKIII**" (if the card was formatted by this unit).

## NOTE

*Power is supplied from the USB port if the USB cable is connected to the unit even if it contains batteries. (USB bus power is prioritized.)*

## Transferring files to a computer

1. Click the "**DR-100MKIII**" drive on the computer screen to show the "**MUSIC**" and "**UTILITY**" folders.
2. Open the "**MUSIC**" folder and drag and drop the files that you want to transfer to the computer to destinations of your choice.

## Transferring files from a computer

1. Click the "**DR-100MKIII**" drive on the computer screen to show the "**MUSIC**" and "**UTILITY**" folders.
2. Copy the audio files on the computer that you want to the "**MUSIC**" folder.

## TIP

- You can manage the "**MUSIC**" folder from the computer.
- You can create subfolders in the "**MUSIC**" folder up to the second level for use with this unit. Subfolders can be made to two levels. The unit cannot recognize subfolders and audio files on the third level or below.
- If you name the subfolders and music files, these names will appear on the screen of this unit.

## Disconnecting from a computer

Before disconnecting the USB cable, use the proper procedures for your computer to unmount the unit (as an external drive).

See the computer's operation manual for instructions about how to unmount an external volume.

Press the **ENTER/MARK** button to disconnect from the computer and return to the Home Screen.

# 10 – Using the REMOTE jack

This unit has a **REMOTE** jack.

Connect a TASCAM RC-3F footswitch or TASCAM RC-10 wired remote control (both sold separately) here to enable remote operation of this unit.

## Using a remote control (TASCAM RC-10)

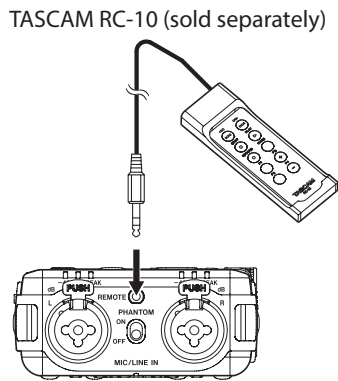

## Setting up a remote control

1. Select the **SYSTEM** screen **REMOTE** item to open the **REMOTE** screen. (See “Basic menu operation procedures” on page 10.)

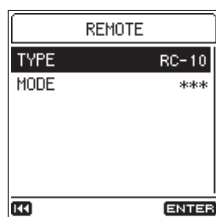

2. Set the **TYPE** item to **RC-10** (default).

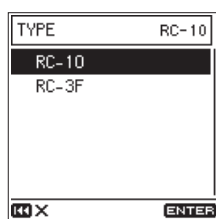

### Function button operations

Function button			
F1	F2	F3	F4
INPUT L VOL+	INPUT L VOL-	INPUT VOL+	INPUT VOL-

## Using the remote control

Press the function (F1–F4) buttons on the wired remote control to use the operations assigned to them on the **REMOTE** screen.

## Using a footswitch (TASCAM RC-3F)

TASCAM RC-3F (sold separately)

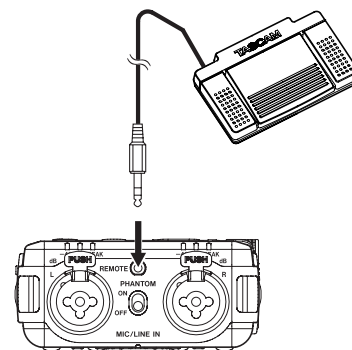

## Setting up the footswitch

1. Select the **SYSTEM** screen **REMOTE** item to open the **REMOTE** screen. (See “Basic menu operation procedures” on page 10.)
2. Set the **TYPE** item to **RC-3F** (default: **RC-10**).

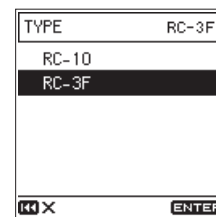

3. Select the **MODE** item and set the footswitch mode.



**Options:** **PLAY** (default), **REC1**, **REC2**, **MINUTES**

MODE	Footswitch		
	L	C	R
PLAY	⏪	▶/⏸	▶▶
REC1	■	●/⏸	FILE INC
REC2	■	●/⏸	MARK SET
MINUTES	⏮*	▶/⏸	USA ON/OFF

\* During playback to move back a 3 seconds.

## Using the footswitch

Press the pedals of the footswitch to use the operations assigned to them by the **REMOTE** screen **MODE** item.

# 11 – Messages

The following is a list of the pop-up messages that might appear on the unit under certain conditions.

Refer to this list if one of these pop-up messages appears on the DR-100MKIII and you want to check the meaning or determine a proper response.

Message	Meaning and response
ALL HOLD on	The input level knob and all buttons have been disabled by the <b>HOLD</b> switch.
LEVEL HOLD on	The input level knob has been disabled by the <b>HOLD</b> switch.
Battery empty	Recharge the built-in battery or replace the removable batteries.
Battery low	
No card	Load an SD card.
Card protected	Move the write-protection switch to the unlocked position in order to record or erase data on the SD card.
Card error	The SD card was not recognized. Change the SD card.
Card full	The SD card has no remaining space.
Format error Format card	The SD card is not formatted properly or the card is broken. Press the <b>ENTER/MARK</b> button to start formatting. <u>Formatting will erase all the data on the SD card.</u>
Invalid card Change card	Something might be wrong with the SD card. Change the SD card.
MBR error Init card	The SD card is not formatted properly or the card is broken. Press the <b>ENTER/MARK</b> button to start formatting. <u>Formatting will erase all the data on the SD card. If formatting is not possible, change the SD card.</u>
Write error REC continue	Writing to the SD card timed out. This has caused audio to be interrupted and noise to occur. A BOF mark is added at the point when audio was interrupted.
Card slow Check BOF mark	SD card writing performance has become worse. A BOF mark has been added at the point when audio was interrupted because writing to the SD card timed out. Check the audio around the BOF mark. <u>Execute the erase format function or change the SD card.</u>
Invalid sys file Make sys file	The system file required to operate this unit is invalid. Press the <b>ENTER/MARK</b> button to create a system file.
No sys file Make sys file	The system file is missing. This unit requires a system file for operation. Press the <b>ENTER/MARK</b> button to create a system file.

Message	Meaning and response
Non-supported	The audio file is not a supported format. Please see "9 – Connecting with a Computer" on page 45 for file formats that this unit can use.
File full	Recording is not possible because the total number of folders and files would exceed the limit of 5000.
File not found	A file cannot be found or a file might be damaged. Please check that file.
Can't delete File protected	Remove protection from a file before trying to delete it.
Can't divide File too short	The file is too short, so it cannot be divided.
Can't divide Current file MP3	MP3 files cannot be divided.
Can't divide Dup file name	The divide function would cause the file name to be the same as that of an existing file in the same folder. Use a computer to change the file name.
Can't divide No mark	Files that do not have marks cannot be divided with this function.
Can't divide Short interval	Mark division will not work when the interval between marks is two seconds or less.
Can't divide No file	There is no audio file.
Can't divide File name err	Division is not possible because the file name would exceed the limit of 200 characters. Use a computer to change the file name.
MARK full	The number of marks has reached the limit of 99.
Can't delete Not empty	You cannot delete a folder that contains files. Delete all the files in the folder and try again.
No XRI data	No XRI data has been saved in the file. Turn the XRI data recording function ON before starting recording. XRI data cannot be saved when recording MP3 files.
Can't MARK File protected	Marks cannot be added because the file is protected from writing. Remove protection from a file if you want to add marks to it.
Can't MARK File length	Marks cannot be added because the file is too short.
Digital-In Unlock	Nothing is connected to the digital input ( <b>DIGITAL IN</b> ) jack or the signal is not being input correctly. Check the digital connection.
Digital-In Lock	Digital input has been properly detected.
DIN sample Unmatch	The digital input sampling frequency does not match the recording setting.
I/O too short	The IN and OUT points are too close together. Set them with at least 1 second between them.
Thermal Alert Connect USB PWR	The internal temperature has become higher or lower when using the built-in battery or AA batteries. You can continue to use the unit by powering it with a USB connection.
Thermal Alert	The internal temperature has become higher or lower. The system will shut down automatically.

# 11 – Messages

Message	Meaning and response
No DUAL REC now high SAMPLE	Dual level recording cannot be used if the sampling frequency is 176.4 or 192 kHz. Dual format recording cannot be used if the sampling frequency is 88.2, 96, 176.4 or 192 kHz.
No DUAL REC now SOURCE is DIGITAL	Dual format recording cannot be used if the input source is DIGITAL.
Can't save data	If any of these errors occurs, turn the unit off and restart it.
File error	If the power cannot be turned off, remove the AA batteries, disconnect the TASCAM PS-P520E AC adapter (sold separately) and disconnect the TASCAM BP-6AA battery pack.
Not continued	
Player error	
Writing failed	
Error-XX (XX is a number.)	

# 12 – Troubleshooting

If you are having trouble with the operation of this unit, please try the following before seeking repair. If these measures do not solve the problem, please contact the store where you bought the unit or TEAC customer support.

## ■ The unit will not turn on.

- Confirm that the built-in battery has enough charge or that the replaceable batteries are installed correctly.
- Confirm that the TASCAM PS-P520E AC adapter (sold separately) power plug and the USB connector are securely connected. The unit might not operate properly through a USB hub.
- Confirm that the **HOLD** switch is set to **OFF**.

## ■ The unit turns off automatically.

- Is the automatic power saving function on?(See "Setting the automatic power saving function" on page 40.)
- Since this unit complies with the European Standby Power Regulations (ErP), the automatic power saving function operates regardless of whether the unit is being powered by an AC adapter or batteries. If you do not want to use the automatic power saving function, set it to "OFF". (The factory default setting is "30 min".)

## ■ The CHG indicator alternately lights orange and green.

- Proper charging might not be possible in a location that is too hot or too cold. Charging is possible when the temperature is between 0–30°C.

## ■ The remaining charge of the built-in battery is not shown accurately

- The remaining charge of the built-in battery might not be shown accurately when the unit is purchased. Discharge and charge the battery completely once to enable the unit to relearn the remaining battery charge and show it accurately.

## ■ The unit does not function.

- Confirm that the **HOLD** switch is set to **OFF**.
- The unit will not function when in USB storage mode.
- If operation becomes abnormal, press and hold the  $\phi / I$  (power) button for at least 10 seconds while pressing the **STOP** button. This will force the unit to turn off (start standby mode).

## ■ The SD card is not recognized.

- Confirm that the SD card is inserted completely.

## ■ No sound is output.

- Confirm the unit's headphone/speaker output level.
- Check the monitoring system connections and volume level.
- No sound is output from the speaker in the following conditions.
  - The  $\square$  (speaker) switch is set to **OFF**
  - The unit is recording or in recording standby
  - Headphones are connected

## ■ Recording is not possible.

- Confirm that the the SD card has enough open space.
- Recording becomes impossible when the total number of files reaches 5000.

## ■ The input sound is extremely quiet or loud.

- Check input level settings.
- Check the output levels of connected external equipment.

## ■ The output sounds unnatural.

- Check the playback speed (VSA playback function).
- Confirm that the level control function is not on.

## ■ I cannot erase a file.

- A protected (read only) file cannot be erased.

## ■ This unit's files do not appear on the computer.

- Confirm that the unit is properly connected to the computer using its USB port. The unit might not operate properly if connected through a USB hub.
- Confirm that the unit is in USB storage mode.

## ■ I accidentally set the wrong language.

- Press the  $\phi / I$  (power) button to turn it off, and then press the  $\phi / I$  (power) button again while pressing the **MENU** button.

The language selection menu where you can set the language appears.

# 13 – Specifications

---

## Ratings

---

### ■ Recording media

SD card	(64 MB–2 GB)
SDHC card	(4 GB–32 GB)
SDXC card	(48 GB–128 GB)

### ■ Recording/playback formats

WAV (BWF):	44.1/48/88.2/96/176.4/192kHz, 16/24-bit
MP3:	44.1/48kHz, 128/192/256/320kbps

### ■ Number of channels

2 channels (stereo)

---

## Input/output ratings

---

### Analog audio input and output ratings

#### ■ MIC/LINE IN jacks (XLR support phantom power)

Connectors:

XLR-3-31  
(1: GND, 2: HOT, 3: COLD)

6.3mm (1/4") standard TRS jacks  
(Tip: HOT, Ring: COLD, Sleeve: GND)

##### When MIC input source selected

Maximum input level: +2 dBu (PAD on)  
Minimum input level: -70.5 dBu (PAD off)  
Input impedance

- XLR input: 2 k $\Omega$  or more
- TRS input: 20 k $\Omega$  or more

##### When LINE input source selected

Maximum input level: +24 dBu  
Nominal input level: +4 dBu  
Input impedance: 20 k $\Omega$  or more

#### ■ EXT IN jack (can provide plug-in power)

Connector: 3.5mm (1/8") stereo mini jack

##### When EXT MIC input source selected

Maximum input level: -2.8 dBu (PAD on)  
Minimum input level: -62.8 dBu (PAD off)  
Input impedance: 50 k $\Omega$  or more

##### When EXT LINE input source selected

Maximum input level: +6 dBV  
Nominal input level: -10 dBV  
Input impedance: 2 k $\Omega$  or more

#### ■ LINE OUT jack

Connector: 3.5mm (1/8") stereo mini jack  
Output impedance: 200  $\Omega$

##### When LINE input source selected

Nominal output level: -14 dBV  
Maximum output level: +6 dBV

##### At other times

Nominal output level: -10 dBV  
Maximum output level: +6 dBV

#### ■ $\Omega$ (headphone) jack

Connector: 3.5mm (1/8") stereo mini jack  
Maximum output: 40mW + 40mW (when headphones connected, into 32  $\Omega$  load)

#### ■ Built-in speaker

0.4W (mono)

---

## Digital input

#### ■ DIGITAL IN connector

Connector: 3.5mm (1/8") TRS jack (using dedicated conversion cable)  
Format: IEC60958-3 (S/PDIF)

---

## Control input/output ratings

#### ■ USB port

Connector type: Micro-B  
Format: USB 2.0 HIGH SPEED mass storage class

#### ■ REMOTE jack

Connector: 2.5mm (3/32") TRS jack

---

## Audio performance

---

#### ■ Frequency response

MIC/LINE IN (MIC, PAD On) to LINE OUT  
MIC/LINE IN (LINE) to LINE OUT  
EXT IN (MIC, PAD On) to LINE OUT  
EXT IN (LINE) to LINE OUT  
20 Hz–20 kHz +0.5 dB/–1 dB  
(44.1/48kHz sampling frequency, JEITA)  
20 Hz–40 kHz +0.5 dB/–2 dB  
(88.2/96kHz sampling frequency, JEITA)  
20 Hz–80 kHz +0.5 dB/–4 dB  
(176.4kHz/192kHz sampling frequency, JEITA)

#### ■ Distortion

MIC/LINE IN (MIC, PAD On) to LINE OUT  
MIC/LINE IN (LINE, +20dBu In) to LINE OUT  
EXT IN (MIC, PAD On) to LINE OUT  
EXT IN (LINE) to LINE OUT  
0.007% or less  
(44.1/48/88.2/96/176.4/192kHz sampling frequency, JEITA)

#### ■ S/N ratio

MIC/LINE IN (MIC, PAD On) to LINE OUT  
MIC/LINE IN (LINE) to LINE OUT  
EXT IN (MIC, PAD On) to LINE OUT  
EXT IN (LINE) to LINE OUT  
102 dB or more  
(44.1/48/88.2/96/176.4/192kHz sampling frequency, JEITA)

#### ■ Equivalent input noise (EIN)

124 dBu or lower

Note: based on JEITA CP-2150

# 13 – Specifications

## General

### ■ Power

- Built-in lithium-ion rechargeable battery
- 2 AA batteries (alkaline, NiMH or lithium-ion)
- USB bus power from a computer
- AC adapter (TASCAM PS-P520E, sold separately)
- External battery pack (TASCAM BP-6AA, sold separately)

### ■ Power consumption

- 7.5 W (maximum)

### ■ Battery operation time (continuous operation)

- Using built-in (lithium-ion rechargeable) battery

Use conditions	Operation time (in hours and minutes)
UNI MIC (built-in directional mic) input Phantom power unused STEREO WAV (BWF)/44.1kHz 16-bit recording	About 12 hours
MIC/LINE IN jack/mic input Phantom power used (+48V, 3mA×2 load) STEREO WAV (BWF)/44.1kHz 16-bit recording	About 6 hours

- Using alkaline batteries (EVOLTA)

Use conditions	Operation time (in hours and minutes)
UNI MIC (built-in directional mic) input Phantom power unused STEREO WAV (BWF)/44.1kHz 16-bit recording	About 2:45
MIC/LINE IN jack/mic input Phantom power used (+48V, 3mA×2 load) STEREO WAV (BWF)/44.1kHz 16-bit recording	About 1 hour

- Using NiMH battery (eneloop)

Use conditions	Operation time (in hours and minutes)
UNI MIC (built-in directional mic) input Phantom power unused STEREO WAV (BWF)/44.1kHz 16-bit recording	About 3:30
MIC/LINE IN jack/mic input Phantom power used (+48V, 3mA×2 load) STEREO WAV (BWF)/44.1kHz 16-bit recording	About 2:15

- Using lithium-ion batteries (Energizer Ultimate Lithium)

Use conditions	Operation time (in hours and minutes)
UNI MIC (built-in directional mic) input Phantom power unused STEREO WAV (BWF)/44.1kHz 16-bit recording	About 7 hours
MIC/LINE IN jack/mic input Phantom power used (+48V, 3mA×2 load) STEREO WAV (BWF)/44.1kHz 16-bit recording	About 3:30

### ■ Charging time

- By USB: about 10 hours
- Using PS-P520E: about 4.5 hours

### ■ Dimensions

80 x 155.7 x 35 mm (width × height × depth, excluding protrusions)

### ■ Weight

425 g (including batteries)/375 g (not including batteries)

### ■ Operating temperature range

0°C–40°C (32°F–104°F)

## Dimensional drawings

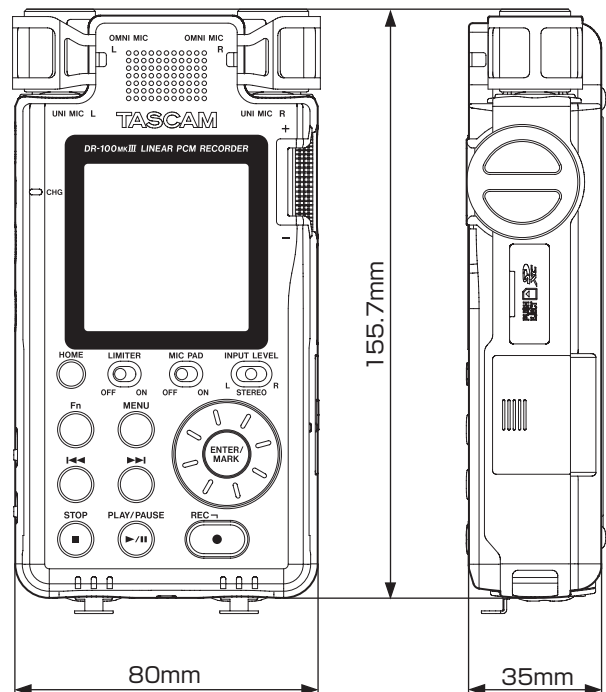

- Illustrations in this manual might differ in part from the actual product.
- Specifications and external appearance might be changed without notification to improve the product.

# TASCAM

## TEAC CORPORATION

Phone: +81-42-356-9143

1-47 Ochiai, Tama-shi, Tokyo 206-8530 Japan

<http://tascam.jp/jp/>

---

## TEAC AMERICA, INC.

Phone: +1-323-726-0303

1834 Gage Road, Montebello, California 90640 USA

<http://tascam.com/>

---

## TEAC MEXICO, S.A. de C.V.

Phone: +52-55-5010-6000

Río Churubusco 364, Colonia Del Carmen, Delegación Coyoacán, CP 04100, México DF, México

<http://teacmexico.net/>

---

## TEAC UK Ltd.

Phone: +44-8451-302511

2 Huxley Road, Surrey Research Park, Guildford, GU2 7RE, United Kingdom

<http://tascam.eu/>

---

## TEAC EUROPE GmbH

Phone: +49-611-71580

Bahnstrasse 12, 65205 Wiesbaden-Erbenheim, Germany

<http://tascam.eu/>

---

## TEAC SALES & TRADING(SHENZHEN) CO., LTD

Phone: +86-755-88311561~2

Room 817, Block A, Hailrun Complex, 6021 Shennan Blvd., Futian District, Shenzhen 518040, China

<http://tascam.cn/>

---