



For more Hi-Fi manuals and set-up information
please visit www.hifiengine.com

TEAC

Service Manual

A-3300/S/SX

A-2300S/SX

Stereo Tape Decks



1. GENERAL DESCRIPTION

The TEAC A-3300S/A-2300S have achieved an enviable reputation for quality since their introduction seven years ago. During this period many design improvements and modifications have been incorporated. However the recent introduction of more versatile, improved tape products called for extensive modification and redesign in order to provide proper utilization of these tapes. Therefore, we have produced the new A-3300SX/A-2300SX, to provide complete flexibility in selection of recording tapes and to meet the stringent requirements of these tapes.

The basic design of the A-3300SX/A-2300SX is highly similar to that of the A-3300S/A-2300S, therefore, information in this service manual may be applied to the A-3300S/A-2300S also.

MODEL	TRACK	TAPE SPEED
A-3300SX-2T	1/2	15 ips, 7-1/2 ips
A-3300SX	1/4	7-1/2 ips, 3-3/4 ips
A-2300SX	1/4	7-1/2 ips, 3-3/4 ips

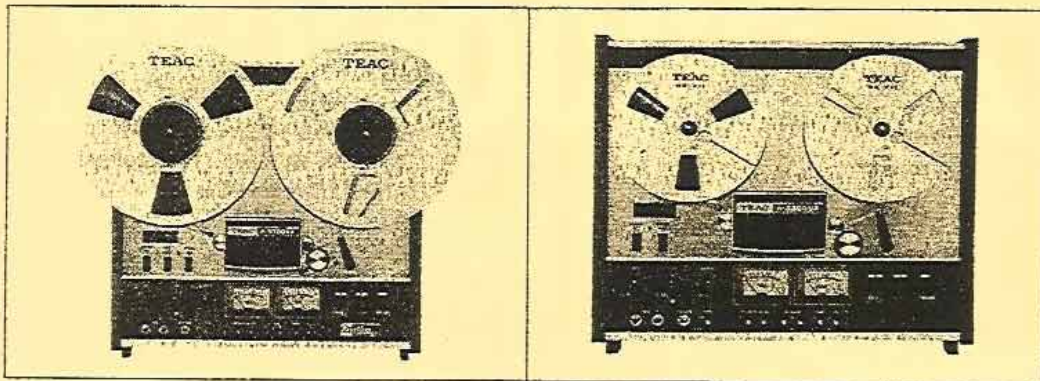

— TABLE OF CONTENTS —

1. GENERAL DESCRIPTION	3
2. SPECIFICATIONS AND SERVICE DATA	4
3. TOOLS FOR TESTING AND MAINTENANCE	6
4. PARTIAL DIS-ASSEMBLY	7
5. TAPE TRANSPORT PARTS LOCATION	9
6. HEAD REPLACEMENT AND ALIGNMENT	10
— MECHANICAL —	
7. MEASUREMENT AND ADJUSTMENT	11
— MECHANICAL —	
8. MEASUREMENT AND ADJUSTMENT	14
— ELECTRICAL —	
9. SERVICING AND MAINTENANCE	21
10. TROUBLE-SHOOTING	22
11. SIMPLIFIED SCHEMATIC	23
WITH LEVEL INDICATIONS	

2. SPECIFICATIONS AND SERVICE DATA

2-1 A-3300SX AND A-3300SX-2T

Track System	1/4 track 2 channel stereophonic 1/4 track 1 channel monophonic 1/2 track 2 channel stereophonic 1/2 track 1 channel monophonic
Heads	Three; Erase, Record and Playback
Reel Size	10-1/2" and 7"
Tape Speed	15 ips and 7-1/2 ips (2T) 7-1/2 ips and 3-3/4 ips (4T)
Motors	1 Dual-Speed Hysteresis Synchronous Capstan Motor 2 Eddy Current Induction Reel Motors
Inputs (Level and Impedance)	MIC: Specified; -60 dB (0.774 mV)/10k ohms Minimum; -70 dB (0.244 mV) LINE: Specified; -8 dB (308 mV)/100k ohms Minimum; -18 dB (97 mV)
Outputs (Level and Impedance)	HEADPHONE: -24 dB (49 mV)/8 ohms LINE: Specified; -8 dB (308 mV)/10k ohms Maximum; -2 dB (615 mV)
Playback Equalization	15 ips: NAB 3180 μ s, 50 μ s 7-1/2 ips: NAB 3180 μ s, 50 μ s 3-3/4 ips: NAB 3180 μ s, 90 μ s
Bias Frequency	100k Hz (\pm 5k Hz, push-pull oscillator)
Power Requirement	100, 117, 220, 240 V AC 50/60 Hz (General Export Model) 117 V AC 60 Hz (U.S.A. and Canada Model) 220 V 50 Hz (Europe Model)
Power Consumption	102 W for A-3300SX-2T 108 W for A-3300SX
Weight	20 kg (44 lbs) net
Dimensions (WHD)	440 x 440 x 210 mm (17-5/16" x 17-5/16" x 8-1/4")

2-2 SERVICE DATA —MECHANICAL—

Tape Speed Deviation and Drift Wow and Flutter	3,000 Hz \pm 30 Hz, within 15 Hz Playback: 0.15% (RMS) at 15 ips 0.18% (RMS) at 7-1/2 ips 0.20% (RMS) at 3-3/4 ips Overall: 0.18% (RMS) at 15 ips 0.20% (RMS) at 7-1/2 ips 0.25% (RMS) at 3-3/4 ips
Pinch Roller Pressure Reel Torque	2.2 kg (4.9 lbs)

REEL SW	TAKE-UP TORQUE	BACK TENSION
LARGE	780 to 820 g-cm (11 to 11.4 oz-inch)	300 to 320 g-cm (4.2 to 4.5 oz-inch)
SMALL	350 to 430 g-cm (5.0 to 6.0 oz-inch)	180 to 210 g-cm (2.5 to 3.0 oz-inch)

Brake Torque	1,600 to 2,000 g-cm (22 to 28 oz-inch)
F.F/REW Time	140 seconds for 1,800 foot tape

Refer to Section 2-5 for Electrical Service Data applicable to all models.

NOTE: As a result of continuing change and improvements during the production run, minor differences may be found between early and later machines.

Value of "dB" in this manual refer to 0 dB = 0.775 V.

2-3 A-2300SX

Track System	1/4 track 2 channel stereophonic 1/4 track 1 channel monophonic
Heads	Three, Erase, Record and playback
Reel Size	7" and 5"
Tape Speed	7-1/2 ips and 3-3/4 ips
Motors	1 Dual-Speed Hysteresis Synchronous Capstan motor 2 Eddy Current Induction reel motors
Inputs (Level and Impedance)	MIC: Specified; -60 dB (0.774 mV)/10k ohms Minimum; -70 dB (0.244 mV) LINE: Specified; -8 dB (308 mV)/100k ohms Minimum; -18 dB (97 mV)
Outputs (Level and Impedance)	HEADPHONE: -24 dB (49 mV)/8 ohms LINE: Specified; -8 dB (308 mV)/10k ohms Maximum; -2 dB (615 mV)
Playback Equalization	7-1/2 ips: NAB 3180 μ s, 50 μ s 3-3/4 ips: NAB 3180 μ s, 90 μ s
Bias Frequency	100k Hz (\pm 5k Hz, push-pull oscillator)
Power Requirement	100, 117, 220, 240 V AC 50/60 Hz (General Export Model) 117 V AC 60 Hz (U.S.A. and Canada Model) 220 V 50 Hz (Europe Model)
Power Consumption	95W
Weight	18 kg (39 lbs) net
Dimensions (WHD)	440 x 392 x 210 mm (17-5/16" x 15-7/16" x 8-1/4")

2-4 SERVICE DATA —MECHANICAL—

Tape Speed Deviation and Drift	3,000 \pm 30 Hz, within 15 Hz
Wow and Flutter	Playback: 0.18% (RMS) at 7-1/2 ips 0.20% (RMS) at 3-3/4 ips Overall: 0.20% (RMS) at 7-1/2 ips 0.25% (RMS) at 3-3/4 ips
Pinch Roller Pressure	2.1 kg (4.6 lbs)
Reel Torque	TAKE-UP TORQUE 380 to 400 g-cm (5.3 to 5.6 oz-inch) BACK TENSION 180 to 210 g-cm (2.5 to 3.0 oz-inch)
Brake Torque	800 to 1,200 g-cm (11 to 17 oz-inch)
Fast Forward/Rewind Time	140 seconds for 1,800 foot tape

2-5 SERVICE DATA —ELECTRICAL— (all models)

Frequency Response	Refer to Frequency Response Limits chart in this manual
Signal-to-noise Ratio	Overall: 48 dB or higher at 15 ips and 7-1/2 ips 46 dB or higher at 3-3/4 ips
Erase Efficiency	68 dB or more at 1k Hz 65 dB or more at 1k Hz (2T) (Measured with input 10 dB higher than the specified input level)
Crosstalk Rejection	35 dB or more, adjacent track at 125 Hz 45 dB or more, channel to channel at 1k Hz
Total Harmonic Distortion	Overall: 1.5% or less at 1k Hz signal

4. PARTIAL DIS-ASSEMBLY

4-1 REMOVING WOODEN SIDES AND REAR PANEL

See illustration for complete dis-assembly instructions. Most amplifier checks and adjustments can be made from the bottom with the (bottom) panel removed.

These adjustments should be performed by experienced technicians, and then only when going through the complete test and check procedures on the unit which is being tested.

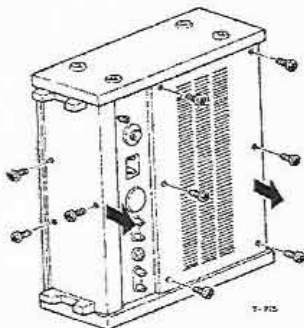
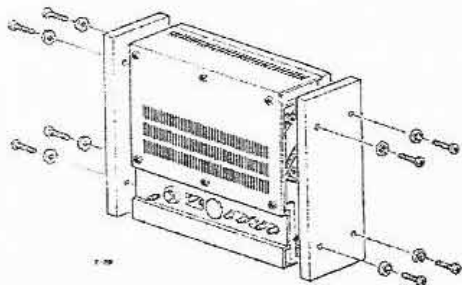

Fig. 4-1 Removing Wooden Sides and Rear and Bottom Panels

4-2 HEAD ASSEMBLY REMOVAL

To change the head assembly as a unit,

1. Note the positions of the wires on the circuit board.
2. Unsolder the wires.
3. Remove the 2 mounting screws, replace the assembly.
4. Solder the wires of the new assembly in exactly the same positions.

NOTE: See page 10, HEAD REPLACEMENT AND ALIGNMENT Section for more detailed explanation.

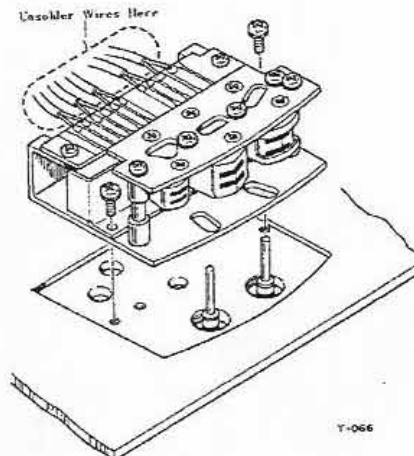

Fig. 4-2 Head Ass'y Removal

4-3 REMOVAL OF CAPSTAN MOTOR

1. Remove the 3 screws (a) holding the capstan motor Plate.
2. Unsolder the 6 wires connecting the capstan motor.
3. Remove the 4 screws holding the capstan motor to the motor plate. Watch for the Rubber Cushions.
4. Loosen the 2 set screws (hex head) in pulley and lift off pulley. Loosen 2 set screws in fan and remove fan.

NOTE: USA, CANADA versions of the A-3300SX/A-2300SX have a different pulley than that shown and have no Frequency Selector switch. See page 13, Section VOLTAGE AND FREQUENCY CONVERSION.

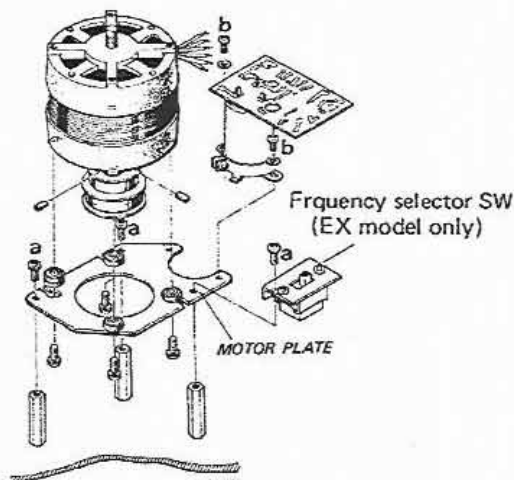

Fig. 4.3 Capstan Motor Removal

4-4 REMOVAL OF CAPSTAN ASSEMBLY

1. Unscrew dust cap (front panel).
2. Remove 2 screws from rear bracket. Allow bracket to drop toward floor of case.
3. Remove capstan belt.
4. Loosen 2 screws in flywheel. Remove flywheel.
5. Remove 3 screws in capstan ass'y.
6. Gently move capstan ass'y up and down until it slides out of panel.

NOTE: When replacing flywheel, position flywheel on capstan ass'y shaft so that end of shaft protrudes slightly from rear of flywheel. A clearance of approx. 0.01" must be maintained between the end of the capstan shaft and the rear bracket.

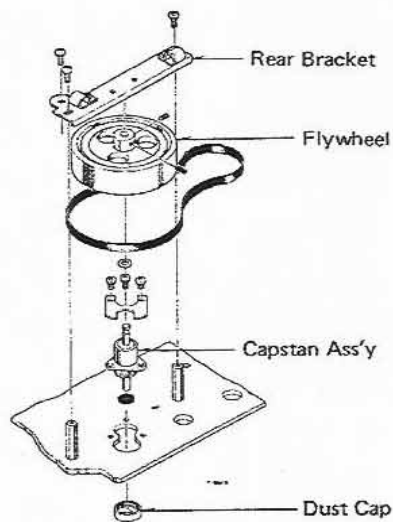

Fig. 4-4 Capstan Ass'y Removal

4-5 REMOVAL OF REEL MOTOR

1. Disconnect the 4 motor wires from terminals and release wire harness straps.
2. Loosen 2 set screws (hex head) in Brake drum(A) and 2 in the Reel Turntable assembly(F). Lift off these parts.
3. Remove 4 screws securing the Brake Assembly(D) to the motor. Carefully lift off the Brake Retainer(B). Do not remove wires connected to the brake solenoid(C) or micro switch.
4. Remove 4 screws securing Reel Motor(E) to chassis through the front panel.

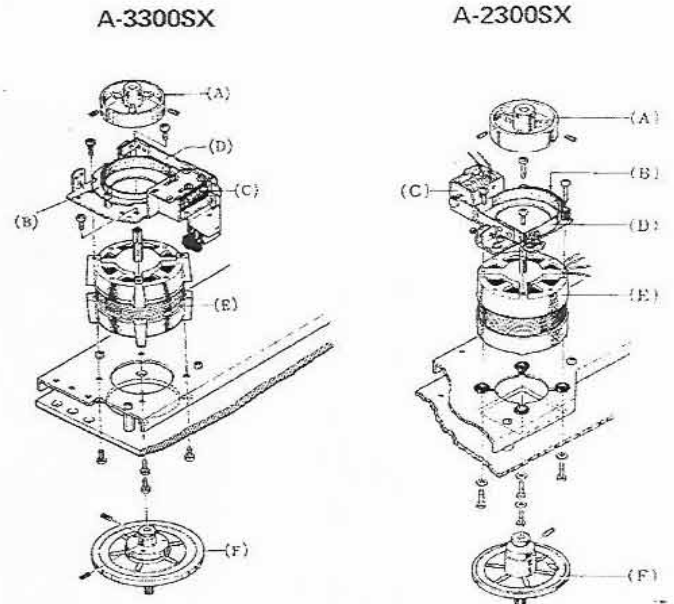

Fig. 4-5 Reel Motors Removal

4-6 REMOVAL OF TENSION ARMS LEFT AND RIGHT

See illustration for complete dis-assembly instructions.

IMPORTANT: After re-assembly check clearance to ascertain that arm moves freely and is not binding.

CAUTION: Do not over-tighten screws holding micro-switches.

Insulating spacer and micro-switches are easily broken by excess pressure.

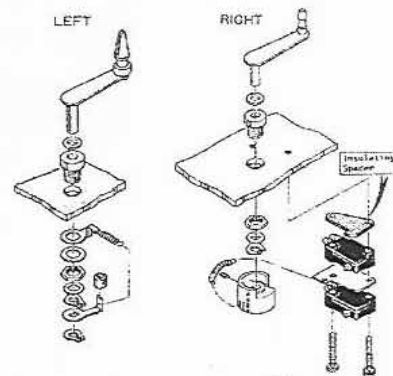
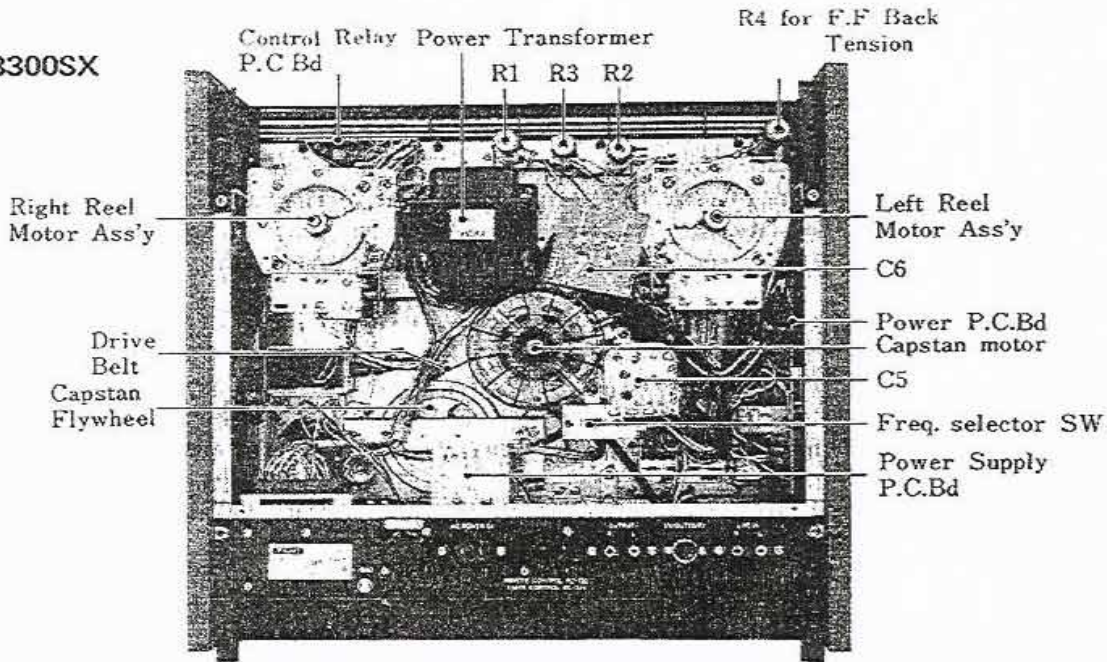

Fig. 4-6 Tension Arms Removal

5. TAPE TRANSPORT PARTS LOCATION

REAR VIEW

A-3300SX



A-2300SX

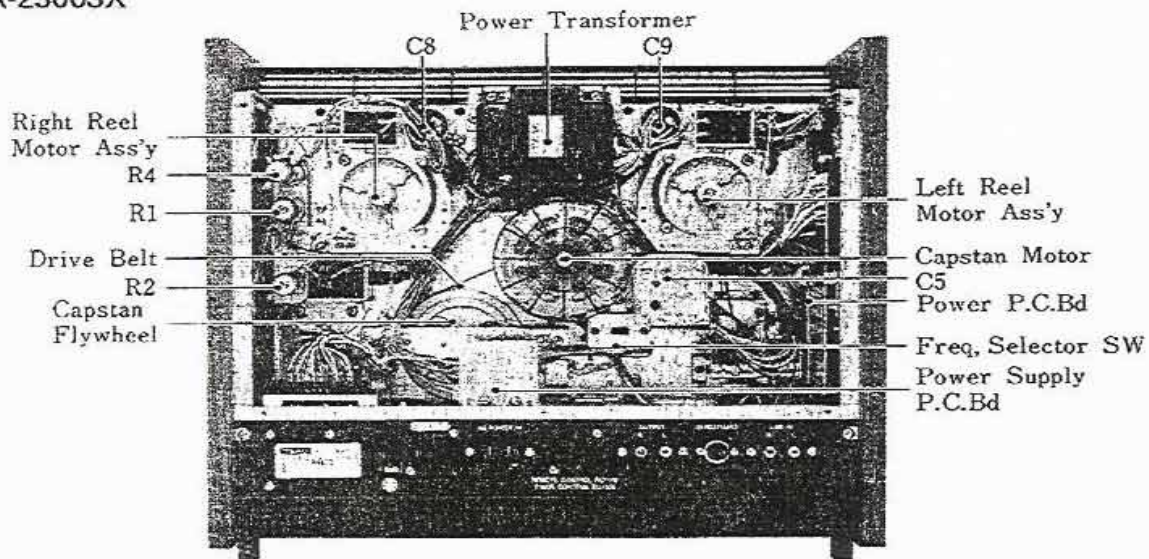

NOTE: Refer to page 12 for the TORQUE MEASUREMENT procedure.
For ordering parts, refer to the exploded view in the PARTS LIST. An accompanying listing provides the correct parts numbers.

6. HEAD REPLACEMENT AND ALIGNMENT — MECHANICAL —

6-1 HEAD REPLACEMENT

To replace a single head a special 2 mm nut driver is required. Remove the 2 nuts (A) on the defective head through the access hole provided. This releases the head from the mounting plate. Note the position of the wires on the circuit board. Connect the new head in the same manner. Replace the nuts securing the new head to the plate. Perform head alignment before operation.

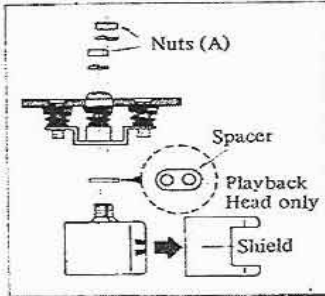

Fig. 6-1 Head Replacement

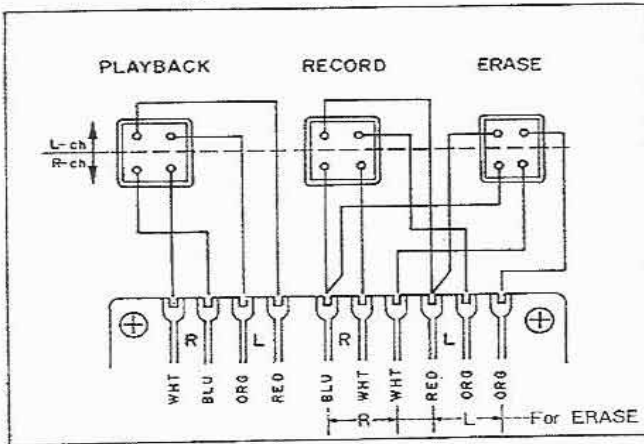
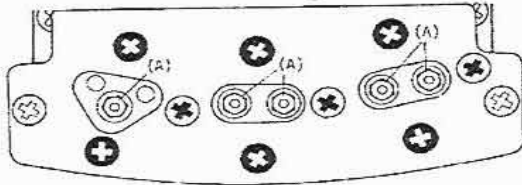

Fig. 6-2 Head Wiring —Rear View—

6-2 HEAD ADJ. SCREWS AND NUTS



- ⊕ Azimuth adj. screws
- ⊕ Height and Tilt adj. screws
- ⊙ Tangency adj. Nuts

Fig. 6-3 Head Adjustment Screws and Nuts

6-3 VISUAL HEAD ALIGNMENT

Since the property of head alignment affects the frequency response on both playback and recording, the head alignment should be done carefully. The head can be adjusted in TILT, TANGENCY, HEIGHT and AZIMUTH. For head alignment, perform the following coarse adjustments first. Then fine alignment should be accomplished electrically while playing back the Test Tape.

**Coarse Adjustment;
Without Tape**

TILT By Height and tilt screws

This alignment is performed by viewing from the side without tape threaded. Check that the head surface is parallel to the tape guide surface.

With Tape

TANGENCY By Head mounting Nuts

Loosen the head mounting nuts. Adjust the head so that the vertical alignment of the head gap is perpendicular to the surface of the tape, then tighten the head mounting Nuts.

HEIGHT By Height and Tilt screws

This alignment is checked visually by looking at the position of the head. The head core for track-1 (inner core) should be even with the inner edge of the tape.

AZIMUTH By Azimuth adj. Screw

Adjust the azimuth adj. screw so that the gap of the head is perpendicular to the tape travel.

NOTE: After this coarse adjustment is made, the adj. screws and the Head mounting nuts should be re-aligned according to electrical head alignment paragraph which follows in this Service Manual.

7-4 MIS-ALIGNMENT OF THE HEADS

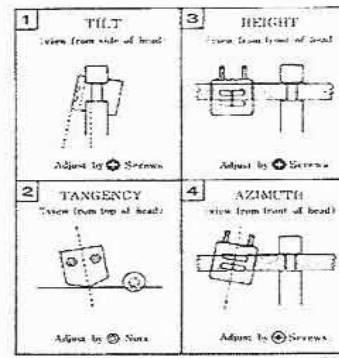

Fig. 6-4 Head Mis-Alignment — Examples —

7. MEASUREMENT AND ADJUSTMENT — MECHANICAL —

7-1 PINCH ROLLER PRESSURE

NOTE: Pinch roller pressure is supplied by the pinch roller spring arm and it is most important that the solenoid plunger be fully bottomed before taking pressure measurement.

1. Load tape or block the shut-off arm in the ON position.
2. Attach a suitable spring scale to the pinch roller shaft.
3. Place the unit in the PLAY mode (▶), and holding the spring scale as illustrated, slowly draw it away from the pinch roller.
4. Do not allow the string to rub against the pinch roller.
5. Note the reading on the spring scale at the instant the pinch roller stops rotating.
6. The scale should indicate 2.1 to 2.3 kg (4.6 to 5.1 lbs), 2.0 to 2.2 kg (4.4 to 4.8 lbs) for A-2300SX.
7. If adjustment is necessary, loosen the 3 screws on the capstan solenoid and position the solenoid for optimum pressure.
8. Adjust solenoid-limit position so that the gap between capstan shaft and pinch roller is approx. 7mm when solenoid is not actuated. Also make sure pinch roller shaft does not contact edit arm B. Limit is adjusted by loosening the mounting screw (A), then sliding limit until proper position is obtained.

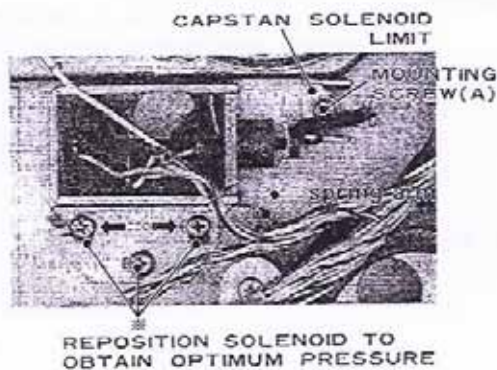

Fig. 7-1 Pressure Measurement and Adj. Locations

7-2 BRAKE TORQUE

The brake torque is actuated mechanically. Pressure is set by the variable spring force. While making these measurements and adjustments, be careful not to bend the brake bands. As brake torque will change with cleaning, brake drums should be cleaned only when absolutely necessary. If cleaning is required, use TEAC cleaner TZ-261B. After cleaning, operate the brakes by depressing the play and STOP buttons several times to completely dry out the brakes before performing the following procedure.

NOTE: Brake adjustments are made with NO power connected to the equipment.

1. Place an empty large hub reel on the left reel table, and fasten one end of a 30" length of string to the reel anchor.
2. Wind several turns of string counterclockwise around the hub and attach a suitable spring scale to the free end of the string and pull on scale until reel begins to turn.
3. Take a reading only when the reel is in steady motion since the force required to overcome static friction will produce a false, excessively high initial reading.
4. The reading should be 1800 g-cm \pm 200 g-cm (22 to 28 oz-in), 1000 g-cm \pm 200 g-cm (11 to 17 oz-inch) for A-2300SX.
5. If adjustment is required, loosen the 2 screws shown and position the brake for optimum torque.
6. The adjustment of the right brake is the same, with the exception that rotations are clockwise. (wind string CLOCKWISE around reel hub)
7. See note at the top of page 12 for explanation of torque measurements.

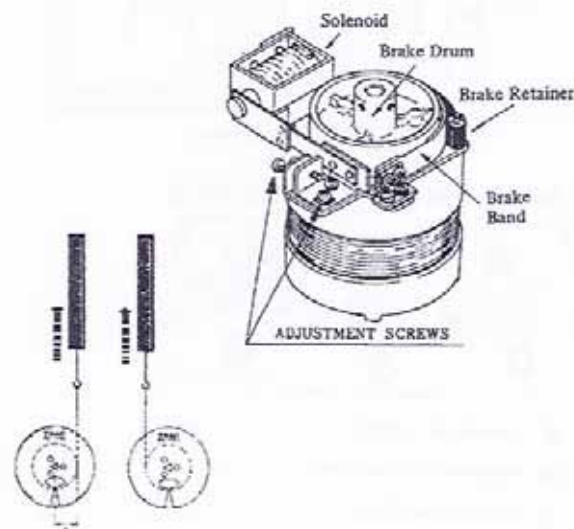

Fig. 7-2 Torque Measurement and Adjustment Location

TORQUE MEASUREMENT PROCEDURE

NOTE: The following torque measurements should be made with a spring scale that is calibrated to read Torque in gram-cm. for a 7" reel with a small reel hub. If the spring scale you are using is calibrated to read Force or Weight in grams the Torque must be calculated using the Formula:

$$\text{Torque (in gm}\cdot\text{cm or oz}\cdot\text{in)} = \text{Weight or Force (in gr. or oz.)} \times \text{radius of hub (in cm or inches)}$$

If you are using a reel with other than the standard 2.5" or 6.0 cm (approx.) diameter hub, the Torque must be calculated using the same formula and substituting the actual radius and Weight or Force reading.

All Torque and Tension measurements must be made with the automatic shut-off switch (right tension arm) held in the ON position.

Brake Torque Measurement should be made using large hub reel with a hub diameter of 4" or 10.2 cm.

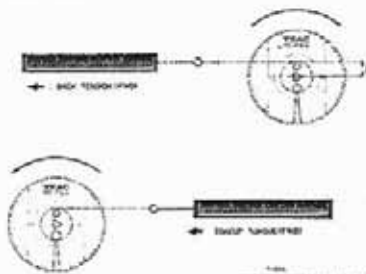

Fig. 7-3 Torque Measurement and Formula.

7-3 TAKE-UP TORQUE

1. Load the empty reel and attach spring scale on the right reel table.
2. Place the deck in the Play mode.
3. Allow the rotation of the reel to slowly draw the scale toward the hub.
4. Hold the spring scale with enough force to allow a steady reading.
5. The torque reading should be approx.:

REEL SW	TAKE-UP
LARGE	780 to 820 g cm (11 to 11.4 oz-inch)
SMALL	350 to 430 g cm (5.0 to 6.0 oz-inch)

380 to 400 g cm (5.3 to 5.6 oz-inch) for A-2300SX

7-4 BACK TENSION

1. Place an empty 7" reel with small hub on the left reel table, and fasten one end of a 30" length of string to the reel anchor.
2. Wind several turns of string counter-clockwise around the hub. Attach spring scale to string.
3. Place the deck in the Play mode.
4. Pull the scale away from the reel against the motor torque with a steady, smooth motion.
5. Note the scale reading while it is in steady motion. (The string must not rub the reel flanges)
6. The calculated value should be approx.:

REEL SW	BACK TENSION
LARGE	300 to 320 g cm (4.2 to 4.5 oz-inch)
SMALL	180 to 210 g cm (2.5 to 3.0 oz-inch)

180 to 210 g cm (2.5 to 3.0 oz-inch) for A-2300SX

Adjustment Location

If necessary, adjust slider of the resistors until you have the correct scale reading for optimum torque. Refer to adj. location below.



A-3300SX



A-2300SX

Fig. 7-4 Adjustment Locations

7-5 TAPE SPEED CHECK

The tape speed should be measured using TEAC flutter free tape, Model YTT-2004 (15 ips), YTT-2003 (7-1/2 ips) and YTT-2002 (3-3/4 ips). These tapes contain a highly accurate 3,000 Hz tone. Connect a digital frequency counter to either line OUTPUT jack. See Fig. 7-5. The indicated frequency should be 3,000 Hz (± 30 Hz) for all speeds during playback of the tape.

7-6 WOW AND FLUTTER CHECK

NOTE: Before performing this measurement, clean the heads and Tape run guides, also check pinch roller pressure, etc.

Use new Test Tape if possible for following checks. Values obtained with different standards of equipment cannot be compared.

PLAYBACK

1. Connect Test equipment to the deck as shown Fig. 7-5. (Except oscillator).
2. Load TEAC YTT-2004 (for 15 ips), YTT-2003 (for 7-1/2 ips) or YTT-2002 (for 3-3/4 ips) and playback tape.
3. Read the indication on the Wow and Flutter meter.
4. The Wow and Flutter should be:
 - 0.15% (RMS) or less for 15 ips
 - 0.18% (RMS) or less for 7-1/2 ips
 - 0.20% (RMS) or less for 3-3/4 ips

OVERALL

1. Connect Test equipment to the deck as shown Fig. 7-5.
2. Load TEAC YTT-8003 (blank tape) Test Tape on the deck and Record a 3,000 Hz input signal.
3. Rewind and playback the recorded signal.
4. The reading on the Meter should be
 - 0.18% (RMS) or less for 15 ips
 - 0.20% (RMS) or less for 7-1/2 ips
 - 0.25% (RMS) or less for 3-3/4 ips

NOTE: These figures apply to any tape position (such as full take-up reel, full supply reel or about mid-point). Also examine the tape counter ass'y for evenness of operation.

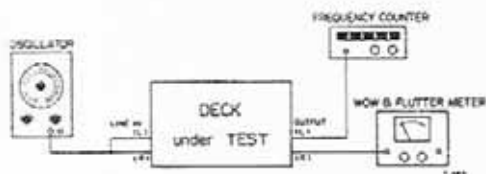

Fig. 7-5 Test Connections for Wow/Flutter and Tape Speed Test

7-7 VOLTAGE AND FREQUENCY CONVERSION

This deck is adjusted to operate on an electric power source of the voltage and frequency specified on the reel tag and packing carton. If it is necessary to change the frequency or voltage requirements of this deck to match your area, use the following procedures.

Always disconnect Power Line Cord before making these changes.

Frequency Conversion: (only Export model)

1. Remove the right side wood panel (4 screws), then the rear/top metal panel (6 screws).
2. Set the power frequency selector slide switch (located next to the capstan motor) to the 50 or 60 position to match the power line frequency in your area.
3. Rotate the center (capstan) motor clockwise with your hand and re-position the belt onto the correct pulley as shown in the motor pulley illustration below. The pulley can be seen by looking through the opening in the side panel. Continue to rotate the motor by hand approximately 10 revolutions to verify belt placement before replacing the side and rear covers.

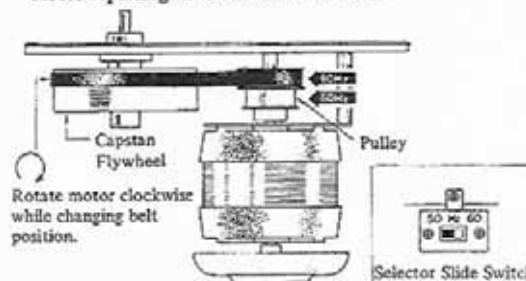

Fig. 7-6 Frequency Conversion

Voltage Conversion: (only Export model)

The deck may be set for 100, 117, 220 or 240 volts. To change the voltage unscrew the fuse in the center of the voltage selector plug. Pull out the plug and reinsert it so the desired voltage shows in the cutout. Reinstall the fuse specified on the label on the rear of the deck.

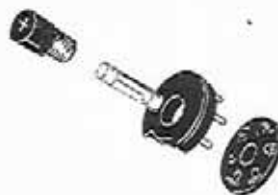

Fig. 7-7 Voltage Conversion

8. MEASUREMENT AND ADJUSTMENT

— ELECTRICAL —

*Before performing maintenance on this unit, thoroughly clean and demagnetize the entire tape path. TEAC maintenance equipment to be used:

- TEAC TZ-261 for cleaning
- TEAC E-3 for demagnetizing or equivalents.

*The electrical adjustment procedure for the A-3300SX and A-2300SX are identical, except that the tape speeds of the two models are different (15 ips, HIGH and 7-1/2 ips LOW speed for A-3300SX-2T, and 7-1/2 ips, HIGH and 3-3/4 ips LOW speed for A-2300SX and A-3300SX.)

The checks and adjustments are, unless otherwise indicated, for the left channel at the LOW tape speed. The same procedures are to be applied for the right channel also and again for both channels at the HIGH tape speed.

*It is important that the deck be set to proper voltage and frequency for your locality.

8-1 ADJUSTMENT LOCATIONS AND ADJUSTMENT POINTS

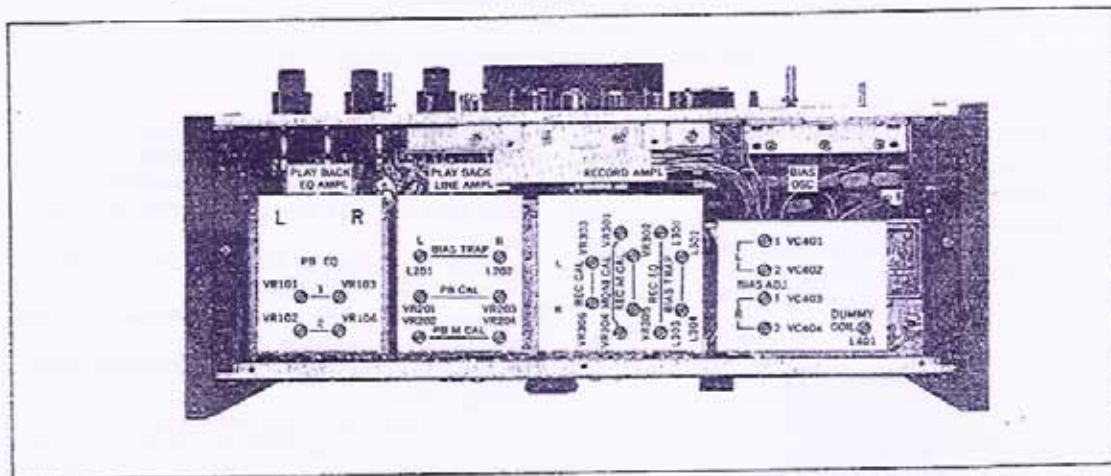

ADJUSTMENT	FOR
VR101/103	P.B.EQ (HIGH)
VR102/104	P.B. EQ (LOW)
VR201/203	P.B.EQ LEVEL
VR202/204	P.B. METER LEVEL
VR301/304	MONITOR LEVEL
VR302/305	REC METER LEVEL
VR303/306	REC LEVEL

ADJUSTMENT	FOR
VC401/403	BIAS ADJ. (1)
VC402/404	BIAS ADJ. (2)
L201/202	BIAS TRAP (OUTPUT)
L301/303	REC EQ
L302/304	BIAS TRAP
L401	DUMMY COIL

8-2 ADJUSTMENT SEQUENCE CHART

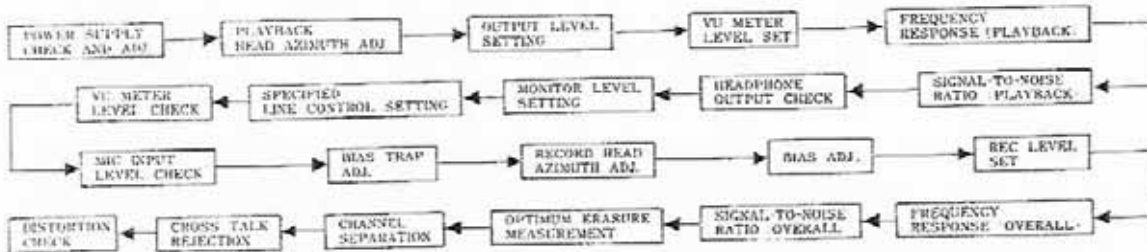

Fig. 8-1 Adjustment Sequence Chart

PLAYBACK PERFORMANCE

8-3 POWER SUPPLY CHECK AND ADJ.

1. Remove wooden panel on left side of the deck for access to the electrical adjustments.
2. Depress power SW to ON.
3. Connect a VTVM between the Power Supply P.C. Bd. Test Point 37 and ground. See Fig. below.
4. Adjust VR-1 for +23 V DC. (see REAR VIEW on p. 9.)

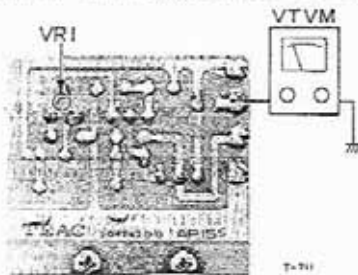

Fig. 8-2 +23 V DC Test Point

8-4 PLAYBACK HEAD AZIMUTH ADJ.

NOTE: Before proceeding with the following head alignments be sure that heads have been properly mounted as to HEIGHT, TILT and TANGENCY. See page 10.

1. Connect a VTVM to either OUTPUT jack.
2. Remove the head Housing (on front panel).
3. Thread the following TEAC Test Tape on the deck. YTT-1003 for 7-1/2 ips (or YTT-1002 for 3-3/4 ips) speed.
4. Play the 16 kHz/-10dB (or 10 kHz for 3-3/4 ips) Test Tone in section 2 of the Test Tape.
5. Slowly rotate the azimuth screw until maximum indication is achieved on VTVM.
6. Connect an oscilloscope to the OUTPUT jacks as shown in Fig. 8-3.
7. Adjust the azimuth screw (If necessary) until the oscilloscope shows that the signals are less than 45° out of phase.
8. Secure this screw with a drop of locking paint.

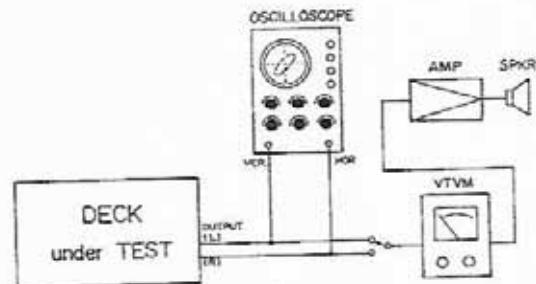

Fig. 8-3 Head Alignment Fine Adjustment Set-up and Test Connections (PLAYBACK)

- FINE ADJUSTMENT -

TAPE SPEED SW LOW
 OUTPUT SW TAPE
 REEL SW SMALL

8-5 OUTPUT LEVEL SETTING

— MAXIMUM OUTPUT LEVEL CHECK —

9. Play the 400 Hz/0 dB tone in Section 1 of the Test Tape.
10. Turn the OUTPUT controls fully clockwise and check for $-2 \text{ dB} \pm 2 \text{ dB}$ (775 mV ~ 488 mV) at OUTPUT jacks.
11. Reduce OUTPUT controls until -8 dB (308 mV) is obtained on the output VTVM.

— SPECIFIED OUTPUT LEVEL SETTING —

12. Set the reference marks of the OUTPUT controls to the 3 o'clock position.
13. Adjust VR-201/VR-203 for -8 dB (308 mV) at OUTPUT jacks.

NOTE: This is the Specified Output level setting. Do not disturb this setting until the remaining adjustments have been completed.

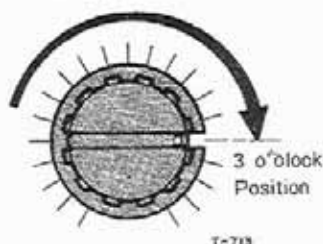

Fig. 8-4 Specified Output Level Setting

8-6 VU METER LEVEL SET

14. Adjust VR-202/204 for 0 VU reading on VU meters.

8-7 FREQUENCY RESPONSE (PLAYBACK)

15. Thread TEAC Test Tape YTT-1003 (or YTT-1002) on the deck.
16. Play Tape and compare readings on VTVM with the response limits given in Fig. 8-5.
17. If adjustment is required, adjust VR-102/104 for LOW speed.

TAPE SPEED SW HIGH

18. Thread a Test Tape YTT-1004 (or YTT-1003) on the deck. Repeat Step 16.
19. If adjustment is required, adjust VR-101/103 for HIGH speed.

NOTE: If the frequency response does not meet specified response limits, especially at the high-end of the spectrum, head should be checked for accumulated dirt or oxides. If clean, head azimuth must be re-adjusted.

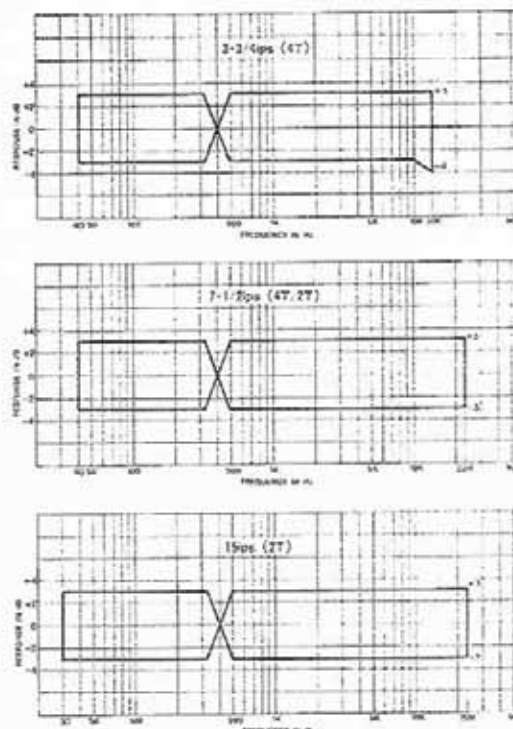

Fig. 8-5 Frequency Response — Playback —

NO ADJUST

8-8 SIGNAL-TO-NOISE RATIO (PLAYBACK)

1. OUTPUT controls should be at the Specified Output Level settings.
2. Thread a blank YTT-8003 on the deck leaving the tape outside the capstan and pinch Roller.
3. Hold the play supply reel stationary and depress the play (▶) button.
4. The VTVM connected to the OUTPUT jacks should indicate readings listed below.

TAPE SPEED	2T	4T
15 ips	52 dB	—
7-1/2 ips	52 dB	50 dB
3-3/4 ips	—	48 dB

NO ADJUST

8-9 HEADPHONE OUTPUT CHECK

1. Connect an 8 ohm non-inductive resistor across the headphone (PHONE) jack.
2. Connect VTVM across the resistor. VTVM should indicate $-24 \text{ dB} \pm 2 \text{ dB}$ (61.5 mV ~ 38.8 mV).

8-10 MONITOR LEVEL SETTING

OUTPUT SW SOURCE

1. Turn LINE controls fully clockwise.
2. Apply a 400 Hz -18 dB (97 mV) signal from AF oscillator to LINE IN jacks.
3. Adjust VR-301/VR-304 for -8 dB (308 mV) at the OUTPUT jacks.

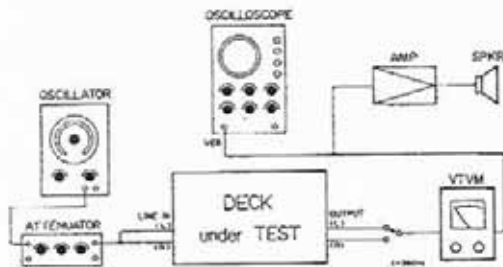

Fig. 8-6 Test Connections for Monitor Check

8-11 SPECIFIED LINE CONTROL SETTING

5. Apply a 400 Hz signal at -8 dB (308 mV) to the LINE IN jacks.
6. Adjust LINE controls for -8 dB (308 mV) at OUTPUT jacks.

NOTE: At this point both the LINE Controls and the OUTPUT Controls are at the "Specified setting". Do not move these controls unless instructed in this procedure to do so. The accuracy of many of the following adjustments and readings depends on these controls being at the "Specified setting".

8-12 VU METER LEVEL CHECK

7. Check VU Meters for 0 VU indication.
8. Adjust VR-302/305 for 0 VU, if necessary.

8-13 MIC INPUT LEVEL CHECK

This is check only, no adjustments are to be made.

1. Set MIC controls fully clockwise.
(Make sure LINE controls are not moved)
2. Apply a 400 Hz signal at -70 dB (0.244 mV) to the MIC input jacks.
3. Check for -8 dB (308 mV) level at OUTPUT jacks.
4. With -8 dB (308 mV) at OUTPUT jacks, MIC input level should be -70 ± 2 dB (0.194 mV \sim 0.308 mV).
5. Return MIC controls fully counter clockwise to prevent noise insertion during following steps.
6. Reset the LINE Controls to the "Specified Setting."

8-14 BIAS TRAP ADJUSTMENT

OUTPUT SW TAPE
 RECORD MODE SW ON
 BIAS and EQ SW 1
 Select REC PAUSE mode

1. Remove all input signals.
2. Connect a VTVM or oscilloscope from ground to the junction of L-302 and C-312 (L-ch) and from ground to the junction of L-304 and C-330 (R-ch). See Fig. 8-7.
3. Adjust L-302 (L-ch) and L-304 (R-ch) for minimum reading on scope or VTVM.
 Use Plastic alignment tool.

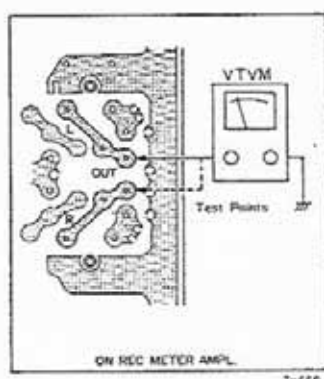

Fig. 8-7 Bias Trap Test Point

8-15 RECORD HEAD AZIMUTH ADJ.

Tape SPEED SW LOW

NOTE: The effect of turning the azimuth screw will register on the VTVM. A slight delay will be noticed. Therefore, the screw must be rotated slightly with a pause to see the effect.

- FINE ADJUSTMENT -

4. Connect a VTVM to the OUTPUT jack and an AF oscillator to the LINE IN jack.
 Set the oscillator to 10 kHz at -18 dB (97 mV).
5. Begin recording (Depress REC and PLAY buttons).
6. While recording, adjust the azimuth screw for maximum reading on the VTVM.

NOTE: It is absolutely essential to accomplish the above adjustment before performing the following adj. to avoid phase errors greater than 45°.

7. Sweep the signal from 40 Hz to 16 kHz for 7-1/2 ips speed (or 40 Hz to 10 kHz for 3-3/4 ips speed) and adjust the azimuth so all signal are within 45° between channels.
8. Secure the screw with insulating locking paint.

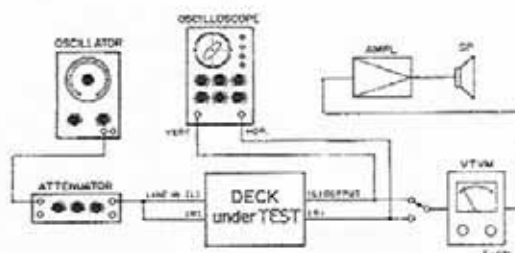

Fig. 8-8 Test Connection for Recording Check

8-16 BIAS ADJUSTMENT

Be sure the Bias Trap have been adjusted per section 8-14 before proceeding.

Tape SPEED SW LOW
 BIAS and EQ SW 1

9. Apply 7 kHz signal at -18 dB (97 mV) to the LINE IN jacks.
10. While recording on the YTT-8003 Test Tape, adjust capacitor VC-401/VC-403 for peak reading on the VTVM, then turn the capacitor clockwise until a decrease of 3 dB from the peak is obtained, (2 dB for 2T at 7-1/2 ips speed)
 BIAS and EQ SW 2
11. Apply 400 Hz signal at -8 dB (308 mV) to the LINE IN jacks.
12. While recording on the YTT-8023 Test Tape, adjust capacitor VC-402/VC-404 for peak Bias.

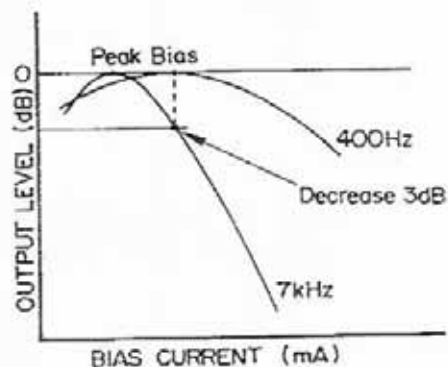

Fig. 8-9 Bias Limits Chart

8-17 REC LEVEL SET

13. Place RECORD BIAS SW and EQ SW to the 1 position.
14. Thread a blank Test Tape YTT-8003 on the unit.
15. Place Tape SPEED to the 7-1/2 ips position.
16. Apply a 400 Hz signal at -8 dB (308 mV) to the LINE IN jacks.
17. Begin recording.
18. Adjust VR-303/306 for -8 dB (308 mV) at OUTPUT jacks.

8-18 FREQUENCY RESPONSE -OVERALL-

NOTE: To avoid saturation of the tape these checks should be made at least 20 dB below the specified input level.

Any Bias signal feeding into the test equipment should be filtered out by adjusting the external Bias Trap.

BIAS and EQ SW 1
Tape SPEED SW LOW

19. Apply signal swept from 40 Hz to the upper frequency limit shown in the applicable Response Limits Chart below, and record this signal on the YTT-8003 test tape for BIAS/EQ 1 and on the YTT-8023 test tape for BIAS/EQ 2.
20. During recording, monitor the tape signal and adjust equalization L-301/L-303 for reading within the applicable Response Limits Chart.

Tape SPEED SW HIGH

21. Repeat this procedure for High Speed also, using the frequency limits given in the applicable Response Limits Chart.

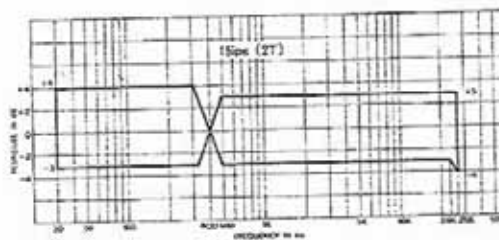
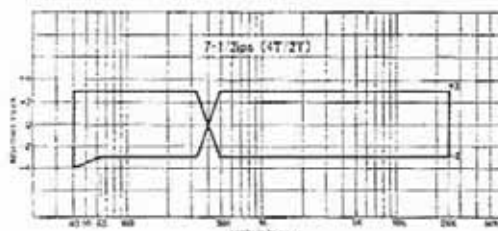
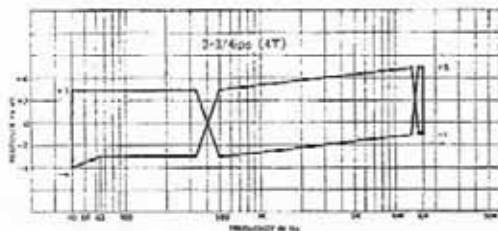

Fig. 8-10 Frequency Response - OVERALL - 1

BIAS and EQ SW 2
Using blank Test Tape TEAC YTT-8023

NOTE: If the response is not uniform, the heads should be cleaned of accumulated oxide and dirt. Then adjust VC-402/404 Bias Adjuster slightly to obtain the best frequency response.

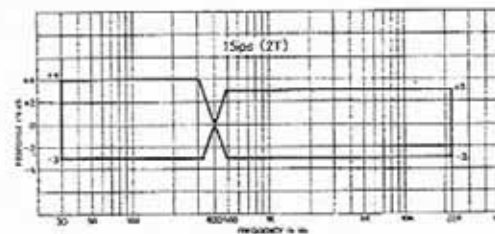
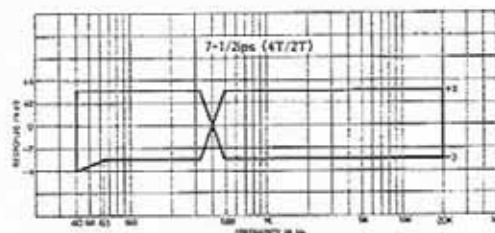
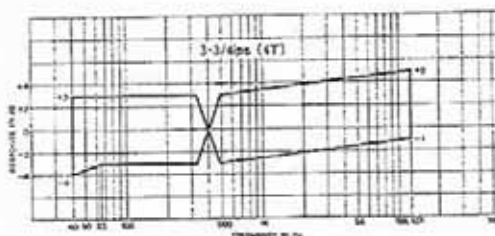

Fig. 8-11 Frequency Response - OVERALL - 2

8-19 SIGNAL-TO-NOISE RATIO -OVERALL-

Using blank Test Tape YTT-8003

1. Output and Line controls should be at the specified positions.
2. Remove the AF oscillator from the LINE IN L, R jacks.
3. Place the deck in the Record mode with "no signal" applied. Note the point on the index counter where recording begins.
4. Rewind the tape to the beginning point and play it back.
5. The noise level as indicated on the VTVM should be readings listed below.

15 ips (2T)	48 dB
7-1/2 ips (2T)	48 dB
7-1/2 ips (4T)	48 dB
3-3/4 ips (4T)	46 dB

8-20 OPTIMUM ERASURE MEASUREMENT

Tape SPEED SW HIGH

1. Thread the TEAC YTT-8003 Test Tape on the unit.
2. Apply a 1 kHz signal at 10 dB above the operating level of -8 dB (308 mV) to the LINE IN jack.
3. Make a 30 seconds recording of the above signal while reading and noting the level of output, then rewind to beginning of this recording.
4. Disconnect the 1 kHz signal source (AF oscillator) from the LINE IN jack.
5. Connect a VTVM to the OUTPUT jack, through a 1 kHz Narrow Band Pass Filter.
6. Put deck in the Record mode and "record" (erase) over this previous recording, then rewind to beginning again.
7. Put deck in Play mode and monitor the output on the VTVM.
8. Difference in output level, between the 1 kHz signal and the "no signal" section level should be more than 65 dB for 2 track decks and 68 dB for 4 track decks.

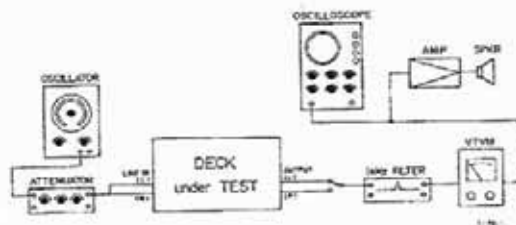

Fig. 8-12 Test Connections for Erase measurement

8-21 CHANNEL SEPARATION

1. Be sure tape is completely bulk erased prior to doing these checks.
2. Apply a 1 kHz signal at -8 dB (308 mV) to L chan.
3. Place deck in Record mode.
4. While recording, measure the OUTPUT on R chan with VTVM connected through a 1 kHz Band Pass Filter. Level should be -45 dB

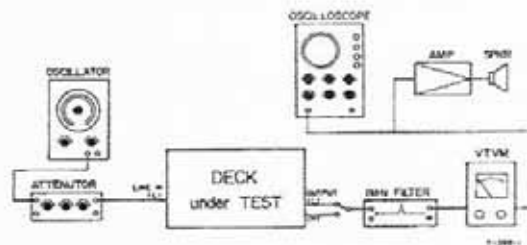

Fig. 8-13 Test Connections for Channel separation check

8-22 TRACK-TO-TRACK CROSS TALK REJECTION (4 TRACK MODELS)

Following is the measurement procedure at 7-1/2 ips using the TEAC standard tape, Type YTT-8003:

1. Thread a blank tape or the YTT-8003 tape on the unit.
2. Apply a 125 Hz signal at -8 dB to the right channel LINE IN jack.
3. Make a 30 second recording of the 125 Hz signal.
4. Interchange the left and right reels and rethread tape on the unit.
5. Connect a VTVM to the right channel OUTPUT jack.
6. Playback the recorded signal portion of tape and monitor the level on the VTVM.
7. The reading should be -35 dB.

8-23 DISTORTION CHECK

Tape SPEED 7-1/2 ips
BIAS and EQ SW 1

1. Thread the TEAC YTT-8003 Test Tape on the unit.
2. Apply a 1 kHz signal to LINE IN jacks.
3. Place the deck in the record mode for about 10 seconds. Rewind and play this recorded section of the tape.
4. Read the indicated value on the distortion analyzer.
5. The distortion factor should be 1.5% or less.

9. SERVICING AND MAINTENANCE

9-1 CLEANING:

TEAC TZ-261A for Head cleaning and TZ-261B for Rubber cleaning should be used. Use for following places.

TZ-261A	TZ-261B
Pinch roller rubber	Motor pulley
Capstan belt	Heads, Brake drums
Counter belt	Capstan shaft
	Tape run guides

9-2 LUBRICATION:

Under normal operating conditions, lubrication is required only once each year. Before lubricating, clean the drive belt and drive pulley... etc. Operate the deck for 30 minutes to 1 hour immediately prior to oiling. After oiling, keep the deck in the upright position for 3 to 4 hours to allow thorough absorption of the oil.

Approximately once each year or after 2000 hours of use, apply TEAC TZ-255 Lubricating Oil to the following places only;

- Pinch roller shaft 1 drop
- Capstan shaft 2 drops
(Remove the dust cap for access to the oil pit)
- Capstan motor 0.5 cc
(Maximum to fill oiling tube)

NOTE: Apply 3 or 4 drops at a time through the oiling tube. The oil level can be seen to drop as the felt material in the motor bearings absorb oil. When the level ceases to drop, no more oil is needed. Do not attempt to force oil into the motor nor exceed the maximum.

Excessive oiling will scatter oil inside the deck. This oil will cause drive belt slippage and other difficulties. Check for slippage and clean all parts inside the deck before operating after lubrication. Check for oil emission after operation and before returning deck to the customer.

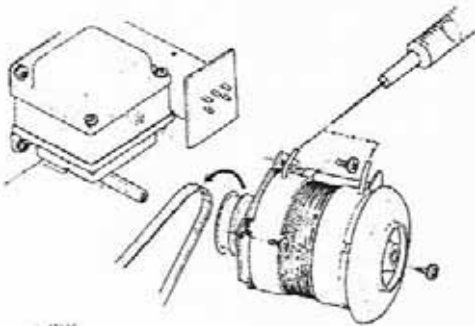

Fig. 9-1 Capstan Motor Oiling Point

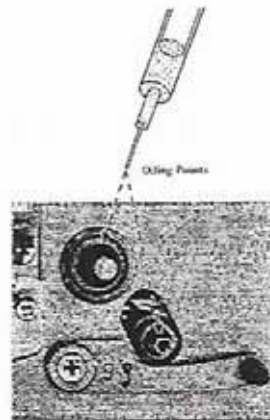

Fig. 9-2 Capstan Shaft and Pinch Roller Shaft Oiling Points

9-3 TEAC MAINTENANCE FLUIDS

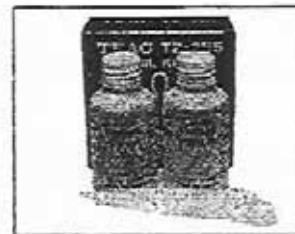

Fig. 9-3 TZ-255 Oil Kit



Fig. 9-3 TZ-261 Cleaner

9-4 DEMAGNETIZATION OF HEADS

If the record or Playback heads becomes magnetized, noise will increase and tonal fidelity will deteriorate. For this reason it is advisable to use non-magnetic tools when working near the heads. If the heads have had any contact with current or magnetized metal parts, demagnetize them with a TEAC E-3 eraser or Equivalent.

10. TROUBLE-SHOOTING

NOTE: The following guide lists specific difficulties that could occur in the A-3300SX or A-2300SX. Possible causes are listed for each malfunction. Visually inspect the unit for any damage such as broken or burned components or wiring, loose connections, etc.

Malfunction	Possible Source of Trouble	Corrective Procedure
Capstan fails to turn	Belt off or slipping, line fuse, safety switch (SW-2), speed select switch (SW-12), phase advance capacitor (C-5), rewind relay (K-3).	Repair or replace the defective components.
Pinch roller fails to contact capstan in play mode	Operation relay (K-1), Start relay (K-7), rewind relay (K-3), STOP micro-switch (S-4), PLAY (▶) micro-switch (S-7), capstan solenoid.	Refer to schematic diagram and repair or replace the defective components.
Right reel motor does not rotate in play mode.	Reel motor (right), brake solenoid, rewind relay (K-3), resistor (R-1)	Replace the defective components.
Left reel motor does not rotate in play mode.	Reel motor (left), brake solenoid, rewind relay (K-3), resistor (R-2)	Replace the defective components.
Both motors fail to operate.	Operating relay (K-1), start relay (K-7)	Replace the defective components.
Recorder does not operate in PLAY (▶)	Remote control jumper plug missing or loose, STOP micro-switch (S-4), brake solenoid, resistor (R-3), rewind relay (K-3), phase advance capacitor (C-5)	Normal DC resistance of the brake solenoid is 1.3K ohms. Refer to schematic diagram and repair or replace the defective components.
Playback noise or hum	Faulty connections, faulty playback head, faulty amplifier.	Repair or replace defective components.
Noise or hum during record	Magnetized head, faulty connections, MIC level set to maximum, faulty record amplifier, record relay (K-401)	Demagnetize and clean head, repair or replace defective components, check MIC VR.
Wow and flutter	Defective tape, dirty or defective pinch roller and pressure, oily or defective belt, reel motor tension.	Clean or replace defective components. Adjust motor tension.
Incorrect tape speed	Drive belt in wrong position. Incorrect pinch roller pressure.	Reposition drive belt. Adjust pinch roller pressure.
Brakes do not release	Defective brake solenoid	The D.C. resistance of the brake solenoid should be 1.6K ohms. Replace solenoid.
Fast forward or rewind mode inoperative	Rewind relay (K-3)	Refer to schematic diagram and repair or replace the defective components.
No record and/or erase	Record head dirty, erase head dirty, operate relay (K-1), record relay (K-401), REC micro-switch (S-8), record amplifier, bias OSC, record head, erase head.	Refer to schematic diagram and repair or replace the defective components.
No playback	Playback head defective or dirty, amplifier-to-deck connections, OUTPUT switch (SW-500), playback amplifiers	Refer to playback amplifier voltage chart.

11. SIMPLIFIED SCHEMATIC

— with level indications —

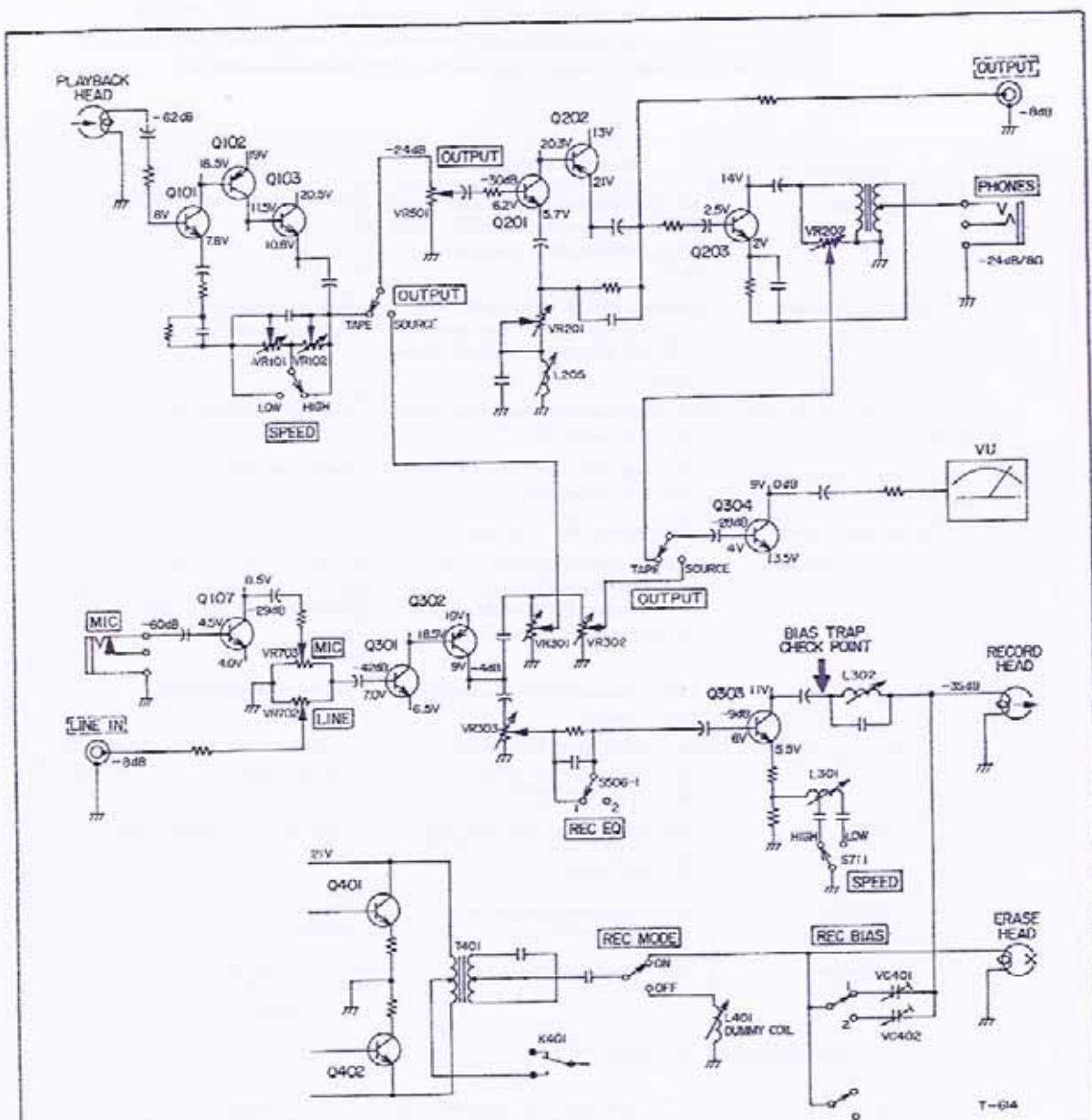

- NOTE: 1. Schematic shown for the LEFT channel only.
 2. Monitor switch shown in TAPE, SPEED SW in HIGH position.
 3. Circuit signal Level obtained with High input impedance AC VTVM. Reading in dB Referenced to 0 dB = 0.775V.
 4. Signal Level reading were obtained under the following conditions.
 Signal 400 Hz.
 MIC, Line control and Output controls at specified levels.

A-3300SX / A-2300SX Stereo Tape Deck

TEAC.

TEAC CORPORATION

3-7-3 NAKA-CHO MUSASHINO TOKYO PHONE (0422) 53-1111

TEAC CORPORATION OF AMERICA

7733 TELEGRAPH ROAD MONTEBELLO CALIFORNIA 90640 PHONE (213) 726-0303

TEAC AUSTRALIA PTY., LTD.

165-167 GLADSTONE STREET SOUTH MELBOURNE VICTORIA 3205 PHONE 699-6000

PRINTED IN JAPAN 1179 K05 030 0-2550E

TEAC®

PARTS LIST

For CANADA, EUROPE and U.K. models

A-3300SX A-2300SX

Stereo Tape Deck

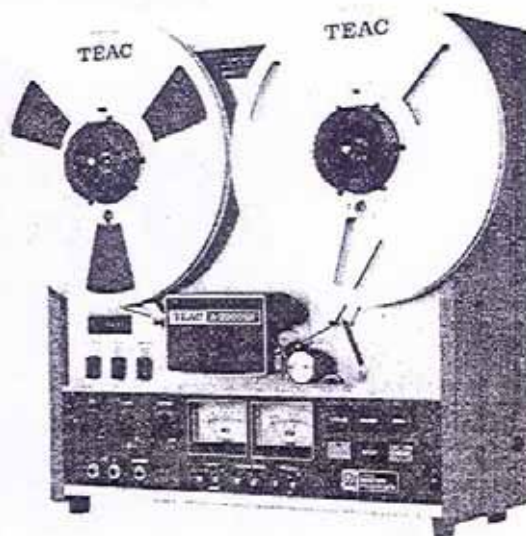

TABLE OF CONTENTS

1. EXPLODED VIEWS AND PARTS LIST SECTION

EXPLODED VIEW-1 (A-3300SX)	2, 3, 13
EXPLODED VIEW-2 (A-2300SX)	4, 5, 14
EXPLODED VIEW-3 (A-3300SX)	6, 7, 14
EXPLODED VIEW-4 (A-2300SX)	8, 9, 14
EXPLODED VIEW-5 (A-3300SX, A-2300SX)	10, 11
EXPLODED VIEW-6 (A-3300SX, A-2300SX)	12, 13

2. PC BOARD SECTION (Diagram and Parts List)

1. EQUALIZER, MIC AMPL. PC BOARD	15, 19
2. LINE, PHONE AMPL. PC BOARD	15, 19
3. RECORD, METER AMPL. PC BOARD	18, 20
4. BIAS OSCILLATOR PC BOARD	18, 21
5. CONTROL PC BOARD (A-3300SX)	17, 21
6. CONTROL PC BOARD (A-2300SX)	17, 22
7. SWITCH MOUNTING PC BOARD	18, 22
8. RECTIFIER PC BOARD	18, 22
9. CONTROL RELAY PC BOARD	18, 22
10. POWER SUPPLY PC BOARD	18, 23

INCLUDED ACCESSORIES	23
ASSEMBLING HARDWARE CODING LIST	24

PARTS ORDERING INFORMATION

Spare parts are available through your nearest TEAC Authorized Service Center or directly from the TEAC office, the address of which is written on the back cover. When ordering parts, always include the following information:

- | | |
|--------------|--------------------|
| 1. MODEL | 4. DESCRIPTION |
| 2. REF. NO. | 5. UNIT SERIAL NO. |
| 3. PARTS NO. | 6. MANUAL CODE NO. |

NOTICE REGARDING PARTS ORDERS

1. Do not order by REF. NO. only.
2. In some instances, individual minor parts are not available. In such a case, the entire assembly including the part requested will be sent to you.
3. Parts are identical between the different models with the exceptions as coded by the designations in the REMARKS column.
4. PC Boards shown viewed from foil side.
5. Parts marked with * require longer delivery time than regular parts.

REF. NO.	PARTS NO.	DESCRIPTION	REMARKS
2 - 1	55521280	Panel, Trim	
2 - 2	50112980	Grille Assy, Top	
2 - 3	*55523440	Panel, Top	
2 - 4	50161941	Protector, Reel	
2 - 5	50180432	Arm Assy, Tension	
2 - 6	50182701	Bushing, Arm; A	
2 - 7	50162980	Cover, Index Counter	
2 - 8	50123911	Cap, Guide Ring	
2 - 9	50123931	Ring, Guide	
2 - 10	50123921	Base, Guide Ring	
2 - 11	50142180	Cap, Pinch Roller	
2 - 12	50141751	Pinch Roller	
2 - 13	55447900	Cap, Dust; G (ø6)	
2 - 14	*50123900	Seal, Oil	
2 - 15	50136552	Head Housing	
2 - 16	55547360	Plate, Name	
2 - 17	*50134400	Plate, Head Base	
2 - 18	55201820	Spring, Head; D	
2 - 19	50220500	Spring, Head; B	
2 - 20	*50134371	Plate, Head	
2 - 21	55692030	Head, Playback	
2 - 22	*50133891	Head Shield; A	
2 - 23	55692020	Head, Record	
2 - 24	50663080	Head, Erase	
2 - 25	50136540	Spacer, Erase Head	
2 - 26	50136690	Bracket, Head Protector	
2 - 27	*50484211	PCB, HEAD	
2 - 28	*50182672	Pin, Guide	
2 - 29	*55531001	Plate, Housing Base	
2 - 30	50182730	Limiter, Right	
2 - 31	51300010	Switch, Micro	
2 - 32	50529050	Spark Killer, 0.01 mfd + 120 ohm 400V	
2 - 33	50276920	Nut, M9	
2 - 34	*50183932	Plate, Insulator	
2 - 35	55203110	Spring, Tension Arm	
2 - 36	*50183921	Drum, Tension Arm	
2 - 37	*55542870	Plate, VU Meter Support	
2 - 38	*50331440	Plate, Top Panel	
2 - 39	50253890	Button, Switch	CANADA
2 - 40	50443902	Switch Assy	CANADA
2 - 41	*50237470	Bracket, Switch Assy	CANADA
2 - 42	50253530	Button	EUROPE, U.K.
2 - 43	55340140	Button	EUROPE, U.K.
2 - 44	55501280	Mask, Switch	EUROPE, U.K.
2 - 45	55501530	Mask, Switch; B	EUROPE, U.K.
2 - 46	55551530	Bracket Switch	EUROPE, U.K.
2 - 47	51340450	Switch, Push	EUROPE, U.K.
2 - 48	51340440	Switch, Power	EUROPE, U.K.
2 - 49	55501540	Paper, Insulating	EUROPE, U.K.
2 - 50	50221110	Spring, B	EUROPE, U.K.
2 - 51	50182750	Limiter, Tension	
2 - 52	50276990	Collar, Rubber	
2 - 53	*50332541	Angle, PCB	
2 - 54	*51685511	PCB Assy, RECTIFIER	
2 - 55	50277110	Washer, Trim	
2 - 56	50112713	Frame, Side	
2 - 57	*50330111	Bracket, Resistor Mounting	
2 - 58	*51815810	Resistor, Non Flammable; 1 k ohm 30G	
2 - 59	*51815790	Resistor, Non Flammable; 150 ohm 20A1G	
2 - 60	*51815800	Resistor, Non Flammable; 700 ohm 20ATG	
2 - 61	55430060	Board, Side	
2 - 62	55044110	Screw Assy, Side Board	
2 - 63	*50235312	Angle, Rear Cover	

(Continued on page 14.)

REF. NO.	PARTS NO.	DESCRIPTION	REMARKS
2- 1	55521280	Panel, Trim	
2- 2	50112980	Grille Assy, Top	
2- 3	*55523440	Panel, Top	
2- 4	50161941	Protector, Reel	
2- 5	50180432	Arm Assy, Tension	
2- 6	50182701	Bushing, Arm; A	
2- 7	50162980	Cover, Index Counter	
2- 8	50123911	Cap, Guide Ring	
2- 9	50123931	Ring, Guide	
2-10	50123921	Base, Guide Ring	
2-11	50142180	Cap, Pinch Roller	
2-12	50141751	Pinch Roller	
2-13	55447900	Cap, Dust; G (p6)	
2-14	*50123900	Seal, Oil	
2-15	50136552	Head Housing	
2-16	55547360	Plate, Name	
2-17	*50134400	Plate, Head Base	
2-18	55201820	Spring, Head; D	
2-19	50220600	Spring, Head; B	
2-20	*50134371	Plate, Head	
2-21	55692030	Head, Playback	
2-22	*50133891	Head Shield; A	
2-23	55692020	Head, Record	
2-24	50663090	Head, Erase	
2-25	50136540	Spacer, Erase Head	
2-26	50136690	Bracket, Head Protector	
2-27	*50484211	PCB, HEAD	
2-28	*50182672	Pin, Guide	
2-29	*55531001	Plate, Housing Base	
2-30	50182730	Limiter, Right	
2-31	51300010	Switch, Micro	
2-32	50529050	Spark Killer, 0.01 mfd + 120 ohm 400V	
2-33	50276920	Nut, M9	
2-34	*50183932	Plate, Insulator	
2-35	55203110	Spring, Tension Arm	
2-36	*50183921	Drum, Tension Arm	
2-37	*55542870	Plate, VU Meter Support	
2-38	*50331440	Plate, Top Panel	
2-39	50253890	Button, Switch	
2-40	50443902	Switch Assy	
2-41	*50237470	Bracket, Switch Assy	
2-42	50253530	Button	
2-43	55340140	Button	
2-44	55501280	Mask, Switch	
2-45	55501530	Mask, Switch; B	
2-46	55551530	Bracket, Switch	
2-47	51340450	Switch, Push	
2-48	51340440	Switch, Power	
2-49	55501540	Paper, Insulating	
2-50	50221110	Spring, B	
2-51	50182750	Limiter, Tension	
2-52	50276990	Collar, Rubber	
2-53	*50332541	Angle, PCB	
2-54	*51685511	PCB Assy, RECTIFIER	
2-55	50277110	Washer, Trim	
2-56	50112713	Frame, Side	
2-57	*50330111	Bracket, Resistor Mounting	
2-58	*51815810	Resistor, Non Flammable; 1 k ohm 30G	
2-59	*51815790	Resistor, Non Flammable; 150 ohm 20A1G	
2-60	*51815800	Resistor, Non Flammable; 700 ohm 20ATG	
2-61	55430060	Board, Side	
2-62	55044110	Screw Assy, Side Board	
2-63	*50235312	Angle, Rear Cover	

CANADA
CANADA
CANADA
EUROPE, U.K.
EUROPE, U.K.
EUROPE, U.K.
EUROPE, U.K.
EUROPE, U.K.
EUROPE, U.K.
EUROPE, U.K.

(Continued on page 14.)

REF. NO.	PARTS NO.	DESCRIPTION	REMARKS
3- 1	50173571	Drum, Brake	
3- 2	*55552720	Retainer, Brake	
3- 3	*50173490	Spacer, Brake Retainer	
3- 4	50173333	Band Assy, Brake; L	
3- 5	50173612	Band Assy, Brake; R	
3- 6	55552740	Felt, Brake	
3- 7	*50173601	Plate, Brake Band Assy; P	
3- 8	50616770	Solenoid, Brake	
3- 9	50422570	Diode, S1B01-06 (D21, D22)	2T
3-10	71041071	Motor, Reel	
3-11	50446180	Switch, Micro (S10, S11)	
3-12	50332680	Plate, Insulating	
3-13	*50173640	Bracket, Micro Switch	
3-14	50549920	Capacitor, Mylar; 0.1 mfd 400V AC	
3-15	*51260310	Terminal Assy, 5P	EUROPE, U.K.
3-16	*55501550	Sheet, Insulating	EUROPE, U.K.
3-17	*55551550	Bracket, Terminal Assy	EUROPE, U.K.
3-18	51815900	Resistor, Non Flammable; 600 ohm 40G	
3-19	51815970	Resistor, Non Flammable; 250 ohm 30A1G	
3-20	51815960	Resistor, Non Flammable; 150 ohm 30A1G	
3-21	51815940	Resistor, Non Flammable; 100 ohm 30A1G	
3-22	*55551560	Bracket, Resistor	
3-23	50484193	PCB, MP	
3-24	51714600	Capacitor, MP; 7 mfd x 2	CANADA
	51700050	Capacitor, MP; (7 + 1.5) mfd x 2	EUROPE, U.K.
3-25	*51521450	Transformer, Power	CANADA
	*51521230	Transformer, Power	EUROPE, U.K.
3-26	*55045040	Bracket Assy, Transformer	
3-27	50491593	PCB Assy, CONTROL RELAY	CANADA
	50491601	PCB Assy, CONTROL RELAY	EUROPE, U.K.
3-28	*50237020	Bracket, PCB	Part of 3-27
3-29	*55021772	Chassis, Reel Motor; D	
3-30	*50161950	Stay, Reel Motor	
3-31	50332530	Belt, Counter	
3-32	*50332521	Bracket, Counter	
3-33	50585140	Counter, Index	
3-34	50123984	Fan, Motor Cooling	
3-35	50701341	Motor, Capstan	
3-36	*50237520	Plate, Capstan Motor Mounting	
3-37	50124003	Pulley, Motor (50Hz/60Hz)	
3-38	*50706211	Cushion, Rubber	
3-39	*50332790	Spacer, Rubber Cushion	
3-40	*50123850	Stay, Capstan Motor	
3-41	50491401	PCB Assy, Terminal	CANADA
	51685980	PCB Assy, Terminal	EUROPE, U.K.
3-42	50545650	Capacitor, MP; (2 + 0.8) mfd 250V	
3-43	55340410	Clamp, Wire; A	
3-44	*50123860	Stay, Thrust	
3-45	50277233	Plate, Thrust	
3-46	*50277151	Angle, Thrust	
3-47	50123802	Flywheel, Capstan	
3-48	50125340	Belt, Capstan	2T
	50123830	Belt, Capstan	4T
3-49	*50142190	Plate, Arm Support	
3-50	50120451	Capstan Assy, 38 cm/s	2T
	50120441	Capstan Assy, 19 cm/s	4T
3-51	50140237	Arm Assy, Pinch Roller	
3-52	*50221152	Spring, Pressure	
3-53	50616760	Solenoid, Pinch Roller	
3-54	*50141821	Pivot, Roller Arm	
3-55	50275690	Cushion, Rubber	
3-56	*55551910	Limitter, Pinch Roller	
3-57	50220441	Spring	

(Continued on page 14.)

REF. NO.	PARTS NO.	DESCRIPTION	REMARKS
4 - 1	50173561	Drum, Brake	
4 - 2	50173661	Band Assy, Brake; C	
4 - 3	55043100	Band Assy, Brake; F	
4 - 4	55344750	Felt, Brake	
4 - 5	*50170150	Plate, Band Pressure	
4 - 6	*50170160	Angle, Band Mounting	
4 - 7	*50173650	Plate, Brake Band Assy	
4 - 8	*50172550	Retainer, Brake	
4 - 9	71041043	Motor, Reel	
4 - 10	50616770	Solenoid, Brake	
4 - 11	*50173690	Plate, Micro Switch	
4 - 12	*50332680	Plate, Insulating	
4 - 13	50446180	Switch, Micro	
4 - 14	50549920	Capacitor, Meta. Mylar; 0.1 mfd 400V	
4 - 15	*55045030	Bracket Assy, Transformer	
4 - 16	*51521420	Transformer, Power	CANADA
	*51521200	Transformer, Power	EUROPE, U.K.
4 - 17	50491583	PCB Assy, CONTROL RELAY	CANADA
	50491681	PCB Assy, CONTROL RELAY	EUROPE, U.K.
4 - 18	*50332573	Bracket, PCB	
4 - 19	50545960	Capacitor, MP; 3.9 mfd	CANADA
	50545940	Capacitor, MP; (3.9 + 0.9) mfd	EUROPE, U.K.
4 - 20		(Not used)	
4 - 21	*50162960	Cushion, Rubber; B	
4 - 22	*50237462	Chassis, Reel Motor; S	
4 - 23	*50161950	Stay, Reel Motor	
4 - 24	*55552130	Plate, Motor Spéc	
4 - 25	50160334	Reel Table Assy	
4 - 26	50332560	Belt, Counter	
4 - 27	*50332521	Bracket, Counter	
4 - 28	50585140	Counter, Index	
4 - 29	50123984	Fan, Motor Cooling	
4 - 30	50701341	Motor, Capstan	
4 - 31	50124003	Pulley, Motor (50Hz/60Hz)	
4 - 32	*50237520	Plate, Capstan Motor Mounting	
4 - 33	*50491401	PCB Assy, TERMINAL	CANADA
	*51685980	PCB Assy, TERMINAL	EUROPE, U.K.
4 - 34	50545650	Capacitor, MP; (2 +0.8) mfd 250V	
4 - 35	*50123850	Stay, Capstan Motor	
4 - 36	*50706211	Cushion, Rubber	
4 - 37	*50332790	Spacer, Rubber Cushion	
4 - 38	*50277151	Angle, Thrust	
4 - 39	50123802	Flywheel, Capstan	
4 - 40	50123830	Belt, Capstan	
4 - 41	50277233	Plate, Thrust	
4 - 42	*50123860	Stay, Thrust	
4 - 43	55340410	Clamp, Wire; A	
4 - 44	50120441	Capstan Assy	
4 - 45	*50142180	Plate, Arm Support	
4 - 46	*50221152	Spring, Pressure	
4 - 47	50140237	Arm Assy, Pinch Roller	
4 - 48	*50141821	Pivot, Roller Arm	
4 - 49	50816760	Solenoid, Pinch Roller	
4 - 50	50422570	Diode, S1801-06	
4 - 51	50275690	Cushion, Rubber	
4 - 52	*55551910	Limiters, Pinch Roller	
4 - 53	50220441	Spring	
4 - 54	*50152453	Plate, Lifter	
4 - 55	50150242	Arm Assy, Lifter; A	
4 - 56	50150252	Arm Assy, Lifter; B	
4 - 57	*50152501	Pivot, Lifter Arm	
4 - 58	50221100	Spring, A	
4 - 59	*51260310	Terminal Assy, 5P	EUROPE, U.K.

(Continued on page 14.)

REF. NO.	PARTS NO.	DESCRIPTION	REMARKS
5-1	55021120	Panel, Ampl.; Trim	
5-2	55521263	Panel, Ampl.	
5-3	55301340	Escutcheon, VU Meter	
5-4	50253750	Knob, Upper	
5-5	55040591	Knob, Lower	
5-6	*55542650	Spacer, Escutcheon	
5-7	50332650	Washer, Insulating	
5-8	50237300	Protector, Rubber: P	
5-9	50237201	Button, A	
5-10	50237211	Button, B	
5-11	50237262	Button Assy, PAUSE	
5-12	50237221	Button, STOP	
5-13	50237233	Button Assy, REC	
5-14	*55340430	Hinge, A	
5-15	*55340440	Hinge, B	
5-16	*50237291	Plate Nut, PCB	
5-17	*55505210	Plate Nut	
5-18	*55505200	Bracket, Hinge; S	
5-19	50237490	Cushion, Lamp	
5-20	50414630	Lamp, Subminiature	
5-21	*50331430	Shaft, Panel Attaching	
5-22	51501461	Var. Res., 100 k ohm - A x 2	
5-23	51501471	Var. Res., 10 k ohm - A x 2	
5-24	50432450	Jack, Phone; 3 cond.	
5-25	50430240	Jack, Phone; Single	
5-26	50572980	Resistor, Carbon; 4.7 k ohm 1/2W	
5-27	*51650280	Meter, VU	
5-28	*55530400	Bracket, Meter	
5-29	*55520543	Bracket, Switch	
5-30	*55542661	Mask, Lever Switch	
5-31	51683310	PCB Assy, SWITCH MOUNTING	
5-32	*55530391	Angle Bottom	
5-33	*55556050	Plate, Shield; A	
5-34	55540530	Plate, Name; 2 Track Master Recorder	A-33005X 2T
5-35	50490896	PCB Assy, CONTROL	A-33005X
	51680655	PCB Assy, CONTROL	A-23005X
5-36	50237131	Bracket, Switch; Left	
5-37	50237141	Bracket, Switch; Right	
5-38	50237121	Plate	
5-39	50446580	Switch, Micro	
5-40	50446570	Switch, Micro	
5-41	50446560	Switch, Micro	

EXPLODED VIEW-6 (A-3300SX,A-2300SX)

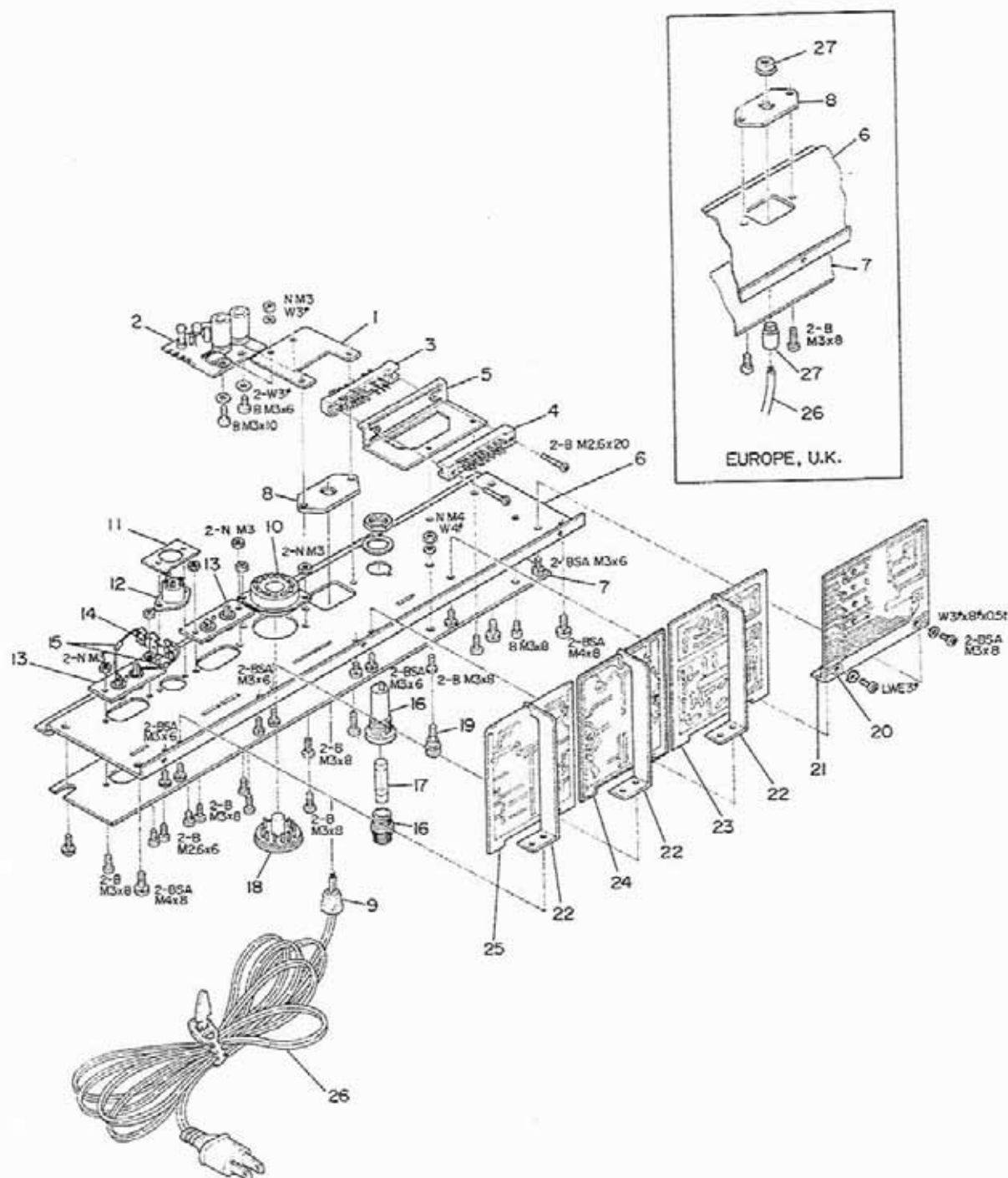

REF. NO.	PARTS NO.	DESCRIPTION	REMARKS
6-1	50237020	Bracket, PCB	
6-2	51685501	PCB Assy, POWER SUPPLY	
6-3	50436530	Connector, Plug; 15P	
6-4	50438310	Connector, Socket; 15P	
6-5	50237450	Bracket, Connector	
6-6	50237401	Chassis, Ampl.	CANADA
	55520161	Chassis, Ampl.: E	EUROPE, U.K.
6-7	50237411	Panel, Rear Trim	CANADA
	55522370	Panel, Rear Trim	EUROPE, U.K.
6-8	*55541540	Holder, Strain Relief	
6-9	55300470	Strain Relief, AC Power Cord	CANADA
6-10	50432700	Socket, 11P	
6-11	50233530	Plate, DIN Connector	
6-12	50430010	Connector, DIN	
6-13	50434632	Jack, Pin; 2P	
6-14	50452060	Terminal Strip, 1L-2P	
6-15	50573300	Resistor, Carbon; 100 k ohm 1/4W	R501, R502
6-16	50412280	Holder, Fuse	CANADA
6-17	51421150	Fuse, 5A-250V	CANADA
6-18	50433011	Plug, Dummy; 11P	
6-19	50454071	Post, GND	CANADA
6-20	50490874	PCB Assy, BIAS OSCILLATOR	
6-21	50332550	Angle, PCB	
6-22	50233760	Bracket, PCB	
6-23	51683970	PCB Assy, RECORD/METER AMPL.	A-3300SX 2T
	51683980	PCB Assy, RECORD/METER AMPL.	All except A-3300SX 2T
6-24	51686650	PCB Assy, LINE/PHONE AMPL.	
6-25	51686740	PCB Assy, PLAYBACK EQ/MIC AMPL.	A-3300SX 2T
	51686721	PCB Assy, PLAYBACK EQ/MIC AMPL.	A-3300SX
	51686631	PCB Assy, PLAYBACK EQ/MIC AMPL.	A-2300SX
6-26	51280760	Cord, AC Power	CANADA
	51280180	Cord, AC Power	EUROPE
	51280470	Cord, AC Power	U.K.
6-27	*55300540	Strain Relief, AC Power Cord	EUROPE, U.K.

(Continued from page 3.)

REF. NO.	PARTS NO.	DESCRIPTION	REMARKS
1-55	*50112713	Frame, Side	
1-56	*50113412	Panel, Side: Left	
1-57	*55041710	Panel Assy, Side: Right	
1-58	55430060	Board, Side: B	
1-59	55430070	Board, Side: A	
1-60	55810370	Screw, Guide	
1-61	55044110	Screw Assy, Side Board	
1-62	50277110	Washer, Trim	
1-63	50277960	Leg, Case	
1-64	*55043351	Cover Assy, Bottom	
1-65	*50235312	Angle, Rear Cover	
1-66	*55509170	Cover, Rear	CANADA
	*55530320	Cover, Rear	EUROPE, U.K.
1-67	*51686420	PCB Assy, FUSE	CANADA
	*51686141	PCB Assy, FUSE	EUROPE, U.K.
	*51676420	PCB, FUSE	CANADA
	*51676141	PCB, FUSE	EUROPE, U.K.
	*50412370	Holder, Fuse (14 used)	CANADA
	*51420870	Holder, Fuse (14 used)	EUROPE, U.K.
	*50411440	Fuse, 2A-250V; F1	CANADA
	*50411450	Fuse, 1A-250V; F2 - F4	CANADA
	*51421130	Fuse, 1.6A-250V; F5	CANADA
	*51471140	Fuse, 2.5A-250V; F6, F7	CANADA
	*50411550	Fuse, 2A-250V; F1	EUROPE, U.K.
	*50411410	Fuse, 1A-250V; F2 ~ F4	EUROPE, U.K.
	*50411400	Fuse, 1AT-250V; F5	EUROPE, U.K.
	*51421890	Fuse, 1.6AT-250V; F6, F7	EUROPE, U.K.

(Continued from page 5.)

REF. NO.	PARTS NO.	DESCRIPTION	REMARKS
2-64	50277980	Leg, Case	
2-65	*55043351	Cover, Bottom	
2-66	*55530310	Cover, Rear	
2-67	55043411	Lever Assy, Cue	
2-68	55501511	Spacer, Head: A	

(Continued from page 7.)

REF. NO.	PARTS NO.	DESCRIPTION	REMARKS
3-58	*50152453	Plate, Lifter	
3-59	50221100	Spring, A	
3-60	50150252	Arm Assy, Lifter: B	
3-61	*50152501	Pivot, Lifter Arm	
3-62	50150242	Arm Assy, Lifter: A	
3-63	*55552130	Plate, Motor Space	
3-64	*55552140	Stay, Motor Space Plate	

(Continued from page 9.)

REF. NO.	PARTS NO.	DESCRIPTION	REMARKS
4-60	*55501550	Sheet, Insulating	EUROPE, U.K.
4-61	*55551550	Bracket, Terminal Assy	EUROPE, U.K.
4-62	*55551611	Bracket, FUSE PCB	
4-63	*51685870	PCB Assy, FUSE	CANADA
	*51686440	PCB Assy, FUSE	EUROPE, U.K.
	*51675870	PCB, FUSE	CANADA
	*51676440	PCB, FUSE	EUROPE, U.K.
	*50412370	Holder, Fuse (14 used)	CANADA
	*51420870	Holder, Fuse (14 used)	EUROPE, U.K.
	*50411450	Fuse, 1A-250V; F1 ~ F4	CANADA
	*51421130	Fuse, 1.6A-250V; F5	CANADA
	*51421140	Fuse, 2.5A-250V; F6, F7	CANADA
	*50411410	Fuse, 1A-250V; F1 ~ F4	EUROPE, U.K.
	*50411400	Fuse, 1A-250V; F5	EUROPE, U.K.
	*51421880	Fuse, 1.6A-250V; F6, F7	EUROPE, U.K.

2. PC BOARD SECTION (Diagram)

2-1. EQUALIZER, MIC AMPL. PC BOARD

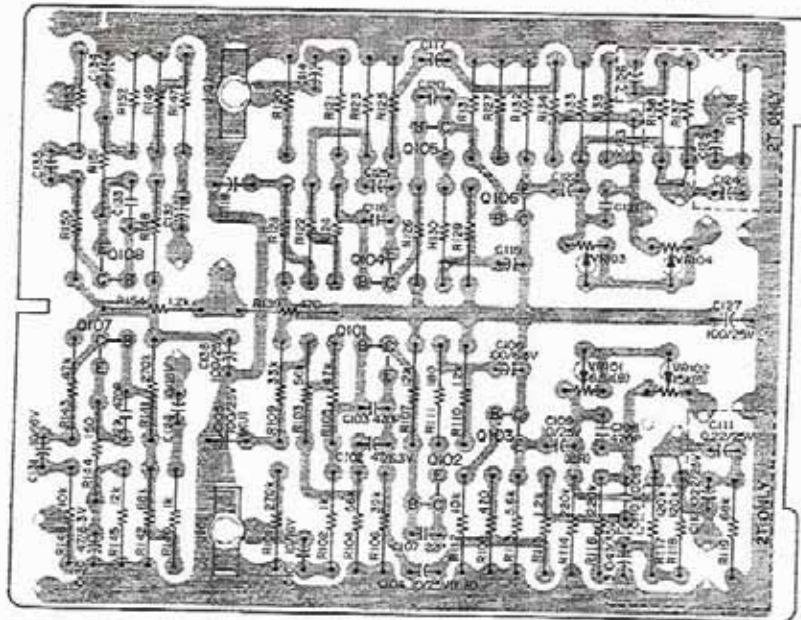

P-245-1

2-2. LINE, PHONE AMPL. PC BOARD

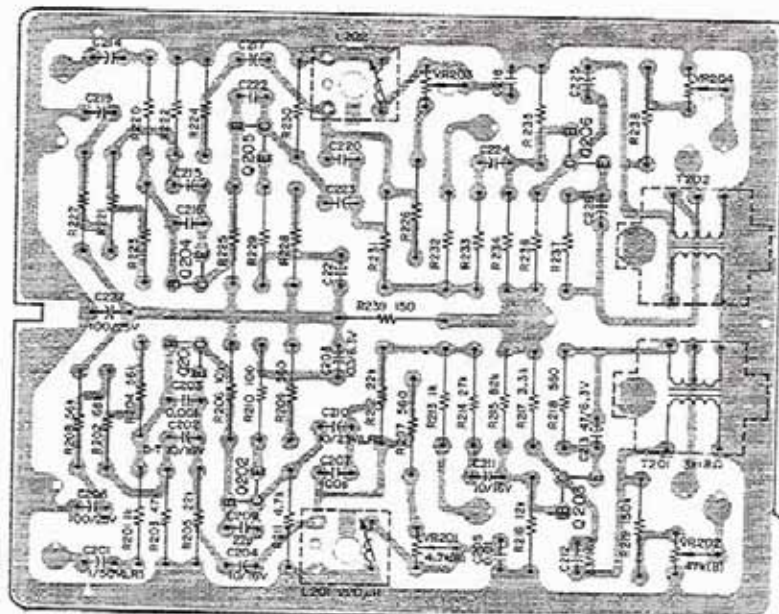

P-246-1

2-7. SWITCH MOUNTING PC BOARD

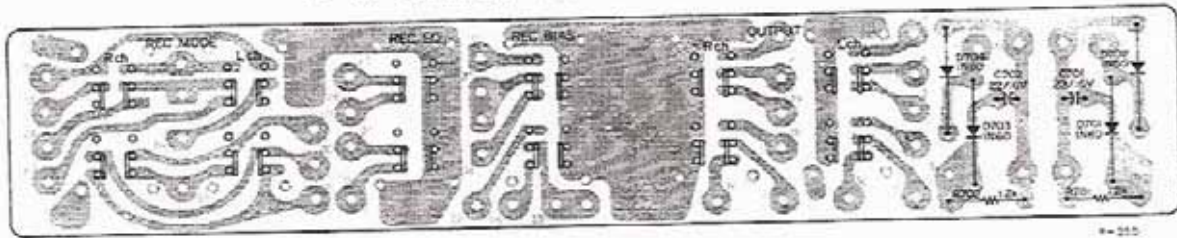

2-8. RECTIFIER PC BOARD

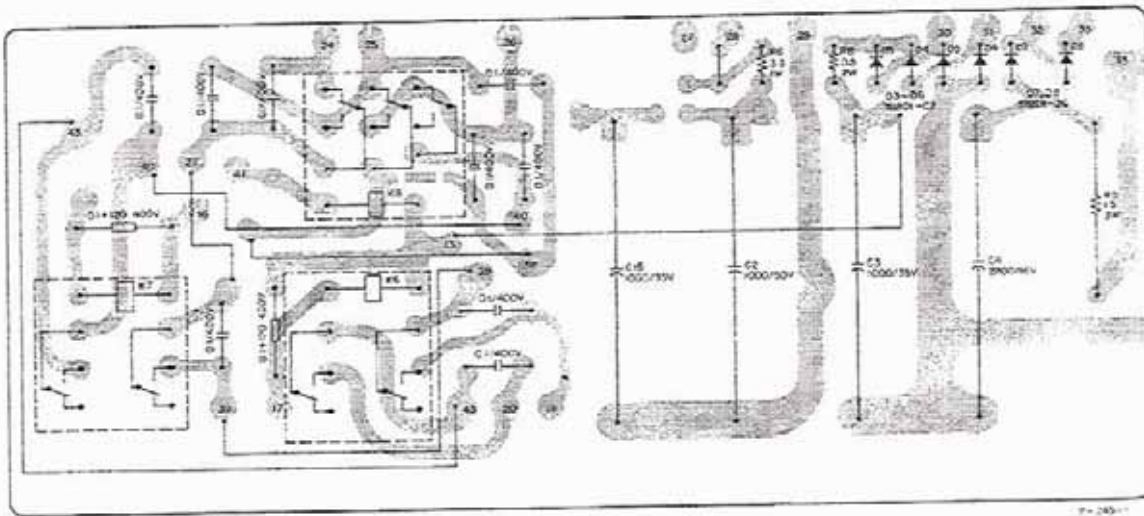

2-9. CONTROL RELAY PC BOARD

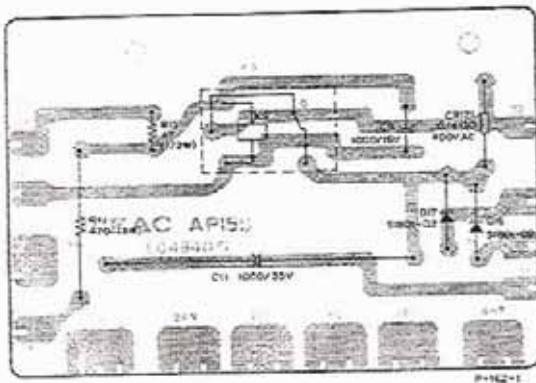

2-10. POWER SUPPLY PC BOARD

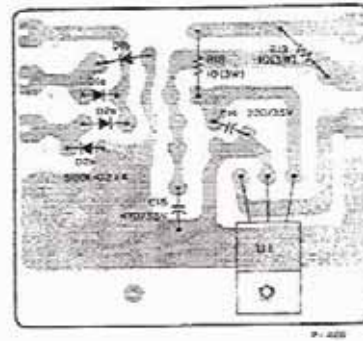

2. PC BOARD SECTION (Parts List)

2-1. EQUALIZER, MIC AMPL. PC BOARD

REF. NO.	PARTS NO.	DESCRIPTION
	51686721	PCB Assy (A-3300SX)
	51686740	PCB Assy (A-3300SX 2T)
	51686641	PCB Assy (A-2300SX)

51676640 PC Board

TRANSISTORS

Q101/Q104	50424710	2SC1345 (E) or 50424340 2SC1000 (BL)
Q102/Q105	51450380	2SA750 (E) or 50423650 2SA494 (Y)
Q103/Q106	50424860	2SC536 (G) or 50424800 2SC828 (S)
Q107/Q108	50424710	2SC1345 (E) or 50424340 2SC1000 (BL)

RESISTORS

All resistors are rated $\pm 5\%$ tolerance, $\frac{1}{4}$ watt and of carbon type unless otherwise noted.

R101/R120	50573400	270 k ohm
R102/R121	50572820	1 k ohm
R103/R122	50573241	56 k ohm SG
R104/R123	50573241	56 k ohm SG
R105/R124	50573220	47 k ohm
R106/R125	50573201	39 k ohm SG
R107/R126	50573061	12 k ohm SG
R108/R127	50572740	470 ohm (A-3300SX)
	50572760	560 ohm (A3300SX 2T)
	50572700	330 ohm (A-2300SX)
R109/R128	50573180	33 k ohm
R110/R129	50572840	1.2 k ohm
R111/R130	50572640	180 ohm
R112/R131	50573060	10 k ohm
R113/R132	50573000	5.6 k ohm
R114/R133	50573380	220 k ohm
R115/R134	50572840	1.2 k ohm
R116/R135	50573380	220 k ohm
	50573460	470 k ohm (2T)
R117/R136	50573320	120 k ohm (2T)
R118/R137	50573320	120 k ohm (2T)
R119/R138	50573260	68 k ohm (2T)
R139	51818640	470 ohm Non Flammable
R140/R147	50572820	1 k ohm
R141/R148	50573400	270 k ohm
R142/R149	50573260	68 k ohm
R143/R150	50573220	47 k ohm
R144/R151	50572620	150 ohm
R145/R152	50573080	12 k ohm
R146/R153	50572060	10 k ohm
R154	50572840	1.2 k ohm

REF. NO. PARTS NO. DESCRIPTION

CAPACITORS

C101/C114	51700080	Tant.	10 mfd	16V
C102/C115	50554030	Elec.	47 mfd	6.3V
C103/C116	50547560	Dip. Mica	470 pfd	50V
C104/C117	51700820	Elec.	10 mfd	25V LR
C105/C118	50549740	Elec.	100 mfd	25V KU
C106/C119	50554230	Elec.	100 mfd	6.3V
C107/C120	50543820	Dip. Mica	22 pfd	50V
C108/C121	50547560	Dip. Mica	470 pfd	50V
C109/C122	51700820	Elec.	10 mfd	25V LR
C110/C123	50548420	Mylar	0.015 mfd	50V
C111/C124	50546661	Dip. Tant.	0.22 mfd	35V (2T)
C112/C125	50546661	Dip. Tant.	0.22 mfd	35V (2T)
C113/C126	50548681	Dip. Tant.	0.47 mfd	35V (2T)
C127	50554170	Elec.	100 mfd	25V
C128/C132	50554050	Elec.	10 mfd	16V
C129/C133	50547560	Dip. Mica	470 pfd	50V
C130/C134	50554030	Elec.	47 mfd	6.3V
C131/C135	50554050	Elec.	10 mfd	16V
C136	50554170	Elec.	100 mfd	25V

VARIABLE RESISTORS

VR101/VR103	50533580	Semi-fixed, 6.8 k ohm - B
VR102/VR104	50533540	Semi-fixed, 15 k ohm - B
	50533580	Semi-fixed, 6.8 k ohm - B (2T)

MISCELLANEOUS

J101/J102	50435000	Jack, Pin (2T)
-----------	----------	----------------

2-2. LINE, PHONE AMPL. PC BOARD

REF. NO. PARTS NO. DESCRIPTION

51686650 PCB Assy

51676650 PCB

TRANSISTORS

Q201/Q204	50424940	2SC900 (E) or 50423870 2SC693 (G)
Q202/Q205	51450380	2SA750 (E) or 50424660 2SA564 (R)
Q203/Q206	50424860	2SC536 (G) or 50423830 2SC536 (F)

2-3. RECORD, METER AMPL. PC BOARD

REF. NO.	PARTS NO.	DESCRIPTION
----------	-----------	-------------

RESISTORS

All resistors are rated ±5% tolerance, ¼ watt and of carbon type unless otherwise noted.

R201/R220	50572800	1 k ohm
R202/R221	50573260	68 k ohm
R203/R222	50573220	47 k ohm
R204/R223	50573240	56 k ohm
R205/R224	50573140	22 k ohm
R206/R225	50573060	10 k ohm
R207/R226	50572760	560 ohm
R208/R227	50573240	56 k ohm
R209/R228	50572760	560 ohm
R210/R229	50572580	100 ohm
R211/R230	50572080	4.7 k ohm
R212/R231	50573140	22 k ohm
R213/R232	50572800	1 k ohm
R214/R233	50573160	27 k ohm
R215/R234	50573280	82 k ohm
R216/R235	50573080	12 k ohm
R217/R236	50572940	3.3 k ohm
R218/R237	50572760	560 ohm
R219/R238	50573340	150 k ohm
R239	51818520	150 ohm Non Flammable

CAPACITORS

C201/C214	51700880	Elec.	1 mfd	50V LR
C202/C215	50546562	Dip. Tent.	10 mfd	16V
C203/C216	50548320	Mylar	0.001 mfd	50V
C204/C217	50554050	Elec.	10 mfd	16V
C205/C218	50548020	Mylar	0.01 mfd	50V
C206/C219	50554170	Elec.	100 mfd	25V
C207/C220	50547440	Dip. Mica	100 pfd	50V
C208/C221	50554230	Elec.	100 mfd	6.3V
C209/C222	50543820	Dip. Mica	22 pfd	50V
C210/C223	51700820	Elec.	10 mfd	25V LR
C211/C224	50554050	Elec.	10 mfd	16V
C212/C225	50554260	Elec.	33 mfd	16V
C213/C226	50554030	Elec.	47 mfd	6.3V
C227	50554170	Elec.	100 mfd	25V

VARIABLE RESISTORS

VR201/VR203	50533460	Semi-fixed, 4.7 k ohm - B
VR202/VR204	50533520	Semi-fixed, 47 k ohm - B

COILS/TRANSFORMERS

L201/L202	50566640	Coll, choke 220 µH
T201/T202	50563410	Transformer, Output or
	50562141	Transformer, Output

REF. NO.	PARTS NO.	DESCRIPTION
----------	-----------	-------------

51683970	PCB Assy (2T)
51683980	PCB Assy

50484103	PCB
----------	-----

TRANSISTORS

Q301/Q305	50424940	2SC900 (E) or
	50423870	2SC693 (G)
Q302/Q306	51450380	2SA750 (E) or
	50423650	2SA484 (Y)
Q303/Q307	51450380	2SC945L (K) or
	50424600	2SC828 (S)
Q304/Q308	51450380	2SC945L (K) or
	50424600	2SC828 (S)

CARBON RESISTORS

All resistors are rated ±5% tolerance and ¼ watt.

R301/R329	50570820	1 k ohm
R302/R330	50571400	270 k ohm
R303/R331	50571360	180 k ohm
R304/R332	50571200	39 k ohm
R305/R333	50571080	12 k ohm
R306/R334	50570700	330 ohm
R307	50571100	15 k ohm
R308/R335	50571220	47 k ohm
R309/R336	50571300	100 k ohm
R310/R337	50570720	390 ohm
R311/R338	50570540	68 ohm
R312/R339	50570940	3.3 k ohm
R313/R340	50571360	180 k ohm
R314/R341	50571320	120 k ohm
R315/R342	50571020	6.8 k ohm
R316/R343	50570980	4.7 k ohm
R317/R344	50571220	47 k ohm
R318/R345	50571140	22 k ohm
R319/R346	50570900	2.2 k ohm
R320/R347	50570500	47 ohm
R321/R348	50570840	1.2 k ohm
R322/R349	50570810	150 ohm
	50570560	82 ohm (2T)
R323/R350	50571280	68 k ohm
R324/R351	50571100	15 k ohm
R325/R352	50570960	3.9 k ohm
R326/R353	50570820	1 k ohm
R327/R354	50570520	56 ohm
R328	50570540	68 ohm

CAPACITORS

C301/C320	50554040	Elec.	10 mfd	25V
C302/C321	50548320	Mylar	0.001 mfd	50V
C303/C322	50554570	Elec.	100 mfd	10V
C304	50554170	Elec.	100 mfd	25V
C305/C324	50548270	Mylar	0.047 mfd	50V
	50548370	Mylar	0.082 mfd	50V (2T)
C307/C325	50543820	Dip. Mica	22 pfd	50V
C308/C326	50554910	Elec.	220 mfd	10V

REF. NO.	PARTS NO.	DESCRIPTION
C309/C327	51700820	Elec. 10 mfd 25V LR
C310/C328	50548330	Mylar 0.027 mfd 50V
	50548240	Mylar 0.033 mfd 50V (2T)
C311/C329	50554040	Elec. 10 mfd 25V
C312/C330	50546621	Dip. Tant. 6.8 mfd 25V
C313/C331	50543440	Polyst. 820 pfd 50V
C314/C332	50548420	Mylar 0.015 mfd 50V
	50548300	Mylar 0.0033 mfd 50V (2T)
C315/C333	50548330	Mylar 0.027 mfd 50V
	50548420	Mylar 0.015 mfd 90V (2T)
C316/C334	50554670	Elec. 1 mfd 25V
C317/C335	50554220	Elec. 3.3 mfd 25V
C318/C336	50554230	Elec. 100 mfd 6.3V
C319/C337	50548120	Mylar 0.0015 mfd 50V
C350/C351	50547420	Dip Mics 47pfd 50V
C338	50554180	Elec. 220 mfd 25V
C501/C502	50548130	Mylar 0.0047 mfd 50V

VARIABLE RESISTORS

VR301/VR304	50533960	Semi-fixed, 33 k ohm - B
VR302/VR305	50533490	Semi-fixed, 100 k ohm - B
VR303/VR306	50533960	Semi-fixed, 33 k ohm - B

COILS

L301/L303	50566370	Record EQ, 2.4-4.2 mH
	50566670	Record EQ, 1.5-2.4 mH (2T)
L302/L304	50566590	Trap, 3 mH or
	50566300	Trap, 3 mH

2-4. BIAS OSCILLATOR PC BOARD

REF. NO.	PARTS NO.	DESCRIPTION
	50490674	PCB Assy
	50484110	PCB
TRANSISTORS		
Q401, Q402	50424750	2SC1384 (Q-S)
	50333040	Heat Sink
DIODE		
D18	50422560	S1B01-02
RELAY		
K401	50611380	4PDT DC24V

REF. NO.	PARTS NO.	DESCRIPTION
RESISTORS		
R401	50526390	Wire Wound 56 ohm 1W
R402	50574900	Carbon 2.2 k ohm 1/2W
R403	50570720	Carbon 390 ohm 1/2W
R404, R405	50574980	Carbon 4.7 k ohm 1/2W
R406, R407	50574460	Carbon 33 ohm 1/2W
R408	50574500	Carbon 47 ohm 1/2W
CAPACITORS		
C401	50554380	Elec. 220 mfd 35V
C402, C403	50548910	Mylar 0.0047 mfd 50V 5%
C404	50548870	Mylar 0.015 mfd 50V 5%
C405	50544040	Mica 4200 pfd 300V
C406	50549920	Metalized Mylar 0.1 mfd 400V
C407	50556820	Elec. 3.3 mfd 50V
C408	51700160	Mylar 0.033 mfd 150V

TRIMMER CAPACITORS

VC401, VC402	50547070	MAX. 80 pfd
VC403, VC404	50547070	MAX. 80 pfd

COIL/OSCILLATOR

L401	50566581	Coil, Dummy 3mH
T401	50563550	Oscillator

2-5. CONTROL PC BOARD(A-3300SX)

REF. NO.	PARTS NO.	DESCRIPTION
	50490696	PCB Assy
	50484131	PCB
TRANSISTOR		
Q1	50424620	2SD235 (Y)
DIODES		
D9~D15	50422560	S1B01-02
RELAYS		
K1	50611380	4PDT, DC24V
K2	50611120	3PDT, DC24V
K3	50611160	DPDT, DC24V
K4	50611400	SPDT, DC24V
K5	50611410	SPDT, DC24V

2-7. SWITCH MOUNTING PC BOARD

REF. NO.	PARTS NO.	DESCRIPTION
RESISTORS		
R9	50574740	Carbon, 470 ohm 1/2W
R10	50571100	Carbon, 15 k ohm 1/2W
R13	50525720	Wire Wound, 10 ohm 1/2W
R20	50571160	Carbon, 27 k ohm 1/2W
CAPACITORS		
C7	51703050	Elect. 100 mfd 35V 10%
C9	50554620	Elec. 470 mfd 35V
C10, C12	50554980	Elec. 2.2 mfd 50V
C20	50554720	Elec. 22 mfd 10V
C101~C113	50549920	Meta. Mylar 0.1 mfd 400V AC
CR102~CR108	50529050	Spark Killer 0.1 mfd + 120 ohm 400V

2-6. CONTROL PC BOARD (A-2300SX)

REF. NO.	PARTS NO.	DESCRIPTION
	51680855	PCB Assy
	51670623	PCB
TRANSISTOR		
Q1	50424620	2SD235 (Y)
DIODES		
D9, D10	50422560	1S1801-02
D12~D15	50422560	1S1801-02
D18	50422560	1S1801-02
RELAYS		
K1	50611380	4PDT, DC24V
K2	50611120	3PDT, DC24V
K3	50611160	DPDT, DC24V
K4	50611400	SPDT, DC24V
K5	50611410	SPDT, DC24V
RESISTORS		
R9	50574740	Carbon, 470 ohm 1/2W
R10	50575060	Carbon, 10 k ohm 1/2W
CAPACITORS		
C7	50554630	Elec. 10 mfd 35V
C10	50554980	Elec. 2.2 mfd 50V
C12	50554080	Elec. 4.7 mfd 50V
C101~C109	50549920	Meta. Mylar 0.1 mfd 400V AC
C111	50549920	Meta. Mylar 0.1 mfd 400V AC
C114, C115	50549920	Meta. Mylar 0.1 mfd 400V AC
CR102, C103	50529050	Spark Killer 0.1 mfd + 120 ohm 400V
CR105, C108	50529050	Spark Killer 0.1 mfd + 120 ohm 400V
CR107~CR110	50529050	Spark Killer 0.1 mfd + 120 ohm 400V

REF. NO.	PARTS NO.	DESCRIPTION
	51683310	PCB Assy
	51673310	PCB
D701, D703	50422130	Diode, 1N60
D702, D704	50422130	Diode, 1N60
R701, R702	51812840	Resistor, Carbon 1.2 k ohm 1/2W
C701, C702	50554880	Capacitor, Elec. 22 mfd 16V

2-8. RECTIFIER PC BOARD

REF. NO.	PARTS NO.	DESCRIPTION
	51685521	PCB Assy (A-3300SX)
	51685511	PCB Assy (A-2300SX)
	50484171	PCB
D3~D6	50422560	Diode, 1S1801-02
D7, D8	50422570	Diode, 1S1801-08
K6	50611160	Relay, MY2-0 DC24V (A-3300SX)
K7	50611160	Relay, MY2-0 DC24V (A-3300SX)
K8	50611120	Relay, MY3-0 DC24V (A-3300SX)
R5	50520340	Resistor, Cement 1.5 ohm 3W
R6	50525440	Resistor, Wire Wound 3.3 ohm 1W
R8	50526150	Resistor, Wire Wound 0.5 ohm 2W
C2	50555700	Capacitor, Elec. 1000 mfd 50V
C3	50555110	Capacitor, Elec. 1000 mfd 35V
C4	50555660	Capacitor, Elec. 2200 mfd 16V
C16	50555110	Capacitor, Elec. 1000 mfd 35V
C301~C309	50548390	Capacitor, Metallized Mylar 0.1 mfd 400V AC (A-3300SX)
CR301~CR303	50529050	Spark Killer 0.1 mfd + 120 ohm 400V (A-3300SX)
	51812080	Jumper, JPW2

2-9. CONTROL RELAY PC BOARD

REF. NO.	PARTS NO.	DESCRIPTION
	50491593	PCB Assy (A-3300SX CANADA)
	50491601	PCB Assy (A-3300SX EUROPE, U.K.)
	50491583	PCB Assy (A-2300SX CANADA)
	50491691	PCB Assy (A-2300SX EUROPE, U.K.)
	50484071	PCB

A-3300SX / A-2300SX Stereo Tape Deck

ASSEMBLING HARDWARE CODING LIST

All screws conform to ISO standards, and have crossrecessed heads, unless otherwise noted. ISO screws have the head inscribed with a point as in the figure to the right.



FOR EXAMPLE:

B M3 x 6
 ----- Length in mm (L)
 ----- Diameter in mm (D)
 ----- Metric System
 ----- Nomenclature

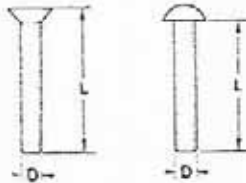

* Inner dia. for washers and nuts

	Code	Name	Type		Code	Name	Type
MACHINE SCREW	R	Round Head Screw		TAPPING SCREW	BTA	Binding Head Tapping Screw (A Type)	
	P	Pan Head Screw			BTB	Binding Head Tapping Screw (B Type)	
	T	Stove Head Screw (Truss)			RTA	Round Head Tapping Screw (A Type)	
	B	Binding Head Screw			RTB	Round Head Tapping Screw (B Type)	
	F	Flat Countersunk Head Screw		SETSCREW	SF	Hex Socket Setscrew (Flat Point)	
	O	Oval Countersunk Head Screw			SC	Hex Socket Setscrew (Cup Point)	
WOOD SCREW	RW	Round Head Wood Screw		WASHER	SS	Slotted Socket Setscrew (Flat Point)	
	FW	Flat Countersunk Wood Screw			E	E-Ring (Retaining Washer)	
	OW	Oval Countersunk Wood Screw			W	Flat Washer (Plain)	
SEMS SCREW	BSA	Binding Head SEMS Screw (A Type)			SW	Lock Washer (Spring)	
	BSB	Binding Head SEMS Screw (B Type)			LWI	Lock Washer (Internal Teeth)	
	BSF	Binding Head SEMS Screw (F Type)		LWE	Lock Washer (External Teeth)		
	PSA	Pan Head SEMS Screw (A Type)		TW	Tom Washer (Countersunk)		
	PSB	Pan Head SEMS Screw (B Type)		NUT	N	Hex Nut	

TEAC CORPORATION

3-7-3 NAKA-CHO MUSASHINO TOKYO PHONE (0422) 53-1111

TEAC CORPORATION OF AMERICA

7733 TELEGRAPH ROAD MONTEBELLO CALIFORNIA 90640 PHONE (213) 726-0303

TEAC AUSTRALIA PTY., LTD.

165-167 GLADSTONE STREET SOUTH MELBOURNE VICTORIA 3205 PHONE 699-6000

PRINTED IN JAPAN 117V K05 030 0-2584

