

TEAC

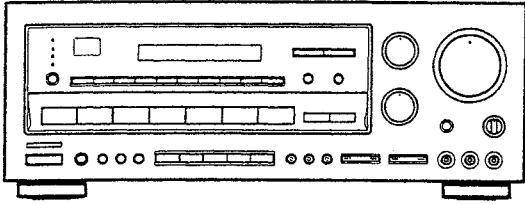

SERVICE MANUAL

AG-V8500/AG-V8060

Audio/Video Surround Receiver

NOTES

- PC boards shown are viewed from parts side.
- The parts with no reference number or no parts number in the exploded views are not supplied.
- As regards the resistors and capacitors, refer to the circuit diagrams contained in this manual.
- Δ Parts marked with this sign are safety critical components. They must be replaced with identical components - refer to the appropriate parts list and ensure exact replacement.
- Parts of [] mark can be used only with the version designated.
[US]: U. S. A. [C]: CANADA [SA]: SOUTH AMERICA [E]: EUROPE [UK]: U. K.
AG-V8500: US/C/E/UK AG-V8060: US/C/SA

1 SPECIFICATIONS

Amplifier Section

Output Power (Front):

F.T.C. Rating:

130 watts RMS per channel minimum, both channels driven into 8 ohms from 20 Hz to 20 kHz with no more than 0.09% total harmonic distortion (U.S.A./Canada)

RMS Power (40 Hz – 20 kHz):

130 watts/8 ohms, 0.09% (Europe/General Export)

Surround Output Power (0.5% THD, 1 kHz, 8 ohms):

100 + 100 watts (Front)

100 watts (Center)

100 watts (Rear)

Total Harmonic Distortion (Front):

0.02% (at 120 watts, 1 kHz)

Delay Time:

DOLBY PRO LOGIC: 15 – 30 ms

HALL, THEATER: 15 – 50 ms

Input Sensitivity/Impedance:

PHONO: 2.5 mV/47 k ohms

LINE*: 220 mV/47 k ohms

Frequency Response:

PHONO: 20 Hz – 20 kHz, ± 1 dB

LINE*: 10 Hz – 60 kHz, +1/– 3 dB

Signal-to-Noise Ratio:

PHONO: 70 dB (IHF-A)

LINE*: 90 dB (IHF-A)

Tone Control:

BASS: ± 10 dB at 100 Hz

TREBLE: ± 10 dB at 10 kHz

FM Tuner Section

(without notes 100.1 MHz, 65 dBf)

Tuning Range:

87.5 MHz – 108.0 MHz (100 kHz steps)

(U.S.A./Canada/General Export)

87.50 MHz – 108.00 MHz (50 kHz steps)

(Europe)

Usable Sensitivity (IHF):

Mono: 15 dBf

50 dB Quieting Sensitivity:

Mono: 23 dBf

Stereo: 40 dBf

Capture Ratio: 2.0 dB

Image Rejection Ratio: 40 dB

AM Suppression Ratio: 40 dB

Total Harmonic Distortion (1 kHz):

Mono: 0.4%

Stereo: 0.5%

Frequency Response:

30 Hz – 15 kHz, +1/– 1.5 dB

Stereo Separation (1 kHz): 40 dB

Signal-to-Noise Ratio:

Mono: 65 dB

Stereo: 60 dB

AM Tuner Section

Tuning Range:

530 kHz – 1,720 kHz (10 kHz steps)

(U.S.A./Canada/General Export)

522 kHz – 1,620 kHz (9 kHz steps)

(Europe)

Usable Sensitivity: 55 dB/m

Total Harmonic Distortion:

0.8% at 85 dB/m

Signal-to-Noise Ratio:

45 dB at 85 dB/m

Video Section

Input Sensitivity/Impedance:

1.0 V_{p-p}/75 ohms

Output Level/Impedance:

1.0 V_{p-p}/75 ohms

General

Power Requirements:

120 V AC, 60 Hz (U.S.A./Canada)

230 V AC, 50 Hz (Europe)

120/230 V AC, 50-60 Hz (General Export)

Power Consumption:

3.0 A (U.S.A./Canada)

320 W (Europe/General Export)

AC Outlets:

Switched $\times 2$, 100 W max. (1 A max.)

(U.S.A./Canada)

Switched $\times 2$, 100 W max.

(Europe/General Export)

Dimensions (WxHxD):

435 \times 165 \times 345 mm

Weight (net):

9.0 kg (U.S.A./Canada/General Export)

10.0 kg (Europe)

Standard Accessories:

AM Loop Antenna $\times 1$

FM "T" Type Antenna $\times 1$ (U.S.A./Canada/

General Export)

FM Lead-type Antenna $\times 1$ (Europe)

Remote Control Unit (UR-410) $\times 1$

* LINE means CD, VIDEO 1, VIDEO 2, DVD/VIDEO 3 and TAPE.

● Improvements may result in specifications and features changing without notice.

● Illustrations may differ slightly from production models.

2 ADJUSTMENT AND CHECKS

Setting

AM signal generator

Modulation: 30%

Modulation frequency: 400 Hz

FM signal generator

Modulation: 100% (75 kHz)

Modulation frequency: 400 Hz

Keep the signal input as low as possible to adjust accurately.

Adjustment locations

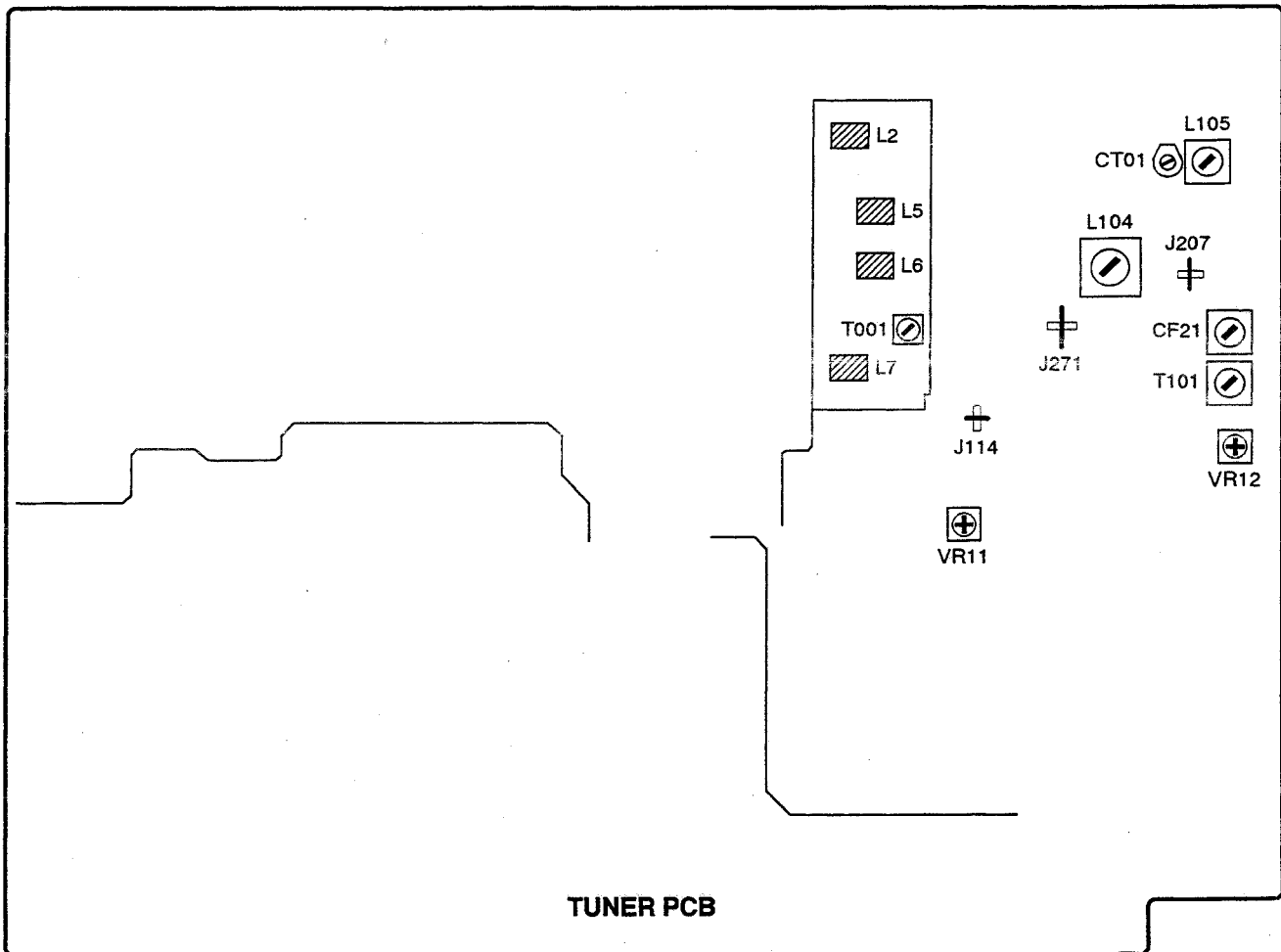

1. TUNING FREQUENCY RANGE ADJUSTMENTS

Step	Band	Frequency	Adjust for	Adjustment
1	FM	87.50MHz	J114: DC1.5V	L7
2	AM	522kHz* / 530kHz**	J114: DC1.0V	L105

* Europe, General Export model ** USA, Canada model

2. AM TRACKING ADJUSTMENT

Step	Frequency	Adjust for	Adjustment
1	612kHz* / 610kHz**	Maximum sensitivity	L104
2	1503kHz* / 1500kHz**	Maximum sensitivity	CT01
3	Repeat step 1 and 2 several times		

* Europe, General Export model ** USA, Canada model

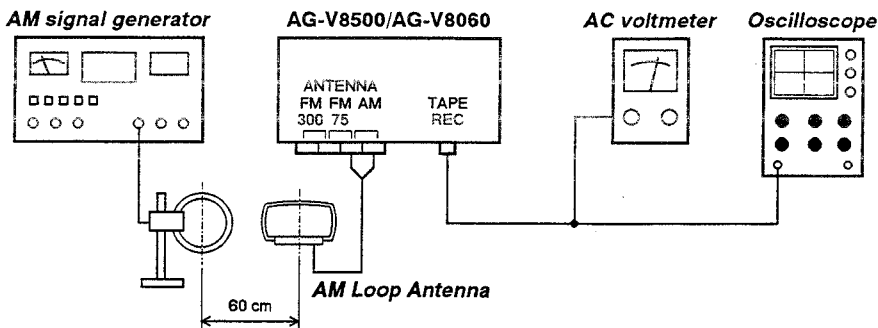

3. FM-RF ADJUSTMENT

Step	Frequency	Adjust for	Adjustment
1	87.50MHz	Maximum sensitivity	L2, L5, L6
2	Repeat step 1 several times		

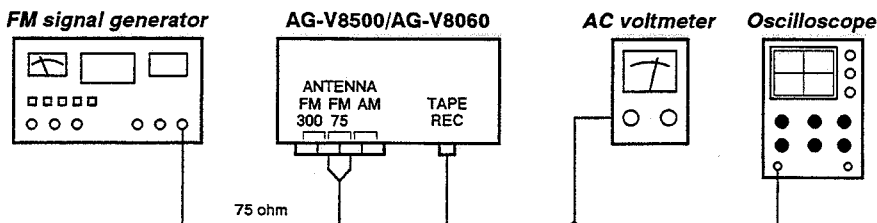

4. FM MONO DISTORTION ADJUSTMENT

Step	Frequency	Adjust for	Adjustment
1	100.10MHz	J271 - J207: DC 0V	T101
2	Repeat step 1 several times		

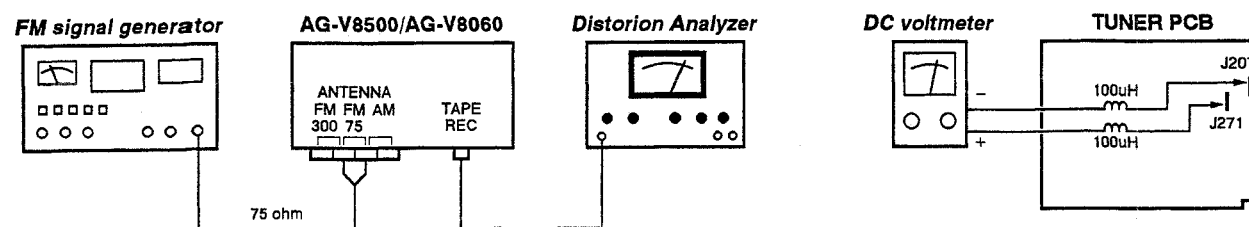

5. FM STEREO SEPARATION

Pilot Signal	Adjust for	Adjustment
ON	Different of R or L must be maximum	T001

Note: In case of adjusting the stereo separation of input is L (or R) channel, R (or L) channel must be maximum.

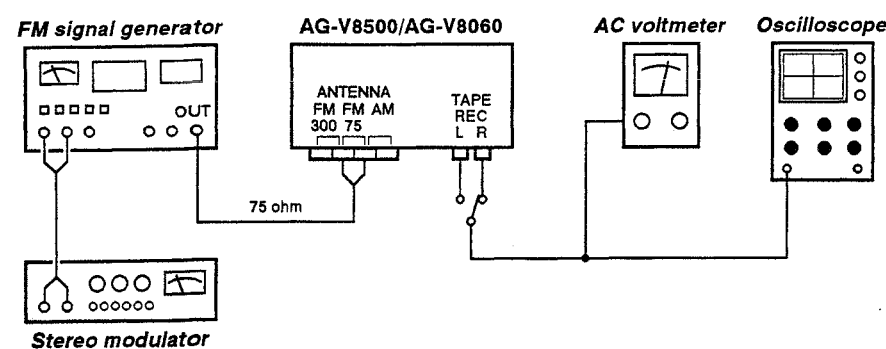

6. FM/AM AUTO STOP LEVEL ADJUSTMENT

Band	Step	Frequency	SG Output Level	Adjust for	Adjustment
AM	1	999kHz* / 990kHz**	80dB/m	TUNED Display OFF	VR12
	2	999kHz* / 990kHz**	80dB/m	TUNED Display ON	VR12
FM	1	100.1MHz	35dB	TUNED Display OFF	VR11
	2	100.1MHz	35dB	TUNED Display ON	VR11

* Europe, General Export model ** USA, Canada model

Note: You must adjust AM auto stop level at first. Because AM auto stop level adjustment can be changed FM auto stop level.

3 EXPLODED VIEWS AND PARTS LIST

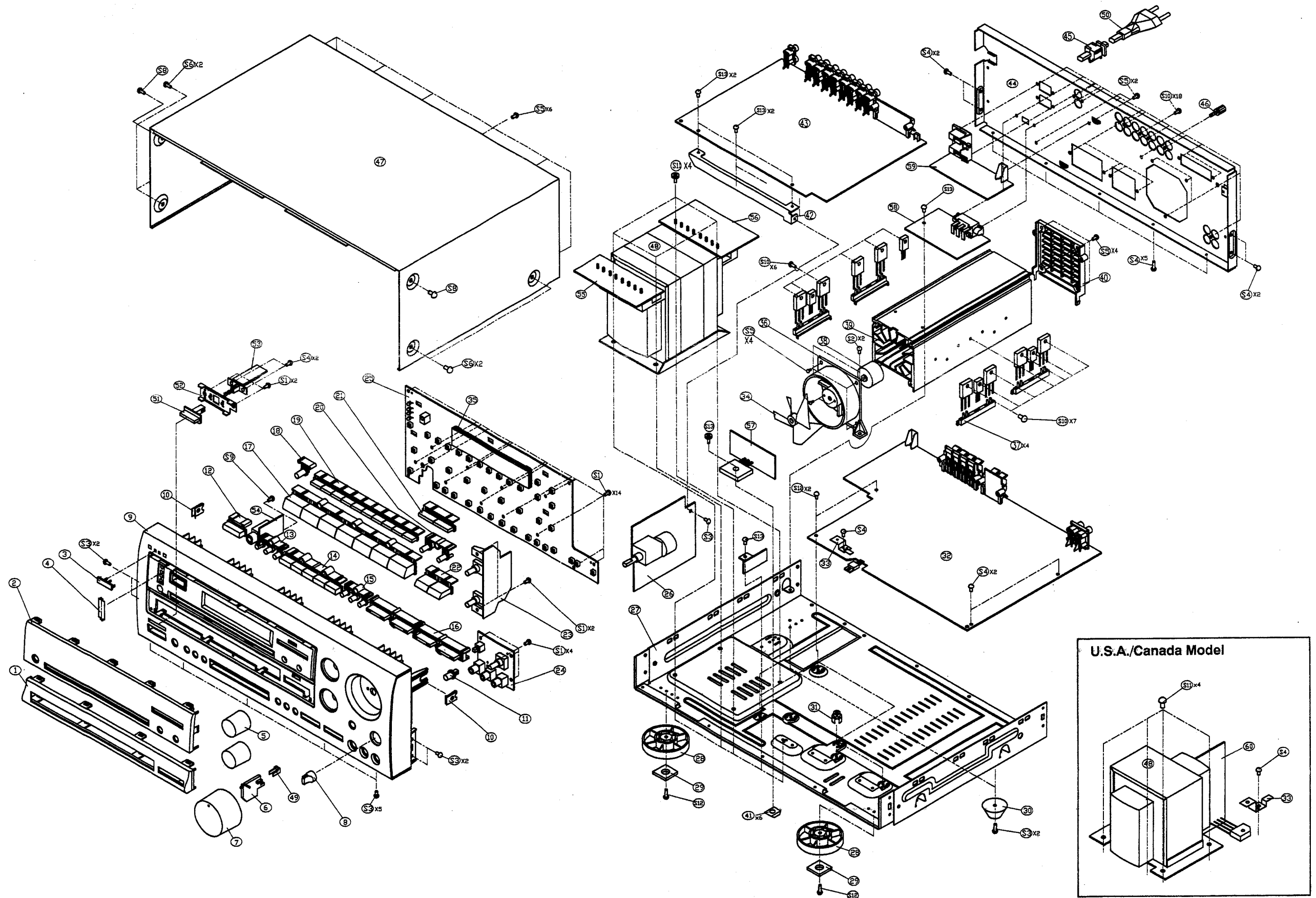

EXPLODED VIEW

REF. NO.	PARTS NO.	DESCRIPTION	REMARKS
1- 1	9A06777600	ORNAMENT, KNOB	AG-V8500
	9A06754200	ORNAMENT, KNOB	AG-V8060
1- 2	9A06777700	WINDOW, FIP	AG-V8500
	9A06754300	WINDOW, FIP	AG-V8060
1- 3	9A05898400	BADGE, TEAC (GOLD)	
1- 4	9A06754500	SHEET, LED	
1- 5	9A06752700	KNOB, ROTARY	
1- 6	9A06754100	INDICATOR, VOL	
1- 7	9A06752900	KNOB, VOLUME	
1- 8	9A06752800	KNOB, BALANCE	
1- 9	9A06777800	PANEL, FRONT [US, C]	AG-V8500
	9A06787300	PANEL, FRONT [E, UK]	AG-V8500
	9A06754400	PANEL, FRONT	AG-V8060
1-10	9A03741300	U-NUT	
1-11	9A06752600	KNOB, LOUDNESS	
1-12	9A06777500	KNOB, POWER	AG-V8500
	9A06754000	KNOB, POWER	AG-V8060
1-13	9A06776700	KNOB, SPEAKER	AG-V8500
	9A06753200	KNOB, SPEAKER	AG-V8060
1-14	9A06777200	KNOB, SURROUND	AG-V8500
	9A06753700	KNOB, SURROUND	AG-V8060
1-15	9A06777100	KNOB, TONE	AG-V8500
	9A06753600	KNOB, TONE	AG-V8060
1-16	9A06776500	KNOB, LEVEL	AG-V8500
	9A06753000	KNOB, LEVEL	AG-V8060
1-17	9A06777400	KNOB, FUNCTION	AG-V8500
	9A06753900	KNOB, FUNCTION	AG-V8060
1-18	9A06776800	KNOB, DIRECT	AG-V8500
	9A06753300	KNOB, DIRECT	AG-V8060
1-19	9A06777300	KNOB, PRESET	AG-V8500
	9A06753800	KNOB, PRESET	AG-V8060
1-20	9A06776900	KNOB, MODE	AG-V8500
	9A06753400	KNOB, MODE	AG-V8060
1-21	9A06777000	KNOB, TUNING	AG-V8500
	9A06753500	KNOB, TUNING	AG-V8060
1-22	9A06776600	KNOB, BAND	AG-V8500
	9A06753100	KNOB, BAND	AG-V8060
1-23	-----	TONE PCB ASSY	FRONT PCB ASSY (3/8)
1-24	-----	LOUD PCB ASSY	FRONT PCB ASSY (4/8)
1-25	-----	MICOM PCB ASSY	FRONT PCB ASSY (1/8)
1-26	-----	VOL PCB ASSY	FRONT PCB ASSY (2/8)
1-27	9A06755900	CHASSIS, BOTTOM	
1-28	9A05891400	FOOT, FRONT	
1-29	9A06754800	RUBBER, CUSHION	
1-30	9A06755300	FOOT, RUBBER (BLACK)	
1-31	9A01375500	PCB HOLDER	
1-32	-----	MAIN PCB-1 ASSY	MAIN PCB ASSY (1/2)
1-33	9A06755600	BRACKET, TR	
1-34	9A06678800	FAN	
1-35	9A05961600	BRACKET, FLT	
1-36	9A06678900	FRAME FAN	
1-37	9A06679200	TR SUPPORT	
1-38	9A06679000	MOTOR	

EXPLODED VIEW

REF. NO.	PARTS NO.	DESCRIPTION	REMARKS
1-39	9A06768600	HEAT SINK	
1-40	9A06679300	H/S COVER	
1-41	9A05921700	RUBBER	
1-42	9A06755500	BRACKET, PCB	
1-43	9A06761200	TUNER PCB ASSY [US, C, SA]	
	9A06761230	TUNER PCB ASSY [E, UK]	
1-44	9A06777900	PANEL, REAR [US, C]	AG-V8500
	9A06784000	PANEL, REAR [E]	AG-V8500
	9A06786900	PANEL, REAR [UK]	AG-V8500
	9A06755200	PANEL, REAR [US, C]	AG-V8060
	9A06769300	PANEL, REAR [SA]	AG-V8060
1-45	△ 9A06754900	BUSHING, AC CORD [US, C, SA, UK]	
	△ 9A06783800	BUSHING, AC POWER CORD [E]	
1-46	9A05917200	GROUND TERMINAL	
1-47	9A06755100	CABINET, TOP	
1-48	△ 9A06755400	TRANS, POWER [US, C]	
	△ 9A06755410	TRANS, POWER [SA]	
	△ 9A06784100	TRANS, POWER [E, UK]	
1-49	9A06754600	FIXER, VOL	
1-50	△ 9A06755000	CORD, POWER [US, C]	
	△ 9A06755010	CORD, POWER [SA]	
	△ 9A06784800	CORD, AC [E]	
	△ 9A06730800	CORD, POWER [UK]	
1-51	9A06783600	KNOB, POWER (PUSH) [E, UK]	AG-V8500
1-52	9A06783700	BRACKET, POWER [E, UK]	AG-V8500
1-53	-----	PWR SW PCB ASSY [E, UK]	FRONT PCB ASSY (8/8)
1-54	-----	PHONES PCB ASSY	FRONT PCB ASSY (5/8)
1-55	-----	POWER PCB-2 ASSY [SA, E, UK]	POWER PCB ASSY (2/3)
1-56	-----	POWER PCB-1 ASSY [SA, E, UK]	POWER PCB ASSY (1/3)
1-57	-----	POWER PCB-3 ASSY [SA, E, UK]	POWER PCB ASSY (3/3)
1-58	-----	VOLT SEL PCB ASSY [SA]	FRONT PCB ASSY (7/8)
1-59	-----	OUTLET PCB ASSY [US, C, SA, E]	FRONT PCB ASSY (6/8)
1-60	-----	MAIN PCB-2 ASSY [US, C]	MAIN PCB ASSY (2/2)
1-S1	9A01377400	SCREW, KTB3+10G	
1-S2	9A06679700	SCREW, KTB3+14J	
1-S3	9A05338600	SCREW, KTB3+6JFZ	
1-S4	9A01532600	SCREW, KTB3+6J	
1-S5	9A05338600	SCREW, KTB3+6JFZ	
1-S6	9A06053100	SCREW, KTB4+8FFZ	
1-S8	9A05338700	SCREW, KTB4+10JFZ	
1-S9	9A01377600	SCREW, KTWS3+10G	
1-S10	9A01377300	SCREW, KTB3+10GFZ	
1-S11	9A01477800	SCREW, KTB4+8F	
1-S12	9A05339100	SCREW, KTW3+12J	
1-S13	9A05339200	SCREW, KTW3+8J	

4 WIRING DIAGRAM

U.S.A./Canada Model

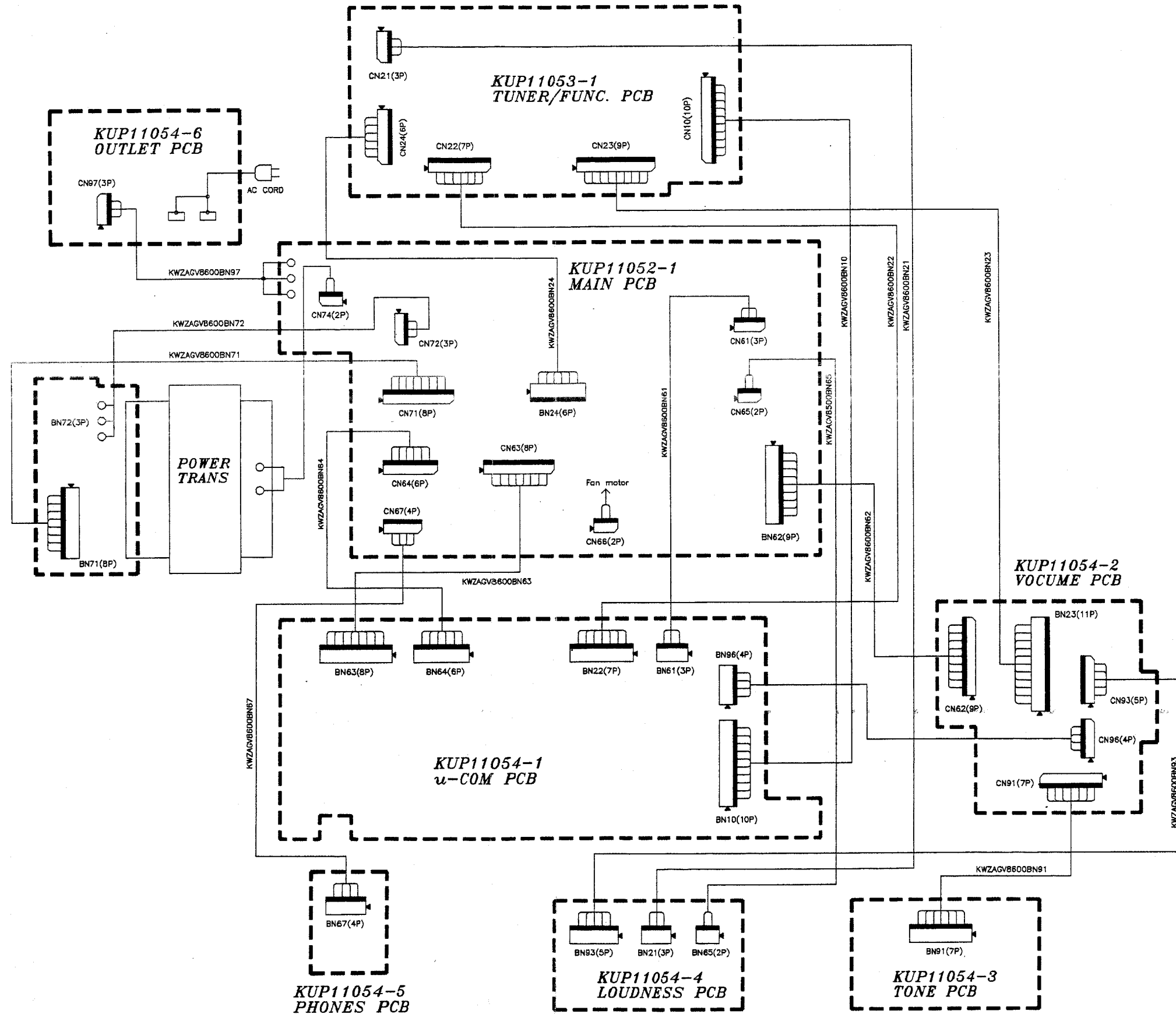

FRONT PCB-1 (MICOM PCB)

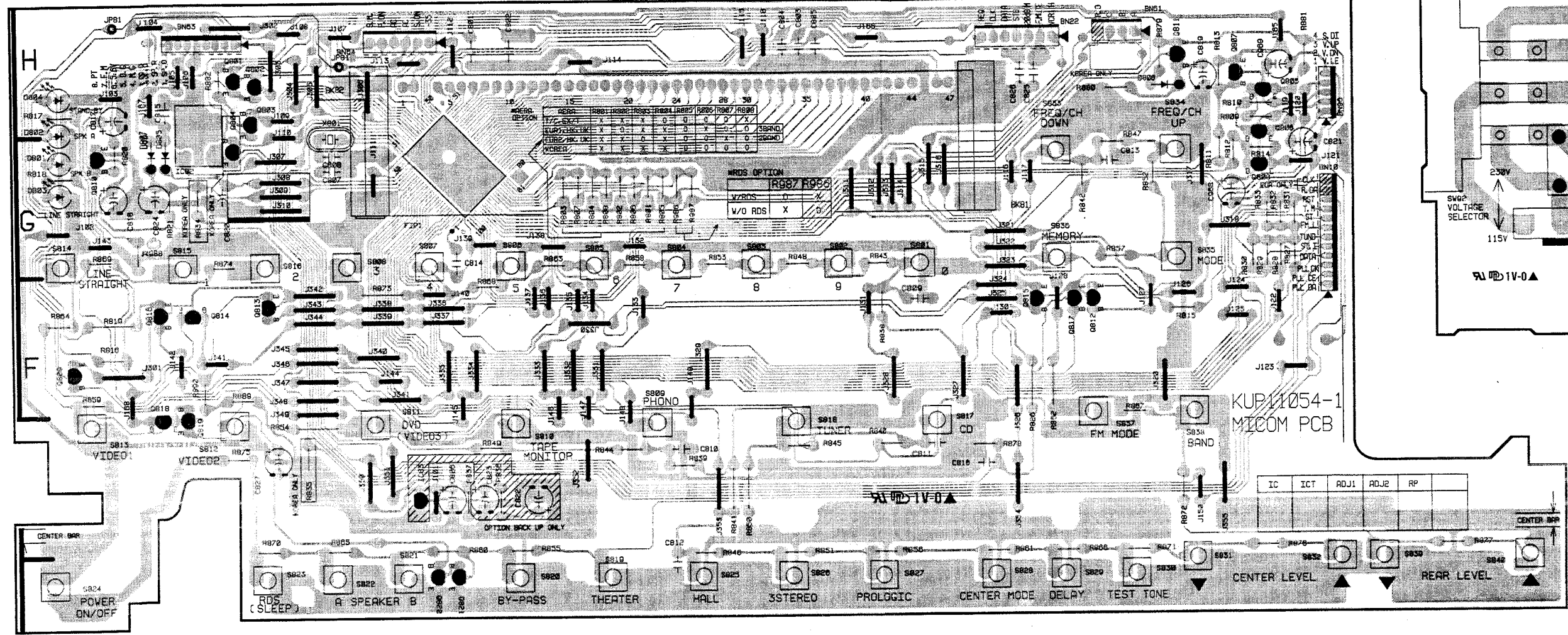

FRONT PCB-7 (VOLT SEL PCB)

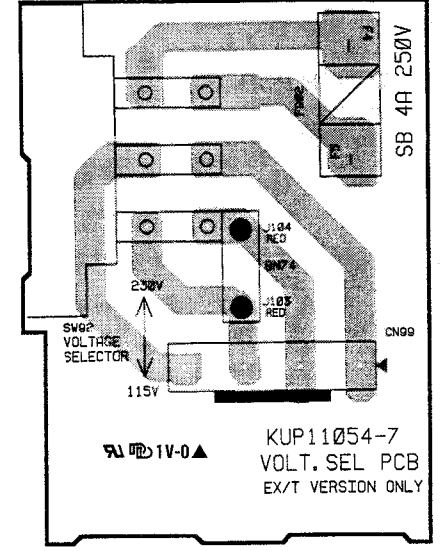

FRONT PCB-3 (TONE PCB)

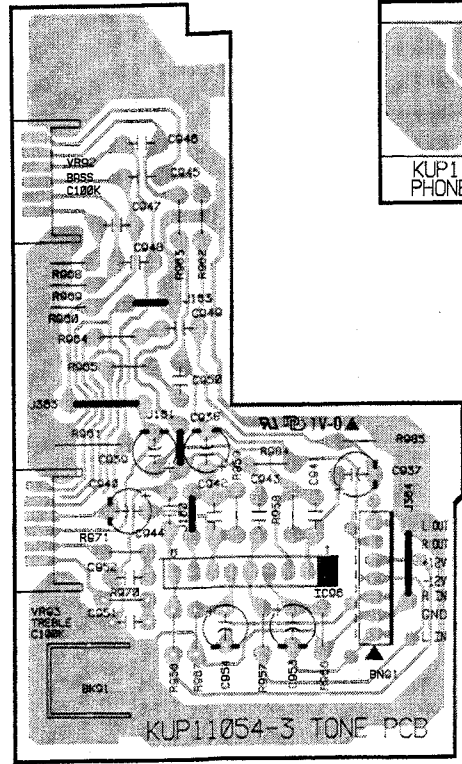

FRONT PCB-5 (PHONES PCB)

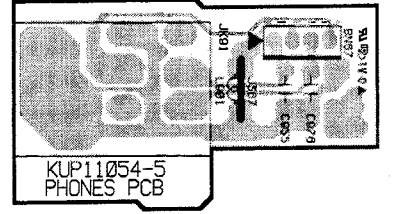

FRONT PCB-8 (PWR SW PCB)

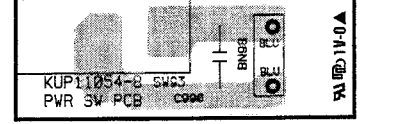

FRONT PCB-4 (LOUD PCB)

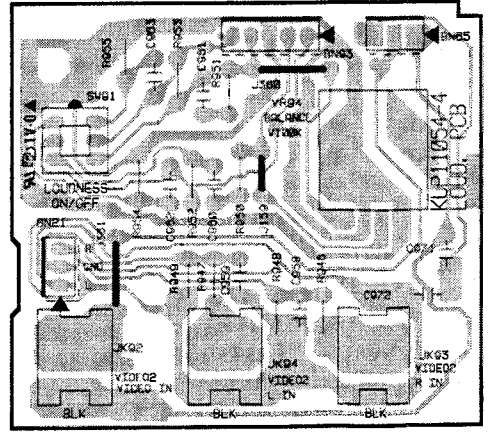

FRONT PCB-2 (VOL PCB)

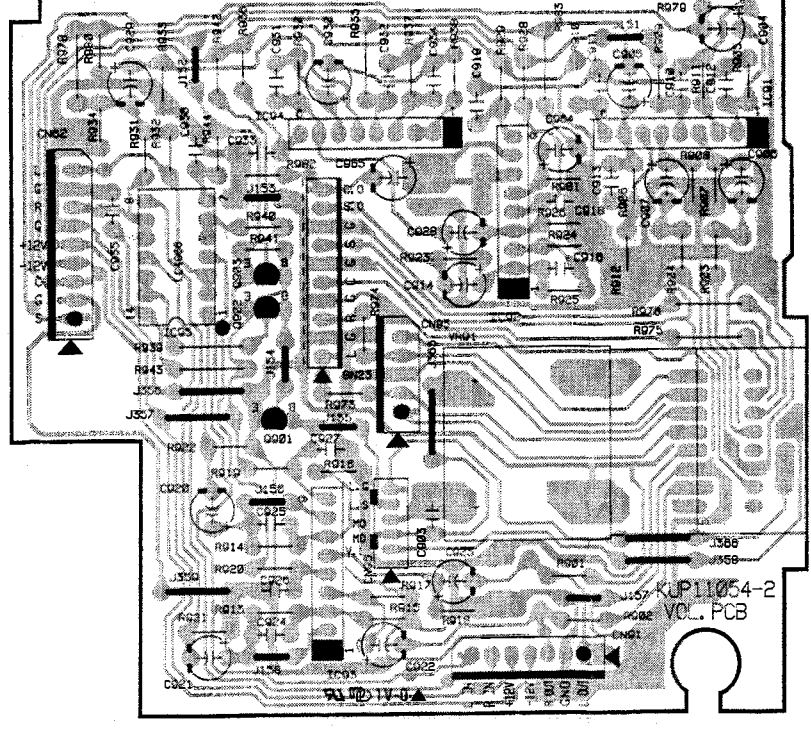

FRONT PCB-6 (OUTLET PCB)

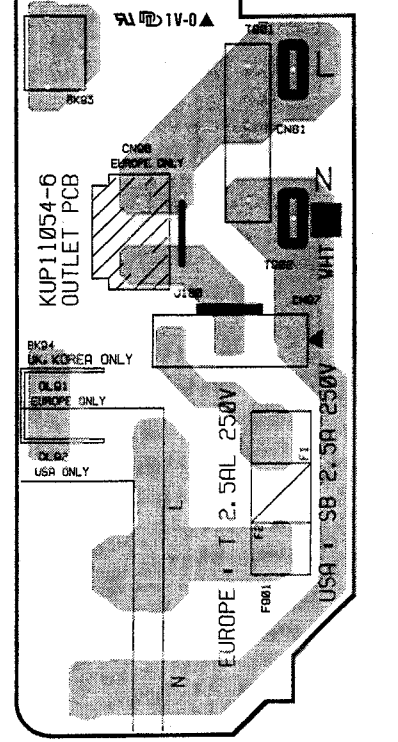

TUNER PCB

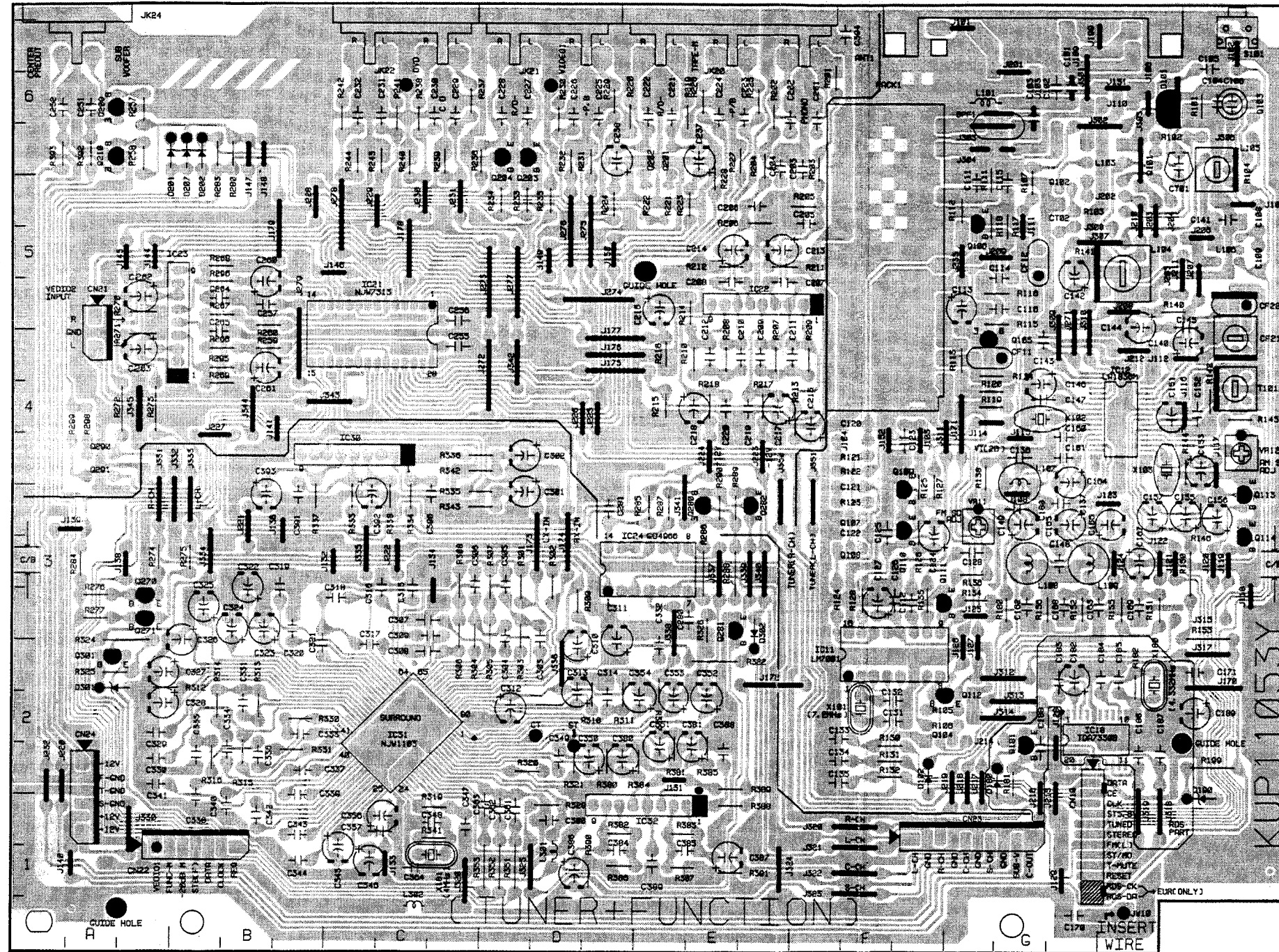

POWER PCB-2

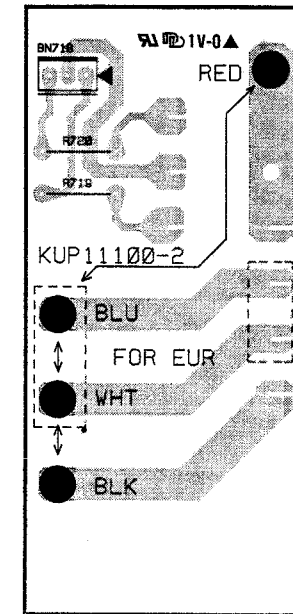

POWER PCB-3

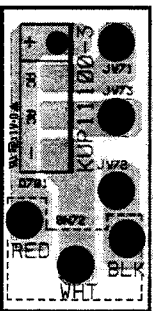

POWER PCB-1

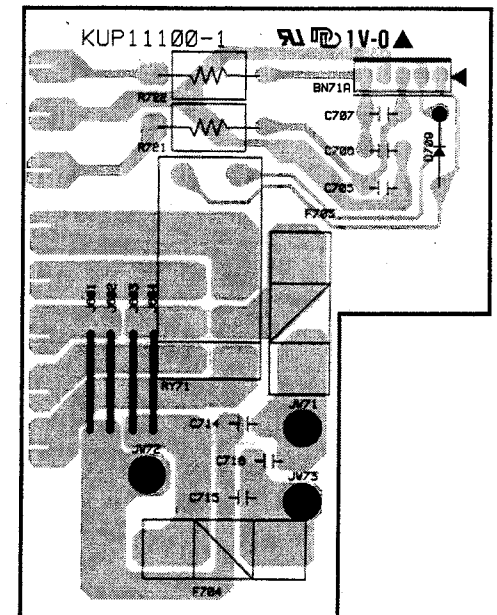

TEAC SCHEMATIC DIAGRAM AG-V8500/AG-V8060 FRONT PCB

1 2 3 4 5 6

A
B
C
D
E
F
G
H

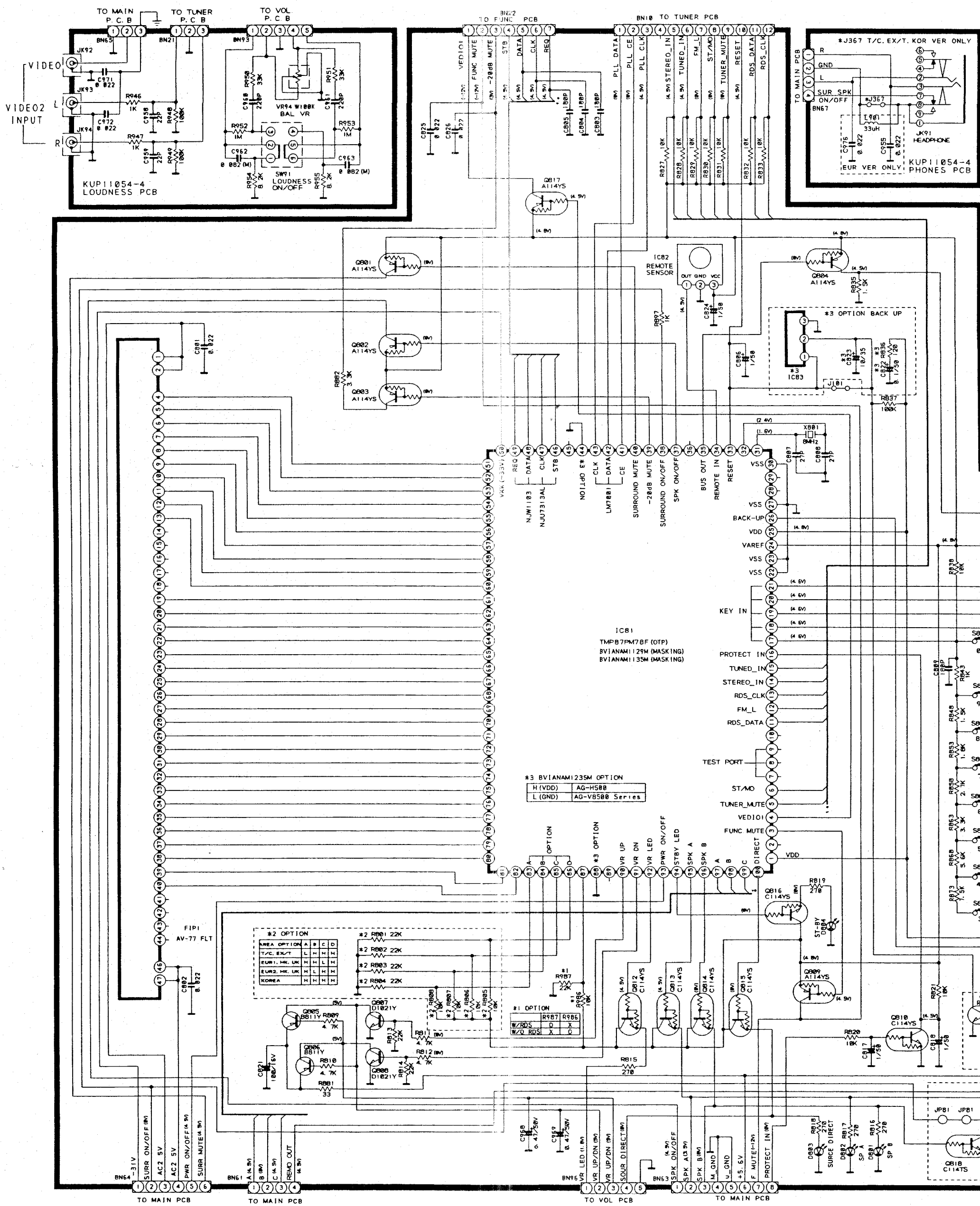

INSTRUCTIONS FOR SERVICE PERSONNEL
 BEFORE RETURNING APPLIANCE TO THE CUSTOMER, MAKE LEAKAGE-CURRENT OR RESISTANCE MEASUREMENTS TO DETERMINE THAT EXPOSED PARTS ARE ACCEPTABLY INSULATED FROM THE SUPPLY CIRCUIT.

NOTES:
 1. Resistor values are in ohms (k=kilo-ohms, M=megohms).
 2. Capacitor values are in microfarads (p=picofarads).
 3. Δ Parts marked with this sign are safety critical components. They must always be replaced with identical components-refer to the appropriate parts list and ensure exact replacement.

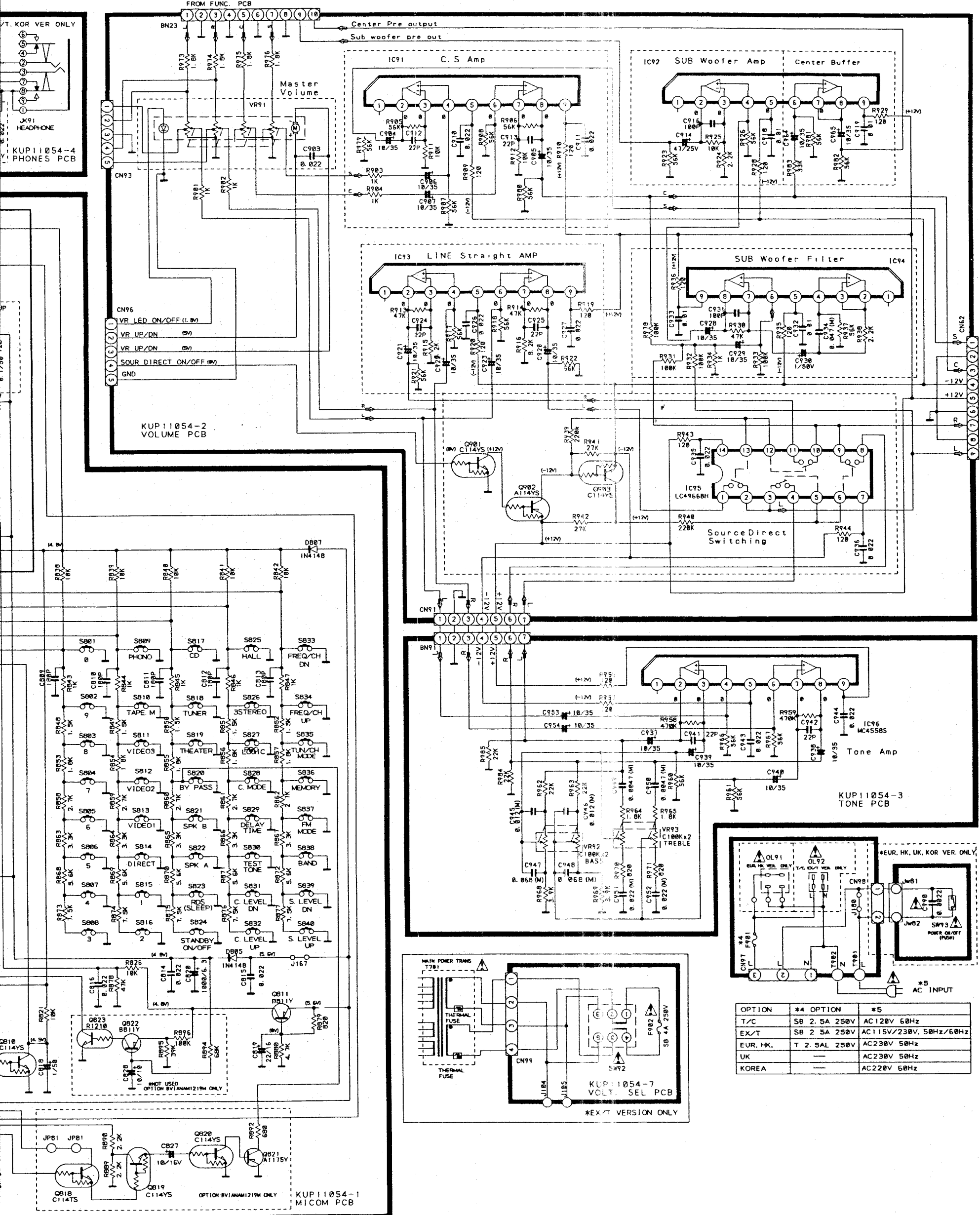

OPTION	*4 OPTION	*5
T/C	SB 2.5A 250V	AC120V 60Hz
EX/T	SB 2.5A 250V	AC115V/230V, 50Hz/60Hz
EUR. HK.	T 2.5AL 250V	AC230V 50Hz
UK	—	AC230V 50Hz
KOREA	—	AC220V 60Hz

AG-V8500/AG-V8060

Audio/Video Surround Receiver

A

B

C

D

E

F

G

H

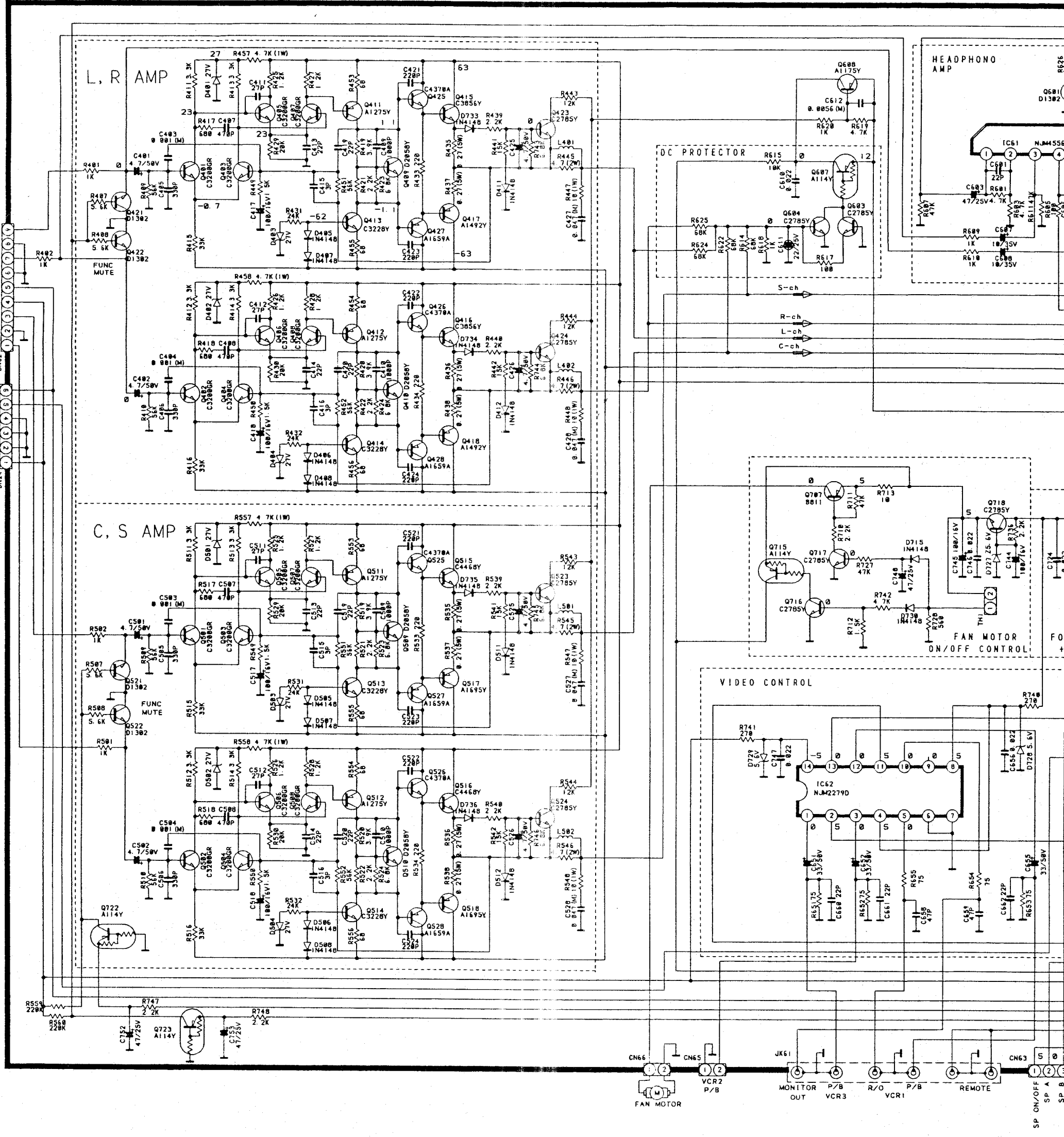

INSTRUCTIONS FOR SERVICE PERSONNEL
 BEFORE RETURNING APPLIANCE TO THE CUSTOMER, MAKE LEAKAGE-CURRENT OR RESISTANCE MEASUREMENTS TO DETERMINE THAT EXPOSED PARTS ARE ACCEPTABLY INSULATED FROM THE SUPPLY CIRCUIT.

NOTES:
 1. Resistor values are in ohms (k=kilohms, M=megohms).
 2. Capacitor values are in microfarads (p=picofarads).
 3. Δ Parts marked with this sign are safety critical components. They must always be replaced with identical components-refer to the appropriate parts list and ensure exact replacement.

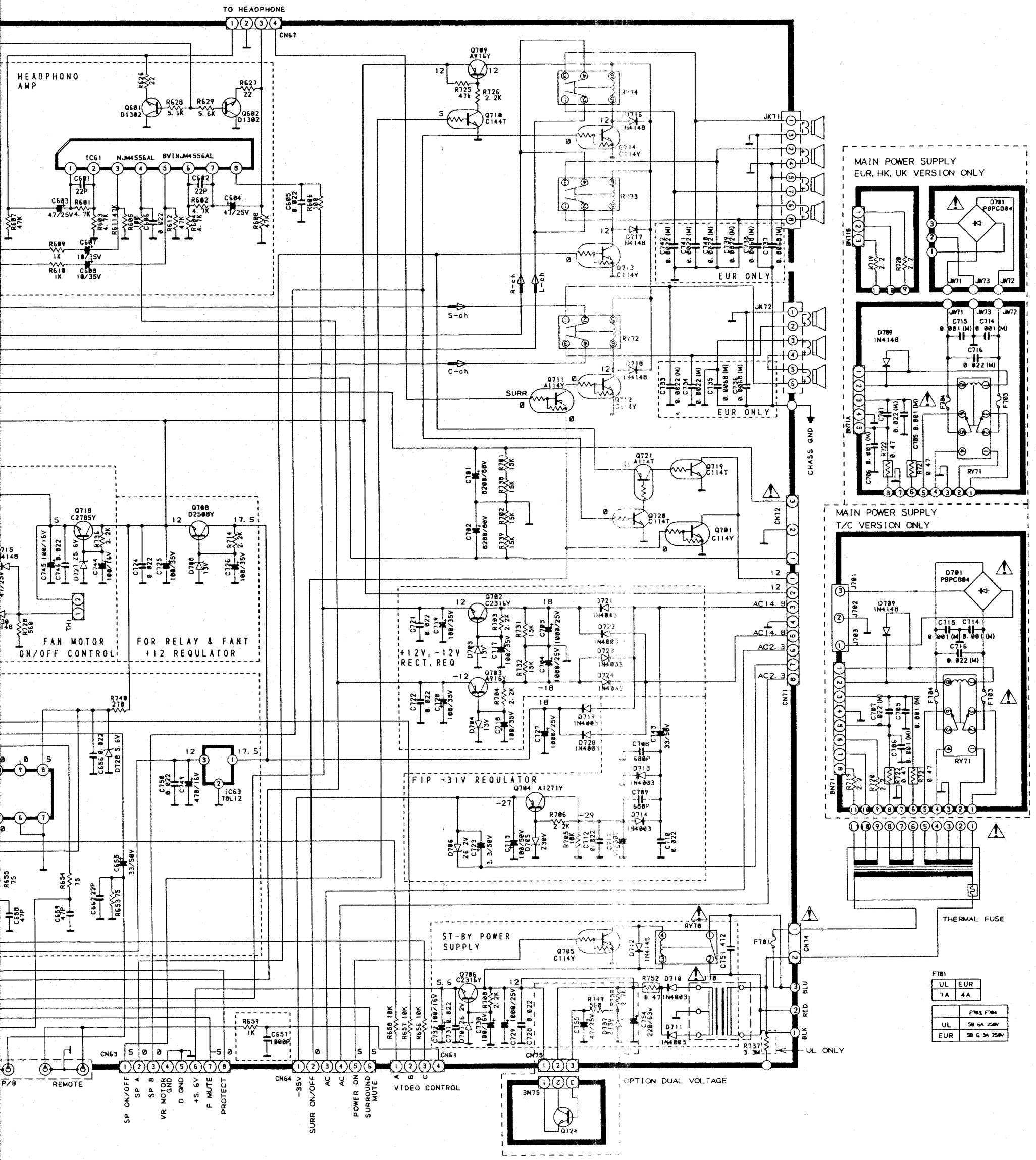

MAIN POWER SUPPLY
EUR, HK, UK VERSION ONLY

MAIN POWER SUPPLY
T/C VERSION ONLY

THERMAL FUSE

F781	UL	EUR
	7A	4A
	UL	5B GA 250V
	EUR	5B GA 250V

AG-V8500/AG-V8060

Audio/Video Surround Receiver

ONLY 2BAND
J1, J2, J3, J4, J6

ONLY 3BAVD

L103, L106
C108, C109, C110, C120, C121, C122
Q101, Q102, Q103, Q104, Q107, Q108
R102, R103, R104, R105, R106
R121, R122, R123, R124, R133

	2 BAND	3 BAND
R126	560	3.3K
R127	10K	15K
C104	15P	12P
C124	4.7/50	1/50
C125	0.022	0.01

A
B
C
D
E
F
G
H

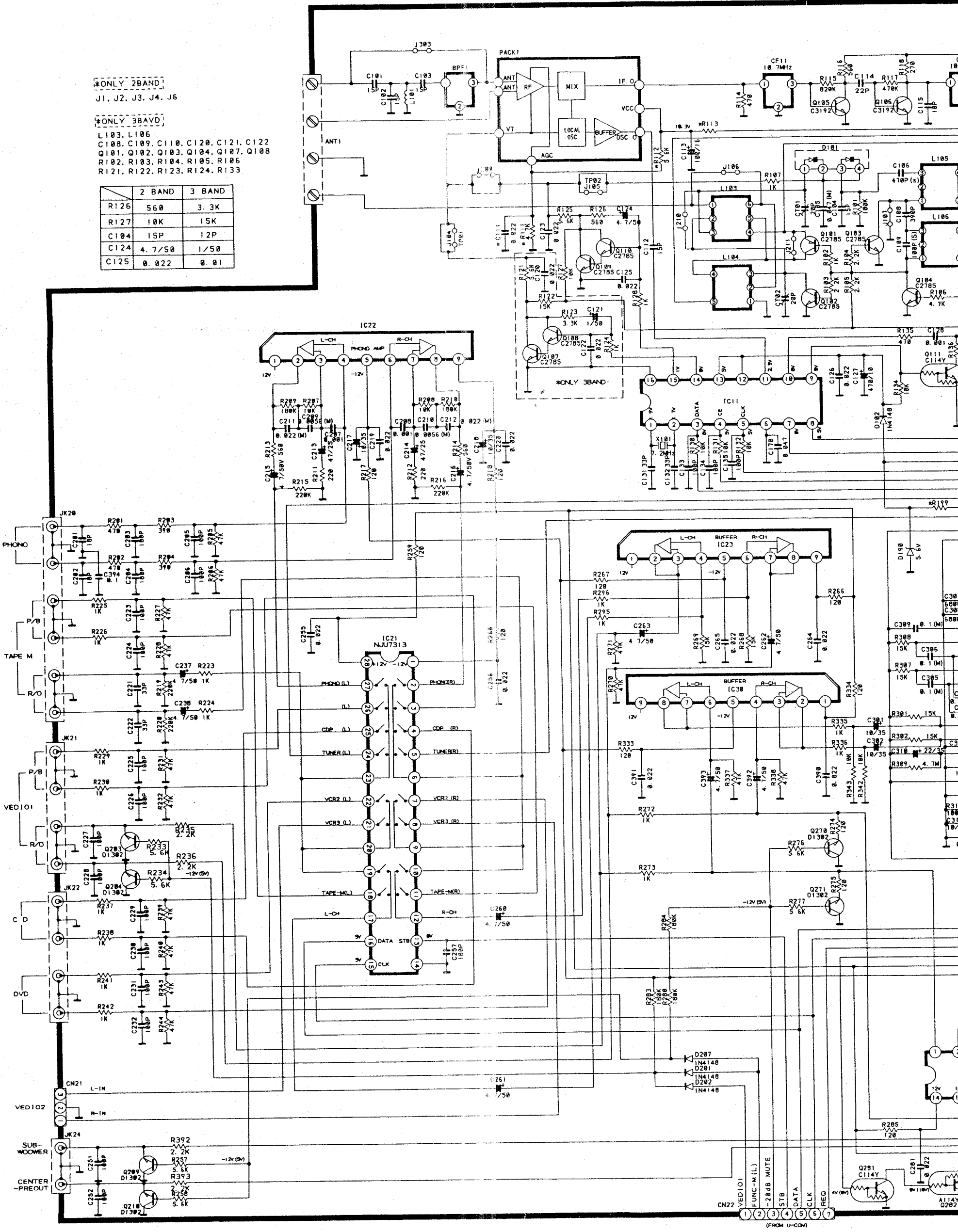

INSTRUCTIONS FOR SERVICE PERSONNEL
BEFORE RETURNING APPLIANCE TO THE CUSTOMER, MAKE LEAKAGE-CURRENT OR RESISTANCE MEASUREMENTS TO DETERMINE THAT EXPOSED PARTS ARE ACCEPTABLY INSULATED FROM THE SUPPLY CIRCUIT.

NOTES:
1. Resistor values are in ohms (k=kilo-ohms, M=megohms).
2. Capacitor values are in microfarads (p=picofarads).
3. Δ Parts marked with this sign are safety critical components. They must always be replaced with identical components refer to the appropriate parts list and ensure exact replacement.

CN22 (FROM U-COM)

TEAC BLOCK DIAGRAM AG-V8500/AG-V8060

1 2 3 4 5 6

A
B
C
D
E
F
G
H

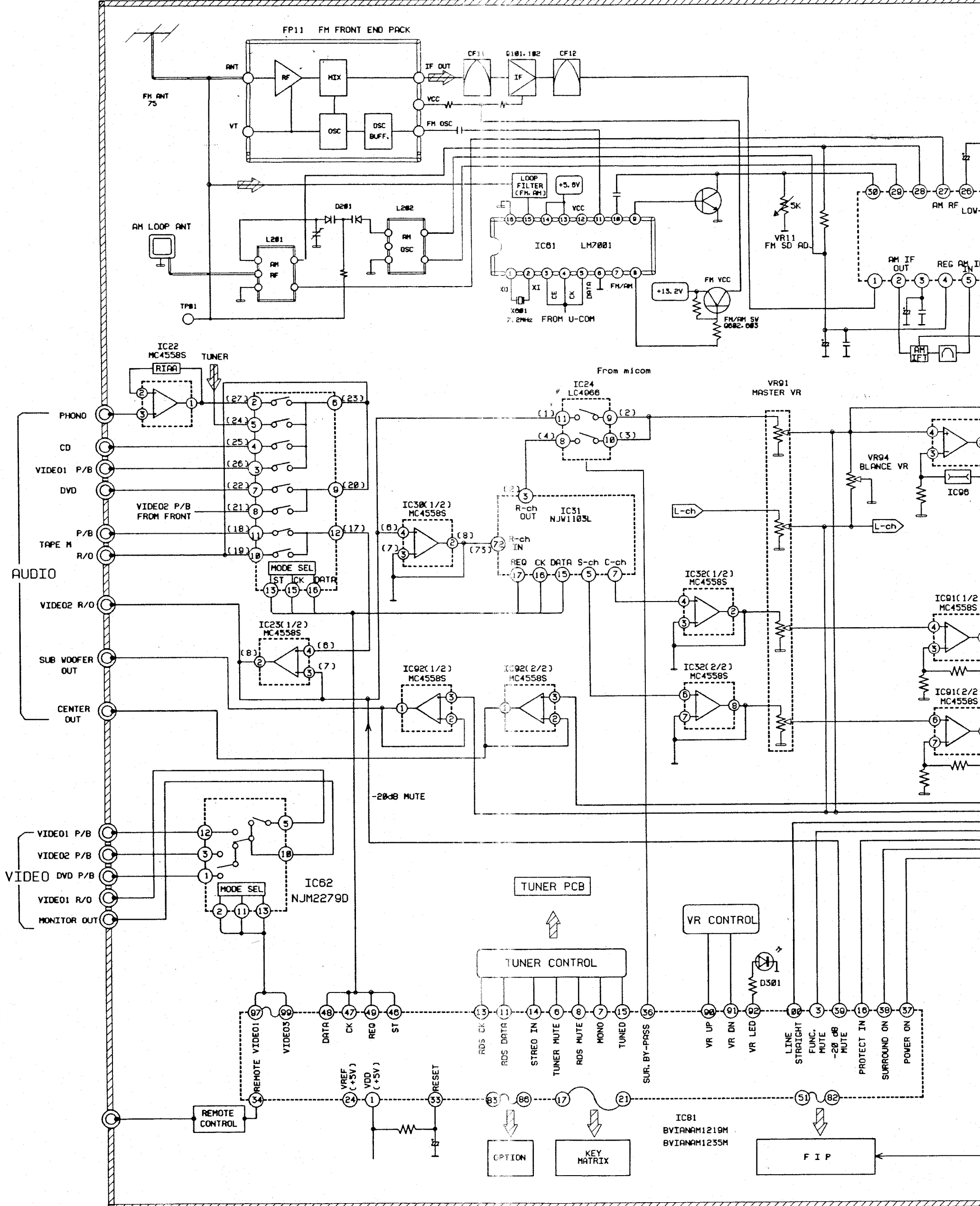

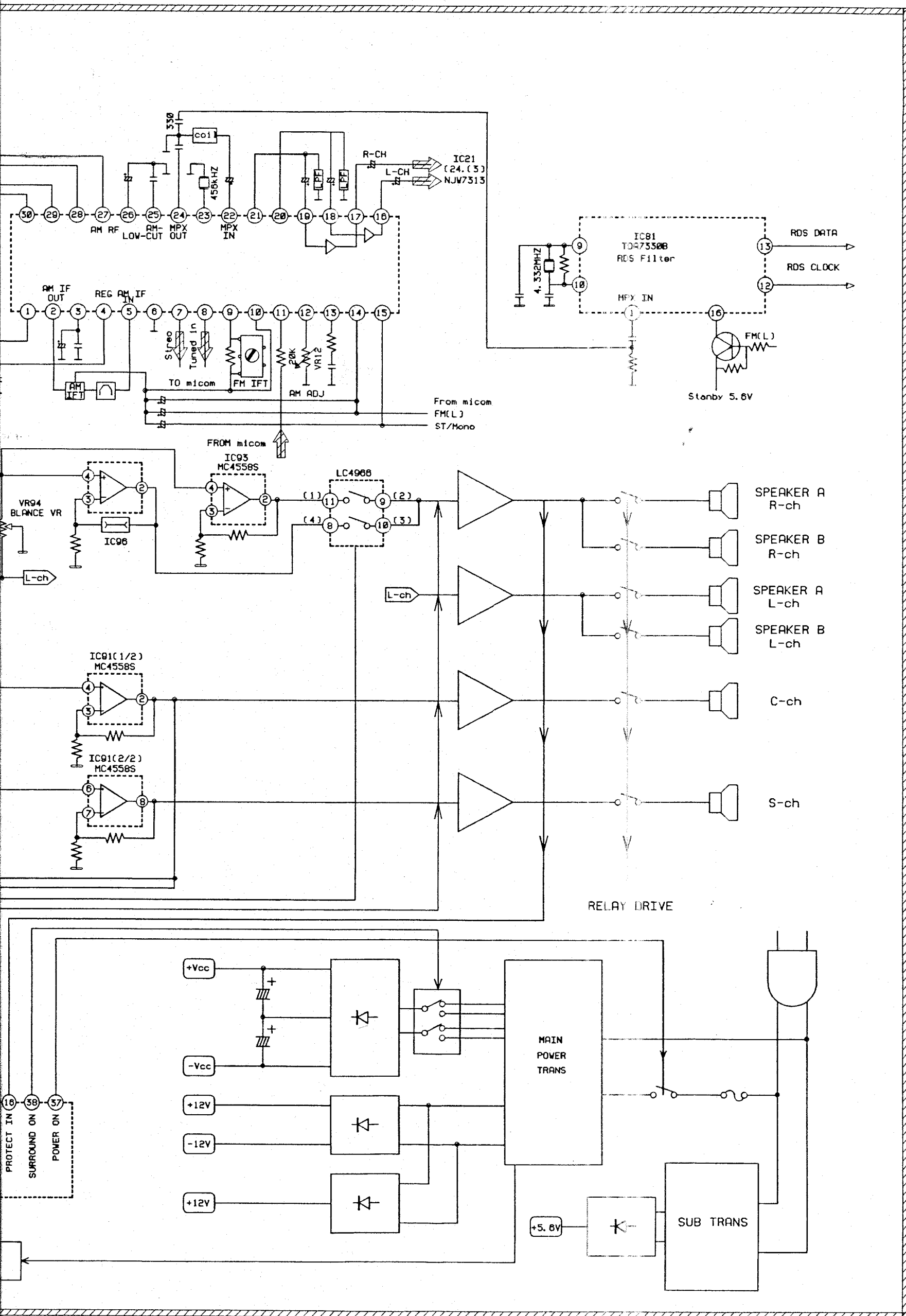

AG-V8500/AG-V8060

Audio/Video Surround Receiver

MAIN PCB ASSY

REF. NO.	PARTS NO.	DESCRIPTION
	9A06755700	MAIN PCB ASSY [US, C]
	9A06755710	MAIN PCB ASSY [SA]
	9A06755720	MAIN PCB ASSY [E, UK]
	9A06764100	PCB, MAIN
	9A05328200	HOLDER, FUSE
	△ 9A06765800	TRANS, SUB [US, C]
	△ 9A06769700	TRANS, SUB [SA]
	△ 9A06784900	TRANS, SUB [E, UK]
	9A06756400	BRACKET, PCB(A)
	9A06679200	TR SUPPORT
	9A06679000	MOTOR
	9A06678800	FAN
	9A06679300	H/S COVER
	9A06678900	FRAME FAN
	9A06768600	HEAT SINK
	9A06699900	SCREW
	9A01532600	SCREW, KTB3+6J
	9A01535800	SCREW, KTB3+8J
	9A05339200	SCREW, KTW3+8J
CN61	9A05329100	WAFER, MOLEX 5267-03A
CN63	9A05330300	WAFER, MOLEX 53014-0810
CN64	9A05329600	WAFER, MOLEX 5267-06A
CN65, 66	9A05328900	WAFER, MOLEX 5267-02A
CN67	9A05329300	WAFER, MOLEX 5267-04A
CN71	9A06250800	WAFER, MOLEX 5267-08A
CN72	9A06759300	WAFER
CN74	9A06674400	WAFER [US, C, SA]
CN74	9A06785000	WAFER [E, UK]
CN75	9A05329100	WAFER, MOLEX 5267-03A [SA]
C701, 702	△ 9A06759400	CE, 8200UF V 80V DC
C703, 704	△ 9A06226700	CE, 1000UF H 25V DC
C727, 729	△ 9A06226700	CE, 1000UF H 25V DC
C751	△ 9A06692300	CC, 4700PF M 250V
C754	△ 9A06769600	CE, 220UF 63V [US, C]
D401-404	9A06765100	DIODE, MTZJ27BT
D405-408	9A01390500	DIODE, 1N4148MT
D411, 412	9A01390500	DIODE, 1N4148MT
D501-504	9A06765100	DIODE, MTZJ27BT
D505, 506	9A01390500	DIODE, 1N4148MT
D507, 508	9A01390500	DIODE, 1N4148MT
D511, 512	9A01390500	DIODE, 1N4148MT
D701	△ 9A06759900	DIODE, KBU804F [US, C]
D703, 704	9A06765200	DIODE, MTZJ13BT
D705	9A06317000	DIODE, MTZJ30BT
D706, 707	9A06236200	DIODE, MTZJ6. 2BT
D708	9A06765200	DIODE, MTZJ13BT
D709	9A01390500	DIODE, 1N4148MT [US, C]
D710, 711	△ 9A05194600	DIODE, 1N4003SRT
D712	9A01390500	DIODE, 1N4148MT
D713, 714	9A05194600	DIODE, 1N4003SRT
D715-718	9A01390500	DIODE, 1N4148MT
D719-724	△ 9A05194600	DIODE, 1N4003SRT
D727-729	9A06765300	DIODE, MTZJ5. 6BT
D730	9A01390500	DIODE, 1N4148MT
D733-736	9A01390500	DIODE, 1N4148MT

MAIN PCB ASSY

REF. NO.	PARTS NO.	DESCRIPTION
ET01, 02	9A05333900	PLATE, EARTH
F701	△ 9A06756000	FUSE [US, C]
F701	△ 9A06784200	FUSE [E, UK]
F703, 704	△ 9A06760000	FUSE, LEAD [US, C]
IC61	9A06760100	IC, NJM4556AL
IC62	9A06760200	IC, NJM2279D
IC63	△ 9A06765400	IC, KIA78L12BPT
JK61	9A06760300	JACK, BOARD
JK71	9A01536100	TERMINAL, SPEAKER 8P
JK72	9A06677100	TERMINAL, SP [US, C, SA]
JK72	9A06785100	TERMINAL, SPEAKER [E, UK]
L401, 402	9A06760400	COIL, SPEAKER
L501, 502	9A06760400	COIL, SPEAKER
L701	9A06673700	COIL, AXAIL
Q401-408	9A06236700	TR, KTC3200GRT
Q409, 410	9A06676000	TR, KTD2058Y
Q411, 412	9A06765500	TR, KTA1275YT
Q413, 414	9A06765600	TR, KTC3228YT
Q415, 416	△ 9A06768700	TR, 2SC3856
Q417, 418	△ 9A06768800	TR, 2SA1492
Q421, 422	9A05197500	TR, KTD1302T
Q423, 424	9A03745000	TR, KSC2785YTA
Q425, 426	△ 9A06760500	TR, KTC4370AY
Q427, 428	△ 9A06760600	TR, KTA1659AY
Q501-508	9A06236700	TR, KTC3200GRT
Q509, 510	9A06676000	TR, KTD2058Y
Q511, 512	9A06765500	TR, KTA1275YT
Q513, 514	9A06765600	TR, KTC3228YT
Q515, 516	△ 9A06768900	TR, 2SC4468
Q517, 518	△ 9A06769000	TR, 2SA1695
Q521, 522	9A05197500	TR, KTD1302T
Q523, 524	9A03745000	TR, KSC2785YTA
Q525, 526	△ 9A06760500	TR, KTC4370AY
Q527, 528	△ 9A06760600	TR, KTA1659AY
Q601, 602	9A05197500	TR, KTD1302T
Q603, 604	9A03745000	TR, KSC2785YTA
Q607	9A05196400	TR, DTA114YST
Q608	9A03745100	TR, KSA1175YTA
Q701	9A05196500	TR, DTC114YST
Q702	△ 9A05196800	TR, KSC2316Y-SHTA
Q703	△ 9A05196700	TR, KSA916Y-SHTA
Q704	9A05197200	TR, KTA1271YT
Q705	9A05196500	TR, DTC114YST
Q706	△ 9A05196800	TR, KSC2316Y-SHTA
Q707	9A03747300	TR, KSB811YTA
Q708	△ 9A06676000	TR, KTD2058Y
Q709	9A05196700	TR, KSA916Y-SHTA
Q710	9A06067000	TR, DTC144TST
Q711	9A05196400	TR, DTA114YST
Q712-714	9A05196500	TR, DTC114YST
Q715	9A05196400	TR, DTA114YST
Q716-718	9A03745000	TR, KSC2785YTA
Q719, 720	9A05911500	TR, DTC114TST
Q721	9A06769800	TR, DTA114TST
Q722, 723	9A05196400	TR, DTA114YST

MAIN PCB ASSY

REF. NO.	PARTS NO.	DESCRIPTION
Q724	△ 9A06676000	TR, KTD2058Y [SA]
RY70	△ 9A05987100	RELAY, HR-CR7-DC12V
RY71	9A06677200	RELAY [US, C]
RY72-74	9A04879000	RELAY, OSA-SS-212DM3
R435-438	△ 9A06760700	R, CEMENT 0.27 J 5W
R445, 446	△ 9A05979000	R, 4.7-OHM 2W
R447, 448	△ 9A05338000	R, METAL 10 1W
R457, 458	△ 9A06760800	R, METAL 4.7K J 1W
R535-538	△ 9A06760700	R, CEMENT 0.27 J 5W
R545, 546	△ 9A05979000	R, 4.7-OHM 2W
R547, 548	△ 9A05338000	R, METAL 10 1W
R557, 558	△ 9A06760800	R, METAL 4.7K J 1W
R721, 722	△ 9A06760900	R, FUSE 0.47 J 1W [US, C]
R737	△ 9A06761000	R, CARBON 3.3M K 1/2W [US, C]
R740, 741	△ 9A06761100	R, CARBON 270 J 1/2W
R752	△ 9A06760900	R, FUSE 0.47 J 1W
TH01	9A06675400	THERMISTER

FRONT PCB ASSY

REF. NO.	PARTS NO.	DESCRIPTION
	9A06754700	FRONT PCB ASSY [US, C]
	9A06754710	FRONT PCB ASSY [SA]
	9A06754730	FRONT PCB ASSY [E]
	9A06754740	FRONT PCB ASSY [UK]
	9A06762800	PCB, FRONT
BK81, 82	9A05961600	BRACKET, FLT
BK91	9A06252900	BRACKET, PCB
BK93	9A06756400	BRACKET, PCB(A)
BK94	9A06756400	BRACKET, PCB(A) [UK]
CN62	9A05892600	WAFER (9P)
CN81	9A06538200	WAFER [SA, E]
CN81	9A06538300	WAFER [US, C]
CN91	9A05330000	WAFER, MOLEX 5267-07A
CN93	9A05894700	WAFER (5P)
CN96	9A05356400	WAFER, MOLEX 53014-0510
CN97	9A06757700	WAFER
CN99	9A06769100	WAFER [SA]
C990	△ 9A06784600	CC, 2200PF M D 50V [E, UK]
D801-804	9A05195000	LED, RED SLR342VCF02
D805-807	9A01390500	DIODE, 1N4148MT
FIP1	9A06757800	F. I. P
F901	9A05328200	HOLDER, FUSE [US, C, SA, E]
F901	△ 9A05990700	FUSE, F2.5A [E]
F901	△ 9A06756100	FUSE [US, C, SA]
F902	△ 9A06537400	FUSE [SA]
IC81	9A06763800	IC, ANAM1219M [US, C, SA]
IC81	9A06786000	IC, TMP87PM78F [E, UK]
IC82	9A06757900	IC, PNA4612M00HB
IC91-94	9A05195800	IC, MC4558S
IC95	9A05971200	IC, LC4966

FRONT PCB ASSY

REF. NO.	PARTS NO.	DESCRIPTION
IC96	9A05195800	IC, MC4558S
JK91	9A06758000	JACK, HEAD PHONE
JK92-94	9A06758100	JACK, VCR
L901	9A06786100	INDUCTOR, KLQ330J405T [E, UK]
OL91	△ 9A05895700	OUTLET, AC [E]
OL92	△ 9A06224300	OUTLET [US, C, SA]
Q801-803	9A05196400	TR, DTA114YST
Q805, 806	9A03747300	TR, KSB811YTA
Q807, 808	9A03811700	TR, KSD1021YTA
Q809	9A05196400	TR, DTA114YST
Q810	9A05196500	TR, DTC114YST
Q811	9A03747300	TR, KSB811YTA
Q812-816	9A05196500	TR, DTC114YST
Q817	9A05196400	TR, DTA114YST
Q818-820	9A05196500	TR, DTC114YST [US, C, SA]
Q821	9A03745100	TR, KSA1175YTA [US, C, SA]
Q901	9A05196500	TR, DTC114YST
Q902	9A05196400	TR, DTA114YST
Q903	9A05196500	TR, DTC114YST
SW91	9A05385600	SW, PUSH(VERTICAL)
SW92	△ 9A05986500	SW, SLIDE [SA]
SW93	△ 9A06784700	SW, PUSH(MOMS) [E, UK]
S801-840	9A06671200	SW, TACT BST1A014ZT
T901, 902	9A06012400	TERMINAL, LUG [UK]
VR91	9A06758300	VOLUME, MOTOR
VR92, 93	9A06758400	RES, VARIABLE
VR94	9A06758500	RES, VARIABLE
X801	9A06758600	CRYSTAL

TUNER PCB ASSY

REF. NO.	PARTS NO.	DESCRIPTION
	9A06761200	TUNER PCB ASSY [US, C, SA]
	9A06761230	TUNER PCB ASSY [E, UK]
	9A06766000	TUNER PCB
	9A06259400	TERMINAL, ANT 75/300 [US, C, SA]
	9A04875900	TERMINAL, ANT [E, UK]
	9A06761400	TUNER, PACK [US, C, SA]
	9A05938700	TUNER, PACK [E, UK]
BPF1	9A05195100	BPF, BPMB8 [E, UK]
CF11, 12	9A06544600	CERAMIC FILTER
CF21	9A05939400	I.F.T, AM
CF22	9A06761500	CERAMIC FILTER
CN10	9A05331000	WAFER, MOLEX 53014-1210 [E, UK]
CN10	9A05330700	WAFER, MOLEX 53014-1010 [US, C, SA]
CN21	9A05329100	WAFER, MOLEX 5267-03A
CN22	9A05330000	WAFER, MOLEX 5267-07A
CN23	9A05991400	WAFER
CN24	9A05329600	WAFER, MOLEX 5267-06A
CT01	9A01405900	C, VARIABLE 20PF
D101	9A06767400	DIODE, SVC342LT
D102	9A01390500	DIODE, 1N4148MT

TUNER PCB ASSY

REF. NO.	PARTS NO.	DESCRIPTION
D180	9A01390500	DIODE, 1N4148MT [E, UK]
D190	9A06765300	DIODE, MTZJ5. 6BT
D201, 202	9A01390500	DIODE, 1N4148MT
D207	9A01390500	DIODE, 1N4148MT
D301	9A06765300	DIODE, MTZJ5. 6BT
D302	9A01390500	DIODE, 1N4148MT
IC11	9A04323300	IC, LM7001
IC12	9A06767500	IC, LA1836M
IC18	9A06786600	IC, TDA7330BD [E, UK]
IC21	9A06761700	IC, NJU7313L
IC22, 23	9A05195800	IC, MC4558S
IC24	9A05971200	IC, LC4966
IC30, 32	9A05195800	IC, MC4558S
IC31	9A06767600	IC, NJW1103F
JK20	9A06761800	TERMINAL, IN/OUT
JK21, 22	9A06761900	JACK, IN/OUT
JK24	9A06762000	JACK, BOARD
L101	9A04875000	COIL, FILTER [E, UK]
L104	9A06259900	COIL, AM ANT2
L105	9A05332500	COIL, AM OSC
L107	9A05332600	COIL, A183KWCZ [E, UK]
L108, 109	9A04883400	COIL
L301	9A06767700	COIL, AXAIL
L302	9A06673700	COIL, AXAIL
Q105, 106	9A05197300	TR, KTC31920T
Q109, 110	9A03745000	TR, KSC2785YTA
Q111	9A05196500	TR, DTC114YST
Q112	9A05196400	TR, DTA114YST
Q113, 114	9A05196500	TR, DTC114YST
Q181	9A05196400	TR, DTA114YST [E, UK]
Q203, 204	9A05197500	TR, KTD1302T
Q209, 210	9A05197500	TR, KTD1302T
Q270, 271	9A05197500	TR, KTD1302T
Q280, 281	9A05196500	TR, DTC114YST
Q282	9A05196400	TR, DTA114YST
Q301	9A05197500	TR, KTD1302T
S101	9A04882400	SW, TACT
T101	9A06762200	I FT, FM
VR11	9A05317400	VR, SEMI-FIXED
VR12	9A05317700	VR, SEMI-FIXED
X101	9A06762300	CRYSTAL
X102	9A06762400	RESONATOR, CERAMIC
X103	9A06762500	FILTER, CERAMIC
X180	9A06785200	CRYSTAL [E, UK]
X181	9A06762600	RESONATOR, CERAMIC

POWER PCB ASSY

REF. NO.	PARTS NO.	DESCRIPTION
	9A06773600	POWER PCB ASSY [SA]
	9A06785410	POWER PCB ASSY [E, UK]
	9A06786700	PCB, POWER
	9A05328200	HOLDER, FUSE
D701	△ 9A06759900	DIODE, KBU804F
D709	9A01390600	DIODE, 1N4148T
F703, 704	△ 9A06769200	FUSE [SA]
F703, 704	△ 9A06784300	FUSE [E, UK]
RY71	9A06677200	RELAY
R721, 722	△ 9A06760900	R, FUSE 0. 47 J 1W

INCLUDED ACCESSORIES

REF. NO.	PARTS NO.	DESCRIPTION
	9A06555300	OWNER'S MANUAL, E/F [US, C] AG-V8500
	9A06555400	OWNER'S MANUAL, MULTI [E, UK] AG-V8500
	9A06555600	OWNER'S MANUAL, E/F AG-V8060
	9A06762700	REMOCON, UR-410
	9A06261100	ANT, AM LOOP [US, C, SA]
	9A06261200	ANT, FM T [US, C, SA]
	9A05338400	AM LOOP ANT ASSY [E, UK]
	9A04883100	ANT, FM WIRE [E, UK]