

TEAC

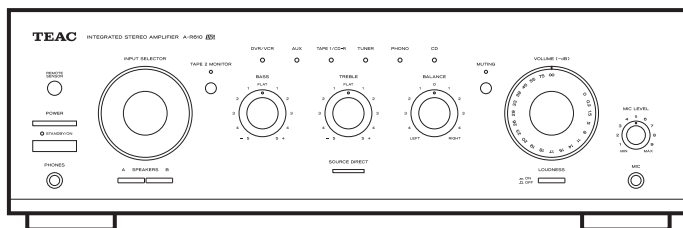

SERVICE MANUAL

Simplified
簡易版

A-R610

INTEGRATED STEREO AMPLIFIER

CONTENTS

1. SPECIFICATIONS	2
2. EXPLODED VIEWS AND PARTS LISTS	3
3. PC BOARDS	4
4. INCLUDED ACCESSORIES	6

NOTES

- PC boards shown are viewed from parts side.
- The parts with no reference number or no parts number in the exploded views are not supplied.
- As regards the resistors and capacitors, refer to the circuit diagrams supplied prior to this manual.
- ⚠ Parts marked with this sign are safety critical components. They must be replaced with designated components.
- Destination of product is expressed by [] mark and ensure exact replacement: [EUR] - Europe, [UK] - UK

1. SPECIFICATIONS

Amplifier Section

Continuous Power Output	120 W+120 W RMS (1 kHz, 4 ohms, 0.5 %)
	90 W+90 W (1 kHz, 8 ohms, 0.5 %)
Total Harmonic Distortion	0.02% (1 kHz, 8 ohms, 60W)
Input Sensitivity/Impedance	PHONO: 2.8 mV/47 k ohms
	LINE*: 180 mV/47 k ohms
Signal-to-Noise Ratio (IHF-A)	PHONO: 65 dB
	LINE*: 90 dB
Output Level/Impedance	TAPE: 150 mV/3.3 k ohms
Frequency Response	PHONO: 20 to 20,000 Hz, ± 1 dB (RIAA)
	LINE*: 5 to 80,000 Hz, (SOURCE DIRECT, 1 W)
Tone Control	BASS: ± 10 dB at 100 Hz
	TREBLE: ± 10 dB at 10 kHz
Muting	-20 dB

General

Power Requirements	230 V AC, 50 Hz
Power consumption	300 W (Standby: 1.1 W)
Dimensions (W x H x D)	430 x 142 x 355 mm
Weight (net)	9.7 kg

Standard Accessories

Remote Control Unit (UR-592B) x 1
Battery (AAA, R03, UM-4) x 2
Owner's Manual x 1
Warranty Card x 1

*: LINE means TUNER, CD, DVR/VCR, AUX, TAPE1/CD-R, TAPE2.

3. PC BOARDS

MAIN PCB

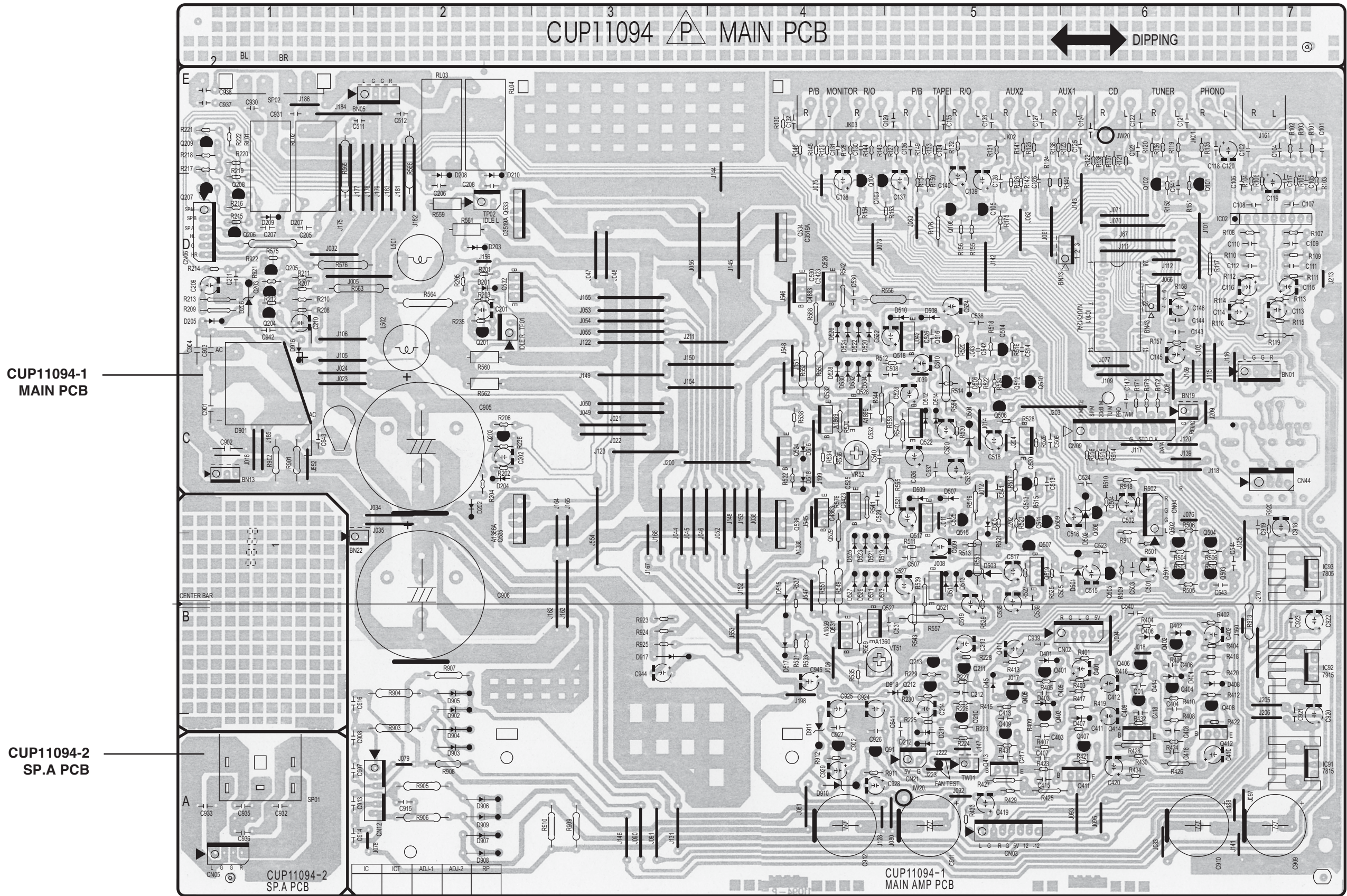

Consult the BOM.xls for detail of individual parts.

SUB PCB

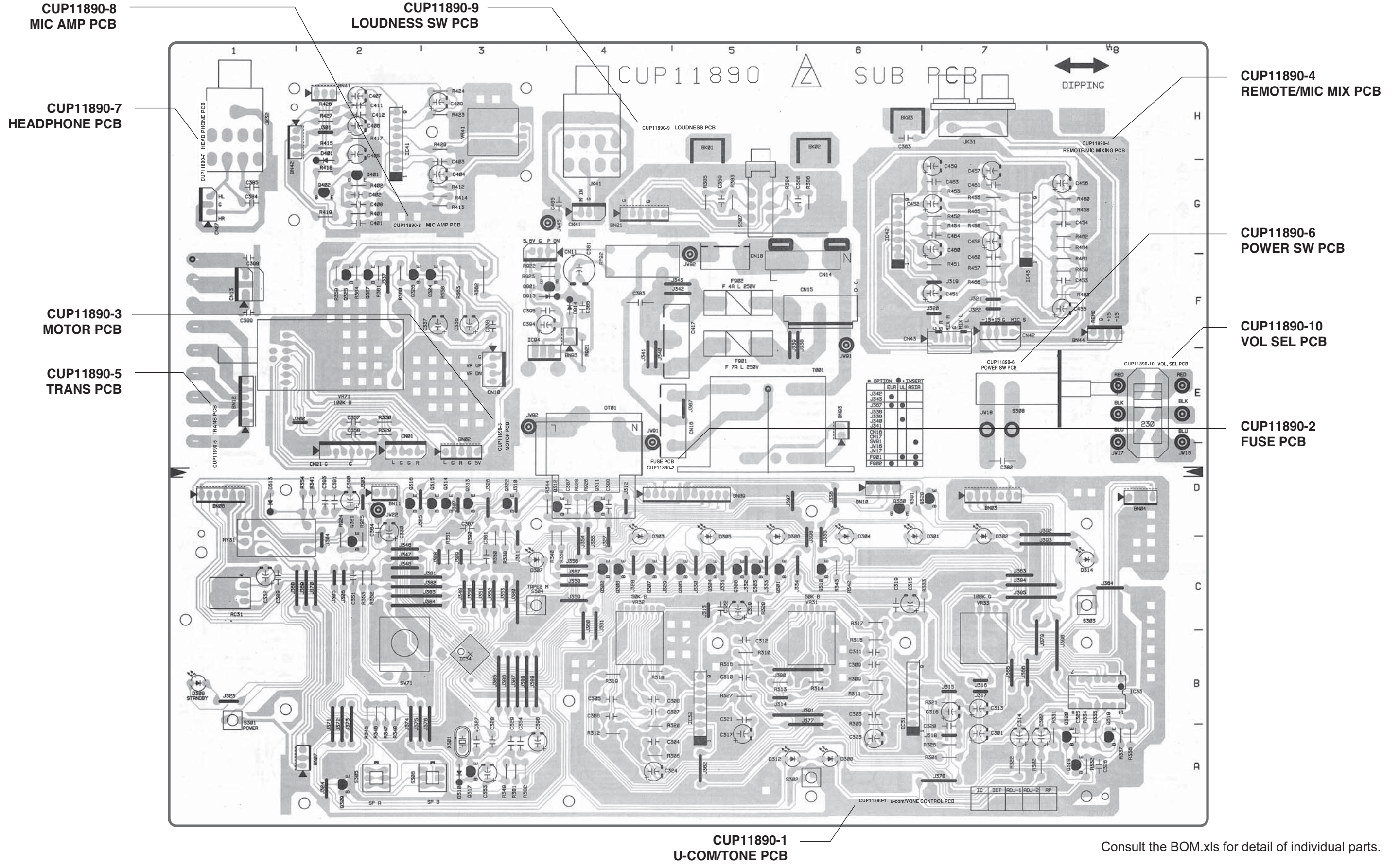

Consult the BOM.xls for detail of individual parts.

4. INCLUDED ACCESSORIES

REF. NO.	PARTS NO.	DESCRIPTION	REMARKS
	CQX1A484W	OWNER'S MANUAL	
	CABR03PPB	BATTERY , AAA 2 PCS IN PACK	
	CARTAR600Y	REMOTE CONTROL UNIT UR-592B	

REMOTE CONTROL UNIT UR-592B

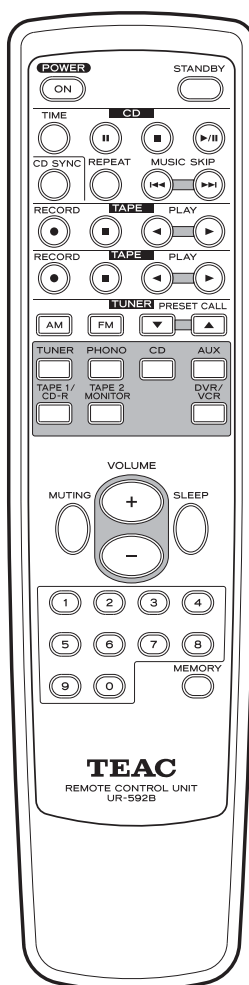

A-R610

TEAC

TEAC CORPORATION 1-47,Ochiai, Tamashi, Tokyo 206-8530, Japan Phone: (042) 356-9155

TEAC AMERICA, INC. 7733 Telegraph Road, Montebello, California 90640 Phone: (323) 726-0303

TEAC CANADA LTD. 5939 Wallace Street, Mississauga, Ontario L4Z 1Z8, Canada Phone: (905) 890-8008

TEAC MEXICO, S.A. De C.V Rio Churubusco 364, Colonia Del Carmen, Delegación Coyoacán, CP 04100, México DF, México Phone: (5255) 5010-6000

TEAC UK LIMITED Unit 19 & 20, The Courtyards, Hatters Lane, Watford, Hertfordshire, WD18 8TE, U.K. Phone: (0845) 130-2511

TEAC EUROPE GmbH Bahnstrasse 12, 65205 Wiesbaden-Erbenheim, Germany Phone: 0611-71580

TEAC

SCHEMATIC DIAGRAMS

CONTENTS

Wiring Diagram	2
Block Diagram	3
MAIN PCB	4
SUB PCB	5

A-R610
Integrated Stereo Amplifier

1 st Issue; September 2009

TEAC WIRING DIAGRAM A-R610

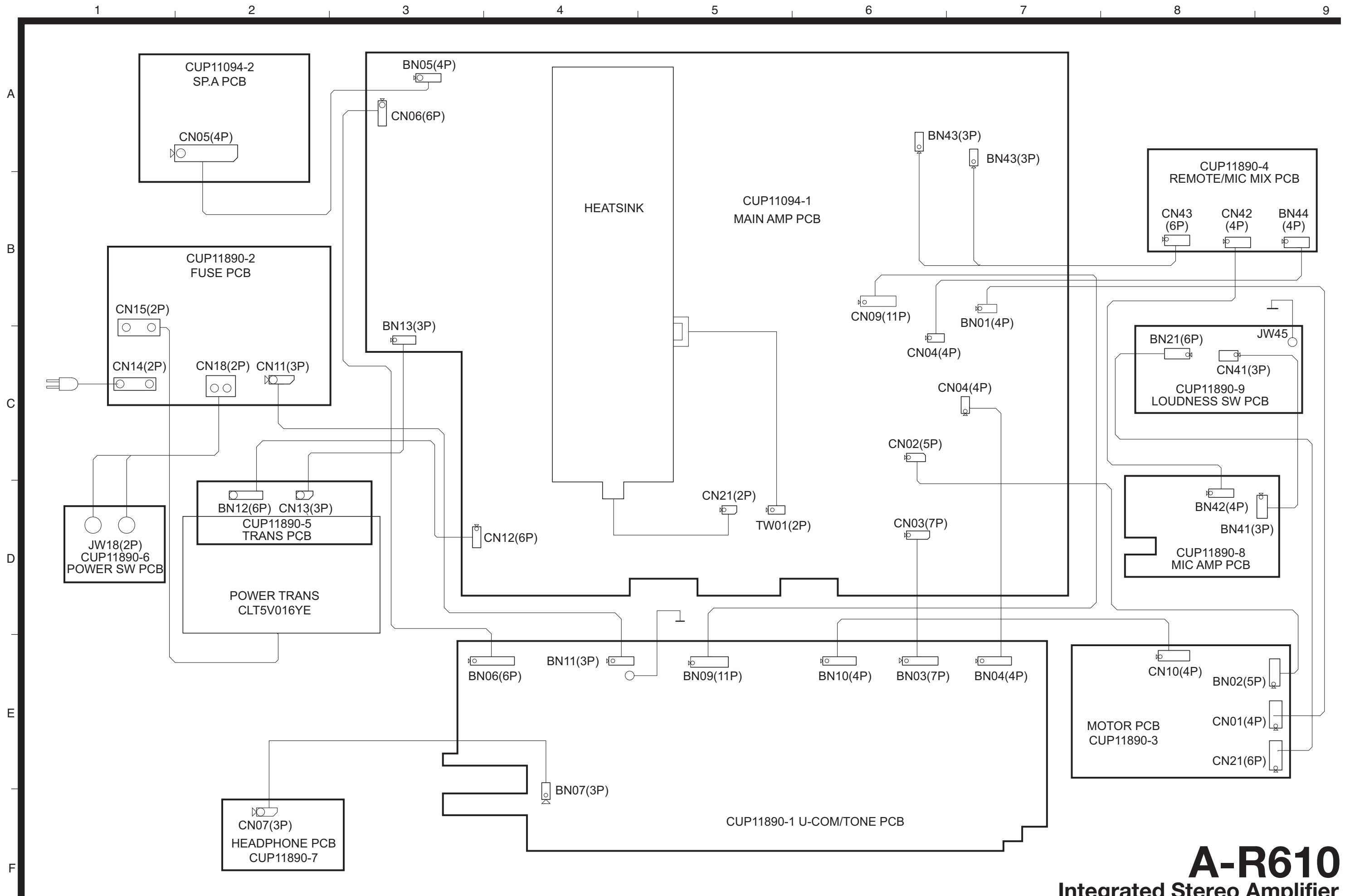

TEAC BLOCK DIAGRAM A-R610

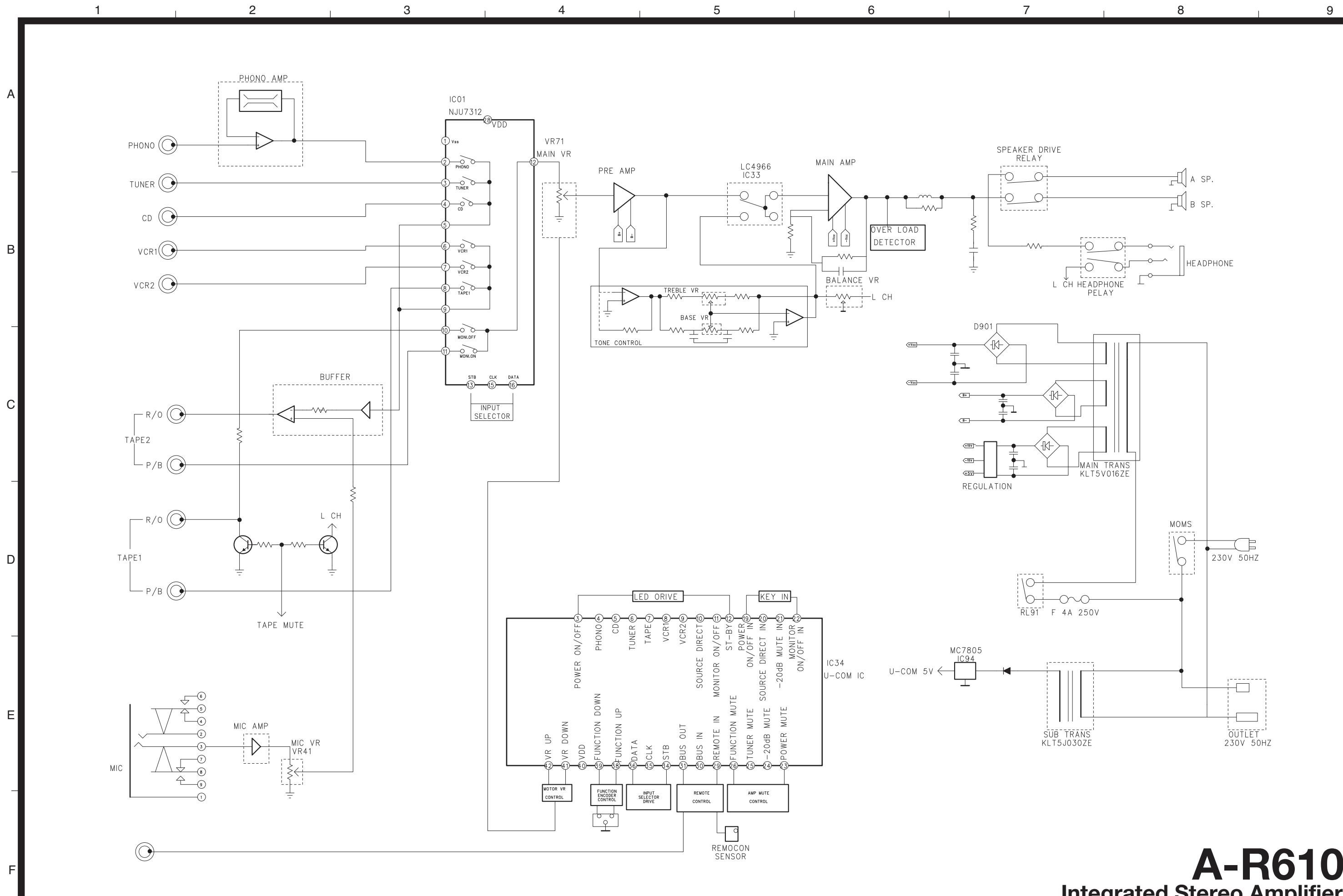

A-R610 Integrated Stereo Amplifier

1 st Issue; September 2009

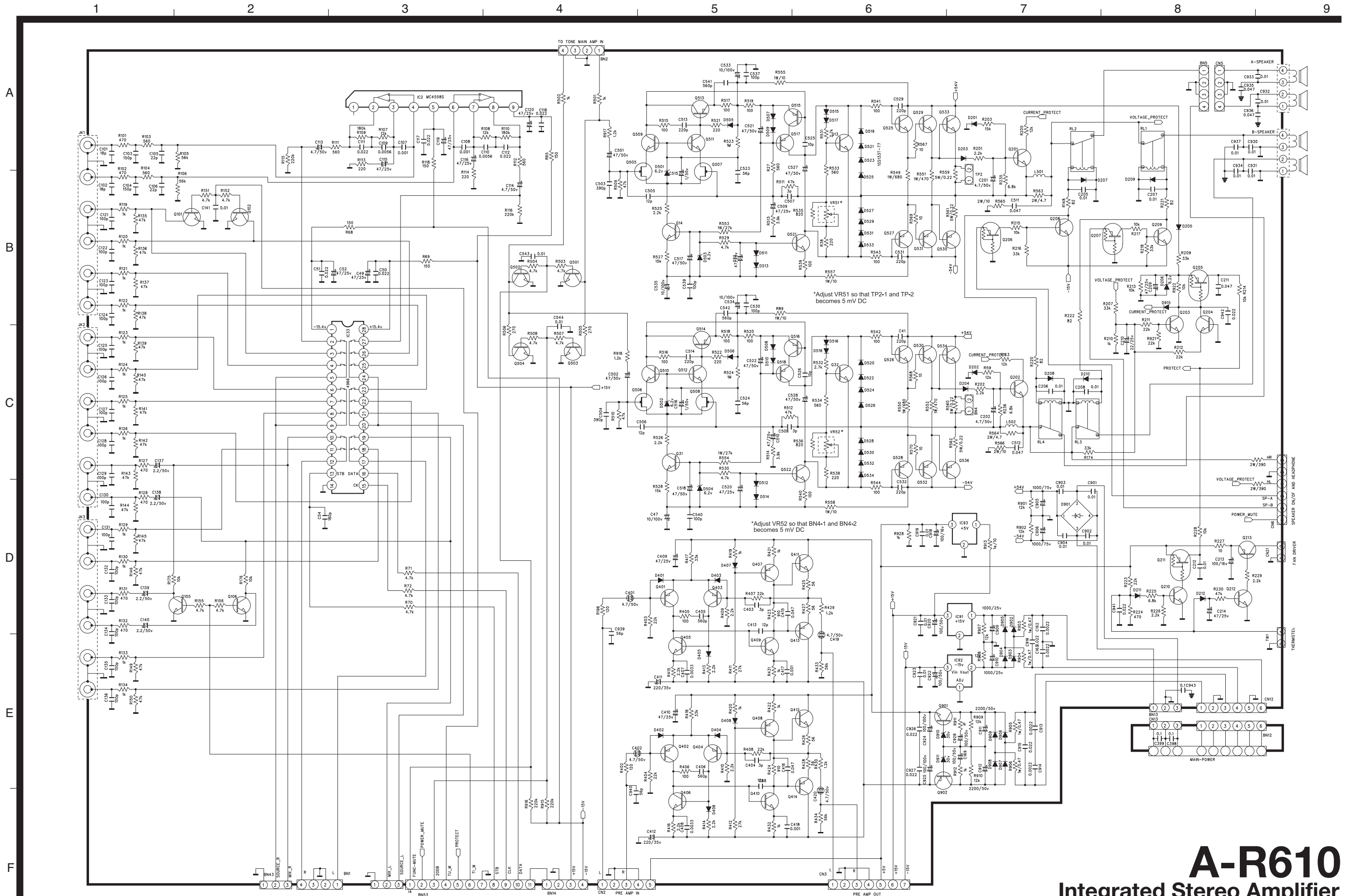

A-R610
Integrated Stereo Amplifier

1st Issue; September 2009

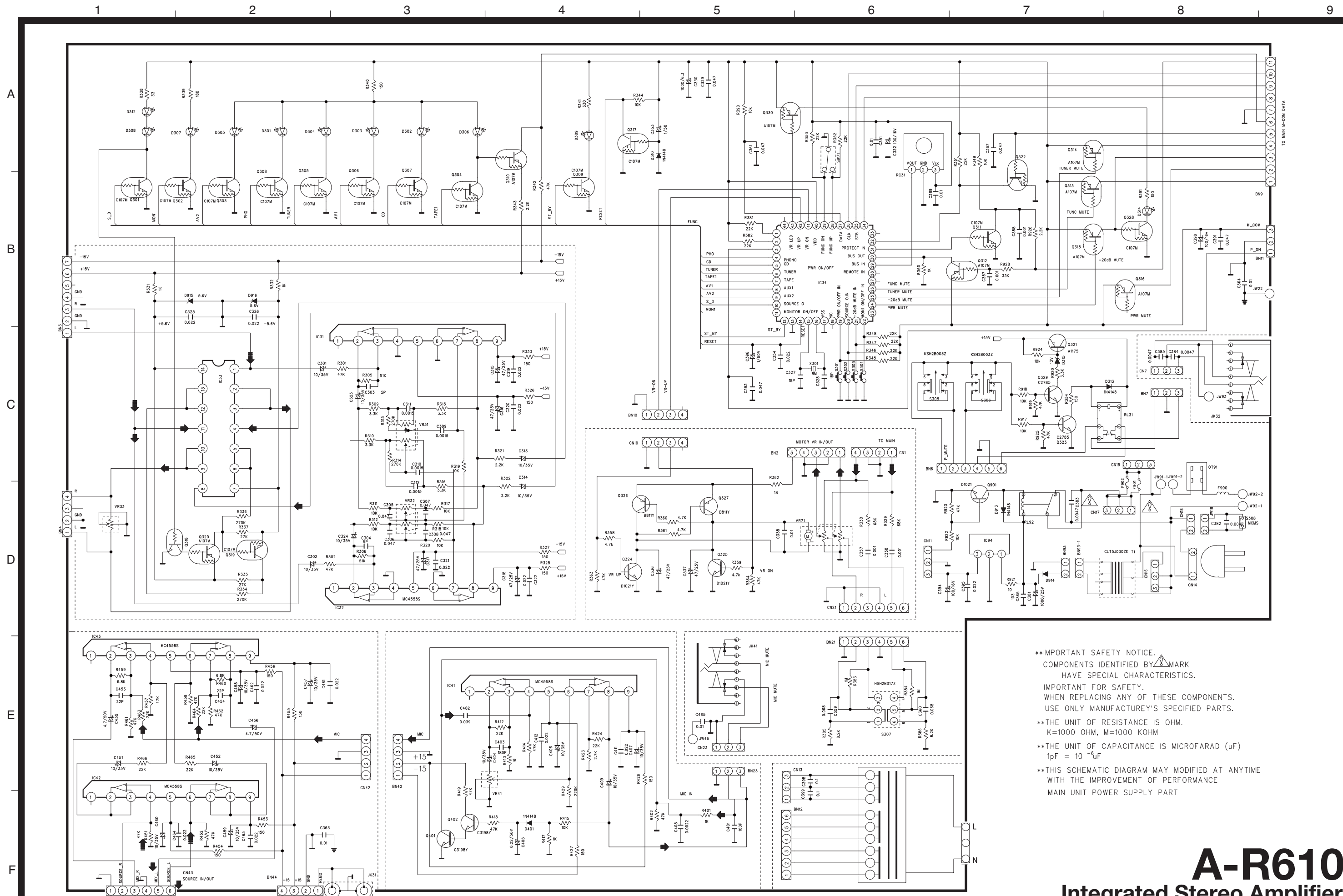

Integrated Stereo Amplifier, A-R610

LEVEL	PART No.	DESCRIPTION	
1	A-R610EURSET	SET,AMPLIFIER	
.2	CGWAR610EUR	FRONT PANEL ASS'Y	
..3	CBC1A095	KNOB , LOUDNESS	
..3	CBC1A114	KNOB , SPEAKER	
..3	CBC1A115	KNOB , LOUDNESS(PUSH)	
..3	CBN1A079YK66	KNOB , ROTARY	
..3	CBN2A052Y	KNOB,ROTARY	
..3	CBT1A603	KNOB , TACT	
..3	CBT1A604	KNOB , POWER	
..3	CBT1A605	KNOB , DIRECT	
..3	CGB1A165H8	BADGE , TEAC	
..3	CGL1A109	INDICATOR , FUNCTION	
..3	CGL1A162	INDICATOR , FUNCTION	
..3	CGR2A154	ORNAMENT , REMOTE	
..3	CGW3A245XH1	PANEL , FRONT(A-R610)	A-R610
..3	CMD1A355	BRACKET , TOP	
..3	CMD1A363	BRACKET , POWER	
..3	CMK1A019	BRACKET , VOLUME	
..3	CNW1A036	WASHER	
..3	CNW1A037	WASHER	
..3	COP11890B	SUB PCB ASS'Y	
...4	CIP11890B	SUB PCB AUTO ASS'Y	
....5	CUP11890Y	PCB , MAIN (A-R610 , 330*247 ,FR-	A-R610 , 330*247 ,FR-1
....5	CCEA1VH100T	CAP , ELECT	10UF 35V
....5	CCEA1VH100T	CAP , ELECT	10UF 35V
....5	CCCT1H050CC	CAP , CERAMIC	5PF 50V C
....5	CCCT1H050CC	CAP , CERAMIC	5PF 50V C
....5	HCQI1H473JZT	CAP , MYLAR	0.047UF 50V J
....5	HCQI1H473JZT	CAP , MYLAR	0.047UF 50V J
....5	HCQI1H473JZT	CAP , MYLAR	0.047UF 50V J
....5	HCQI1H473JZT	CAP , MYLAR	0.047UF 50V J
....5	HCQI1H152JZT	CAP , MYLAR	1500PF 50V J
....5	HCQI1H152JZT	CAP , MYLAR	1500PF 50V J
....5	HCQI1H152JZT	CAP , MYLAR	1500PF 50V J
....5	HCQI1H152JZT	CAP , MYLAR	1500PF 50V J
....5	CCEA1VH100T	CAP , ELECT	10UF 35V
....5	CCEA1VH100T	CAP , ELECT	10UF 35V
....5	CCEA1EH470T	CAP , ELECT	47UF 25V
....5	CCEA1EH470T	CAP , ELECT	47UF 25V
....5	CCEA1EH470T	CAP , ELECT	47UF 25V
....5	CCEA1EH470T	CAP , ELECT	47UF 25V

....5	CCBS1H223ZFT	CAP , CERAMIC(22000PF/50V)	CH UP025 F223Z-A-B J
....5	CCBS1H223ZFT	CAP , CERAMIC(22000PF/50V)	CH UP025 F223Z-A-B J
....5	CCBS1H223ZFT	CAP , CERAMIC(22000PF/50V)	CH UP025 F223Z-A-B J
....5	CCBS1H223ZFT	CAP , CERAMIC(22000PF/50V)	CH UP025 F223Z-A-B J
....5	CCEA1VH100T	CAP , ELECT	10UF 35V
....5	CCEA1VH100T	CAP , ELECT	10UF 35V
....5	CCBS1H223ZFT	CAP , CERAMIC(22000PF/50V)	CH UP025 F223Z-A-B J
....5	CCBS1H223ZFT	CAP , CERAMIC(22000PF/50V)	CH UP025 F223Z-A-B J
....5	CCCT1H180JC	CAP , CERAMIC	18PF 50V J
....5	CCCT1H180JC	CAP , CERAMIC	18PF 50V J
....5	CCBS1H473ZFT	CAP , CERAMIC(47000PF/50V)	CH UP025 F473Z-A-B J
....5	CCEA0JH102T	CAP , ELECT	1000UF 6.3V
....5	CCEA1CH101T	CAP , ELECT	100UF 16V
....5	CCEA1EH470T	CAP , ELECT	47UF 25V
....5	CCEA1EH470T	CAP , ELECT	47UF 25V
....5	HCQI1H103JZT	CAP , MYLAR	0.01UF 50V J
....5	CCBS1H103ZFT	CAP , CERAMIC	0.01UF 50V Z
....5	CCEA1HH1R0T	CAP , ELECT	1UF 50V
....5	CCBS1H223ZFT	CAP , CERAMIC(22000PF/50V)	CH UP025 F223Z-A-B J
....5	CCBS1H102KBT	CAP , CERAMIC(1000PF/50V)	CH UP025 B102K-A-B Z
....5	CCBS1H102KBT	CAP , CERAMIC(1000PF/50V)	CH UP025 B102K-A-B Z
....5	HCQI1H683JZT	CAP , MYLAR	0.068UF 50V J
....5	HCQI1H683JZT	CAP , MYLAR	0.068UF 50V J
....5	CCBS1H473ZFT	CAP , CERAMIC(47000PF/50V)	CH UP025 F473Z-A-B J
....5	CCBS1H103ZFT	CAP , CERAMIC	0.01UF 50V Z
....5	CCBS1H103ZFT	CAP , CERAMIC	0.01UF 50V Z
....5	CCFT1H103ZF	CAP , CERAMIC	0.01UF 50V Z
....5	CCBS1H473ZFT	CAP , CERAMIC(47000PF/50V)	CH UP025 F473Z-A-B J
....5	CCBS1C472MX1	CAP , CERAMIC(4700PF/16V)	CH EP025 B472M-A-B J
....5	CCBS1C472MX1	CAP , CERAMIC(4700PF/16V)	CH EP025 B472M-A-B J
....5	CCBS1H102KBT	CAP , CERAMIC(1000PF/50V)	CH UP025 B102K-A-B Z
....5	CCBS1H102KBT	CAP , CERAMIC(1000PF/50V)	CH UP025 B102K-A-B Z
....5	CCBS1H103ZFT	CAP , CERAMIC	0.01UF 50V Z
....5	CCEA1CH101T	CAP , ELECT	100UF 16V
....5	CCBS1H473ZFT	CAP , CERAMIC(47000PF/50V)	CH UP025 F473Z-A-B J
....5	CCBS1H473ZFT	CAP , CERAMIC(47000PF/50V)	CH UP025 F473Z-A-B J
....5	CCEA1CH101T	CAP , ELECT	100UF 16V
....5	CCBS1H223ZFT	CAP , CERAMIC(22000PF/50V)	CH UP025 F223Z-A-B J
....5	CCEA1HH1R0T	CAP , ELECT	1UF 50V
....5	HCQI1H104JZT	CAP , MYLAR	0.1UF 50V J
....5	HCQI1H104JZT	CAP , MYLAR	0.1UF 50V J
....5	CCBS1H101KBT	CAP , CERAMIC(100PF/50V)	CH UP025 B101K-A-B Z
....5	HCQI1H393JZT	CAP , MYLAR	0.039UF 50V J
....5	CCBS1H181KBT	CAP , CERAMIC(180PF/50V)	CH UP025 B181K-A-B Z
....5	CCEA1VH100T	CAP , ELECT	10UF 35V
....5	CCEA1HHR22T	CAP , ELECT	0.22UF 50V
....5	CCEA1VH100T	CAP , ELECT	10UF 35V
....5	CCEA1VH100T	CAP , ELECT	10UF 35V

....5	HVTKRC107MT	T.R	KRC107M
....5	HVTKRA107MT	T.R	KRA107M
....5	HVTKRC107MT	T.R	KRC107M
....5	HVTKRA107MT	T.R	KRA107M
....5	HVTKRA104MT	T.R	KRA104M
....5	HVTKRA104MT	T.R	KRA104M
....5	HVTKRA104MT	T.R	KRA104M
....5	HVTKRA104MT	T.R	KRA104M
....5	HVTKRC107MT	T.R	KRC107M
....5	HVTKRC114MT	T.R	KTC114M
....5	HVTKRC107MT	T.R	KRC107M
....5	HVTKRA107MT	T.R	KRA107M
....5	HVTKTA1267YT	T.R	KTA1267Y
....5	HVTKRC107MT	T.R	KRC107M
....5	HVTKTC3199YT	T.R	KTC3199Y
....5	CVTKTC3204YT	T.R , KTC3204Y-AP/P(TO-92M)	
....5	CVTKTC3204YT	T.R , KTC3204Y-AP/P(TO-92M)	
....5	CVTKTA1272YT	T.R , KTA1272Y-AP/P(TO-92M)	
....5	CVTKTA1272YT	T.R , KTA1272Y-AP/P(TO-92M)	
....5	HVTKRC107MT	T.R	KRC107M
....5	HVTKTC3199YT	T.R	KTC3199Y
....5	HVTKRA107MT	T.R	KRA107M
....5	HVTKTC3198YT	T.R	KTC3198Y
....5	HVTKTC3198YT	T.R	KTC3198Y
....5	CVTKTC3204YT	T.R , KTC3204Y-AP/P(TO-92M)	
....5	CRD20TJ473T	RES , CARBON	47K OHM 1/5W J
....5	CRD20TJ473T	RES , CARBON	47K OHM 1/5W J
....5	CRD20TJ513T	RES , CARBON	
....5	CRD20TJ513T	RES , CARBON	
....5	CRD20TJ332T	RES , CARBON	3.3K OHM 1/5W J
....5	CRD20TJ332T	RES , CARBON	3.3K OHM 1/5W J
....5	CRD20TJ103T	RES , CARBON	10K OHM 1/5W J
....5	CRD20TJ103T	RES , CARBON	10K OHM 1/5W J
....5	CRD20TJ274T	RES , CARBON	
....5	CRD20TJ274T	RES , CARBON	
....5	CRD20TJ332T	RES , CARBON	3.3K OHM 1/5W J
....5	CRD20TJ332T	RES , CARBON	3.3K OHM 1/5W J
....5	CRD20TJ103T	RES , CARBON	10K OHM 1/5W J
....5	CRD20TJ103T	RES , CARBON	10K OHM 1/5W J
....5	CRD20TJ103T	RES , CARBON	10K OHM 1/5W J
....5	CRD20TJ103T	RES , CARBON	10K OHM 1/5W J
....5	CRD20TJ103T	RES , CARBON	10K OHM 1/5W J
....5	CRD20TJ222T	RES , CARBON	2.2K OHM 1/5W J
....5	CRD20TJ222T	RES , CARBON	2.2K OHM 1/5W J
....5	CRD20TJ151T	RES , CARBON	150 OHM 1/5W J
....5	CRD20TJ151T	RES , CARBON	150 OHM 1/5W J
....5	CRD20TJ151T	RES , CARBON	150 OHM 1/5W J
....5	CRD20TJ683T	RES , CARBON	68K OHM 1/5W J
....5	CRD20TJ683T	RES , CARBON	68K OHM 1/5W J

....5	CRD20TJ102T	RES , CARBON	1K OHM 1/5W J
....5	CRD20TJ102T	RES , CARBON	1K OHM 1/5W J
....5	CRD20TJ151T	RES , CARBON	150 OHM 1/5W J
....5	CRD20TJ274T	RES , CARBON	
....5	CRD20TJ273T	RES , CARBON	27K OHM 1/5W J
....5	CRD20TJ274T	RES , CARBON	
....5	CRD20TJ273T	RES , CARBON	27K OHM 1/5W J
....5	CRD20TJ330T	RES , CARBON	33 OHM 1/5W J
....5	CRD20TJ181T	RES , CARBON	180 OHM 1/5W J
....5	CRD20TJ151T	RES , CARBON	150 OHM 1/5W J
....5	CRD20TJ331T	RES , CARBON	330 OHM 1/5W J
....5	CRD20TJ473T	RES , CARBON	47K OHM 1/5W J
....5	CRD20TJ222T	RES , CARBON	2.2K OHM 1/5W J
....5	CRD20TJ103T	RES , CARBON	10K OHM 1/5W J
....5	CRD20TJ223T	RES , CARBON	22K OHM 1/5W J
....5	CRD20TJ223T	RES , CARBON	22K OHM 1/5W J
....5	CRD20TJ223T	RES , CARBON	22K OHM 1/5W J
....5	CRD20TJ223T	RES , CARBON	22K OHM 1/5W J
....5	CRD20TJ103T	RES , CARBON	10K OHM 1/5W J
....5	CRD20TJ102T	RES , CARBON	1K OHM 1/5W J
....5	CRD20TJ223T	RES , CARBON	22K OHM 1/5W J
....5	CRD20TJ223T	RES , CARBON	22K OHM 1/5W J
....5	CRD20TJ223T	RES , CARBON	22K OHM 1/5W J
....5	CRD20TJ151T	RES , CARBON	150 OHM 1/5W J
....5	CRD20TJ472T	RES , CARBON	4.7K OHM 1/5W J
....5	CRD20TJ472T	RES , CARBON	4.7K OHM 1/5W J
....5	CRD20TJ472T	RES , CARBON	4.7K OHM 1/5W J
....5	CRD20TJ472T	RES , CARBON	4.7K OHM 1/5W J
....5	CRD25TJ1R0T	RES , CARBON	
....5	CRD20TJ473T	RES , CARBON	47K OHM 1/5W J
....5	CRD20TJ473T	RES , CARBON	47K OHM 1/5W J
....5	CRD20TJ223T	RES , CARBON	22K OHM 1/5W J
....5	CRD20TJ223T	RES , CARBON	22K OHM 1/5W J
....5	CRD20TJ105T	RES , CARBON	1M OHM 1/5W J
....5	CRD20TJ105T	RES , CARBON	1M OHM 1/5W J
....5	CRD20TJ822T	RES , CARBON	8.2K OHM 1/5W J
....5	CRD20TJ822T	RES , CARBON	8.2K OHM 1/5W J
....5	CRD20TJ103T	RES , CARBON	10K OHM 1/5W J
....5	CRD20TJ151T	RES , CARBON	150 OHM 1/5W J
....5	CRD20TJ102T	RES , CARBON	1K OHM 1/5W J
....5	CRD20TJ473T	RES , CARBON	47K OHM 1/5W J
....5	CRD20TJ223T	RES , CARBON	22K OHM 1/5W J
....5	CRD20TJ102T	RES , CARBON	1K OHM 1/5W J
....5	CRD20TJ473T	RES , CARBON	47K OHM 1/5W J
....5	CRD20TJ103T	RES , CARBON	10K OHM 1/5W J
....5	CRD20TJ102T	RES , CARBON	1K OHM 1/5W J
....5	CRD20TJ473T	RES , CARBON	47K OHM 1/5W J
....5	CRD20TJ473T	RES , CARBON	47K OHM 1/5W J

....5	CRD20TJ272T	RES , CARBON	2.7K OHM 1/5W J
....5	CRD20TJ223T	RES , CARBON	22K OHM 1/5W J
....5	CRD20TJ151T	RES , CARBON	150 OHM 1/5W J
....5	CRD20TJ151T	RES , CARBON	150 OHM 1/5W J
....5	CRD20TJ224T	RES , CARBON	220 KOHM 1/5W J
....5	CRD20TJ473T	RES , CARBON	47K OHM 1/5W J
....5	CRD20TJ473T	RES , CARBON	47K OHM 1/5W J
....5	CRD20TJ151T	RES , CARBON	150 OHM 1/5W J
....5	CRD20TJ151T	RES , CARBON	150 OHM 1/5W J
....5	CRD20TJ151T	RES , CARBON	150 OHM 1/5W J
....5	CRD20TJ151T	RES , CARBON	150 OHM 1/5W J
....5	CRD20TJ473T	RES , CARBON	47K OHM 1/5W J
....5	CRD20TJ473T	RES , CARBON	47K OHM 1/5W J
....5	CRD20TJ682T	RES , CARBON	6.8K OHM 1/5W J
....5	CRD20TJ682T	RES , CARBON	6.8K OHM 1/5W J
....5	CRD20TJ473T	RES , CARBON	47K OHM 1/5W J
....5	CRD20TJ473T	RES , CARBON	47K OHM 1/5W J
....5	CRD20TJ223T	RES , CARBON	22K OHM 1/5W J
....5	CRD20TJ223T	RES , CARBON	22K OHM 1/5W J
....5	CRD20TJ223T	RES , CARBON	22K OHM 1/5W J
....5	CRD20TJ223T	RES , CARBON	22K OHM 1/5W J
....5	CRD20TJ103T	RES , CARBON	10K OHM 1/5W J
....5	CRD20TJ103T	RES , CARBON	10K OHM 1/5W J
....5	CRD20TJ473T	RES , CARBON	47K OHM 1/5W J
....5	CRD20TJ332T	RES , CARBON	3.3K OHM 1/5W J
....5	CRD25FJ100T	RES , CARBON	10 OHM 1/4W J
....5	CRD20TJ103T	RES , CARBON	10K OHM 1/5W J
....5	CRD20TJ473T	RES , CARBON	47K OHM 1/5W J
....5	CRD20TJ333T	RES , CARBON	33K OHM 1/5W J
....5	CRD20TJ473T	RES , CARBON	47K OHM 1/5W J
....5	CRD20TJ222T	RES , CARBON	2.2K OHM 1/5W J
....5	CRD20TJ333T	RES , CARBON	33K OHM 1/5W J
....5	CST1A012ZT	SW , TACT	SKHV10910G
....5	CST1A012ZT	SW , TACT	SKHV10910G
....5	CST1A012ZT	SW , TACT	SKHV10910G
....5	CST1A012ZT	SW , TACT	SKHV10910G
...4	CQB1D022	A-ROHS/LABEL,SERIAL	
...4	C2K86002	SOLDER , BAR SN PB FREE	HSE-16(P) B20
...4	C2K86102	SOLDER , FLUX WIRE PB FREE(PI	HSE-04 W1.0
...4	C8E534	FLUX	
...4	CMD1A387	BRACKET , PCB	
...4	CMD1A387	BRACKET , PCB	
...4	CMD1A387	BRACKET , PCB	
...4	CWZAM1100BN	WIRE ASS'Y	
...4	CWZAR600BN0	WIRE ASS'Y	
...4	CWZAR600EUR	WIRE ASS'Y	
...4	CWZAM1100BN	WIRE ASS'Y	
...4	CWZAM1100BN	WIRE ASS'Y	

...4	CWZAM1100BN	WIRE ASS'Y		
...4	CWB1B904200B	WIRE ASS'Y		
...4	CWZAR600BN1	WIRE ASS'Y		
...4	CWB1D006240B	WIRE ASS'Y		
...4	CWZAM1100BN	WIRE ASS'Y		
...4	CWZAR600EUR	WIRE ASS'Y		
...4	CWZAR600BN4	WIRE ASS'Y		
...4	CWB1B904150B	WIRE ASS'Y		
...4	CWZAR600BN9	WIRE ASS'Y		
...4	CJP04GA01ZY	WAFER , STRAIGHT(4PIN)		
...4	CJP03GA01ZY	WAFER		
...4	CJP04GA01ZY	WAFER , STRAIGHT(4PIN)		
...4	CJP03GA01ZY	WAFER		
...4	CJP03GB03ZY	WAFER		
...4	CJP02KA060ZY	WAFER		
...4	CJP03KA060ZY	WAFER		
...4	CJP02GA89ZY	WAFER		
...4	CJP06GA01ZY	WAFER , 6PIN		
...4	CJP03GA01ZY	WAFER		
...4	CJP04GB03ZY	WAFER		
...4	CJP06GB46ZY	WAFER , ANGLE(6PIN)		
...4	CCEA1EH102E	CAP , ELECT		1000UF 25V
...4	HCKWKH472ME	CAP , CERAMIC(KH TYPE)	JP	DE1310-610E472M
...4	HCKWKH472ME	CAP , CERAMIC(KH TYPE)	JP	DE1310-610E472M
...4	HVIMC4558S	I.C		
...4	HVIMC4558S	I.C		
...4	HVICD4066BM9	I.C , SWITCH		
...4	HVITMP87PH47U	I.C, O.T.P		TMP87PH47U
...4	HVIMC4558S	I.C		
...4	HVIMC4558S	I.C		
...4	HVIMC4558S	I.C		
...4	HVIKIA7805API	REGULATOR, +5V		7805API (KEC)
...4	CJJ4N010Z	JACK , BOARD		
...4	CJJ2E020Z	JACK		
...4	CJJ2E020Z	JACK		
...4	CWZAM1100JW	WIRE ASS'Y		
...4	CWZPRO450JW	WIRE ASS'Y		
...4	CWZAAV1100W	WIRE ASS'Y		
...4	CWEP202110VV	WIRE		
...4	CWEP215110VV	WIRE		
...4	CWZAR600EUR	WIRE ASS'Y		
...4	KJJ7A022Z	OUTLET , AC(EUR/1P)		A302D0061P
...4	CRVKSM603TH2	SENSOR , REMOCON		KSM603TH2E
...4	CSL4A013ZE	RELAY		
...4	HSL1A008ZE	RELAY		SDT-S-112DMR
...4	CSR2A034Z	VR , ENCODER		
...4	KSH2B003Z	SW , PUSH(VERTICAL)	CN	220014
...4	KSH2B003Z	SW , PUSH(VERTICAL)	CN	220014

...4	HSH2B017Z	SW , PUSH	SPUL19X1M071
...4	CSH1A001ZV	SWITCH	
...4	CLT5J030YE	TRANS , SUB	
...4	CVV2X04B503Z	RES , VARIABLE TONE	
...4	CVV2X04B503Z	RES , VARIABLE TONE	
...4	CVV1U01W104Y	RES , VARIABLE	
...4	CVV1U01B503Y	RES , VARIABLE	
...4	CVV9Y12B104Z	VOLUME , MOTOR	
...4	HOX08000E1600	CRYSTAL 8MHz	
..3	CTB3+10GR	SCREW	
..3	CTB3+8JR	SCREW	
..3	CTWS3+10GR	SCREW	
..3	CUS1A084	SPRING , FORMING	
..3	C4FA031	TAPE , BOTH SIDE	NITTO #500
..3	C8AG311	GREASE	
..3	KGX1A216VA	VOLUME CAP ASS'Y(A)	
...4	KBN1A059	KNOB , VOLUME(A)	A4-95-2336
...4	KGX1A216C2	CAP , VOLUME(A)	
...4	KGX1A220VC2	PLATE,VOLUME	
..3	KGX1A216YA	VOLUME CAP ASS'Y(A)	
...4	KBN1A104	KNOB(A) , VOLUME	A-R600
...4	KGX1A216C2	CAP , VOLUME(A)	
...4	KGX1A220C2	PLATE , VOLUME	
..3	KGX1A219C58	HOUSING,VOLUME	
..3	KGX2A219C58	HOUSING,VOLUME	
.2	CKC3A085B25	CABINET , TOP	
.2	CTB3+8JFZR	SCREW	
.2	CTB4+12JFZR	SCREW	
.2	CTB4+6FFZR	SCREW	
.2	CUAAR610EUR	BOTTOM CHASSIS ASS'Y	
..3	CHE170	HOLDER , PCB	
..3	CHG1A113	RUBBER	
..3	CHR301	CLAMPER	
..3	CHS1A032	TAPE , HEMELON	
..3	CJA2B044ZA	CORD , POWER	EUR 16A 250V
..3	CKF6A146U	PANEL,REAR	
..3	CKL1A012	FOOT , RUBBER(BLACK)	
..3	CKL2A042H11	FOOT , FRONT	
..3	CLT5V016YE	TRANS	
..3	CLZ9W003Z	FERRITE , RING	29X7.7X19
..3	COP11094E	MAIN PCB ASS'Y	
...4	CHG1A338	RUBBER	
...4	CIP11094E	MAIN PCB AUTO ASS'Y	
....5	CUP11094P	PCB , MAIN	
....5	CCCT1H180JC	CAP , CERAMIC	18PF 50V J
....5	CCCT1H180JC	CAP , CERAMIC	18PF 50V J
....5	CCKT1H151KB	CAP , CERAMIC	150PF 50V K
....5	CCKT1H151KB	CAP , CERAMIC	150PF 50V K

....5	CCEA1EH470T	CAP , ELECT	47UF 25V
....5	CCEA1AH471T	CAP , ELECT	470UF 10V
....5	CCFT1H473ZF	CAP , CERAMIC	0.047UF 50V Z
....5	CCFT1H103ZF	CAP , CERAMIC	0.01UF 50V Z
....5	CCEA1CH101T	CAP , ELECT	100UF 16V
....5	CCEA1EH470T	CAP , ELECT	47UF 25V
....5	CCEA1HH4R7T	CAP , ELECT	4.7UF 50V
....5	CCEA1HH4R7T	CAP , ELECT	4.7UF 50V
....5	CCCT1H030CC	CAP , CERAMIC	3PF 50V C
....5	CCCT1H030CC	CAP , CERAMIC	3PF 50V C
....5	CCKT1H561KB	CAP , CERAMIC	560PF 50V K
....5	CCKT1H561KB	CAP , CERAMIC	560PF 50V K
....5	HCQI1H332JZT	CAP , MYLAR	3300PF 50V J
....5	HCQI1H332JZT	CAP , MYLAR	3300PF 50V J
....5	CCEA1HH221T	CAP , ELECT	220UF 50V
....5	CCEA1HH221T	CAP , ELECT	220UF 50V
....5	CCEA1HH221T	CAP , ELECT	220UF 50V
....5	CCEA1HH221T	CAP , ELECT	220UF 50V
....5	CCCT1H120JC	CAP , CERAMIC	12PF 50V J
....5	CCCT1H120JC	CAP , CERAMIC	12PF 50V J
....5	HCQI1H473JZT	CAP , MYLAR	0.047UF 50V J
....5	HCQI1H473JZT	CAP , MYLAR	0.047UF 50V J
....5	HCQI1H102JZT	CAP , MYLAR	1000PF 50V J
....5	HCQI1H102JZT	CAP , MYLAR	1000PF 50V J
....5	CCEA1HH4R7T	CAP , ELECT	4.7UF 50V
....5	CCEA1HH4R7T	CAP , ELECT	4.7UF 50V
....5	CCEA1HH4R7T	CAP , ELECT	4.7UF 50V
....5	CCEA1HH4R7T	CAP , ELECT	4.7UF 50V
....5	CCBS1H391KBT	CAP , CERAMIC(390PF/50V)	CH UP025 B391K-A-B Z
....5	CCBS1H391KBT	CAP , CERAMIC(390PF/50V)	CH UP025 B391K-A-B Z
....5	CCCT1H120JC	CAP , CERAMIC	12PF 50V J
....5	CCCT1H120JC	CAP , CERAMIC	12PF 50V J
....5	CCCT1H030CC	CAP , CERAMIC	3PF 50V C
....5	CCCT1H030CC	CAP , CERAMIC	3PF 50V C
....5	CCEA1EH470T	CAP , ELECT	47UF 25V
....5	CCEA1EH470T	CAP , ELECT	47UF 25V
....5	HCQI1H473JZT	CAP , MYLAR	0.047UF 50V J
....5	HCQI1H473JZT	CAP , MYLAR	0.047UF 50V J
....5	CCKT1H221KB	CAP , CERAMIC	220PF 50V K
....5	CCKT1H221KB	CAP , CERAMIC	220PF 50V K
....5	CCEA1HH1R0T	CAP , ELECT	1UF 50V
....5	CCEA1HH1R0T	CAP , ELECT	1UF 50V
....5	CCEA1HH470T	CAP , ELECT	47UF 50V
....5	CCEA1HH470T	CAP , ELECT	47UF 50V
....5	CCEA1EH470T	CAP , ELECT	47UF 25V
....5	CCEA1EH470T	CAP , ELECT	47UF 25V
....5	CCEA1HH470T	CAP , ELECT	47UF 50V
....5	CCEA1HH470T	CAP , ELECT	47UF 50V

....5	CCCT1H560JC	CAP , CERAMIC	56PF 50V J
....5	CCCT1H560JC	CAP , CERAMIC	56PF 50V J
....5	CCCT1H100DC	CAP , CERAMIC	10PF 50V D
....5	CCCT1H100DC	CAP , CERAMIC	10PF 50V D
....5	CCEA1HH470T	CAP , ELECT	47UF 50V
....5	CCEA1HH470T	CAP , ELECT	47UF 50V
....5	CCCT1H220JC	CAP , CERAMIC	22PF 50V J
....5	CCCT1H220JC	CAP , CERAMIC	22PF 50V J
....5	CCCT1H220JC	CAP , CERAMIC	22PF 50V J
....5	CCCT1H220JC	CAP , CERAMIC	22PF 50V J
....5	HCEA2AU100T	CAP , ELECT	
....5	HCEA2AU100T	CAP , ELECT	
....5	HCEA2AU100T	CAP , ELECT	
....5	HCEA2AU100T	CAP , ELECT	
....5	CCKT1H101KB	CAP , CERAMIC	100PF 50V K
....5	CCKT1H101KB	CAP , CERAMIC	100PF 50V K
....5	CCKT1H101KB	CAP , CERAMIC	100PF 50V K
....5	CCKT1H101KB	CAP , CERAMIC	100PF 50V K
....5	CCKT1H561KB	CAP , CERAMIC	560PF 50V K
....5	CCKT1H561KB	CAP , CERAMIC	560PF 50V K
....5	CCBS1H103ZFT	CAP , CERAMIC	0.01UF 50V Z
....5	CCBS1H103ZFT	CAP , CERAMIC	0.01UF 50V Z
....5	HCQI1H222JZT	CAP , MYLAR	2200PF 50V J
....5	HCQI1H222JZT	CAP , MYLAR	2200PF 50V J
....5	HCQI1H222JZT	CAP , MYLAR	2200PF 50V J
....5	HCQI1H222JZT	CAP , MYLAR	2200PF 50V J
....5	HCQI1H223JZT	CAP , MYLAR	0.022UF 50V J
....5	HCQI1H223JZT	CAP , MYLAR	0.022UF 50V J
....5	CCEA1CH101T	CAP , ELECT	100UF 16V
....5	CCFT1H103ZF	CAP , CERAMIC	0.01UF 50V Z
....5	CCEA1VH101T	CAP , ELECT	100UF 35V
....5	CCFT1H103ZF	CAP , CERAMIC	0.01UF 50V Z
....5	CCEA1VH101T	CAP , ELECT	100UF 35V
....5	CCFT1H103ZF	CAP , CERAMIC	0.01UF 50V Z
....5	CCEA1HH101T	CAP , ELECT	100UF 50V
....5	CCEA1HH101T	CAP , ELECT	100UF 50V
....5	CCFT1H223ZF	CAP , CERAMIC	0.022UF 50V Z
....5	CCFT1H223ZF	CAP , CERAMIC	0.022UF 50V Z
....5	CCEA1HH101T	CAP , ELECT	100UF 50V
....5	CCEA1HH101T	CAP , ELECT	100UF 50V
....5	HCQI1H103JZT	CAP , MYLAR	0.01UF 50V J
....5	HCQI1H103JZT	CAP , MYLAR	0.01UF 50V J
....5	HCQI1H103JZT	CAP , MYLAR	0.01UF 50V J
....5	HCQI1H103JZT	CAP , MYLAR	0.01UF 50V J
....5	HCQI1H473JZT	CAP , MYLAR	0.047UF 50V J
....5	HCQI1H473JZT	CAP , MYLAR	0.047UF 50V J
....5	HCQI1H102JZT	CAP , MYLAR	1000PF 50V J
....5	HCQI1H102JZT	CAP , MYLAR	1000PF 50V J

....5	CVD1SS133MT	DIODE	1SS133
....5	CVD1SS133MT	DIODE	1SS133
....5	CVD1SS133MT	DIODE	1SS133
....5	CVD1SS133MT	DIODE	1SS133
....5	CVD1SS133MT	DIODE	1SS133
....5	CVD1SS133MT	DIODE	1SS133
....5	CVD1SS133MT	DIODE	1SS133
....5	CVD1SS133MT	DIODE	1SS133
....5	CVD1SS133MT	DIODE	1SS133
....5	CVD1SS133MT	DIODE	1SS133
....5	CVD1N4003ST	DIODE , RECT	1N4003
....5	CVD1N4003ST	DIODE , RECT	1N4003
....5	CVD1N4003ST	DIODE , RECT	1N4003
....5	CVD1N4003ST	DIODE , RECT	1N4003
....5	CVD1N4003ST	DIODE , RECT	1N4003
....5	CVD1N4003ST	DIODE , RECT	1N4003
....5	CVD1N4003ST	DIODE , RECT	1N4003
....5	CVD1N4003ST	DIODE , RECT	1N4003
....5	CVD1N4003ST	DIODE , RECT	1N4003
....5	CVDZJ30BT	DIODE , ZENER	ZJ30B 1/2W
....5	CVDZJ30BT	DIODE , ZENER	ZJ30B 1/2W
....5	CVD1SS133MT	DIODE	1SS133
....5	HVTKTC2874BT	T.R , MUTE	KTC2874B
....5	HVTKTC2874BT	T.R , MUTE	KTC2874B
....5	HVTKTC2874BT	T.R , MUTE	KTC2874B
....5	HVTKTC2874BT	T.R , MUTE	KTC2874B
....5	HVTKTC3198YT	T.R	KTC3198Y
....5	HVTKTC3198YT	T.R	KTC3198Y
....5	HVTKTC3198YT	T.R	KTC3198Y
....5	HVTKTC3198YT	T.R	KTC3198Y
....5	HVTKRA107MT	T.R	KRA107M
....5	HVTKRA107MT	T.R	KRA107M
....5	HVTKRA107MT	T.R	KRA107M
....5	HVTKTC3203YT	T.R	KTC3203Y
....5	HVTKTC3203YT	T.R	KTC3203Y
....5	HVTKTC3198YT	T.R	KTC3198Y
....5	HVTKRA107MT	T.R	KRA107M
....5	HVTKTC3198YT	T.R	KTC3198Y
....5	CVTKTA1272YT	T.R , KTA1272Y-AP/P(TO-92M)	
....5	HVTKTA1268GR	T.R	KTA1268GR
....5	HVTKTA1268GR	T.R	KTA1268GR
....5	HVTKTA1268GR	T.R	KTA1268GR
....5	HVTKTA1268GR	T.R	KTA1268GR
....5	HVTKTC3200GR	T.R	KTC3200GR
....5	HVTKTC3200GR	T.R	KTC3200GR
....5	HVTKTA1266YT	T.R	TKTA1266YT
....5	HVTKTA1266YT	T.R	TKTA1266YT
....5	HVTKTC3198YT	T.R	KTC3198Y

....5	HVTKTC3198YT	T.R	KTC3198Y
....5	HVTKTC2874BT	T.R , MUTE	KTC2874B
....5	HVTKTC2874BT	T.R , MUTE	KTC2874B
....5	HVTKTC2874BT	T.R , MUTE	KTC2874B
....5	HVTKTC2874BT	T.R , MUTE	KTC2874B
....5	HVT2SK117-BL	F.E.T	
....5	HVT2SK117-BL	F.E.T	
....5	HVT2SK117-BL	F.E.T	
....5	HVT2SK117-BL	F.E.T	
....5	CVTKTC1027YT	T.R	
....5	HVTKSA916YT	T.R	
....5	CRD20TJ471T	RES , CARBON	470 OHM 1/5W J
....5	CRD20TJ471T	RES , CARBON	470 OHM 1/5W J
....5	CRD20TJ561T	RES , CARBON	560 OHM 1/5W J
....5	CRD20TJ561T	RES , CARBON	560 OHM 1/5W J
....5	CRD20TJ563T	RES , CARBON	56K OHM 1/5W J
....5	CRD20TJ563T	RES , CARBON	56K OHM 1/5W J
....5	CRD20TJ123T	RES , CARBON	12K OHM 1/5W J
....5	CRD20TJ123T	RES , CARBON	12K OHM 1/5W J
....5	CRD20TJ184T	RES , CARBON	
....5	CRD20TJ184T	RES , CARBON	
....5	CRD20TJ561T	RES , CARBON	560 OHM 1/5W J
....5	CRD20TJ561T	RES , CARBON	560 OHM 1/5W J
....5	CRD20TJ221T	RES , CARBON	220 OHM 1/5W J
....5	CRD20TJ221T	RES , CARBON	220 OHM 1/5W J
....5	CRD20TJ224T	RES , CARBON	220 KOHM 1/5W J
....5	CRD20TJ224T	RES , CARBON	220 KOHM 1/5W J
....5	CRD25TJ151T	RES , CARBON	150 OHM 1/4W J
....5	CRD25TJ151T	RES , CARBON	150 OHM 1/4W J
....5	CRD20TJ102T	RES , CARBON	1K OHM 1/5W J
....5	CRD20TJ102T	RES , CARBON	1K OHM 1/5W J
....5	CRD20TJ102T	RES , CARBON	1K OHM 1/5W J
....5	CRD20TJ102T	RES , CARBON	1K OHM 1/5W J
....5	CRD20TJ102T	RES , CARBON	1K OHM 1/5W J
....5	CRD20TJ102T	RES , CARBON	1K OHM 1/5W J
....5	CRD20TJ102T	RES , CARBON	1K OHM 1/5W J
....5	CRD20TJ471T	RES , CARBON	470 OHM 1/5W J
....5	CRD20TJ471T	RES , CARBON	470 OHM 1/5W J
....5	CRD20TJ102T	RES , CARBON	1K OHM 1/5W J
....5	CRD20TJ102T	RES , CARBON	1K OHM 1/5W J
....5	CRD20TJ471T	RES , CARBON	470 OHM 1/5W J
....5	CRD20TJ471T	RES , CARBON	470 OHM 1/5W J
....5	CRD20TJ102T	RES , CARBON	1K OHM 1/5W J
....5	CRD20TJ102T	RES , CARBON	1K OHM 1/5W J
....5	CRD20TJ473T	RES , CARBON	47K OHM 1/5W J
....5	CRD20TJ473T	RES , CARBON	47K OHM 1/5W J
....5	CRD20TJ473T	RES , CARBON	47K OHM 1/5W J

....5	CRD20TJ473T	RES , CARBON	47K OHM 1/5W J
....5	CRD20TJ473T	RES , CARBON	47K OHM 1/5W J
....5	CRD20TJ473T	RES , CARBON	47K OHM 1/5W J
....5	CRD20TJ473T	RES , CARBON	47K OHM 1/5W J
....5	CRD20TJ473T	RES , CARBON	47K OHM 1/5W J
....5	CRD20TJ473T	RES , CARBON	47K OHM 1/5W J
....5	CRD20TJ473T	RES , CARBON	47K OHM 1/5W J
....5	CRD20TJ473T	RES , CARBON	47K OHM 1/5W J
....5	CRD20TJ473T	RES , CARBON	47K OHM 1/5W J
....5	CRD20TJ473T	RES , CARBON	47K OHM 1/5W J
....5	CRD20TJ472T	RES , CARBON	4.7K OHM 1/5W J
....5	CRD20TJ472T	RES , CARBON	4.7K OHM 1/5W J
....5	CRD20TJ472T	RES , CARBON	4.7K OHM 1/5W J
....5	CRD20TJ472T	RES , CARBON	4.7K OHM 1/5W J
....5	CRD20TJ151T	RES , CARBON	150 OHM 1/5W J
....5	CRD20TJ151T	RES , CARBON	150 OHM 1/5W J
....5	CRD20TJ472T	RES , CARBON	4.7K OHM 1/5W J
....5	CRD20TJ472T	RES , CARBON	4.7K OHM 1/5W J
....5	CRD20TJ472T	RES , CARBON	4.7K OHM 1/5W J
....5	CRD20TJ103T	RES , CARBON	10K OHM 1/5W J
....5	CRD25TJ103T	RES , CARBON	
....5	CRD20TJ222T	RES , CARBON	2.2K OHM 1/5W J
....5	CRD20TJ222T	RES , CARBON	2.2K OHM 1/5W J
....5	CRD20TJ153T	RES , CARBON	15K OHM 1/5W J
....5	CRD20TJ153T	RES , CARBON	15K OHM 1/5W J
....5	CRD20TJ123T	RES , CARBON	12K OHM 1/5W J
....5	CRD20TJ123T	RES , CARBON	12K OHM 1/5W J
....5	CRD20TJ333T	RES , CARBON	33K OHM 1/5W J
....5	CRD20TJ333T	RES , CARBON	33K OHM 1/5W J
....5	CRD25TJ333T	RES , CARBON	
....5	CRD20TJ183T	RES , CARBON	18K OHM 1/5W J
....5	CRD20TJ183T	RES , CARBON	18K OHM 1/5W J
....5	CRD20TJ101T	RES , CARBON	100 OHM 1/5W J
....5	CRD25TJ103T	RES , CARBON	
....5	CRD20TJ103T	RES , CARBON	10K OHM 1/5W J
....5	CRD20TJ103T	RES , CARBON	10K OHM 1/5W J
....5	CRD20TJ333T	RES , CARBON	33K OHM 1/5W J
....5	CRD20TJ103T	RES , CARBON	10K OHM 1/5W J
....5	CRD20TJ333T	RES , CARBON	33K OHM 1/5W J
....5	CRD20TJ820T	RES , CARBON	82 OHM 1/5W J
....5	CRD20TJ820T	RES , CARBON	82 OHM 1/5W J
....5	CRD20TJ820T	RES , CARBON	82 OHM 1/5W J
....5	CRD20TJ820T	RES , CARBON	82 OHM 1/5W J
....5	CRD20TJ223T	RES , CARBON	22K OHM 1/5W J
....5	CRD20TJ471T	RES , CARBON	470 OHM 1/5W J
....5	CRD20TJ682T	RES , CARBON	6.8K OHM 1/5W J
....5	CRD20TJ222T	RES , CARBON	2.2K OHM 1/5W J

....5	CRD20TJ100T	RES , CARBON	10 OHM 1/5W J
....5	CRD20TJ103T	RES , CARBON	10K OHM 1/5W J
....5	CRD20TJ222T	RES , CARBON	2.2K OHM 1/5W J
....5	CRD20TJ473T	RES , CARBON	47K OHM 1/5W J
....5	CRD20TJ682T	RES , CARBON	6.8K OHM 1/5W J
....5	CRD20TJ682T	RES , CARBON	6.8K OHM 1/5W J
....5	CRD20TJ121T	RES , CARBON	120 OHM 1/5W J
....5	CRD20TJ121T	RES , CARBON	120 OHM 1/5W J
....5	CRD20TJ223T	RES , CARBON	22K OHM 1/5W J
....5	CRD20TJ223T	RES , CARBON	22K OHM 1/5W J
....5	CRD20TJ101T	RES , CARBON	100 OHM 1/5W J
....5	CRD20TJ101T	RES , CARBON	100 OHM 1/5W J
....5	CRD20TJ223T	RES , CARBON	22K OHM 1/5W J
....5	CRD20TJ223T	RES , CARBON	22K OHM 1/5W J
....5	CRD20TJ222T	RES , CARBON	2.2K OHM 1/5W J
....5	CRD20TJ222T	RES , CARBON	2.2K OHM 1/5W J
....5	CRD20TJ273T	RES , CARBON	27K OHM 1/5W J
....5	CRD20TJ273T	RES , CARBON	27K OHM 1/5W J
....5	CRD20TJ222T	RES , CARBON	2.2K OHM 1/5W J
....5	CRD20TJ222T	RES , CARBON	2.2K OHM 1/5W J
....5	CRD20TJ222T	RES , CARBON	2.2K OHM 1/5W J
....5	CRD20TJ222T	RES , CARBON	2.2K OHM 1/5W J
....5	CRD20TJ333T	RES , CARBON	33K OHM 1/5W J
....5	CRD20TJ333T	RES , CARBON	33K OHM 1/5W J
....5	CRD20TJ102T	RES , CARBON	1K OHM 1/5W J
....5	CRD20TJ102T	RES , CARBON	1K OHM 1/5W J
....5	CRD20TJ102T	RES , CARBON	1K OHM 1/5W J
....5	CRD20TJ102T	RES , CARBON	1K OHM 1/5W J
....5	CRD20TJ911T	RES , CARBON	910 OHM 1/5W J
....5	CRD20TJ911T	RES , CARBON	910 OHM 1/5W J
....5	CRD25TJ560T	RES , CARBON	
....5	CRD25TJ560T	RES , CARBON	
....5	CRD25TJ560T	RES , CARBON	
....5	CRD25TJ560T	RES , CARBON	
....5	CRD20TJ122T	RES , CARBON	1.2K OHM 1/5W J
....5	CRD20TJ122T	RES , CARBON	1.2K OHM 1/5W J
....5	CRD20TJ102T	RES , CARBON	1K OHM 1/5W J
....5	CRD20TJ102T	RES , CARBON	1K OHM 1/5W J
....5	CRD20TJ563T	RES , CARBON	56K OHM 1/5W J
....5	CRD20TJ563T	RES , CARBON	56K OHM 1/5W J
....5	CRD20TJ102T	RES , CARBON	1K OHM 1/5W J
....5	CRD20TJ102T	RES , CARBON	1K OHM 1/5W J
....5	CRD20TJ472T	RES , CARBON	4.7K OHM 1/5W J
....5	CRD20TJ472T	RES , CARBON	4.7K OHM 1/5W J
....5	CRD20TJ271T	RES , CARBON	270 OHM 1/5W J
....5	CRD20TJ271T	RES , CARBON	270 OHM 1/5W J
....5	CRD20TJ472T	RES , CARBON	4.7K OHM 1/5W J
....5	CRD20TJ472T	RES , CARBON	4.7K OHM 1/5W J

....5	CRD20TJ473T	RES , CARBON	47K OHM 1/5W J
....5	CRD20TJ473T	RES , CARBON	47K OHM 1/5W J
....5	CRD20TJ473T	RES , CARBON	47K OHM 1/5W J
....5	CRD20TJ473T	RES , CARBON	47K OHM 1/5W J
....5	CRD20TJ392T	RES , CARBON	3.9K OHM 1/5W J
....5	CRD20TJ392T	RES , CARBON	3.9K OHM 1/5W J
....5	CRD20TJ101T	RES , CARBON	100 OHM 1/5W J
....5	CRD20TJ101T	RES , CARBON	100 OHM 1/5W J
....5	CRD25TJ101T	RES , CARBON	
....5	CRD20TJ101T	RES , CARBON	100 OHM 1/5W J
....5	CRD25TJ101T	RES , CARBON	
....5	CRD25TJ101T	RES , CARBON	
....5	CRD20TJ221T	RES , CARBON	220 OHM 1/5W J
....5	CRD20TJ221T	RES , CARBON	220 OHM 1/5W J
....5	CRD20TJ105T	RES , CARBON	1M OHM 1/5W J
....5	CRD20TJ105T	RES , CARBON	1M OHM 1/5W J
....5	CRD20TJ222T	RES , CARBON	2.2K OHM 1/5W J
....5	CRD20TJ222T	RES , CARBON	2.2K OHM 1/5W J
....5	CRD20TJ153T	RES , CARBON	15K OHM 1/5W J
....5	CRD20TJ153T	RES , CARBON	15K OHM 1/5W J
....5	CRD20TJ472T	RES , CARBON	4.7K OHM 1/5W J
....5	CRD20TJ472T	RES , CARBON	4.7K OHM 1/5W J
....5	CRD20TJ272T	RES , CARBON	2.7K OHM 1/5W J
....5	CRD20TJ272T	RES , CARBON	2.7K OHM 1/5W J
....5	CRD20TJ471T	RES , CARBON	470 OHM 1/5W J
....5	CRD20TJ471T	RES , CARBON	470 OHM 1/5W J
....5	CRD20TJ821T	RES , CARBON	820 OHM 1/5W J
....5	CRD20TJ821T	RES , CARBON	820 OHM 1/5W J
....5	CRD20TJ361T	RES , CARBON	360 OHM 1/5W J
....5	CRD20TJ361T	RES , CARBON	360 OHM 1/5W J
....5	CRD25FJ101T	RES , CARBON	100 OHM 1/4W J
....5	CRD25FJ101T	RES , CARBON	100 OHM 1/4W J
....5	CRD25FJ101T	RES , CARBON	100 OHM 1/4W J
....5	CRD25FJ101T	RES , CARBON	100 OHM 1/4W J
....5	CRD25FJ101T	RES , CARBON	100 OHM 1/4W J
....5	CRD25FJ100T	RES , CARBON	10 OHM 1/4W J
....5	CRD25FJ100T	RES , CARBON	10 OHM 1/4W J
....5	CRD25FJ100T	RES , CARBON	10 OHM 1/4W J
....5	CRD25FJ100T	RES , CARBON	10 OHM 1/4W J
....5	CRD25FJ100T	RES , CARBON	10 OHM 1/4W J
....5	CRD20TJ102T	RES , CARBON	1K OHM 1/5W J
....5	CRD20TJ102T	RES , CARBON	1K OHM 1/5W J
....5	CRD20TJ224T	RES , CARBON	220 KOHM 1/5W J
....5	CRD20TJ224T	RES , CARBON	220 KOHM 1/5W J
....5	CRD20TJ122T	RES , CARBON	1.2K OHM 1/5W J
....5	CRD20TJ122T	RES , CARBON	1.2K OHM 1/5W J
....5	CRD20TJ102T	RES , CARBON	1K OHM 1/5W J
....5	CRD20TJ183T	RES , CARBON	18K OHM 1/5W J

....5	CRD20TJ103T	RES , CARBON	10K OHM 1/5W J
...4	CMY1A122ZA	HEATSINK ASS'Y	
....5	CDD1A013YA	FAN ASS'Y	
....6	CDD1A013	FAN	
....6	CDMCCM05045F	MOTOR	
....6	CGP3A016	FRAME , FAN	
....6	CSN2+4R	SCREW	ROHS
....6	CWZAV7742	WIRE ASS'Y	
....6	C2K86102	SOLDER , FLUX WIRE PB FREE(PI	HSE-04 W1.0
....5	CGP2A015	COVER , HEAT SINK	
....5	CMY1A122	HEATSINK	
....5	CTB3+8JR	SCREW	
....5	CTW3+12JR	SCREW	
....5	HVTKTD2058Y	T.R	KTD2058Y
....5	HVTKTD2058Y	T.R	KTD2058Y
....5	HVT2SC3519A	T.R , POWER	
....5	HVT2SC3519A	T.R , POWER	
....5	HVT2SA1386A	T.R , POWER	
....5	HVT2SA1386A	T.R , POWER	
....5	KRTNTC5D103	THERMISTER	NTC5D-103KYW10
...4	CNE75	PLATE , EARTH	
...4	CQB1D022	A-ROHS/LABEL,SERIAL	
...4	C2K86002	SOLDER , BAR SN PB FREE	HSE-16(P) B20
...4	C2K86102	SOLDER , FLUX WIRE PB FREE(PI	HSE-04 W1.0
...4	C8AGB288	BOND (MAX)	
...4	C8E534	FLUX	
...4	CWZAM1100BN	WIRE ASS'Y	
...4	CWZAM1100BN	WIRE ASS'Y	
...4	CWZAM1100BN	WIRE ASS'Y	
...4	CWZAR600BN4	WIRE ASS'Y	
...4	CJP05GA01ZY	WAFER(YMW025-05R)	
...4	CJP07GA01ZY	WAFER , STRAIGHT(7PIN)	
...4	CJP04GA01ZY	WAFER , STRAIGHT(4PIN)	
...4	CJP04GA01ZY	WAFER , STRAIGHT(4PIN)	
...4	CJP06GA01ZY	WAFER , 6PIN	
...4	CJP11GA01ZY	WAFER	
...4	CJP06GA01ZY	WAFER , 6PIN	
...4	CJP02GA01ZY	WAFER , STRAIGHT, 2PIN	
...4	CJP04GA01ZY	WAFER , STRAIGHT(4PIN)	
...4	KCKD2H103KB	CAP,CERAMIC 500V	CKB2H103K16BW1
...4	KCKD2H103KB	CAP,CERAMIC 500V	CKB2H103K16BW1
...4	KCKD2H103KB	CAP,CERAMIC 500V	CKB2H103K16BW1
...4	KCKD2H103KB	CAP,CERAMIC 500V	CKB2H103K16BW1
...4	CCET75VPKPO	CAP , ELECT	
...4	CCET75VPKPO	CAP , ELECT	
...4	CCEA1VH102E	CAP , ELECT	
...4	CCEA1VH102E	CAP , ELECT	
...4	CCEA1HH222E	CAP , ELECT	

...4	CCEA1HH222E	CAP , ELECT	
...4	CVDKBPC2504V	BRIDGE DIODE ASS'Y	
...5	CMY1A022	HEATSINK	
...5	CTB3+20JR	SCREW	
...5	HVDKBPC2504V	DIODE , BRIDGE US	KBPC2504WF
...5	K8AYG6260	COMPOUND , SILICONE	
...4	HVINJU7312L	I.C	NJU7312AL
...4	HVIMC4558S	I.C	
...4	CVIMC7815CZA	I.C ASS'Y	
...5	CMY1A025	HEATSINK	
...5	CTB3+8JR	SCREW	
...5	HVIMC7815C	I.C, REGULATOR	KA7815-ABTU
...5	K8AYG6260	COMPOUND , SILICONE	
...4	CVIMC7915CZA	I.C ASS'Y	
...5	CMY1A025	HEATSINK	
...5	CTB3+8JR	SCREW	
...5	HVIMC7915C	I.C, REGULATOR	KA7915-ABTU
...5	K8AYG6260	COMPOUND , SILICONE	
...4	CVIMC7805CZA	I.C ASS'Y	KMY1A025
...5	CMY1A025	HEATSINK	
...5	CTB3+8JR	SCREW	
...5	HVIKIA7805API	REGULATOR, +5V	7805API (KEC)
...5	K8AYG6260	COMPOUND , SILICONE	
...4	CJJ4N040ZAR6	JACK	
...4	CJJ4R019Z	JACK , IN/OUT	
...4	CJJ4R019Z	JACK , IN/OUT	
...4	CWZAM1100JW	WIRE ASS'Y	
...4	CLR9Y003Z	COIL , SPEAKER	
...4	CLR9Y003Z	COIL , SPEAKER	
...4	HVT2SC2911S	T.R	2SC2911S
...4	HVT2SC2911S	T.R	2SC2911S
...4	HVT2SA1209S	T.R	2SA1209S
...4	HVT2SA1209S	T.R	2SA1209S
...4	HVTKTC3200GR	T.R	KTC3200GR
...4	HVTKTC3200GR	T.R	KTC3200GR
...4	HVTKTC3200GR	T.R	KTC3200GR
...4	HVTKTC3200GR	T.R	KTC3200GR
...4	HVTKTA1267YT	T.R	KTA1267Y
...4	HVTKTA1267YT	T.R	KTA1267Y
...4	HVTKTA1267YT	T.R	KTA1267Y
...4	HVTKTA1267YT	T.R	KTA1267Y
...4	HVT2SA1209S	T.R	2SA1209S
...4	HVT2SA1209S	T.R	2SA1209S
...4	HVT2SC2911S	T.R	2SC2911S
...4	HVT2SC2911S	T.R	2SC2911S
...4	HVT2SC2911S	T.R	2SC2911S
...4	HVT2SC2911S	T.R	2SC2911S
...4	HVT2SC3423O	T.R	2SC3423O

...4	HVT2SC3423O	T.R	2SC3423O
...4	HVT2SA1360O	T.R	2SA1360O
...4	HVT2SA1360O	T.R	2SA1360O
...4	HVTKTD2061Y	T.R , DRIVE	KTD2061Y
...4	HVTKTD2061Y	T.R , DRIVE	KTD2061Y
...4	HVTKTB1369Y	T.R , DRIVE	KTB1369Y
...4	HVTKTB1369Y	T.R , DRIVE	KTB1369Y
...4	HSL1A008ZE	RELAY	SDT-S-112DMR
...4	HSL1A008ZE	RELAY	SDT-S-112DMR
...4	HSL1A008ZE	RELAY	SDT-S-112DMR
...4	HSL1A008ZE	RELAY	SDT-S-112DMR
...4	CRG1ANJ681H	RES , METAL OXIDE FILM	680 OHM 1W J
...4	CRG1ANJ681H	RES , METAL OXIDE FILM	680 OHM 1W J
...4	CRG1ANJ471H	RES , METAL OXIDE FILM	470 OHM 1W J
...4	CRG1ANJ471H	RES , METAL OXIDE FILM	470 OHM 1W J
...4	CRG1ANJ273H	RES , METAL OXIDE FILM	27K OHM 1W J
...4	CRG1ANJ273H	RES , METAL OXIDE FILM	27K OHM 1W J
...4	CRG1ANJ100H	RES , METAL OXIDE FILM	10 OHM 1W J
...4	CRG1ANJ100H	RES , METAL OXIDE FILM	10 OHM 1W J
...4	CRG1ANJ100H	RES , METAL OXIDE FILM	10 OHM 1W J
...4	CRG1ANJ100H	RES , METAL OXIDE FILM	10 OHM 1W J
...4	CRF5EKR22H	RES , CEMENT	0.22 OHM 5W K
...4	CRF5EKR22H	RES , CEMENT	0.22 OHM 5W K
...4	CRF5EKR22H	RES , CEMENT	0.22 OHM 5W K
...4	CRF5EKR22H	RES , CEMENT	0.22 OHM 5W K
...4	CRG2ANJ4R7H	RES , METAL OXIDE FILM	
...4	CRG2ANJ4R7H	RES , METAL OXIDE FILM	
...4	CRG2ANJ100H	RES , METAL OXIDE FILM	
...4	CRG2ANJ100H	RES , METAL OXIDE FILM	
...4	CRG2ANJ391H	RES , METAL OXIDE FILM	
...4	CRG2ANJ391H	RES , METAL OXIDE FILM	
...4	CRD50FJ123T	RES , CARBON	
...4	CRD50FJ123T	RES , CARBON	
...4	CRQ1AJR47H	RES , FUSE	
...4	CRQ1AJR47H	RES , FUSE	
...4	CRQ1AJR47H	RES , FUSE	
...4	CRQ1AJR47H	RES , FUSE	
...4	CRD50FJ123T	RES , CARBON	
...4	CRD50FJ123T	RES , CARBON	
...4	CRD50FJ123T	RES , CARBON	
...4	CRD50FJ123T	RES , CARBON	
...4	CRQ1AJ100H	RES , FUSE	
...4	CJJ5P011Z	TERMINAL , SPEAKER	
...4	CJJ5P014Z	TERMINAL , SPEAKER(4P)	PTB-408SA
...4	CJP02GA01ZY	WAFER , STRAIGHT, 2PIN	
...4	CJP02GA01ZY	WAFER , STRAIGHT, 2PIN	
...4	CVN1RA471B02	RES , SEMI FIXED (470, B CURVE)	KVSF637AVC
...4	CVN1RA471B02	RES , SEMI FIXED (470, B CURVE)	KVSF637AVC

..3	CQB1A173Y	LABEL, FUSE CAUTION	
..3	CTB3+10GFZR	SCREW	
..3	CTB3+6JR	SCREW	
..3	CTB3+8JFZR	SCREW	
..3	CTB3+8JR	SCREW	
..3	CTB4+8FR	SCREW	
..3	CTW3+12JR	SCREW	
..3	CTW3+16JR	SCREW	
..3	CTW3+8JR	SCREW	
..3	CUA4A148	CHASSIS , BOTTOM	
..3	C2K86002	SOLDER , BAR SN PB FREE	HSE-16(P) B20
..3	KHG1A050	RUBBER , CUSHION	
..3	KHR1A028	BUSHING , AC CORD	
..3	KMA2A001	TERMINAL , GROUND	
..3	KBA2C4000TLE2	FUSE	
1	CHE154	CLAMPER , ARM	
1	CPB1A013Y	BAG , POLY	
1	CPG1A550Y	BOX , OUT CARTON	
1	CPL18A5M	STAPLE	
1	CPS1A396	PAD , SNOW	
1	CPS1A397	PAD , SNOW	
1	CQB1A590Y	EUR-Y LABEL	TEAC(BOX)
1	CQB1A622	LABEL , SERIAL NO	
1	CQS1A001	RIBON , BAR CODE	SONY(TR-4070)
1	CQT1A144	LABEL , BAR CODE	
1	CQXAR610EUR	INSTRUCTION MANUAL ASS'Y	
.2	CABR03PPB	BATTERY , AAA 2PCS IN PACK	
.2	CARTAR600Y	REMOCON	
.2	CPB1061W	BAG , POLY(ENGLISH/FRANCH)	FRANCE LANGUAGE ADD
.2	CPL0905	STAPLE	
.2	CQE1A370Y	WARRANTY CARD(EUR,UK)	
.2	CQE1A403Z	SHEET , BATTERY TEAC	
.2	CQX1A484W	MANUAL , INSTRUCTION	
1	CRE1A037	LOCKER	SH08M790BO
1	C4FC240CL	TAPE , P.P(24mm*50mm)	
1	C4FC500CL	TAPE , OPP	

Product of ANAM, China, 09/05/07

REF. No.	Q'TY	UNIT	RREMARKS
	1	EA	
	1	EA	
	1	EA	A-R600EUR
	2	EA	A-R600EUR
	1	EA	A-R600EUR
	1	EA	
	3	EA	
	2	EA	A-R600EUR
	1	EA	A-R600EUR
	1	EA	A-R600EUR
	1	EA	
	3	EA	A-R600EUR
	2	EA	A-R600EUR
	1	EA	A-R600EUR
	1	EA	
	2	EA	ALL MODEL
	1	EA	A-R600
	1	EA	A-R600/AG-D9320
	2	EA	A-R600
	3	EA	
	1	EA	
	1	EA	
	1	EA	
C301	1	EA	35V 10UF 5*11
C302	1	EA	35V 10UF 5*11
C303	1	EA	5PF 50V C
C304	1	EA	5PF 50V C
C305	1	EA	HPE473J2AP050T
C306	1	EA	HPE473J2AP050T
C307	1	EA	HPE473J2AP050T
C308	1	EA	HPE473J2AP050T
C309	1	EA	HPE152J2AP050T
C310	1	EA	HPE152J2AP050T
C311	1	EA	HPE152J2AP050T
C312	1	EA	HPE152J2AP050T
C313	1	EA	35V 10UF 5*11
C314	1	EA	35V 10UF 5*11
C315	1	EA	25V 47UF 5*11
C316	1	EA	25V 47UF 5*11
C317	1	EA	25V 47UF 5*11
C318	1	EA	25V 47UF 5*11

C319	1 EA	CH UP050 F223Z-
C320	1 EA	CH UP050 F223Z-
C321	1 EA	CH UP050 F223Z-
C322	1 EA	CH UP050 F223Z-
C323	1 EA	35V 10UF 5*11
C324	1 EA	35V 10UF 5*11
C325	1 EA	CH UP050 F223Z-
C326	1 EA	CH UP050 F223Z-
C327	1 EA	CCC 1H 180J 04
C328	1 EA	CCC 1H 180J 04
C329	1 EA	CH UP050 F473Z-
C330	1 EA	
C332	1 EA	00107-1003
C336	1 EA	25V 47UF 5*11
C337	1 EA	25V 47UF 5*11
C338	1 EA	HPE103J2AP050T
C351	1 EA	CH UP050 F103Z-
C353	1 EA	00107-1015
C354	1 EA	CH UP050 F223Z-
C357	1 EA	CH UP025 B102K-
C358	1 EA	CH UP025 B102K-
C359	1 EA	HPE683J2AP050T
C360	1 EA	HPE683J2AP050T
C361	1 EA	CH UP050 F473Z-
C363	1 EA	CH UP050 F103Z-
C364	1 EA	CH UP050 F103Z-
C365	1 EA	
C367	1 EA	CH UP050 F473Z-
C384	1 EA	CH EP025 B472M-
C385	1 EA	CH EP025 B472M-
C387	1 EA	CH UP025 B102K-
C388	1 EA	CH UP025 B102K-
C389	1 EA	CH UP050 F103Z-
C390	1 EA	00107-1003
C391	1 EA	CH UP050 F473Z-
C393	1 EA	CH UP050 F473Z-
C394	1 EA	00107-1003
C395	1 EA	CH UP050 F223Z-
C396	1 EA	00107-1015
C398	1 EA	HPE104J2AP050T
C399	1 EA	HPE104J2AP050T
C401	1 EA	CH UP025 B101K-
C402	1 EA	HPE393J2AP050T
C403	1 EA	CH UP025 B181K-
C404	1 EA	35V 10UF 5*11
C405	1 EA	
C406	1 EA	35V 10UF 5*11
C407	1 EA	35V 10UF 5*11

C408	1 EA	CH EP025 B222M-
C409	1 EA	35V 10UF 5*11
C411	1 EA	CH UP050 F223Z-
C412	1 EA	CH UP050 F223Z-
C451	1 EA	35V 10UF 5*11
C452	1 EA	35V 10UF 5*11
C453	1 EA	CH UP025CH220J-
C454	1 EA	CH UP025CH220J-
C455	1 EA	00107-1019
C456	1 EA	00107-1019
C457	1 EA	35V 10UF 5*11
C458	1 EA	35V 10UF 5*11
C459	1 EA	35V 10UF 5*11
C460	1 EA	35V 10UF 5*11
C461	1 EA	CH UP050 F223Z-
C462	1 EA	CH UP050 F223Z-
C463	1 EA	CH UP050 F223Z-
C464	1 EA	CH UP050 F223Z-
C465	1 EA	CH UP050 F103Z-
D301	1 EA	SLR-342YCTB7
D302	1 EA	SLR-342YCTB7
D303	1 EA	SLR-342YCTB7
D304	1 EA	SLR-342YCTB7
D305	1 EA	SLR-342YCTB7
D306	1 EA	SLR-342YCTB7
D307	1 EA	SLR-342YCTB7
D308	1 EA	SLR-325MCT31
D309	1 EA	SLR342VCTB7T089
D310	1 EA	ISS133(T/B)
D312	1 EA	SLR-325MCT31
D313	1 EA	ISS133(T/B)
D314	1 EA	SLR-342YCTB7
D315	1 EA	ZJ13BT(26MM T/B
D401	1 EA	ISS133(T/B)
D913	1 EA	ISS133(T/B)
D914	1 EA	1N4003 SRT
D915	1 EA	ZJ5.6BT(26MM T/
D916	1 EA	ZJ5.6BT(26MM T/
F900	1 EA	
F902	1 EA	
Q301	1 EA	KRC107M-AT/P
Q302	1 EA	KRC107M-AT/P
Q303	1 EA	KRC107M-AT/P
Q304	1 EA	KRC107M-AT/P
Q305	1 EA	KRC107M-AT/P
Q306	1 EA	KRC107M-AT/P
Q307	1 EA	KRC107M-AT/P
Q308	1 EA	KRC107M-AT/P

Q309	1 EA	KRC107M-AT/P
Q310	1 EA	KRA107M-AT/P
Q311	1 EA	KRC107M-AT/P
Q312	1 EA	KRA107M-AT/P
Q313	1 EA	KRA104M-AT/P
Q314	1 EA	KRA104M-AT/P
Q315	1 EA	KRA104M-AT/P
Q316	1 EA	KRA104M-AT/P
Q317	1 EA	KRC107M-AT/P
Q318	1 EA	KRC114M-AT/P
Q319	1 EA	KRC107M-AT/P
Q320	1 EA	KRA107M-AT/P
Q321	1 EA	KTA1267-Y-AT/P
Q322	1 EA	KRC107M-AT/P
Q323	1 EA	KTC3199-Y-AT/P
Q324	1 EA	KTC3204-Y-AT/P
Q325	1 EA	KTC3204-Y-AT/P
Q326	1 EA	KTA1272-Y-AT/P
Q327	1 EA	KTA1272-Y-AT/P
Q328	1 EA	KRC107M-AT/P
Q329	1 EA	KTC3199-Y-AT/P
Q330	1 EA	KRA107M-AT/P
Q401	1 EA	KTC3198-Y-AT/PJ
Q402	1 EA	KTC3198-Y-AT/PJ
Q901	1 EA	KTC3204-Y-AT/P
R301	1 EA	
R302	1 EA	
R305	1 EA	
R306	1 EA	
R309	1 EA	
R310	1 EA	
R311	1 EA	
R312	1 EA	
R313	1 EA	
R314	1 EA	
R315	1 EA	
R316	1 EA	
R317	1 EA	
R318	1 EA	
R319	1 EA	
R320	1 EA	
R321	1 EA	
R322	1 EA	
R326	1 EA	
R327	1 EA	
R328	1 EA	
R329	1 EA	
R330	1 EA	

R331	1 EA	
R332	1 EA	
R333	1 EA	
R334	1 EA	
R335	1 EA	
R336	1 EA	
R337	1 EA	
R338	1 EA	
R339	1 EA	
R340	1 EA	
R341	1 EA	
R342	1 EA	
R343	1 EA	
R344	1 EA	
R345	1 EA	
R346	1 EA	
R347	1 EA	
R348	1 EA	
R349	1 EA	
R350	1 EA	
R351	1 EA	
R352	1 EA	
R353	1 EA	
R354	1 EA	
R358	1 EA	
R359	1 EA	
R360	1 EA	
R361	1 EA	
R362	1 EA	
R363	1 EA	
R364	1 EA	
R381	1 EA	
R382	1 EA	
R383	1 EA	
R384	1 EA	
R385	1 EA	
R386	1 EA	
R390	1 EA	
R391	1 EA	
R401	1 EA	
R402	1 EA	
R412	1 EA	
R413	1 EA	
R414	1 EA	
R415	1 EA	
R417	1 EA	
R418	1 EA	
R419	1 EA	

R423	1 EA	
R424	1 EA	
R426	1 EA	
R427	1 EA	
R429	1 EA	
R451	1 EA	
R452	1 EA	
R453	1 EA	
R454	1 EA	
R455	1 EA	
R456	1 EA	
R457	1 EA	
R458	1 EA	
R459	1 EA	
R460	1 EA	
R461	1 EA	
R462	1 EA	
R463	1 EA	
R464	1 EA	
R465	1 EA	
R466	1 EA	
R917	1 EA	
R918	1 EA	
R919	1 EA	
R920	1 EA	
R921	1 EA	
R922	1 EA	
R923	1 EA	
R924	1 EA	
R925	1 EA	
R926	1 EA	
R928	1 EA	
S301	1 EA	00802-0005
S302	1 EA	00802-0005
S303	1 EA	00802-0005
S304	1 EA	00802-0005
	1 EA	
	5 G	
	10 G	
	1 G	
BK01	1 EA	ALL MODEL
BK02	1 EA	ALL MODEL
BK03	1 EA	ALL MODEL
BN02	1 EA	
BN03	1 EA	
BN04	1 EA	
BN06	1 EA	
BN07	1 EA	

BN09	1 EA	
BN10	1 EA	
BN11	1 EA	
BN12	1 EA	
BN21	1 EA	
BN23	1 EA	
BN42	1 EA	
BN44	1 EA	
BN93	1 EA	
CN01	1 EA	YMW025-04R
CN07	1 EA	YMW025-03R
CN10	1 EA	YMW025-04R
CN11	1 EA	YMW025-03R
CN13	1 EA	
CN14	1 EA	
CN15	1 EA	
CN18	1 EA	
CN21	1 EA	
CN23	1 EA	YMW025-03R
CN42	1 EA	
CN43	1 EA	
C381	1 EA	25V 1000UF 10*2
C382	1 EA	DE2E3KH472MECB
C383	1 EA	DE2E3KH472MECB
IC31	1 EA	KA4558S
IC32	1 EA	KA4558S
IC33	1 EA	CD4066BM96
IC34	1 EA	TMP87PH47UG(ZO)
IC41	1 EA	KA4558S
IC42	1 EA	KA4558S
IC43	1 EA	KA4558S
IC94	1 EA	KIA7805API-U/PF
JK31	1 EA	RCA-215-11
JK32	1 EA	PJ-612AG-51
JK41	1 EA	PJ-612AG-51
JW18	1 EA	AG-680
JW22	1 EA	
JW45	1 EA	
JW91	1 EA	
JW92	1 EA	
JW93	1 EA	
OT91	1 EA	A302D0061P
RC31	1 EA	KSM603TH2E
RL31	1 EA	G6B-2214P-US DC
RL92	1 EA	9-1419125-8
SW71	1 EA	
S305	1 EA	220014
S306	1 EA	220014

S307	1 EA	SPUL19X1M071
S308	1 EA	
T001	1 EA	
VR31	1 EA	EWCEW6F02B54
VR32	1 EA	EWCEW6F02B54
VR33	1 EA	
VR41	1 EA	
VR71	1 EA	RK16812MG12E
X301	1 EA	
	31 EA	
	2 EA	00M51260308M0
	1 EA	
	1 EA	A-H500&A-R600
	0.02 M	ALL MODEL
	2 G	
	1 EA	
	EA	A4-95-2336
	EA	
	EA	
	1 EA	
	EA	A-R600
	EA	
	EA	
	1 EA	
	1 EA	
	1 EA	
	6 EA	
	2 EA	
	4 EA	
	1 EA	
	5 EA	ALL MODEL
	3 EA	ALL MODEL
	7 EA	
	6 EA	
	1 EA	EUR 16A 250V
	1 EA	
	2 EA	TD-3000
	2 EA	i MODEL
	1 EA	
	1 EA	29X7.7X19
	1 EA	
	1 EA	
	1 EA	
	1 EA	A-R600
C101	1 EA	CCC 1H 180J 04
C102	1 EA	CCC 1H 180J 04
C103	1 EA	KCKR1H151KB
C104	1 EA	KCKR1H151KB

C105	1 EA	CCC 1H 220J 04
C106	1 EA	CCC 1H 220J 04
C107	1 EA	HPE102J2AP050T
C108	1 EA	HPE102J2AP050T
C109	1 EA	HPE562J2AP050T
C110	1 EA	HPE562J2AP050T
C111	1 EA	HPE223J2AP050T
C112	1 EA	HPE223J2AP050T
C113	1 EA	00107-1019
C114	1 EA	00107-1019
C115	1 EA	25V 47UF 5*11
C116	1 EA	25V 47UF 5*11
C117	1 EA	CH UP050 F223Z-
C118	1 EA	CH UP050 F223Z-
C119	1 EA	25V 47UF 5*11
C120	1 EA	25V 47UF 5*11
C121	1 EA	CC0 1H 101J 05
C122	1 EA	CC0 1H 101J 05
C123	1 EA	CC0 1H 101J 05
C124	1 EA	CC0 1H 101J 05
C125	1 EA	CC0 1H 101J 05
C126	1 EA	CC0 1H 101J 05
C127	1 EA	CC0 1H 101J 05
C128	1 EA	CC0 1H 101J 05
C129	1 EA	CC0 1H 101J 05
C130	1 EA	CC0 1H 101J 05
C131	1 EA	CC0 1H 101J 05
C132	1 EA	CC0 1H 101J 05
C133	1 EA	CC0 1H 101J 05
C134	1 EA	CC0 1H 101J 05
C135	1 EA	CC0 1H 101J 05
C136	1 EA	CC0 1H 101J 05
C137	1 EA	50V 2.2UF 5*11
C138	1 EA	50V 2.2UF 5*11
C139	1 EA	50V 2.2UF 5*11
C140	1 EA	50V 2.2UF 5*11
C141	1 EA	
C143	1 EA	CH UP050 F223Z-
C144	1 EA	CH UP050 F223Z-
C145	1 EA	25V 47UF 5*11
C146	1 EA	25V 47UF 5*11
C147	1 EA	CKB 1H 181K 04
C201	1 EA	00107-1019
C202	1 EA	00107-1019
C205	1 EA	CH UP050 F103Z-
C206	1 EA	CH UP050 F103Z-
C207	1 EA	CH UP050 F103Z-
C208	1 EA	CH UP050 F103Z-

C209	1 EA	25V 47UF 5*11
C210	1 EA	00107-1001
C211	1 EA	
C212	1 EA	
C213	1 EA	00107-1003
C214	1 EA	25V 47UF 5*11
C401	1 EA	00107-1019
C402	1 EA	00107-1019
C403	1 EA	CCC 1H 030C 04
C404	1 EA	CCC 1H 030C 04
C405	1 EA	KCKR1H561KB
C406	1 EA	KCKR1H561KB
C407	1 EA	HPE332J2AP050T
C408	1 EA	HPE332J2AP050T
C409	1 EA	
C410	1 EA	
C411	1 EA	
C412	1 EA	
C413	1 EA	CCC 1H 120J 04
C414	1 EA	CCC 1H 120J 04
C415	1 EA	HPE473J2AP050T
C416	1 EA	HPE473J2AP050T
C417	1 EA	HPE102J2AP050T
C418	1 EA	HPE102J2AP050T
C419	1 EA	00107-1019
C420	1 EA	00107-1019
C501	1 EA	00107-1019
C502	1 EA	00107-1019
C503	1 EA	CH UP025 B391K-
C504	1 EA	CH UP025 B391K-
C505	1 EA	CCC 1H 120J 04
C506	1 EA	CCC 1H 120J 04
C507	1 EA	CCC 1H 030C 04
C508	1 EA	CCC 1H 030C 04
C509	1 EA	25V 47UF 5*11
C510	1 EA	25V 47UF 5*11
C511	1 EA	HPE473J2AP050T
C512	1 EA	HPE473J2AP050T
C513	1 EA	CCO 1H 221J 05
C514	1 EA	CCO 1H 221J 05
C515	1 EA	00107-1015
C516	1 EA	00107-1015
C517	1 EA	00107-1031
C518	1 EA	00107-1031
C519	1 EA	25V 47UF 5*11
C520	1 EA	25V 47UF 5*11
C521	1 EA	00107-1031
C522	1 EA	00107-1031

C523	1 EA	56PF 50V J
C524	1 EA	56PF 50V J
C525	1 EA	CCC1H 100D 04 F
C526	1 EA	CCC1H 100D 04 F
C527	1 EA	00107-1031
C528	1 EA	00107-1031
C529	1 EA	CCC 1H 220J 04
C530	1 EA	CCC 1H 220J 04
C531	1 EA	CCC 1H 220J 04
C532	1 EA	CCC 1H 220J 04
C533	1 EA	SMS 100V 10UF 6
C534	1 EA	SMS 100V 10UF 6
C535	1 EA	SMS 100V 10UF 6
C536	1 EA	SMS 100V 10UF 6
C537	1 EA	CC0 1H 101J 05
C538	1 EA	CC0 1H 101J 05
C539	1 EA	CC0 1H 101J 05
C540	1 EA	CC0 1H 101J 05
C541	1 EA	KCKR1H561KB
C542	1 EA	KCKR1H561KB
C543	1 EA	CH UP050 F103Z-
C544	1 EA	CH UP050 F103Z-
C907	1 EA	HPE222J2AP050T
C908	1 EA	HPE222J2AP050T
C913	1 EA	HPE222J2AP050T
C914	1 EA	HPE222J2AP050T
C915	1 EA	HPE223J2AP050T
C916	1 EA	HPE223J2AP050T
C918	1 EA	00107-1003
C919	1 EA	
C920	1 EA	35V 100UF 6.3*1
C921	1 EA	
C922	1 EA	35V 100UF 6.3*1
C923	1 EA	
C924	1 EA	50V 100UF 8*11.
C925	1 EA	50V 100UF 8*11.
C926	1 EA	
C927	1 EA	
C928	1 EA	50V 100UF 8*11.
C929	1 EA	50V 100UF 8*11.
C930	1 EA	HPE103J2AP050T
C931	1 EA	HPE103J2AP050T
C932	1 EA	HPE103J2AP050T
C933	1 EA	HPE103J2AP050T
C935	1 EA	HPE473J2AP050T
C936	1 EA	HPE473J2AP050T
C937	1 EA	HPE102J2AP050T
C938	1 EA	HPE102J2AP050T

C939	1 EA	CH UP025SL560J-
C940	1 EA	CH UP025SL560J-
C941	1 EA	CH UP050 F223Z-
C942	1 EA	CH UP050 F223Z-
C943	1 EA	HPE104J2AP050T
D201	1 EA	ISS133(T/B)
D202	1 EA	ISS133(T/B)
D203	1 EA	ISS133(T/B)
D204	1 EA	ISS133(T/B)
D205	1 EA	ISS133(T/B)
D206	1 EA	ZJ6.2BT(26MM T/
D207	1 EA	ISS133(T/B)
D208	1 EA	ISS133(T/B)
D209	1 EA	ISS133(T/B)
D210	1 EA	ISS133(T/B)
D211	1 EA	ISS133(T/B)
D212	1 EA	ISS133(T/B)
D401	1 EA	ISS133(T/B)
D402	1 EA	ISS133(T/B)
D403	1 EA	ISS133(T/B)
D404	1 EA	ISS133(T/B)
D405	1 EA	ISS133(T/B)
D406	1 EA	ISS133(T/B)
D407	1 EA	ISS133(T/B)
D408	1 EA	ISS133(T/B)
D501	1 EA	ZJ6.2BT(26MM T/
D502	1 EA	ZJ6.2BT(26MM T/
D503	1 EA	ZJ6.2BT(26MM T/
D504	1 EA	ZJ6.2BT(26MM T/
D505	1 EA	ISS133(T/B)
D506	1 EA	ISS133(T/B)
D507	1 EA	ISS133(T/B)
D508	1 EA	ISS133(T/B)
D509	1 EA	ISS133(T/B)
D510	1 EA	ISS133(T/B)
D511	1 EA	ISS133(T/B)
D512	1 EA	ISS133(T/B)
D513	1 EA	ISS133(T/B)
D514	1 EA	ISS133(T/B)
D515	1 EA	ISS133(T/B)
D516	1 EA	ISS133(T/B)
D517	1 EA	ISS133(T/B)
D518	1 EA	ISS133(T/B)
D519	1 EA	ISS133(T/B)
D520	1 EA	ISS133(T/B)
D521	1 EA	ISS133(T/B)
D522	1 EA	ISS133(T/B)
D523	1 EA	ISS133(T/B)

D524	1 EA	ISS133(T/B)
D525	1 EA	ISS133(T/B)
D526	1 EA	ISS133(T/B)
D527	1 EA	ISS133(T/B)
D528	1 EA	ISS133(T/B)
D529	1 EA	ISS133(T/B)
D530	1 EA	ISS133(T/B)
D531	1 EA	ISS133(T/B)
D532	1 EA	ISS133(T/B)
D533	1 EA	ISS133(T/B)
D534	1 EA	ISS133(T/B)
D902	1 EA	1N4003T/P
D903	1 EA	1N4003T/P
D904	1 EA	1N4003T/P
D905	1 EA	1N4003T/P
D906	1 EA	1N4003T/P
D907	1 EA	1N4003T/P
D908	1 EA	1N4003T/P
D909	1 EA	1N4003T/P
D910	1 EA	ZJ30BT(26MM T/B)
D911	1 EA	ZJ30BT(26MM T/B)
D916	1 EA	ISS133(T/B)
Q101	1 EA	KTC2874-B-AT/P
Q102	1 EA	KTC2874-B-AT/P
Q105	1 EA	KTC2874-B-AT/P
Q106	1 EA	KTC2874-B-AT/P
Q201	1 EA	KTC3198-Y-AT/PJ
Q202	1 EA	KTC3198-Y-AT/PJ
Q203	1 EA	KTC3198-Y-AT/PJ
Q204	1 EA	KTC3198-Y-AT/PJ
Q205	1 EA	KRA107M-AT/P
Q206	1 EA	KRA107M-AT/P
Q207	1 EA	KRA107M-AT/P
Q208	1 EA	KTC3203-Y-AT/PF
Q209	1 EA	KTC3203-Y-AT/PF
Q210	1 EA	KTC3198-Y-AT/PJ
Q211	1 EA	KRA107M-AT/P
Q212	1 EA	KTC3198-Y-AT/PJ
Q213	1 EA	KTA1272-Y-AT/P
Q401	1 EA	KTA1268-GR-AT/P
Q402	1 EA	KTA1268-GR-AT/P
Q403	1 EA	KTA1268-GR-AT/P
Q404	1 EA	KTA1268-GR-AT/P
Q405	1 EA	KTC3200-GR-AT/P
Q406	1 EA	KTC3200-GR-AT/P
Q407	1 EA	KTA1266-Y-AT/PJ
Q408	1 EA	KTA1266-Y-AT/PJ
Q409	1 EA	KTC3198-Y-AT/PJ

Q410	1 EA	KTC3198-Y-AT/PJ
Q501	1 EA	KTC2874-B-AT/P
Q502	1 EA	KTC2874-B-AT/P
Q503	1 EA	KTC2874-B-AT/P
Q504	1 EA	KTC2874-B-AT/P
Q505	1 EA	2SK117-BL(TPE2,
Q506	1 EA	2SK117-BL(TPE2,
Q507	1 EA	2SK117-BL(TPE2,
Q508	1 EA	2SK117-BL(TPE2,
Q901	1 EA	KTC1027Y
Q902	1 EA	KSA916-YTA
R101	1 EA	
R102	1 EA	
R103	1 EA	
R104	1 EA	
R105	1 EA	
R106	1 EA	
R107	1 EA	
R108	1 EA	
R109	1 EA	
R110	1 EA	
R111	1 EA	
R112	1 EA	
R113	1 EA	
R114	1 EA	
R115	1 EA	
R116	1 EA	
R117	1 EA	150 OHM 1/4W J
R118	1 EA	150 OHM 1/4W J
R119	1 EA	
R120	1 EA	
R121	1 EA	
R122	1 EA	
R123	1 EA	
R124	1 EA	
R125	1 EA	
R126	1 EA	
R127	1 EA	
R128	1 EA	
R129	1 EA	
R130	1 EA	
R131	1 EA	
R132	1 EA	
R133	1 EA	
R134	1 EA	
R135	1 EA	
R136	1 EA	
R137	1 EA	

R138	1 EA	
R139	1 EA	
R140	1 EA	
R141	1 EA	
R142	1 EA	
R143	1 EA	
R144	1 EA	
R145	1 EA	
R146	1 EA	
R149	1 EA	
R150	1 EA	
R151	1 EA	
R152	1 EA	
R155	1 EA	
R156	1 EA	
R157	1 EA	
R158	1 EA	
R171	1 EA	
R172	1 EA	
R173	1 EA	
R175	1 EA	
R176	1 EA	
R201	1 EA	
R202	1 EA	
R203	1 EA	
R204	1 EA	
R205	1 EA	
R206	1 EA	
R207	1 EA	
R208	1 EA	
R209	1 EA	
R210	1 EA	
R211	1 EA	
R212	1 EA	
R213	1 EA	
R214	1 EA	
R215	1 EA	
R216	1 EA	
R217	1 EA	
R218	1 EA	
R219	1 EA	
R220	1 EA	
R221	1 EA	
R222	1 EA	
R223	1 EA	
R224	1 EA	
R225	1 EA	
R226	1 EA	

R227	1 EA	
R228	1 EA	
R229	1 EA	
R230	1 EA	
R235	1 EA	
R236	1 EA	
R401	1 EA	
R402	1 EA	
R403	1 EA	
R404	1 EA	
R405	1 EA	
R406	1 EA	
R407	1 EA	
R408	1 EA	
R409	1 EA	
R410	1 EA	
R411	1 EA	
R412	1 EA	
R413	1 EA	
R414	1 EA	
R415	1 EA	
R416	1 EA	
R417	1 EA	
R418	1 EA	
R419	1 EA	
R420	1 EA	
R421	1 EA	
R422	1 EA	
R423	1 EA	
R424	1 EA	
R425	1 EA	
R426	1 EA	
R427	1 EA	
R428	1 EA	
R429	1 EA	
R430	1 EA	
R431	1 EA	
R432	1 EA	
R433	1 EA	
R434	1 EA	
R501	1 EA	
R502	1 EA	
R503	1 EA	
R504	1 EA	
R505	1 EA	
R506	1 EA	
R507	1 EA	
R508	1 EA	

R509	1 EA	
R510	1 EA	
R511	1 EA	
R512	1 EA	
R513	1 EA	
R514	1 EA	
R515	1 EA	
R516	1 EA	
R517	1 EA	
R518	1 EA	
R519	1 EA	
R520	1 EA	
R521	1 EA	
R522	1 EA	
R523	1 EA	
R524	1 EA	
R525	1 EA	
R526	1 EA	
R527	1 EA	
R528	1 EA	
R529	1 EA	
R530	1 EA	
R531	1 EA	
R532	1 EA	
R533	1 EA	
R534	1 EA	
R535	1 EA	
R536	1 EA	
R537	1 EA	360 OHM 1/5W J
R538	1 EA	360 OHM 1/5W J
R539	1 EA	
R540	1 EA	
R541	1 EA	
R542	1 EA	
R543	1 EA	
R544	1 EA	
R567	1 EA	
R568	1 EA	
R569	1 EA	
R570	1 EA	
R911	1 EA	
R912	1 EA	
R915	1 EA	
R916	1 EA	
R917	1 EA	
R918	1 EA	
R920	1 EA	
R921	1 EA	

R922	1 EA	
	1 EA	
	1 EA	
	1 EA	A-R600EUR
	1 EA	
	1 EA	
	2 EA	
	1 EA	AA-900/AG-V8525
	1 G	
	1 EA	
	1 EA	A-R600
	8 EA	00M51260308M0
	6 EA	
Q523	1 EA	KTD2058-Y-U/PF
Q524	1 EA	KTD2058-Y-U/PF
Q533	1 EA	2SC3519A
Q534	1 EA	2SC3519A
Q535	1 EA	2SA1386A
Q536	1 EA	2SA1386A
TW01	1 EA	NTC5D103
	1 EA	ALL MODEL
	1 EA	
	15 G	
	17 G	
	3 G	
	5 G	
BN01	1 EA	
BN05	1 EA	
BN13	1 EA	
BN43	1 EA	
CN02	1 EA	00906-0014
CN03	1 EA	00906-0017
CN04	1 EA	YMW025-04R
CN05	1 EA	YMW025-04R
CN06	1 EA	
CN09	1 EA	
CN12	1 EA	
CN21	1 EA	YMW025-02R
CN44	1 EA	YMW025-04R
C901	1 EA	CKB2H103K16BW1
C902	1 EA	CKB2H103K16BW1
C903	1 EA	CKB2H103K16BW1
C904	1 EA	CKB2H103K16BW1
C905	1 EA	
C906	1 EA	
C909	1 EA	
C910	1 EA	
C911	1 EA	

C912	1 EA	
D901	1 EA	
	1 EA	A-R600
	1 EA	
	1 EA	KBPC2504WF
	0.3 G	
IC01	1 EA	NJU7312AL
IC02	1 EA	KA4558S
IC91	1 EA	
	1 EA	ALL MODEL
	1 EA	00M51260308M0
	1 EA	KA7815ETU
	1 G	
IC92	1 EA	
	1 EA	ALL MODEL
	1 EA	00M51260308M0
	1 EA	KA7915TU
	0.2 G	
IC93	1 EA	KMY1A025
	1 EA	ALL MODEL
	1 EA	00M51260308M0
	1 EA	KIA7805API-U/PF
	0.2 G	
JK01	1 EA	RCA-610DG-05
JK02	1 EA	RCA-601DA-05
JK03	1 EA	RCA-601DA-05
JW20	1 EA	
L501	1 EA	
L502	1 EA	
Q411	1 EA	2SC2911S
Q412	1 EA	2SC2911S
Q413	1 EA	2SA1209S/T
Q414	1 EA	2SA1209S/T
Q509	1 EA	KTC3200-GR-AT/P
Q510	1 EA	KTC3200-GR-AT/P
Q511	1 EA	KTC3200-GR-AT/P
Q512	1 EA	KTC3200-GR-AT/P
Q513	1 EA	KTA1267-Y-AT/P
Q514	1 EA	KTA1267-Y-AT/P
Q515	1 EA	KTA1267-Y-AT/P
Q516	1 EA	KTA1267-Y-AT/P
Q517	1 EA	2SA1209S/T
Q518	1 EA	2SA1209S/T
Q519	1 EA	2SC2911S
Q520	1 EA	2SC2911S
Q521	1 EA	2SC2911S
Q522	1 EA	2SC2911S
Q525	1 EA	2SC3423-0(Q,H)

Q526	1 EA	2SC3423-0(Q,H)
Q527	1 EA	2SA1360-O(Q,H)
Q528	1 EA	2SA1360-O(Q,H)
Q529	1 EA	KTD2061-Y-U/PF
Q530	1 EA	KTD2061-Y-U/PF
Q531	1 EA	KTB1369-Y-U/PF
Q532	1 EA	KTB1369-Y-U/PF
RL01	1 EA	9-1419125-8
RL02	1 EA	9-1419125-8
RL03	1 EA	9-1419125-8
RL04	1 EA	9-1419125-8
R549	1 EA	
R550	1 EA	
R551	1 EA	
R552	1 EA	
R553	1 EA	
R554	1 EA	
R555	1 EA	
R556	1 EA	
R557	1 EA	
R558	1 EA	
R559	1 EA	0.22 OHM 5W K
R560	1 EA	0.22 OHM 5W K
R561	1 EA	0.22 OHM 5W K
R562	1 EA	0.22 OHM 5W K
R563	1 EA	
R564	1 EA	
R565	1 EA	
R566	1 EA	
R575	1 EA	
R576	1 EA	
R901	1 EA	
R902	1 EA	
R903	1 EA	
R904	1 EA	
R905	1 EA	
R906	1 EA	
R907	1 EA	
R908	1 EA	
R909	1 EA	
R910	1 EA	
R913	1 EA	
SP01	1 EA	JB-405E-02
SP02	1 EA	PTB-408SA-030
TP01	1 EA	YMW025-02R
TP02	1 EA	YMW025-02R
VR51	1 EA	KVSF637TC471
VR52	1 EA	KVSF637TC471

	1 EA	
	17 EA	
	9 EA	
	8 EA	
	4 EA	00M51260308M0
	4 EA	
	3 EA	
	2 EA	
	7 EA	
	1 EA	A-R600UK
	2 G	
	2 EA	
	1 EA	
	1 EA	
F902	1 EA	
	0.12 M	
	1 EA	STA-3760/50
	1 EA	
	8 EA	
	1 EA	A-R600EURCC
	1 EA	A-R600EURCC
	2 EA	DVR100
	1 EA	DVD-310
	0.12 M	SONY(TR-4070)
	2 EA	ALL MODEL
	1 EA	
	2 EA	00D3940012003
	1 EA	
DED	1 EA	
	3 EA	
	1 EA	
	1 EA	
	1 EA	
	4 EA	SH08M790BO
	0.2 M	
	1 M	