

159

C/P

TASCAM

TEAC Professional Division

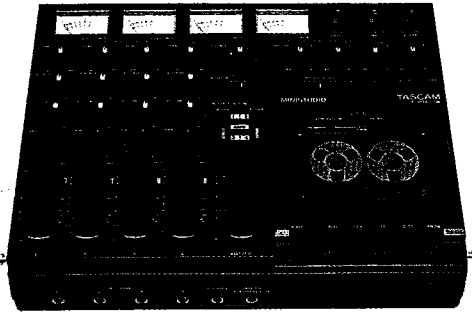

3076
3-80

SERVICE MANUAL

MINISTUDIO PORTA ONE

SOUND SERVICE CENTER
21525 SHERMAN WAY
EMMOGA PARK, CALIF. 91302

CONTENTS

1. SPECIFICATIONS AND SERVICE DATA	3
2. FEATURES AND CONTROLS	4
3. CIRCUIT DESCRIPTION	13
3-1 General	13
3-2 Control Circuit	15
3-3 Power Supply Circuit (Power Mute Circuit)	17
3-4 Mixer Circuit	18
3-5 Record and Playback Circuit	20
4. MAJOR PARTS LOCATION	24
5. MAIN MAINTENANCE EQUIPMENTS	25
6. MEASUREMENT CONDITIONS FOR MAINTENANCE	26
7. REMOVAL OF MAJOR PARTS	27
8. MECHANICAL CHECKS AND ADJUSTMENTS	28
8-1 Capstan Assembly Thrust	28
8-2 Pinch Roller Pressure	28
8-3 Take-up Torque	28
8-4 Tape Travel	29
8-5 Head Azimuth	29
8-6 Tape Speed	29
8-7 Wow and Flutter	30
9. MIXIER SECTION SIGNAL CHECKS AND ADJUSTMENTS	30
10. RECORD/PLAYBACK AMPLIFIER CHARACTERISTICS	32
10-1 Playback Level	33
10-2 Playback Frequency Response	33
10-3 Dummy Coils	33
10-4 Bias Trap	33
10-5 Bias Voltage	34
10-6 Record Level	34
10-7 Overall Frequency Response	34
10-8 Overall Distortion	34
10-9 Overall SN Ratio	35
10-10 Erasing Ratio	35
10-11 Crosstalk Between Channels	35
10-12 Sync Crosstalk	35
10-13 Voltage of DBX Amplifiers	35
11. EXPLODED VIEW AND PARTS LIST	36
12. IC INTERNAL CIRCUIT	44
13. P.C. BOARDS AND PARTS LIST	45
R/P Ampl. P.C.B. Ass'y, Control P.C.B. Ass'y	
Mixing Ampl. P.C.B. Ass'y, Tape Cue Ampl. P.C.B. Ass'y, Switch P.C.B. Ass'y	
Schematic Diagrams	Attached

1. SPECIFICATIONS AND SERVICE DATA

MECHANICAL CHARACTERISTICS

Tape	Compact cassette C-30 to C-90, 70 μ s, Hi-bias (Type II) tape
Track Format	4-track, 4-channel
Head Configuration	2 heads (erase and record/reproduce)
Motor	1 servo motor
Tape Speed	4.8 cm/s (1-7/8 ips) \pm 1%
Pitch Control	\pm 15%
Fast Winding Time	Approx. 100 seconds for C-60
Dimensions (W x H x D)	330 x 250 x 70 mm (13" x 9-13/16" x 2-3/4")
Weight	3.0 kg (6.6 lbs) without batteries 3.5 kg (7.7 lbs) with batteries

SERVICE DATA

Tape Speed:	
Speed Variation	3,000 Hz \pm 45 Hz
Speed Variation Width	Within 30 Hz
Pitch Control:	
Minimum	Less than 2550 Hz
Maximum	Higher than 3450 Hz
Take-up Torque:	
Playback & Record	35 ~ 70 g-cm
F. FWD, REW	70 ~ 160 g-cm
Pinch Roller Pressure	300 ~ 500 g
Wow & Flutter	0.1% RMS Playback Method (weighted)
Overall Frequency Response	Refer to 10-7
Overall Distortion	Refer to 10-8
Overall S/N	Refer to 10-9
Erasing Ratio	More than 65 dB

ELECTRICAL CHARACTERISTICS

MIXER SECTION

Mic/Line Input	
Source Impedance	10k ohms or less
Input Impedance	10k ohms
Nominal Input Level	Mic, -50 dBV (3.16mV), Trim Max. Line, -10 dBV (0.3V), Trim Min.
Minimum Input Level	-58 dBV (1.26mV)
Maximum Input Level	-2 dBV (0.8mV)
Line Output	
Output Impedance	1k ohms
Nominal Load Impedance	50k ohms
Minimum Load Impedance	10k ohms
Nominal Output Level	-10 dBV (0.3V)
Headphone Output	
Nominal Load Impedance	8 ohm, stereophones
Maximum Output Level	100mW
Equalizer	
Type	Shelving
Frequencies	LOW: 100 Hz HIGH: 10 kHz
Boost/Cut Range	\pm 10 dB

RECORDER SECTION

Record Channel	2 (2 dbx II NR, switchable)
Playback Channel	4 (4 dbx II NR, switchable)
Bias Frequency	60 kHz
Equalization	3180 μ s + 70 μ s
Record Level Calibration	160 nWb/m tape flux level (0 VU reference)
Tape Out	
Output Impedance	1k ohms
Nominal Load Impedance	50k ohms
Minimum Load Impedance	10k ohms
Nominal Output Level	-10 dBV (0.3V)
Power Requirements	DC 11 - 15V, 350mA max.
Batteries	SUM-2, "C" size, R14 or equivalent

NOTES:

- In these specifications, 0 dBV is referenced to 1.0 Volt. Actual voltage levels are also given in parenthesis (0.316V for -10 dBV is rounded off and given as 0.3V).
- Changes in specifications and features may be made without notice or obligation.

• dbx Noise Reduction system made under license from dbx, Incorporated. The name "dbx" and the dbx symbol are trademarks of dbx, Incorporated.

2. FEATURES AND CONTROLS

1 POWER switch and LED

Pressing it switches the PORTA ONE on and the LED lights, pressing it again turns the PORTA ONE off. When the PORTA ONE is used with batteries, this LED will blink when the batteries need to be replaced.

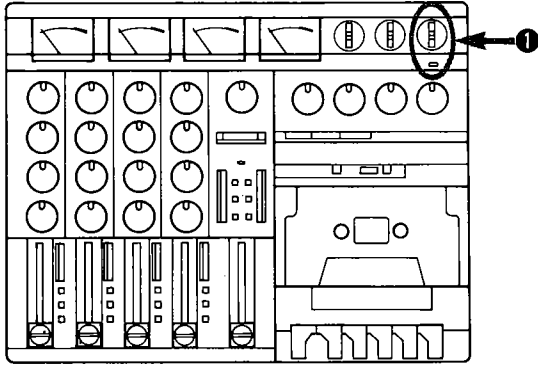

2 EXTERNAL DC IN Jack

This (DC IN) jack is to connect the AC power adaptor. When using the PORTA ONE for extended periods, we recommend use of the PS-P1 (optional) AC adaptor instead of batteries.

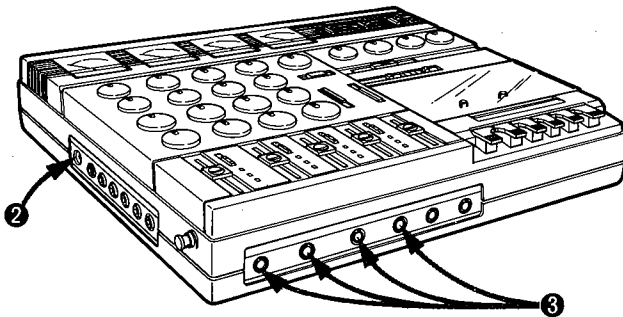

3 MIC/LINE Input Connector

This 1/4" phone jack accepts unbalanced signals from any type of microphone having any impedance from 150 ohms to 10,000 ohms. You can also connect any magnetic instrument pickup, electric guitar or bass, or an electronic keyboard. There is usually no need for a "direct box" or transformer. However, some situations may require such a device.

This applies primarily to mics used with cable runs exceeding 3 m (10 feet). Sometimes, the low power signal mics (and some instrument pickups) generate must be protected and isolated from other low power signals in the real world. Radio, power line hum, buzz, crackles

and switching noise when motors start up (do you have an air conditioner on your AC line or maybe an old fridge?) — all these unwanted signals must be kept out of the very high gain amplifiers that are needed to raise the mic signals to a working level. The balanced or 3-wire mic circuit and input isolation transformer become the only sure way to deal with these problems.

Here's how it works:

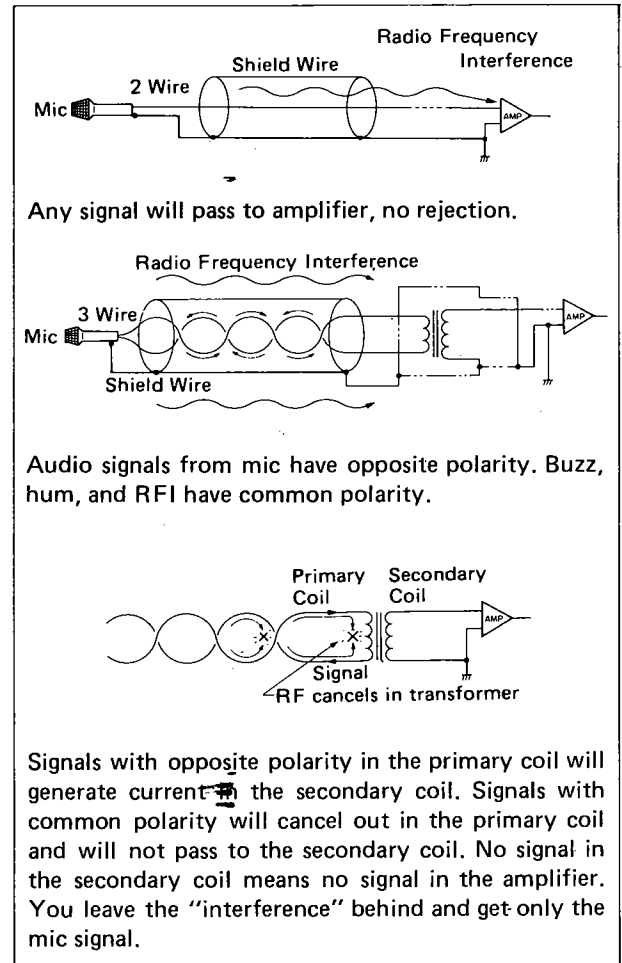

4 INPUT Select Switch

This switch has three positions.

down-MIC/LINE: Select the MIC/LINE input connector on the front panel of the PORTA ONE.

center-OFF: Acts as a "mute".

This "mute" can be useful in many ways. When used on MIC/LINE signals it will allow you to turn on a signal accurately without having to

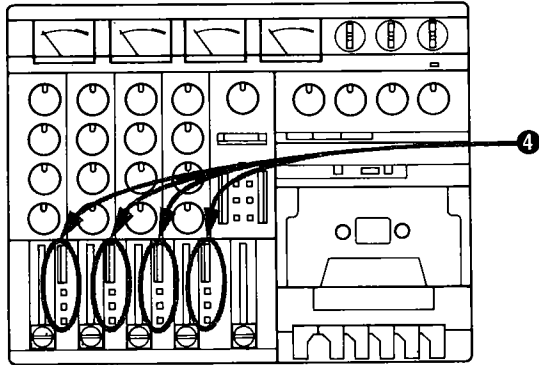

move the fader to a preset mark. This "drop-in" function with all controls preset can be used to edit out undesirable sections from a track when you are remixing. Prior to your final mix, the use of this mute function will allow you to hold all your preliminary mix settings including the level set by the fader, and still silence an input while you "fine tune" another.

up-TAPE: Selects an internal connection from the recorder's input channel 1 corresponding to tape track 1; channel 2 to track 2; channel 3 to track 3 and channel 4 to track 4. Nothing will be available at this switch point unless there are signals on the tape.

5 TRIM

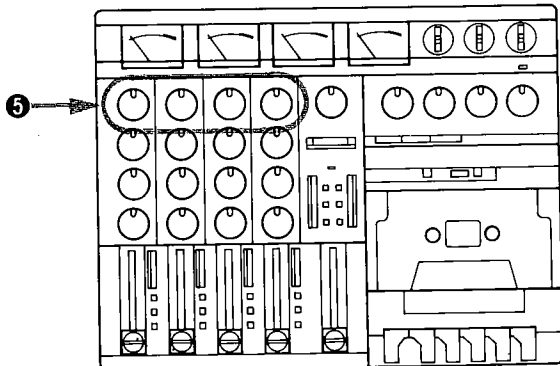

This control alters the gain of the first amplifier, it will affect the level of MIC/LINE signals but has no effect on the TAPE signals. The amount of increase or gain that the amplifier gives the signal is determined by TRIM control. The TRIM control allows you to adjust the

amplifier to handle a wide variety of signal levels. Turning the TRIM control clockwise (right) causes the amp to give more gain when working with mic's or softer sound sources. Turning the TRIM counterclockwise (left) reduces the amount of gain when working with line level signals or louder sound sources.

6 Input Fader

This linear, or slide, fader varies the amount of signal going from the input channel to the Left and Right (L/R) Program (PGM) Output Busses via the PAN control. This channel fader is the main mixing control for adjusting how much of the input appears at the output(s).

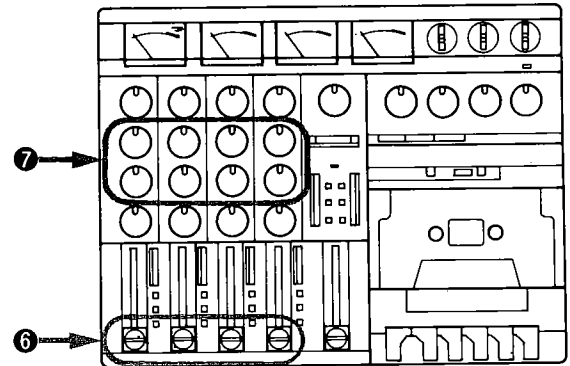

7 EQualizer

The equalizer or EQ is the circuitry that allows you to adjust the tonality of the signal going through the input channel. It is a two-knob type, with the upper knob allowing a boost or cut of 10 dB at 10 kHz for the high frequencies, and the lower knob allowing a boost or cut of 10 dB at 100 Hz for the low frequencies. They work similarly to the bass and treble knobs on other audio equipment.

We've included a chart of the frequency characteristics of some musical instruments so you can get a better idea of how these tone controls can be used to the best artistic advantage. Of course, using them and hearing the results will tell you exactly how they work.

⑧ PAN

The PAN control is used to assign (send) the input channel's signal to the PGM Output Busses. The PAN provides continuously variable assignment to the L PGM (Program) Output Buss (full counterclockwise rotation) and the R PGM Output Buss (full clockwise rotation). This allows you to make stereo mixes and locate an input channel's signal anywhere in the stereo panorama.

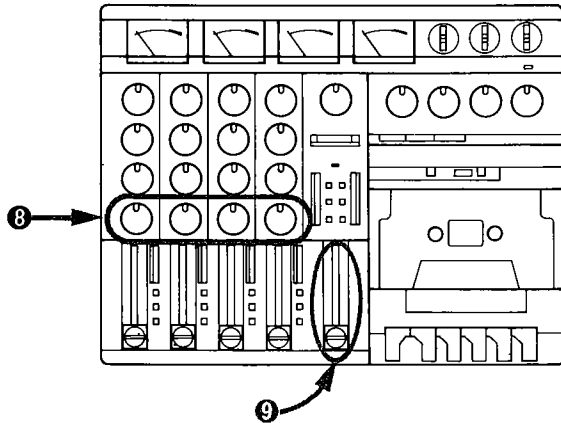

⑨ MASTER (L/R) Fader

This linear (slide) fader controls the level of the signal or mix of signals assigned to the L and R PGM Output Busses. It simultaneously adjusts the signal level at the:

1. LINE OUT jacks Left and Right.
2. The BUSS L/TRK 1 and BUSS R/TRK 2 meters when the PORTA ONE is in the Record Ready or Record modes.
3. RECORD FUNCTION select switch.
4. MONITOR switch/PHONES level control.

⑩ LINE OUT Jacks (L/R)

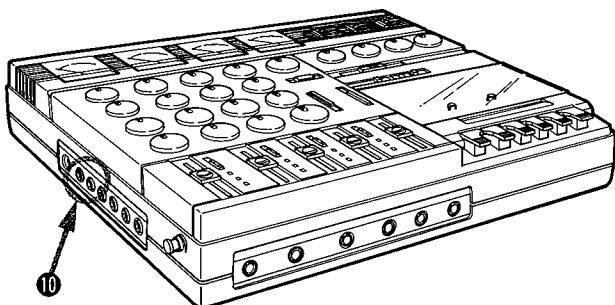

This pair of RCA jacks feed a line-level program mix (from the Left and Right PGM Busses) to a monitor amp or tape recorder. This is the same mix you hear in the headphones when the PORTA ONE's monitor select switch is in REMIX, except the LINE OUT level is controlled only by the L/R MASTER Fader and not by the PHONES control.

Caution: Never connect two PORTA ONE outputs directly together via a "Y" adaptor or similar method. Doing so would connect both output amps together leading to circuit failure.

⑪ TAPE CUE

These 4 knobs, corresponding to Tracks 1 through 4, are used to create a mono mix of any existing tracks (already recorded tracks) during playback. The Tape Cue mix is always fed to the MONITOR Select switch.

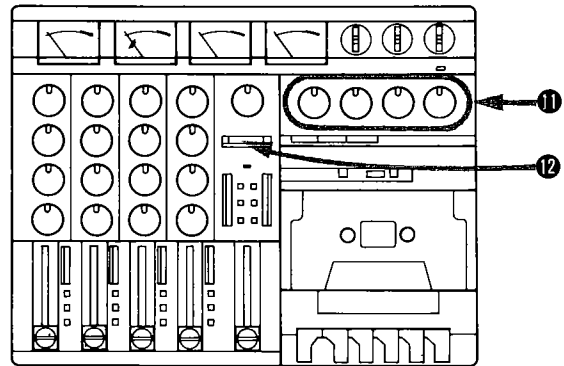

⑫ MONITOR (Headphones) Select Switch

What you will hear in the headphone circuit will be controlled by this switch.

REMIX — You will hear the stereo output of the L/R PGM Busses. The levels you will hear are affected by the settings of the MASTER L/R Fader and the PHONES level control. In this position the TAPE CUE controls have no effect on what you hear in the headphones.

CUE — You will hear a Mono combination of the MASTER L/R signal plus the Tape Cue signals, one for each track. The TAPE CUE controls have signals available to them only after the track has been recorded. To hear them you must be in the CUE (mono) mode.

13 PHONES

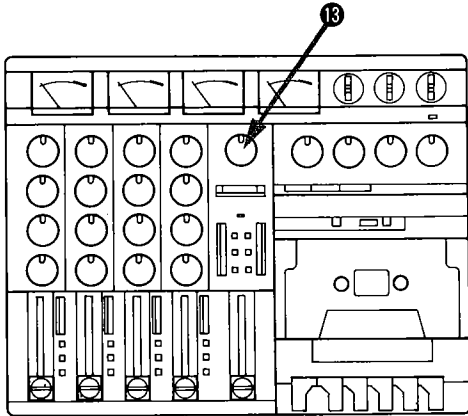

The PHONES control adjusts the overall level of your headphones, plugged into the front panel jack. Any change in the setting of the TRIM, Input Faders, MASTER Fader or the TAPE CUE controls will change the signal level in the phones.

Caution: MONO (2-WIRE) HEADPHONES WILL CAUSE CIRCUIT FAILURE. If your headphones have this connector, don't use them.

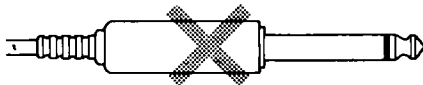

(1/4" phone 2-connector)

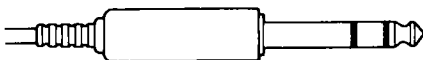

(1/4" phone 3-connector)

Your headphone connector must have 3 sections to be safe. While accidents do happen, and protection circuits have been built in, use of mono/2-wire headphones will eventually cause circuit failure (2 to 3 minutes). Using the 2-wire connector shorts out one of the amplifiers driving the headphones, which will cause it to burn out.

TRANSPORT SECTION

14 RESET and ZERO RETURN

The Tape Counter is useful for locating any specific point on a tape. The Tape Counter can be reset to 000 at any time by pressing the RESET button located to the right of the counter.

Being able to return to any desired point on a tape can be very helpful. If the ZERO RETURN button is depressed, the tape will automatically stop during REWIND when the Tape Counter reaches 000. All you have to do to return to a specific point is reset the Tape Counter to 000 at the point you wish to return to, and depress the ZERO RETURN button. The tape will always stop at that point when you use the REWIND function.

After the tape has stopped when using ZERO RETURN, pressing the REW button again starts rewinding beyond the 000 point. The tape will automatically stop at its beginning.

NOTE: ZERO RETURN works only in rewind, tape motion will not stop at 000 in the Fast Forward mode.

15 PLAY Button

Pressing this button places the transport in the PLAY mode. The end stop mechanism releases all functions when the tape reaches its end. Pressing the FF or REW button during playback will enable you to locate at high speed by monitoring the tape, a desired recorded portion or the end of a program.

NOTE: Monitoring the tape at a high speed will cause high level, very high-frequency audio signals to appear at the outputs. Be sure that you turn down the output/monitoring level prior to using this function, so that the headphones or speaker units will not be damaged by excess high frequency.

16 PAUSE Button

Disengages the pinch roller from the capstan while playing or recording a cassette, which causes the tape to stop running. The electronics remain engaged. To enter RECORD/PAUSE, press PAUSE, then REC. To resume playing or recording, press the PAUSE button again.

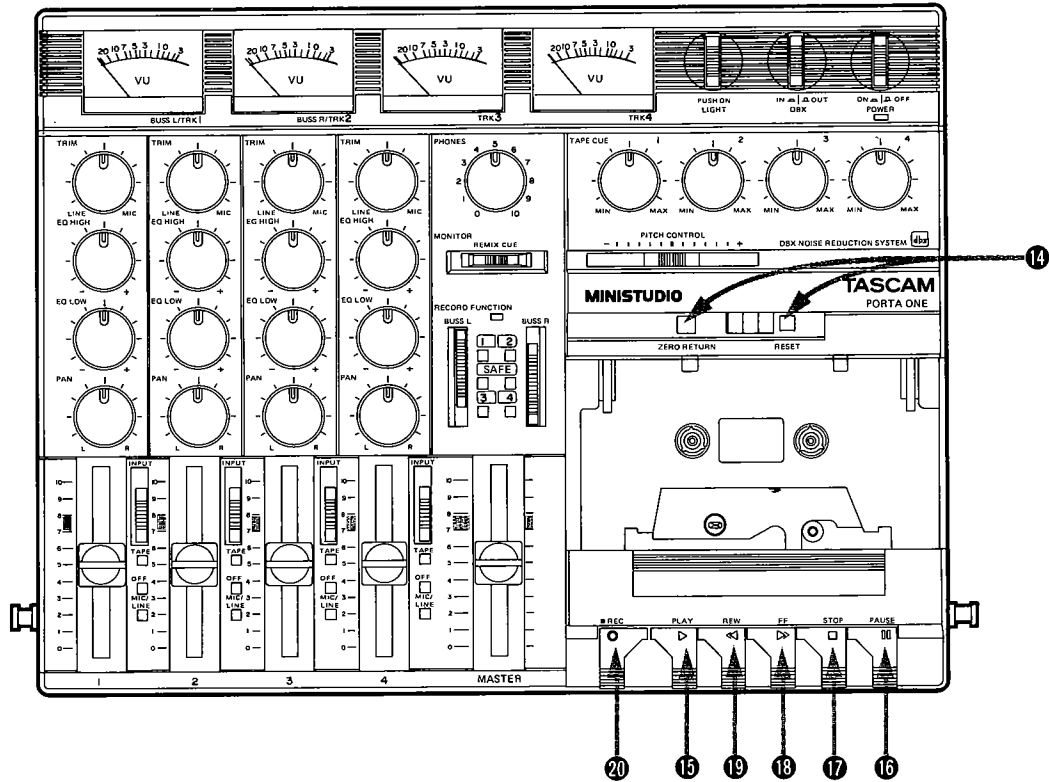

17 STOP Button

Pressing this button stops any tape motion, and cancels the Record mode.

18 FF Button

Pressing this button winds the tape forward at high speed. When the tape reaches its end, the transport will automatically stop.

19 REW Button

Pressing this button rewinds the tape at high speed. When the tape reaches its beginning, or when the ZERO RETURN stop position is reached, the transport will automatically stop.

20 REC Button

Pressing this button begins the recording process by activating the record electronics selected by the RECORD FUNCTION switches and starting tape motion. Recording cannot be done if both RECORD FUNCTION switches are set to the SAFE position or the record protection tabs are missing on a cassette. Check the RECORD FUNCTION switches or the cassette tabs if the PORTA ONE does not enter Record.

21 REMOTE PUNCH IN/OUT Jack

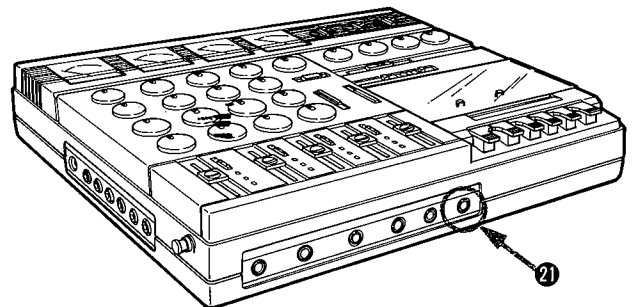

This 1/4" (6.3 mm) phone jack, on the front of the PORTA ONE, is for the optional RC-30P Remote Punch In/Out pedal. Whether you're a busy engineer, producer, or a musician with both hands on an instrument, there are those times when you can't drop what you're doing to press the RECORD button. You need a third hand! The RC-30P can be that third hand. It lets you punch in and out of RECORD with a tap of your foot.

NOTE: The RC-30P does NOT work in con-

junction with the REC button. If you enter the Record mode with the REC button you cannot terminate the Record mode with the RC-30P you must use the STOP button.

22 RECORD FUNCTION Switches

The PORTA ONE mixer has only two Output Busses. (Left and Right) which are internally connected to the RECORD FUNCTION switches. The Left switch assigns the L Buss to either Track 1 or Track 3 and Right switch, R Buss to either Tracks 2 or 4. Setting either of the RECORD FUNCTION switches to a track, makes the RECORD FUNCTION LED flash to indicate that the PORTA ONE is in "Record Ready" mode.

Switch Position	Buss L	Buss R	Indicator
UP	1	2	Red
Center	Safe	Safe	Green
Down	3	4	Red

23 RECORD FUNCTION LED

This LED indicates any of the tracks' record status ("Record Safe", "Record Ready" or "Record" mode):

- a). LED off: "Record Safe" mode – no recording can take place.
- b). LED blinks: "Record Ready" mode – indicates that one or both busses have been assigned to a track. Whether the tape is stopped or in play, the PORTA ONE is ready to go into record, but not yet recording.
- c). LED on: Record or Record/Pause – the recorder is recording or is ready to begin recording by releasing the PAUSE button.

24 LIGHT Switch

When you use the PORTA ONE with batteries, the meters will not light. This is to save battery power. If necessary, you can light the meters by depressing the LIGHT switch button. When using the PS-P1 AC adaptor, the meters will light.

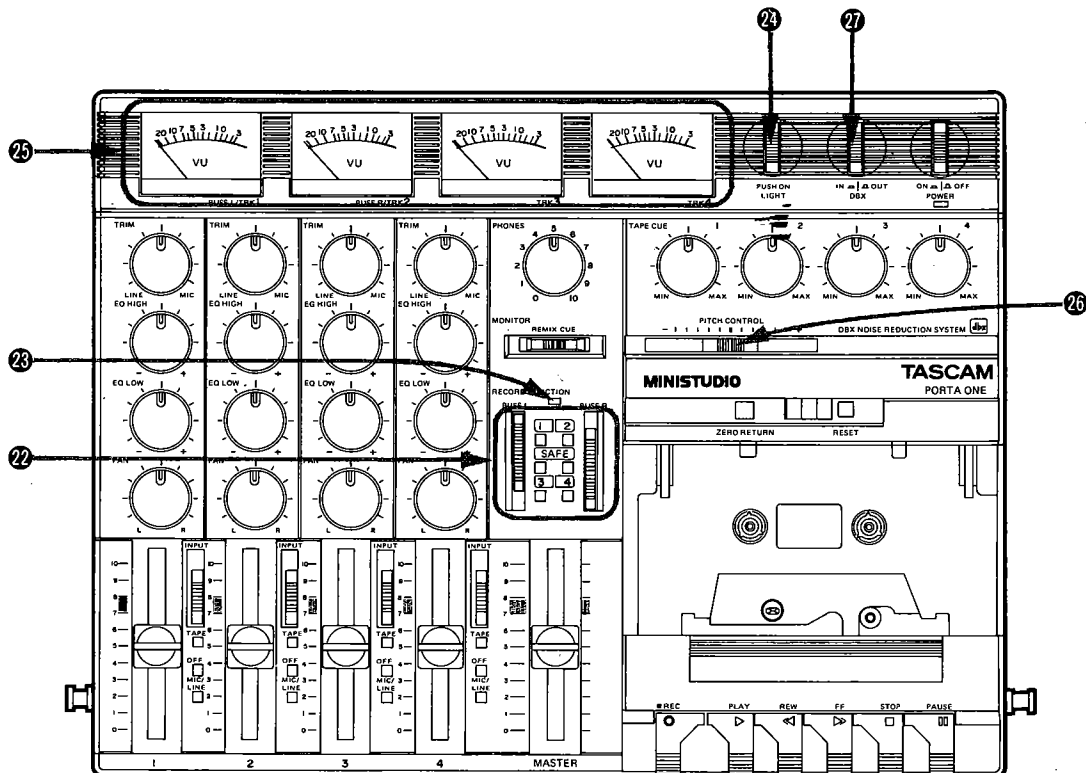

④ VU Meters and Switching Logic

The PORTA ONE has VU (Volume Unit) meters. They respond to the average signal level and do NOT show peak levels. Most percussive material, kick drum, latin percussion, such as castanets, generates high peak or transient signals, that can be much as 20 dB louder than the "average" signal level shown on the VU meter. Short-term peak distortion may be hard to detect. Use discretion and experiment with the final meter level. For example, castanets should be recorded with no more than -20 indication

showing on the averaging VU meter. Even when the meter reads this low you can still get a good recording. Judge the recording by what you hear, the meters are only a guide.

The first two meters have dual labels, BUSS L/TRK 1 – BUSS R/TRK 2 which show that they serve two functions. When the light switch is depressed (battery operation) or when operating with the PS-P1 AC adaptor the meter light switching and RECORD FUNCTION LED will help you see at a glance what mode you are in.

METER LOGIC

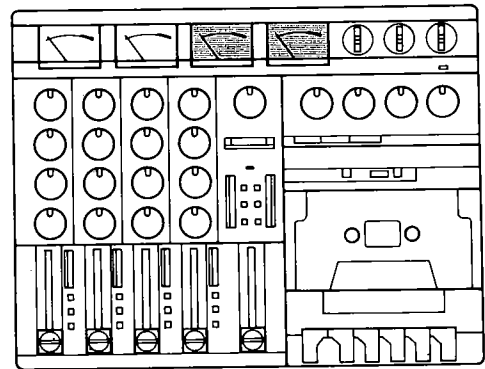
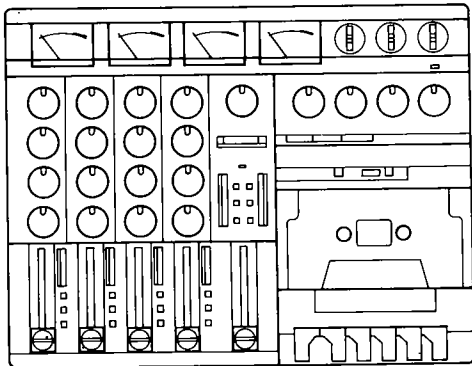
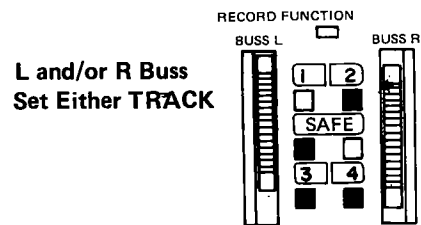
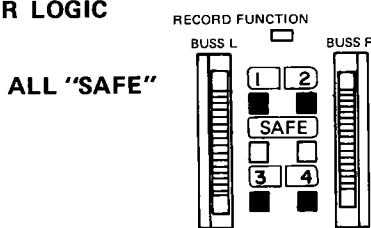

	RECORD FUNCTION LED	METER LIGHTS		
		BUSS L/TRK 1 BUSS R/TRK 2	TRK 3 TRK 4	
SAFE	OFF	ON	ON	Meter reflects input level of source selected on each channel
READY	Blink	ON	OFF	BUSS L/TRK 1 – BUSS R/TRK 2 meters show level of signals assigned to the L and/or R Buss. TRK 3 and TRK 4 meters show no signals.
RECORD	ON	ON	OFF	

CAUTION: The position of RECORD FUNCTION switches does not affect the monitor logic for the L/R Buss signals. If signal is present on a buss you will hear it in the headphones when you use REMIX or CUE. This can cause a problem when you are recording one track at a time, if you are "panned" to the wrong side (R Buss)

assigned, but you are panned to L Buss) you will "hear" the signal in the headset, but the recorder won't have anything to record. Always check the meter for the Buss you plan to record on for a good indication of level before "punching in" and you will avoid disappointment.

26 PITCH CONTROL

Sliding this control allows you to adjust the speed of the PORTA ONE by approximately $\pm 15\%$ in both record and playback modes. Sliding the knob to the left (-) slows the tape, while sliding it to the right (+) speeds up the tape. You can return to the basic speed of $1\frac{7}{8}$ ips (4.8 cm/sec) by setting it at the center detented position.

The PITCH CONTROL offers you a variety of creative possibilities. It may prove somewhat tricky to adjust because we wanted to give you the greatest possible range of speeds, and thus had to compromise on "fine tuning". For use with musical material this allows pitch changes of at least a 3rd to a 5th. Which provides a convenient way to add difficult vocal harmonies. In any case, we suggest that you use "full slow" or "full fast" only during final playback, as minor drifts in this control circuit from hour to hour may result in slight speed variations. If, for example, you use "maximum" during recording, you will not be able to make a minor "upward" correction during playback because you will have no leeway.

Also, it is recommended to make a run of several seconds in the play mode for the speed to stabilize, especially when the change in speed is large. Before beginning to record again, check the pitch carefully with a short playback, and you will have less trouble with drift.

CAUTION: dbx NR calibration will only be accurate at the basic speed of $1\frac{7}{8}$ ips (4.8 cm/sec). Recording at one speed and playing back at another may cause dbx decoding errors to have an effect on the dynamics of the signal. Since changing the speed of the tape will also alter the pitch (frequency) of recorded sounds, the use of this speed shift circuitry will be an artistic judgement we must leave to you.

27 DBX NR Switch

When playing a dbx-encoded tape or making a dbx NR recording, this switch must be depressed ().

28 TAPE OUT Jacks

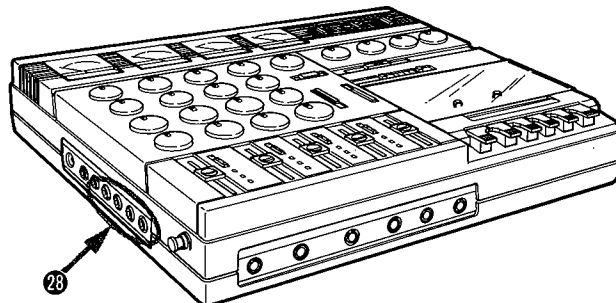

These RCA-type jacks provide output signals from each corresponding channel in playback. The TAPE CUE level control does not affect these jacks.

These jacks can be used to transfer, or "dub", your tapes onto another multi-track machine without remixing to a stereo format. This is desirable if you want to make a second generation copy of your original multi-track master. You can also dub the 4 tracks onto a larger format machine, such as an 8 track, then continue working with the 8 track to finish your project.

● LEVEL DIAGRAM

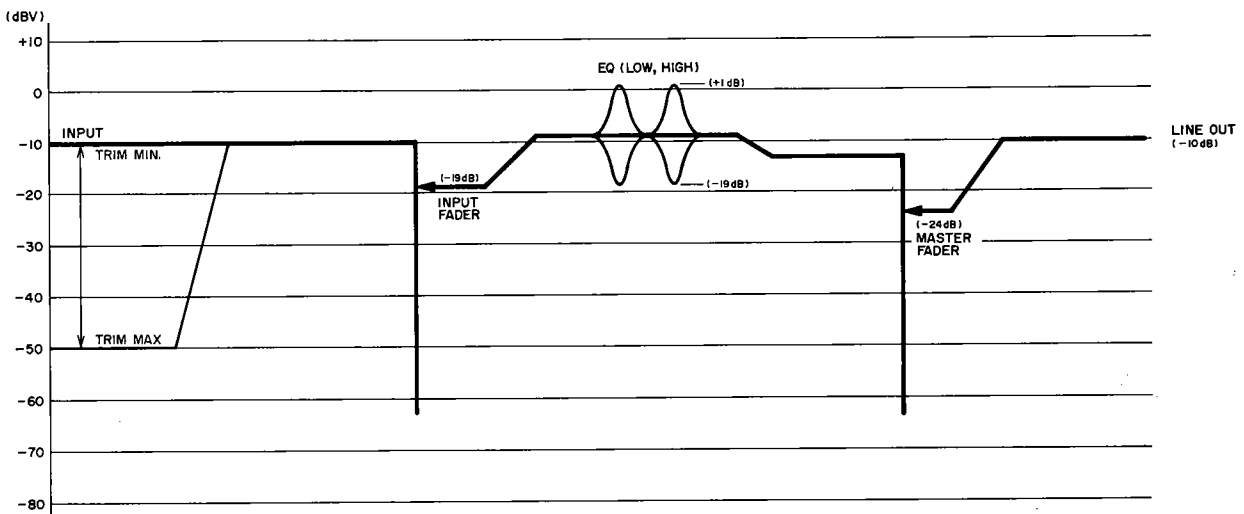
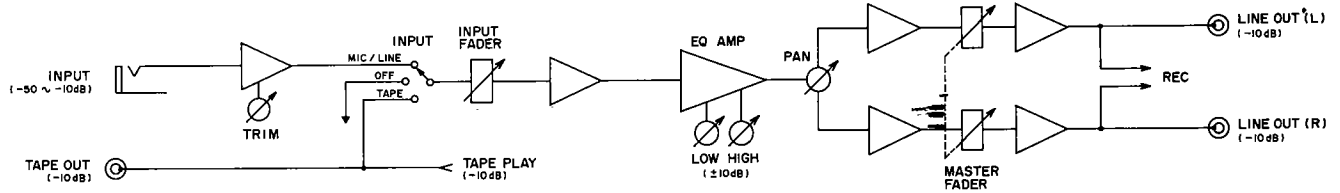
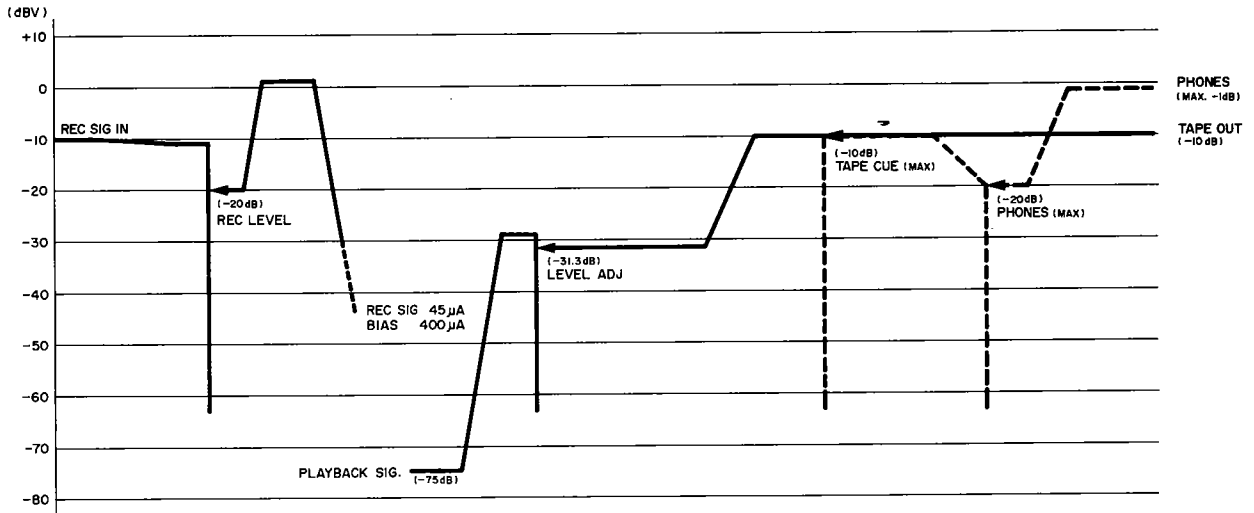
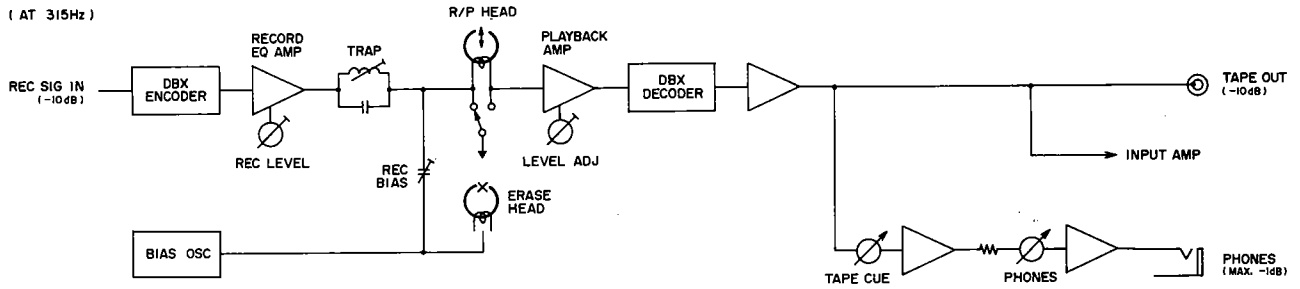

3. CIRCUIT DESCRIPTION

1 GENERAL

The PORTA ONE is basically a 4 channel mixer and a 4 track cassette recorder which are internally connected for easy convenient operations or editing works such as a ping-pong recording, over dubbing, etc.

Fig. 3-1 denotes the block diagram of the PORTA ONE showing overall schematic configuration.

To clearly understanding signal flowing routines in the circuit, major flowing routines are indicated on the following three cases:

a) When a signal "A" from a microphone is entered the INPUT

1 jack, and a signal "B" from a line is entered the INPUT 2 jack;

b) When playback signals "C" & "D" from the track 3 and track 4 of the tape deck are entered the channels 3 and 4 of the amplifiers, respectively; and

c) When the mixed results are recorded on the track 1 and track 2 of the tape deck.

4. Since both PAN controls for the channels 1 and 4 are set to the "R" channel side as can be seen from the block diagram, the signals A and D are mixed and entered the "R" channel LINE

OUT terminal. In this case, if there two PAN controls are set to the "L" channel side as the PAN controls for channels 2 and 3, all the signals A, B, C, and D are mixed and the resultant output will be led to L channel LINE OUT terminal.

Furthermore, if all the PAN controls are set to their center positions, all the signals A, B, C, and D are also mixed each other and the resultant outputs are equally distributed to both the left and right channel LINE OUT terminals.

5. The signal outputs mixed by the PAN controls and separated to the left and right channels of the LINE OUT terminals can be re-

corded on tape tracks designated by the FUNCTION switch (in this illustration, tape tracks 1 and 2).

6. These LINE OUT signals are also fed to the headphones amplifiers through the MONITOR switch and drive headphones.

7. For functions of the monitor switch and the meter switchings, refer to the "2. FEATURES AND CONTROLS" on page 4.

Note: The LINE OUT (L) will be recorded on either the tape track 1 or 3, and the LINE OUT (R) will be recorded on either the tape track 2 or 4, depending upon the setting positions of the REC FUNCTION switches.

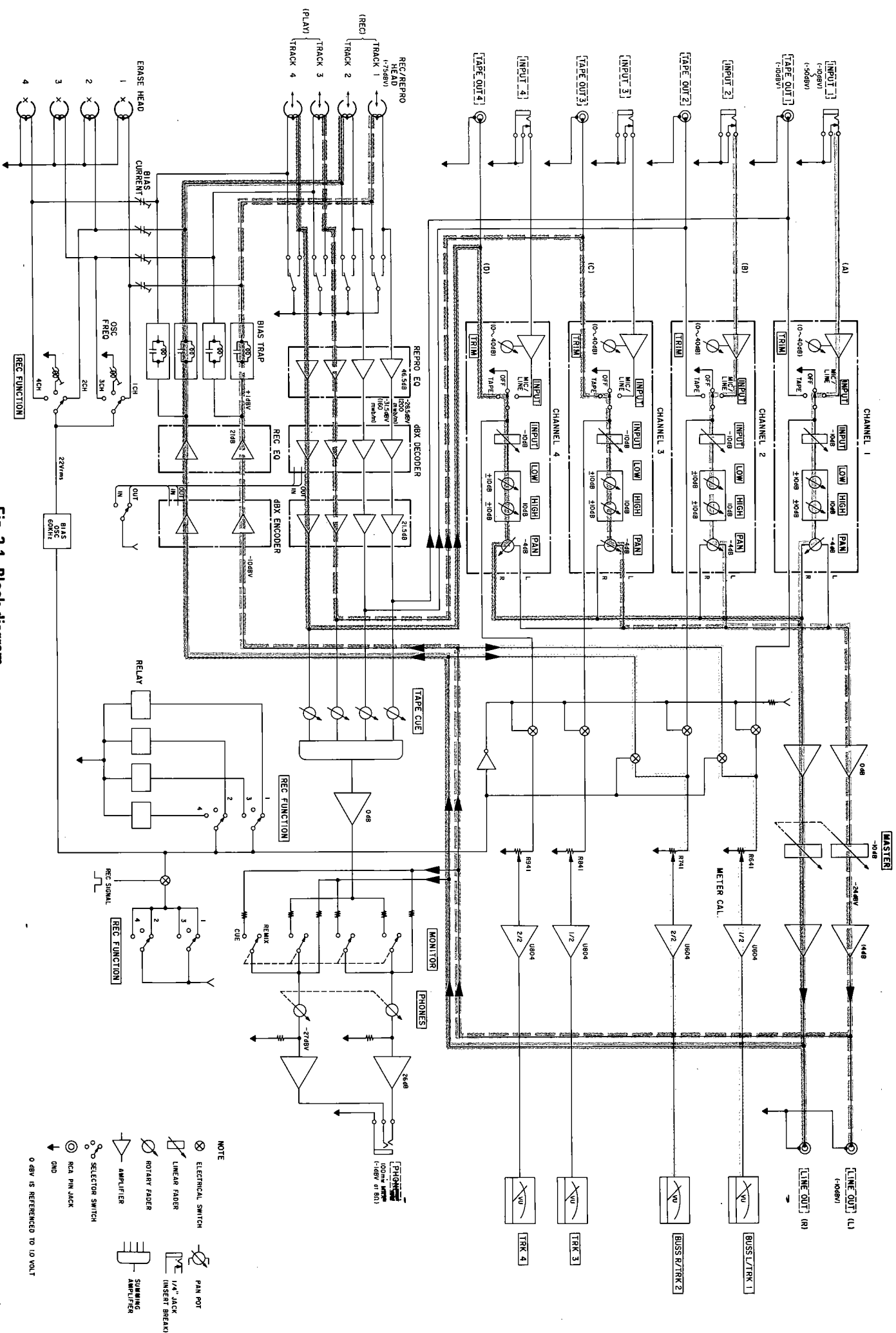

Fig. 3-1 Block diagram

CONTROL CIRCUIT

Fig. 3-2 shows the control logic circuit and Fig. 3-3 the motor control circuit.

Playback Operation

When the PLAY key is pushed, the PLAY SW in Fig. 3-2 is closed and pin 3 of P113 is grounded. As a result, the PLAY JTE signal line (D510 cathode side) goes "L", and the "L" level signal is used as a signal to release the PLAY MUTE operation.

With the PLAY key pushed, the MOTOR SW shown in Fig. 3-3 is closed, and a current flows from pin (1) of J1 into the motor passing through MOTOR SW, and Q1.

In this case, a time constant circuit consisting of R4 and C1 is used to prevent an excessive rush current from entering the motor immediately after the MOTOR SW closed by gradually increasing the base current of the transistor Q1.

Record Operation

The REC key can not be pushed as long as a cassette with its accidental erase protection tab not removed is loaded. When an arbitrary recording track(s) is set by the REC FUNCTION switch on the cassette loaded, the REC LED will blink.

When the REC key is pushed, the REC SW shown in Fig. 3-2 is closed and pins 6 and 7 of P113 are connected. As a result, the cathode side of D507 goes "H", and the output side of U504 goes "L".

When the REC SAFETY switch is closed if the accidental erase protection tab of the cassette is not removed.

When arbitrary recording tracks are designated by the REC FUNCTION SW, +9V is applied to pin 1 of P119 and the input side of U505 becomes "H" and the output side "L". Consequently, pin 9 of U502 goes "L" and pin 8 "H".

Since the output side of U504 is in "L", the input side pin 5 of U502 goes "L" and the pin 6 goes "H".

That is, the cathode sides of D506 and D506 change to "H" and the anode side of D507 "H", so pin 1 of U502 goes "H", pins 2 and 3 "L", and pin 4 goes "H". This "H" level signal is used as a record control signal.

With the REC key pushed, the MOTOR SW shown in Fig. 3-3 is closed and the motor rotates in the same way as in Play mode. Since pin 8 of U502 is "H" and pin 4 of U502 is "H", pin 4 of U502 develops "H" level signal and the "H" level signal is fed to the mixer amplifiers as the Record-ON signal.

Since pin 4 of U502 goes "H", the input side of U506 goes "H" and the output side "L", the REC LED is turned on.

Punch-in and Punch-out

When the power is turned on, +9V is applied to pin 5 of U502 through R529, so pin 6 of U502 goes "L" level. Then, pin 1 of U502 goes "L", pins 2, 3 "H" and pin 4 goes "L" level.

When the REC FUNCTION switch is closed in preceding the punch-in operation, +9V is applied to the input side of U505, and the output side of the same IC goes "L". The "L" level is transferred to pin 9 of U502 in passing through the RECSAFETY SW and makes pin 8 "H" level. Then, the REC LED starts to blink as previously mentioned in Record mode operation.

3. When the PLAY key is pushed, the PLAY SW is closed and a playback operation starts. In this case, pin 5 of U502 goes "L" and pin 6 "H". However, if the potential at pin 6 is changed from "H" to "L", the potential at pin 1 is not influenced because of the anode of D505 set to "L".
4. With a punch-in/punch-out adapter connected to the J501, and the adapter switch is pushed, both terminals of J501 are connected each other. Thus, the "H" level at pins 2 and 3 of U502 changes to "L" level, and this develops "H" level on pin 4. The "H" level signal actuates the bias oscillator, thus allowing record operation (punch-in) to start.
5. Next, when the adapter switch is pushed again, both terminals of J501 are shorted, and the "H" level potential at pin 1 of U502 is grounded through R525, thus lowered to "L" level again. As a result, pins 2 and 3 become "H" and pin 4 "L". Then the record bias is disabled and the operation mode is changed to the Play mode (punch-out).

3-2-4 Record Pause

1. When the PAUSE key is pushed under record condition, the PLAY SW shown in Fig. 3-2 is opened. However, the voltage level on pin 3 of P113 is not changed as the output side of U504 is maintained at "L" level.
2. On the other hand, when the PAUSE key is pushed during the Punch-in operation, the PLAY SW shown in Fig. 3-2 is also opened and pin 5 of U502 changes to "H" and pin 6 to "L". Then, pin 1 of U502 changes to "L", pins 2, 3 to "H", and pin 4 to "L", thus the recording condition is disabled. That is, a condition the same as the PLAY PAUSE will be created.

3-2-5 Zero-return

1. When the REW key is pushed with the zero return switch S1 turned on, the voltage on pin 1 of J1 is applied to the STOP SOLENOID in passing through the MOTOR SW, and R6//R7//R8//R9.
 2. When the counter is decremented and reaches "0000", the COUNTER SW closes and the STOP SOLENOID is actuated, thus stopping the rewind operation.
- Note: The MOTOR SW is designed to be closed when a key other than the STOP and the PAUSE key is pushed.

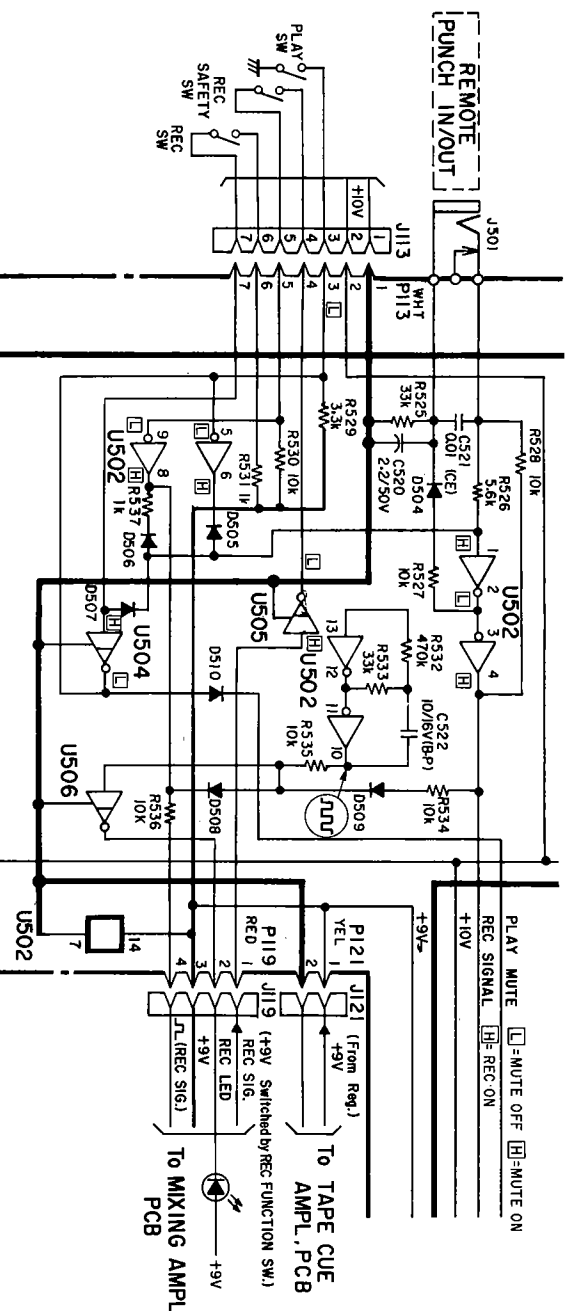

Fig. 3-2 Control logic circuit

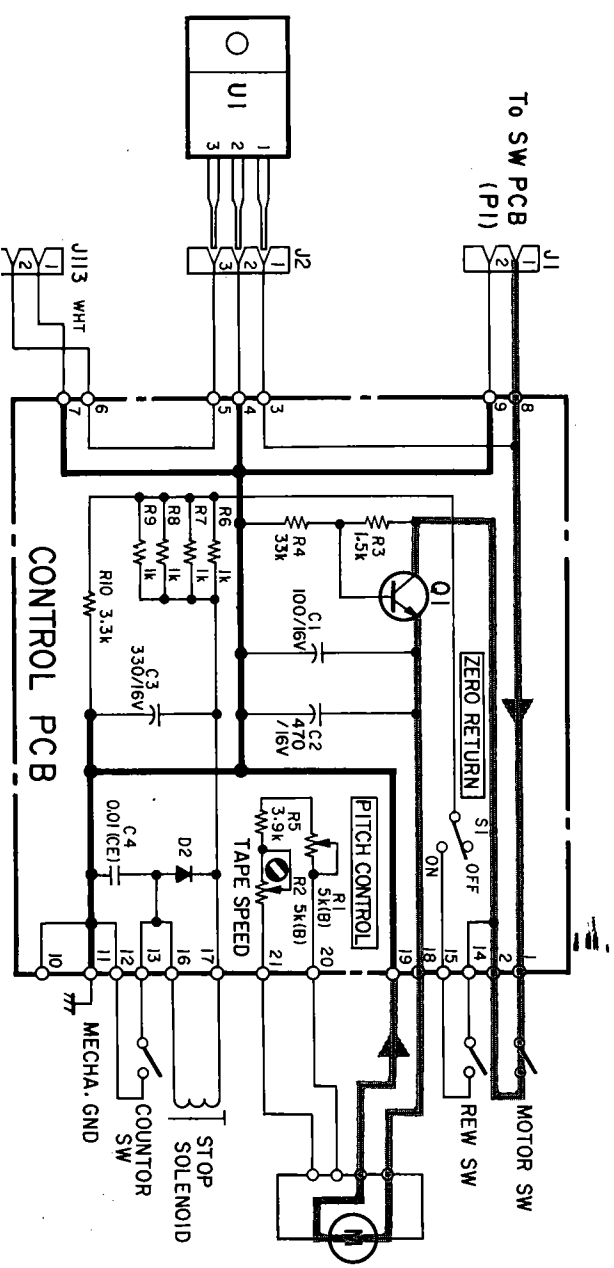

Fig. 3-3 Motor control circuit

3-3 POWER SUPPLY CIRCUIT (POWER MUTE CIRCUIT)

Fig. 3-4 shows a part of the power supply circuit.

1. A charging current flows into the base-emitter circuit of Q502 simultaneously with the rise of the voltage on the +10V line when the power switch turned on. That is, the Q502 becomes conductive and the collector develops the line voltage.
2. When the charging voltage across C513 increases after a short

time and reaches near the emitter voltage, the base current ceases and Q502 is cut off.

3. Thus created an impulse voltage is applied to the bases of switching transistors (as described later) and shorts out signal circuits for a short time, thus suppressing noises caused by turning on the power switch.
4. While, the +10V line voltage lowers when the power switch is turned off. At the same time, the electric charges stored in C513

are also discharged through a diode D502, so, the voltage at Q502 base is also dropped with the power turned off.

5. While electric charges stored in the capacitor C514 provided on emitter side of Q502 are interrupted by the diode D503 and prevented from immediate discharging. As a result, the emitter of Q502 is maintained at the positive potential (relative to the base potential) for a short time. That is, the Q502 is turned on and the charged voltage across C514 is developed on the collector of

Q502.

6. Thus created positive impulse on the Q502 collector is also used as the power-off mute signal. That is, the signal is applied to bases of switching transistors to prevent the switching noises in the same way as the power on switching.

3-4 MIXER CIRCUIT

Fig. 3-5 shows the

1. A microphone or firing through the output parts; the mixer arrangement.
2. The mixing operation.
3. The mixing operation.

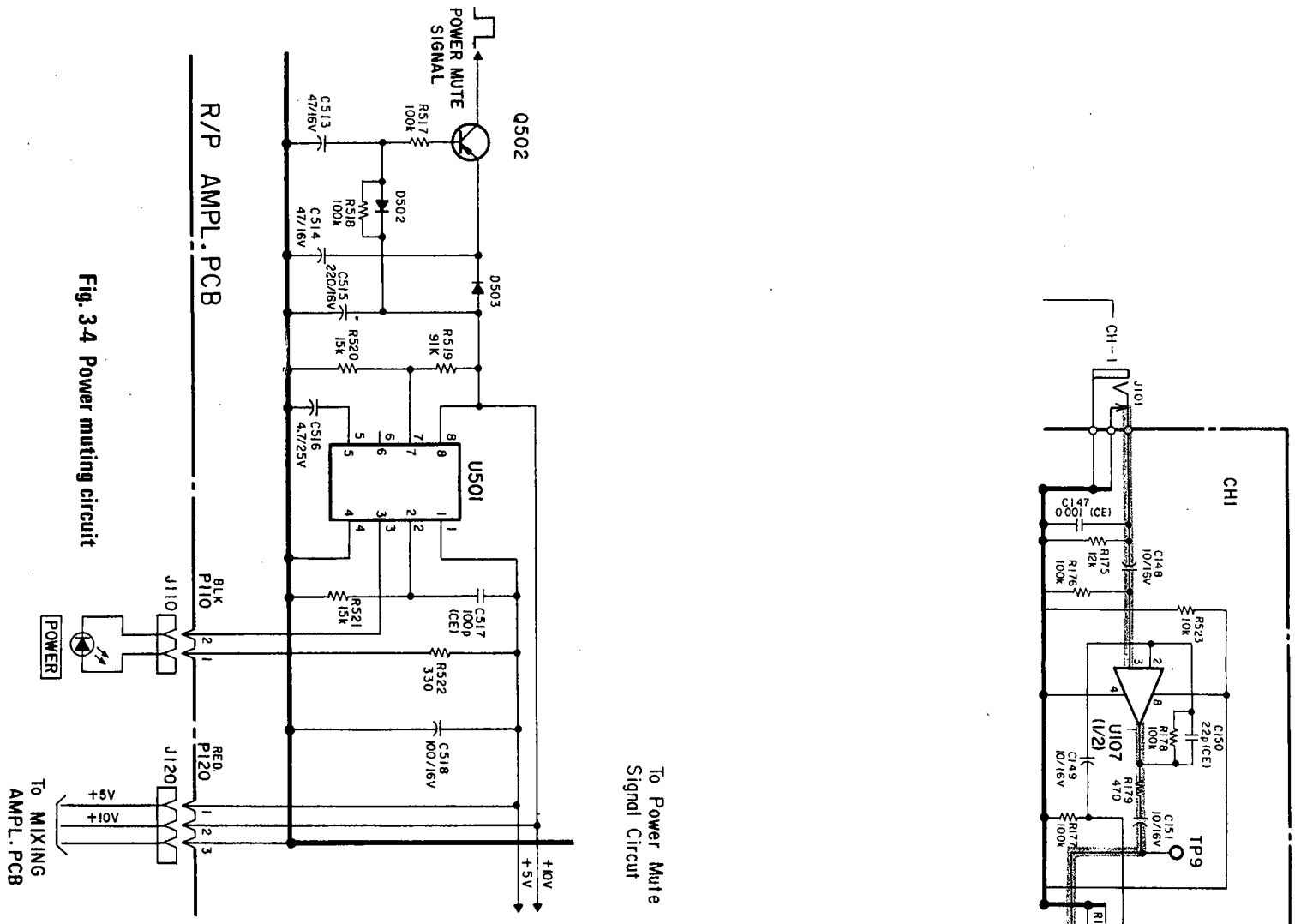

Fig. 3-4 Power muting circuit

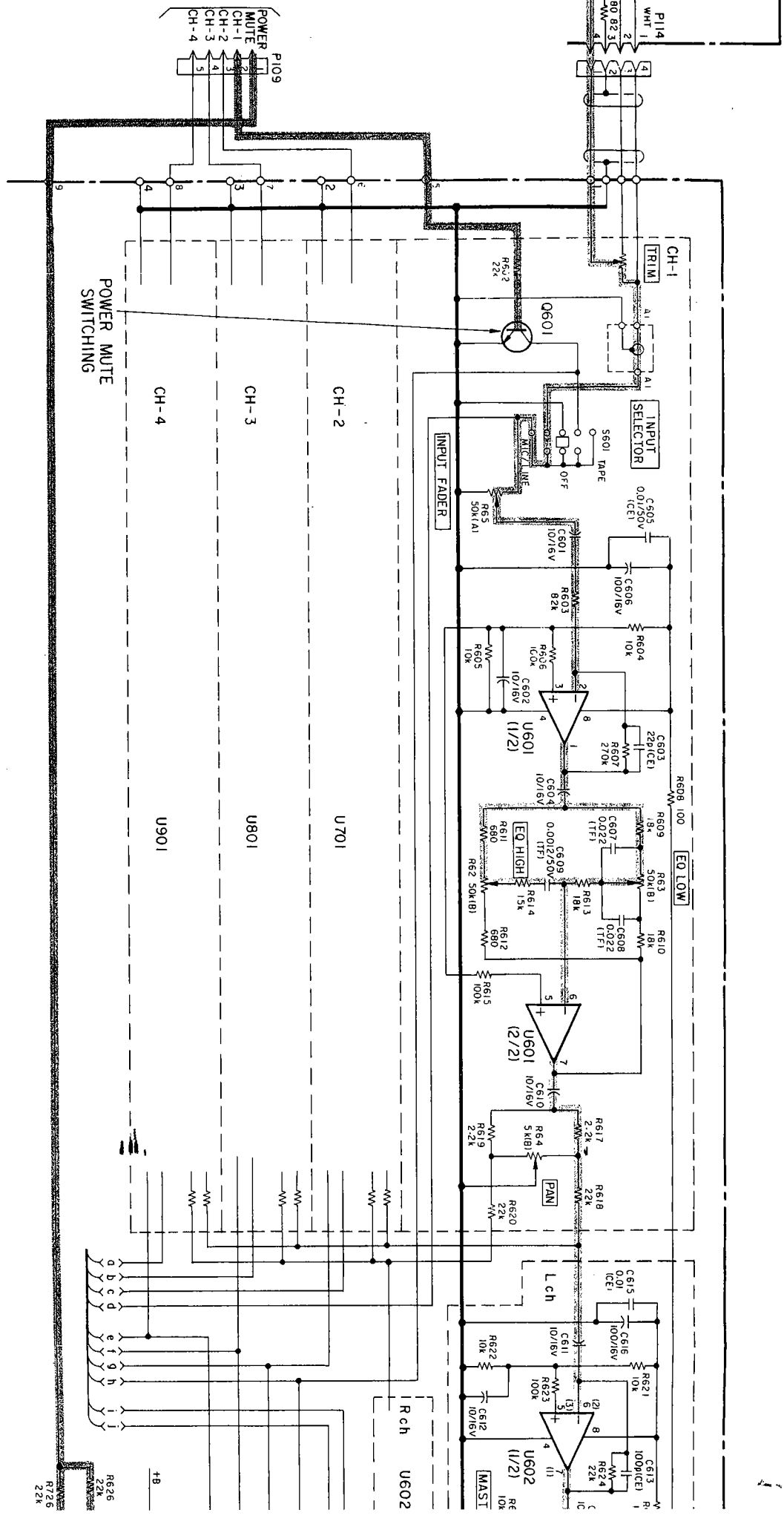

Fig. 3-5 Mixer amplifier circuit

stage, the base current ceases
applied to the bases of switch-
and shorts out signal circuits
noises caused by turning on
When the power switch is
electric charges stored in C513

are also discharged through a diode D502, so, the voltage at
Q502 base is also dropped with the power turned off.
5. While electric charges stored in the capacitor C514, provided on
emitter side of Q502 are interrupted by the diode D503 and pre-
vented from immediate discharging. As a result, the emitter of
Q502 is maintained at the positive potential (relative to the base
potential) for a short time. That is, the Q502 is turned on and
the charged voltage across C514 is developed on the collector of

Q502.
6. Thus created positive impulse on the Q502 collector is also used
as the power-off mute signal.
That is, the signal is applied to bases of switching transistors to
prevent the switching noises in the same way as the power on
switching.

3.4 MIXER CIRCUIT

1. Fig. 3-5 shows the mixing amplifier circuits.
2. A microphone or line signal applied to J101 is amplified in pas-
ing through the routines as illustrated and then split into two
parts: the mixer amplifier output and the headphone amplifier
input.
3. The mixing operation is determined by a position of the PAN
volume control of R64.

4. Q602 (Q702) is a switching transistor for the power muting.
Since the POWER MUTE signal as mentioned previously is con-
nected to the base of Q602, the audio signal circuit is grounded
during the power-on or off operation, thus preventing the
switching noises from entering the audio signal circuit.
5. As the base of Q601 is also connected to the POWER MUTE
signal line through D103, the Q602 also functions in the similar
way.

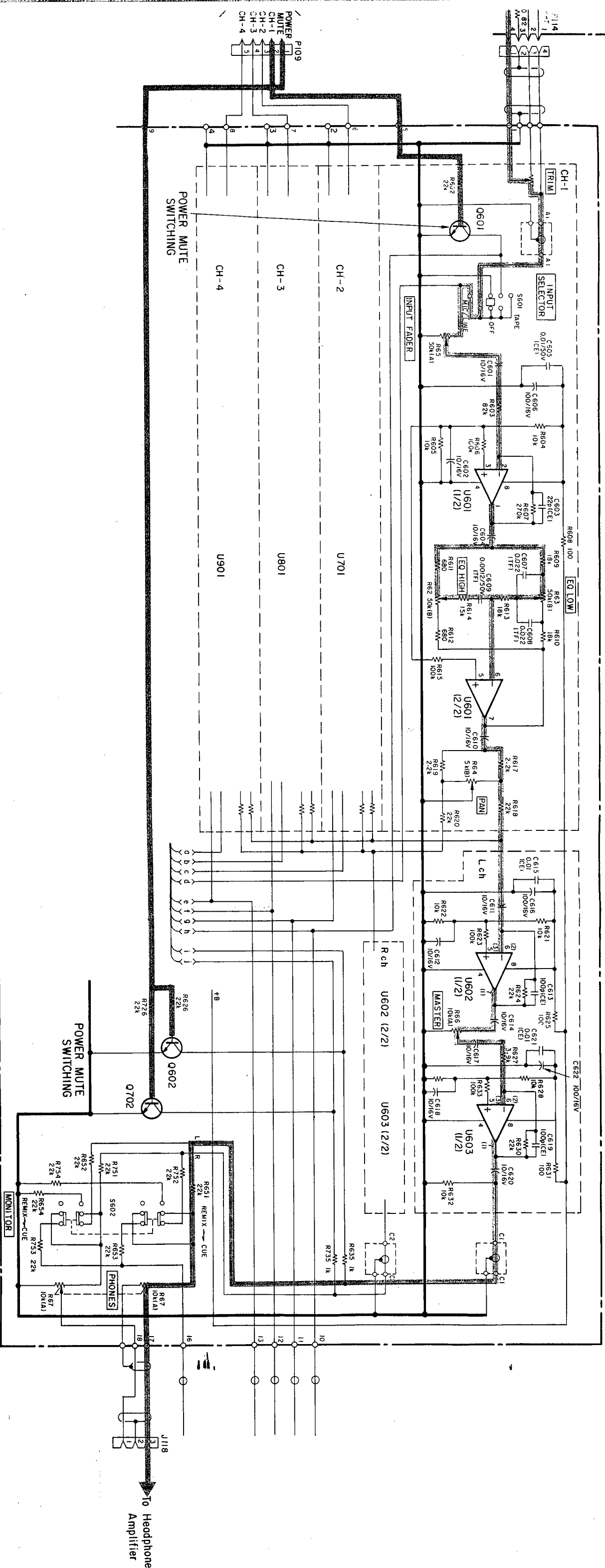

Fig. 3-5 Mixer amplifier circuit

3-5 RECORD AND PLAYBACK CIRCUIT

3-5-1 Playback Circuit

1. Fig. 3-6 indicates the record and playback circuits.
2. The playback signal induced on the head is amplified in passing through the routine illustrated on the diagram and used as the tape output.
3. Transistors Q103, Q104 work as the process control circuit for the dbx decoder.
4. A gate of Q105 is connected to the dbx switch through the terminal P108, and the dbx is disabled (OUT) with "H" level signal applied to the gate.
5. The base of Q101 is connected to the power mute output signal mentioned previously and functions as a switching transistor to eliminate undesirable noises caused by power on-off operations. The base of Q101 is also connected to the REC FUNCTION SW through D102, and set to the "H" level when the REC mode is set in the track belonging to the Q101, thus shorting the playback signal line to prevent undesirable influence between the playback and the record circuits.
6. The base of Q102 is connected to the PLAY MUTE signal mentioned in the "Control Circuit" and functions to reduce the signal level during the CUE/REVIEW mode.

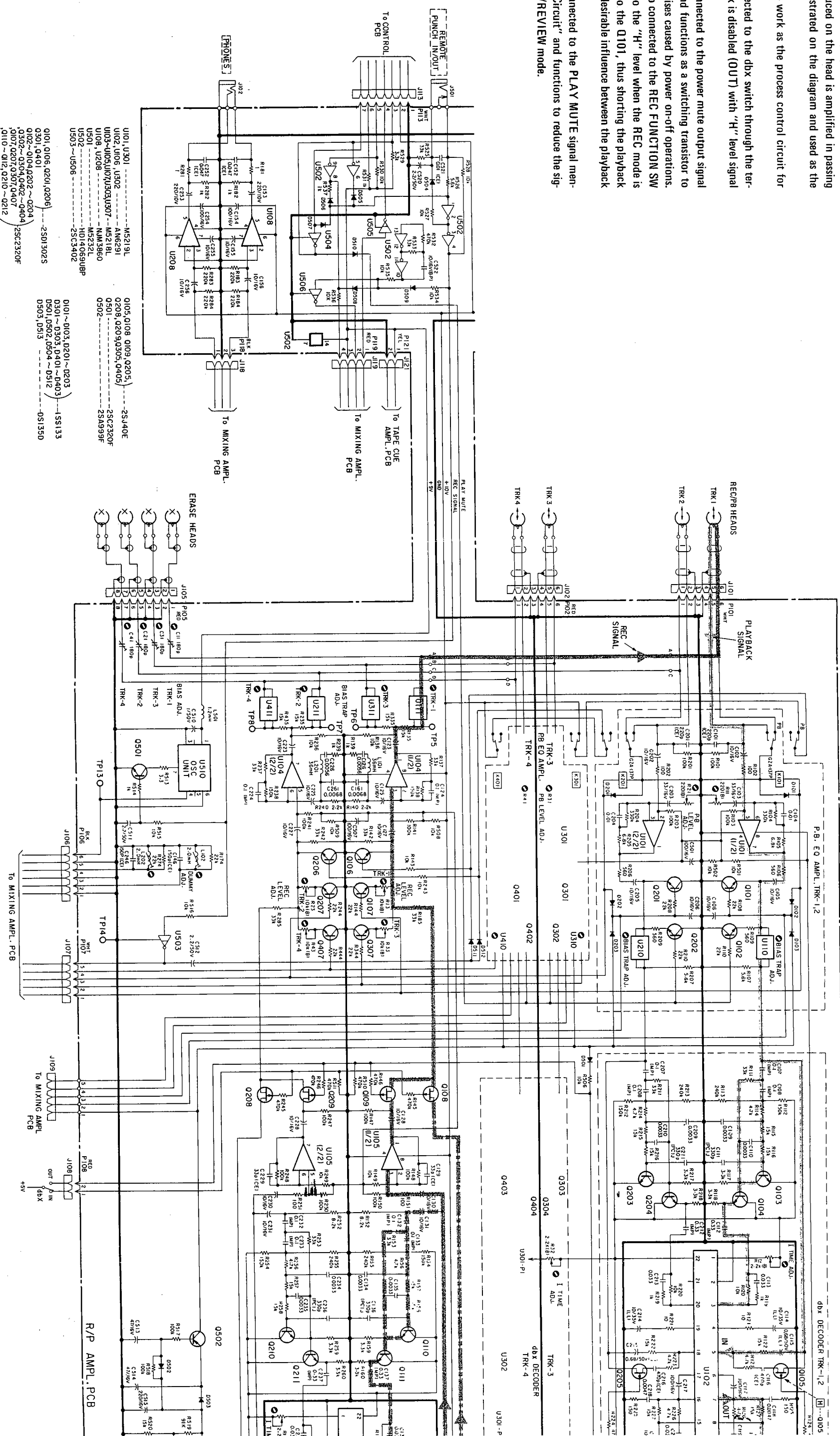

Fig. 3-6 Record & playback circuit

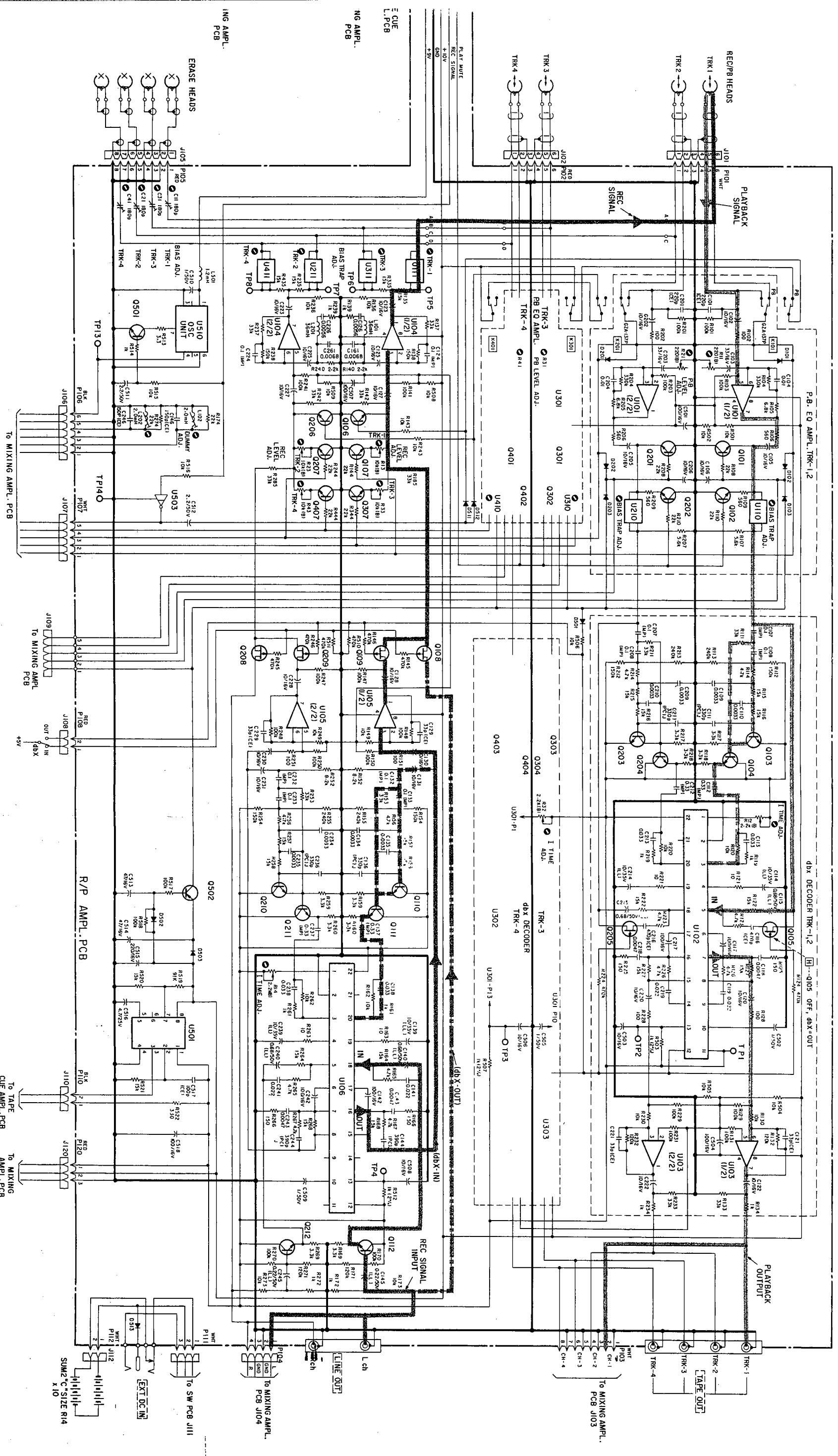
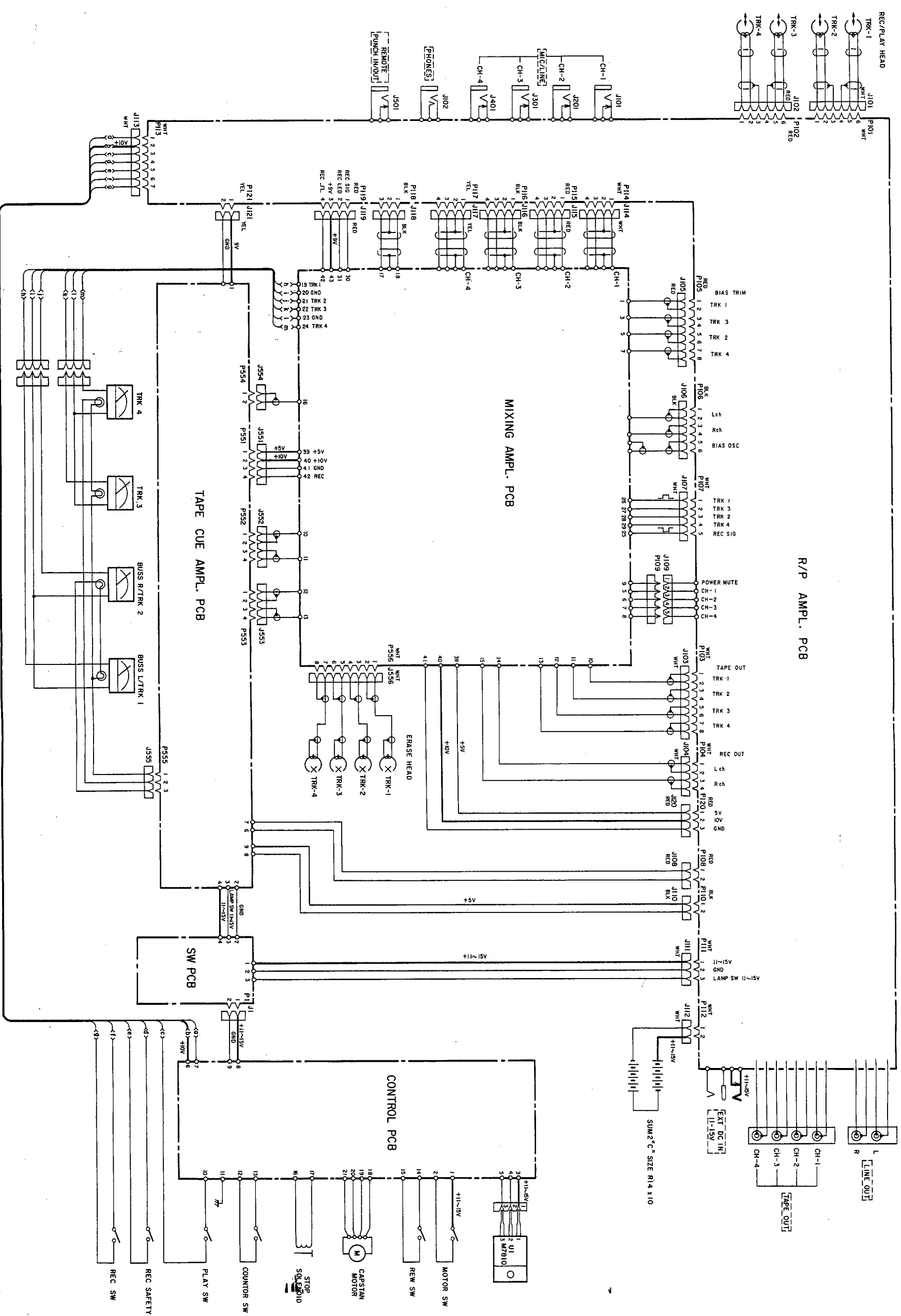

Fig. 3-6 Record & playback circuit



TASCAM PORTA ONE
 WIRING DIAGRAM
 TEAC Professional Division
 2nd Issue: December, 1984

MII
PO

BEFORE
 CURRENT
 PARTS

QUINT SERVICE CENTER
 2140 UNIVERSITY WAY
 SHERMAN OAK, CALIF. 91309

TASCAM
 TEAC Professional Division

SCHEMATIC DIAGRAMS

**MINISTUDIO
 PORTA ONE**

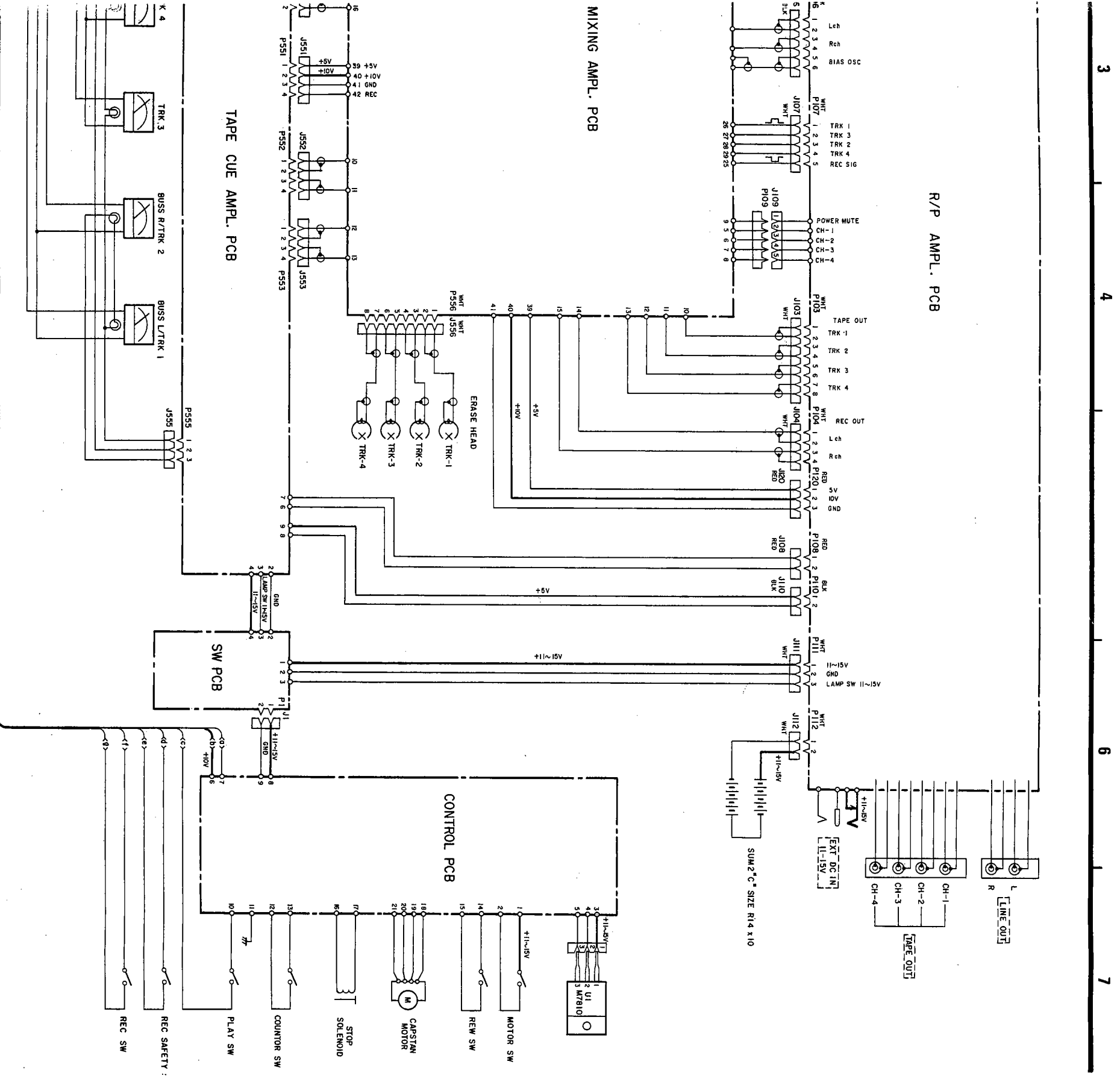

INSTRUCTIONS FOR SERVICE PERSONNEL
 BEFORE RETURNING APPLIANCE TO THE CUSTOMER, MAKE LEAKAGE-CURRENT OR RESISTANCE MEASUREMENTS TO DETERMINE THAT EXPOSED PARTS ARE ACCEPTABLY INSULATED FROM THE SUPPLY CIRCUIT.

- NOTES**
1. Resistor values are in ohms (k = kilo-ohms, M = meg-ohms).
 2. Capacitor values are in microfarads (p = picofarads).
 3. _____ : +B power supply circuit

TASCAM PORTA ONE
 TEAC Professional Division
 2nd Edition, December 1984

WIRING DIAGRAM

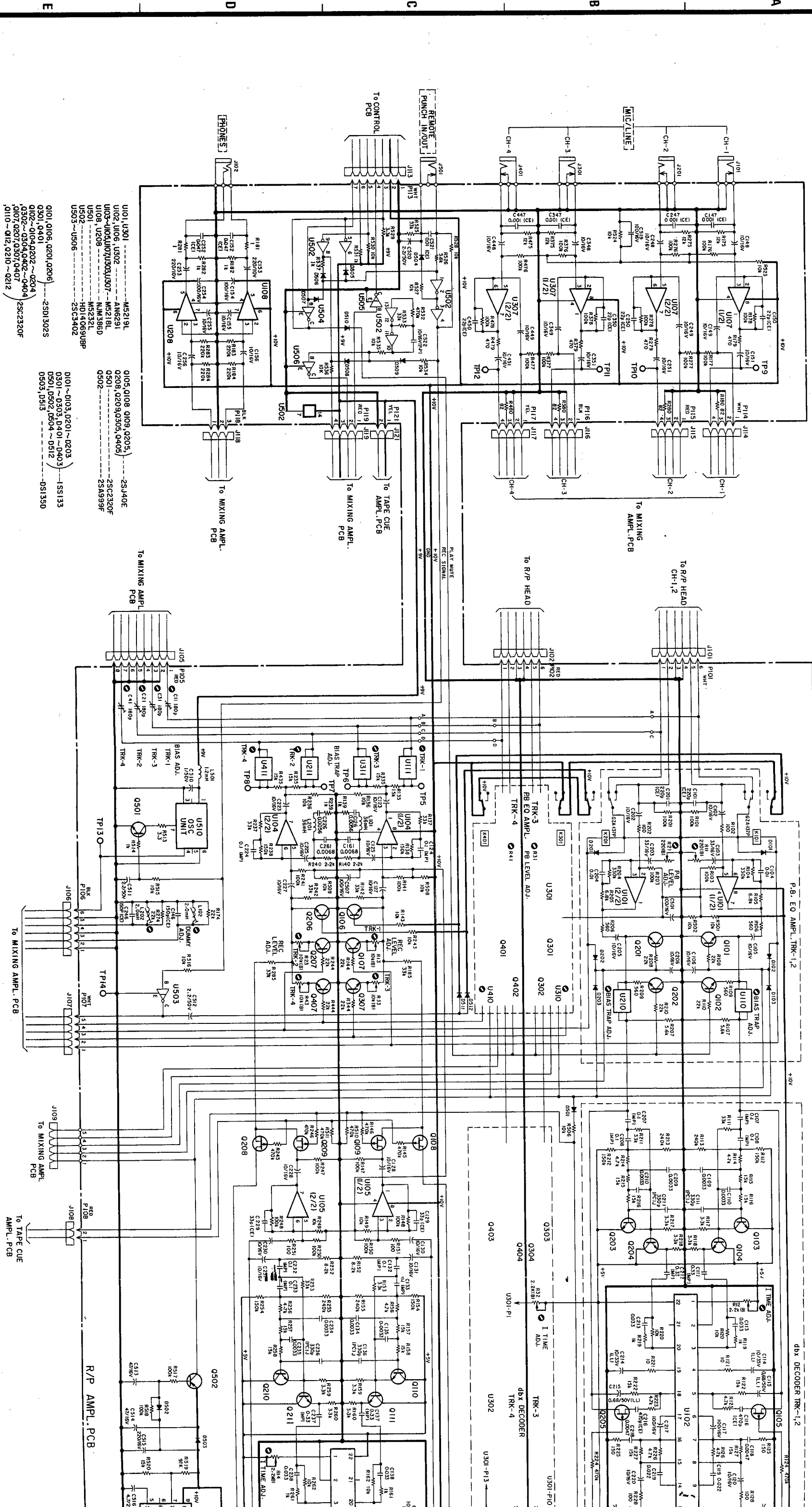

SOUND SERVICE CENTER
21826 SHERMAN WAY
CANOGA PARK, CALIF. 91301

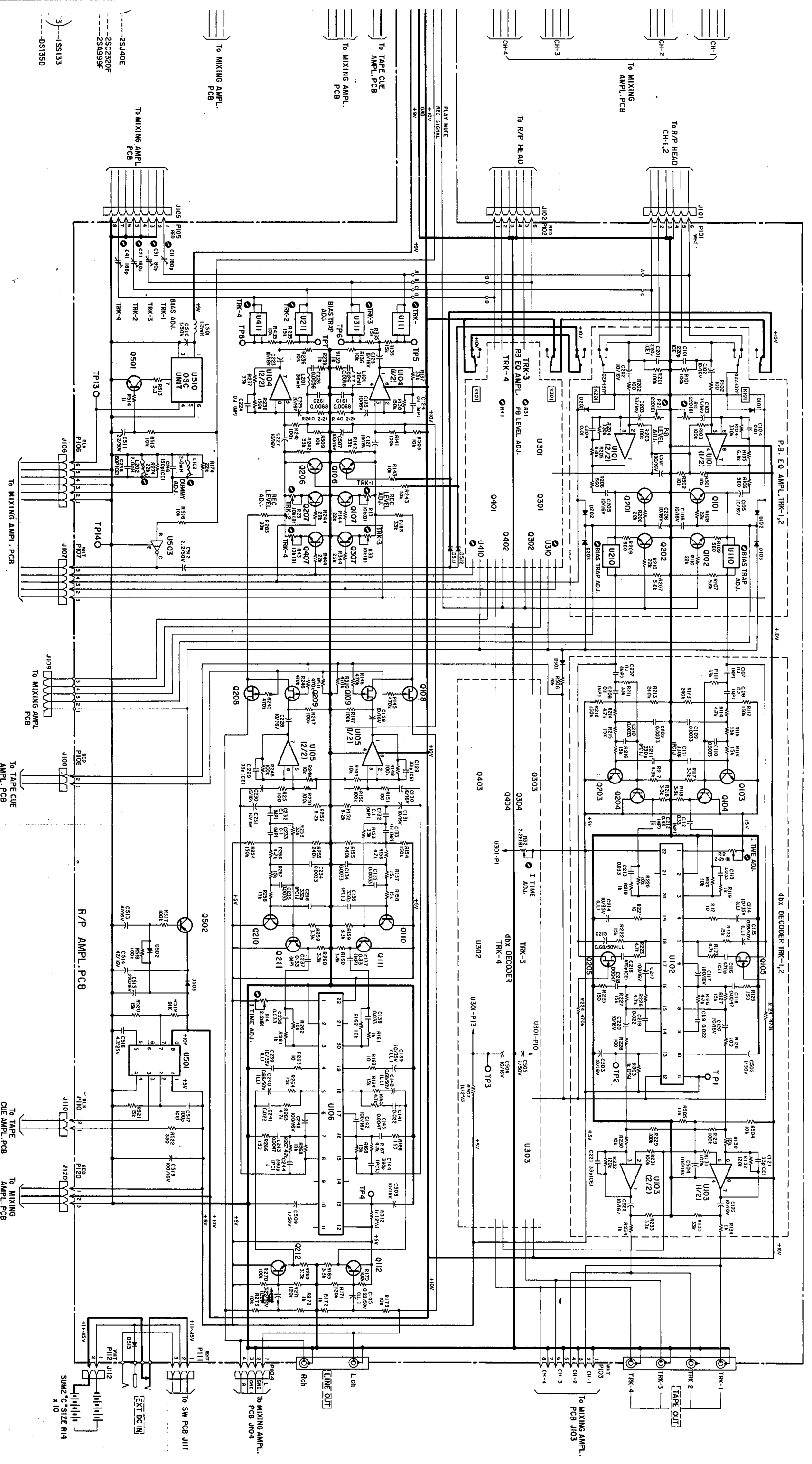

SOUND SERVICE CENTER
 21525 SHERMAN WAY
 CANOGA PARK, CALIF. 91304

RECORD/PLAYBACK AMPL PCB ASSY -
TASCAM PORTA ONE

3-5-2 Record Circuit

1. Record signals will flow as shown by the line — (dbx IN) and the - - - line (dbx OUT) in Fig. 3-6.
Transistors Q110 and Q111 function as the signal control circuit for the dbx encoder.
2. Each gate of Q108 and Q109 is connected to the terminals of the dbx IN-OUT switch through P108, and the Q109 turns off and Q108 ON when the dbx is OUT. While the dbx is IN, the Q108 turns off and Q109 on.
3. The record signal passed the Q108 or Q109, depending upon the position of the dbx switch, is amplified by U104 (1/2) and fed to the record head, thus recorded on a tape.
4. The transistor Q107 is a switching transistor for the record level adjustment circuit, and turned on when it is designated by the REC FUNCTION switch.
5. Q106 functions as a mute switch for record signals and turned on with "H" level signal from the REC/PLAY relay switch in the Playback mode, thus grounding the record signal circuit.
6. As previously mentioned under "Control Circuit", the REC SIGNAL line is "H" level in the record mode and the output side of U503 is set to "L" level. However, the output side changes to "H" level when the record mode is changed to the punch-out mode. The "H" level signal is applied to Q106 base through C512 and D511 to turn on the Q106 rapidly, thus preventing the recording from the switching noises which would be caused by the punch-in operation.
7. During recording, an "H" level signal is applied to the Q501 base and makes the Q501 turn on, thus actuating the bias oscillator.
8. The bias dummy circuits consisting of L102, L202, etc. are connected to the bias circuits for the tracks not designated by the REC FUNCTION switch to prevent undesirable fluctuations of the bias circuit due to possible load variations which would be caused if the dummies are not connected.

4. MAJOR PARTS LOCATION

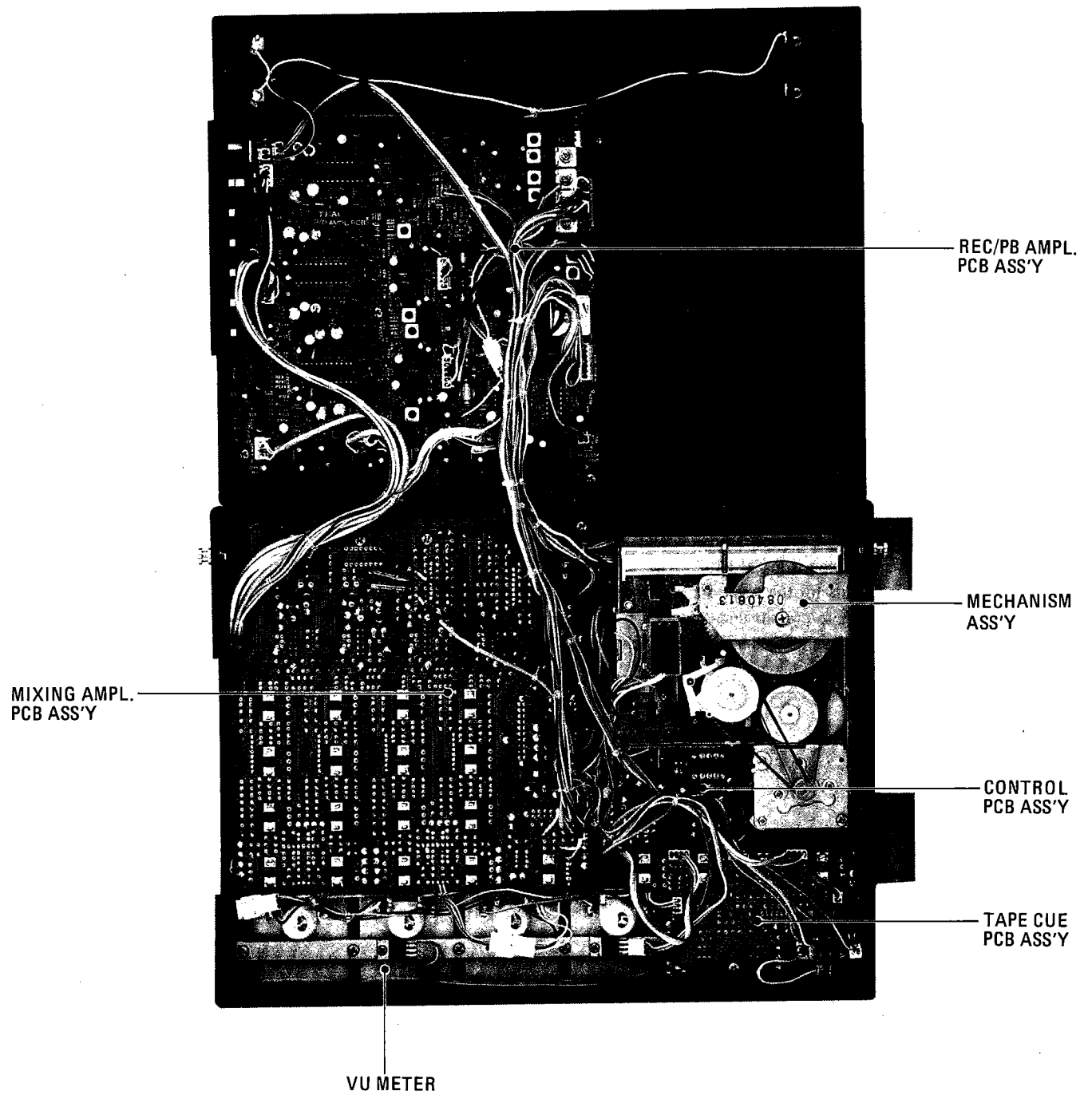

Fig. 4-1

5. MAIN MAINTENANCE EQUIPMENTS

Tools		Purpose
Cleaning Kit	TEAC TZ-261A chemical (head cleaner) or equivalent.	Cleaning for heads, tape guides, etc.
	TEAC TZ-261B chemical (rubber cleaner) or equivalent.	Cleaning for pinch roller.
Head eraser	TEAC E-3 or equivalent	Erasing heads & tape guides
Driver	Non inductive material (plastic, wood)	Bias tuning
Spring scale	0 ~ 500g	Pinch roller pressure adjustment
Torque meter	Cassette torque meter 0 ~ 100g-cm (Sony TW211) 0 ~ 160g-cm (Sony TW2231)	Reel torque measurement
Wow-flutter meter	For general use Range: 0.03% ~ Sensitivity: Higher than 10mV Characteristic: JIS, NAB, DIN/CCIR WTD/UNWTD	Wow-flutter measurement
Frequency counter	For general use Sensitivity: Higher than 25mV Impedance: Higher than 1M Ω Measurement frequency: 1 Hz ~ 10 MHz	Tape speed measurement Wow-flutter measurement Bias oscillator frequency measurement
DC voltmeter	For general use Digital or analog type Sensitivity: Higher than 0.1V	Voltage measurements for dbx amplifiers, others
AC level meter	For general use Range: -80 dB ~ +40 dB Impedance: Higher than 1M Ω , Less than 25pF Frequency bandwidth: Higher than 30kHz	Signal level measurement Bias alignment
Audio oscillator	Frequency: 10 Hz ~ 1 MHz Output level: Higher than 3V/600 Ω (variable) Distortion: Less than 0.1%	Input sensitivity
Attenuator	For general use Attenuation: Higher than 100 dB Step: 0.1 dB Impedance: 600 Ω	Input signal level setting
Oscilloscope	For general use Sensitivity: Higher than 20mV/DIV Sweep time Higher than 1 μ sec/DIV	Head Azimuth alignment
Distortion meter	For general use Frequency: 400 Hz, 1 kHz Sensitivity: Higher than 10mV Measurement range: Higher than 0.1%	Output signal distortion measurement
Band pass filter	For general use Bandwidth: 1 kHz (\pm 10%) Higher than 30 dB/OCT Bandwidth: IHF-weighted	Erasing effect measurement Crosstalk measurement

	Tools	Purpose
Test Tapes	TEAC MTT-111 (4900010100)	Tape speed, and wow-flutter measurement
	TEAC MTT-150 (4900011100)	Level adjustment (Dolby B-Type)
	TEAC MTT-356 (4900051900)	DIN Ref. level 31.5 Hz ~ 14 kHz Head azimuth, frequency response
	TEAC MTT-5061 (4900015000)	Blank tape (chromium position)

6. MEASUREMENT CONDITIONS FOR MAINTENANCE

1. Power Supply Voltage

Powered from AC adaptor (PS-P1): within AC rating voltage
±5%.

Powered from batteries: DC 12V ~ 15V

2. Reference Voltage 0 dBV = 1.0V

Reference line input level: -10 dBV (at TRIM min.)

Reference output level: -10 dBV

Reference tape output level: -10 dBV

3. Unless otherwise noted, the output load should be 50k ohms.

4. The output impedance of the audio oscillator supplying a signal to the MIC/LINE jack(s) should be 600 ohms or less.

5. Before proceeding performance checks and alignments for playback and record operations, clean and erase the tape running paths.

7. REMOVAL OF MAJOR PARTS

Sometimes it is difficult to see how to disassemble the parts. The following explains how to remove the major parts.

7-1 BOTTOM COVER (CASE R)

Remove the six screws securing the bottom cover.

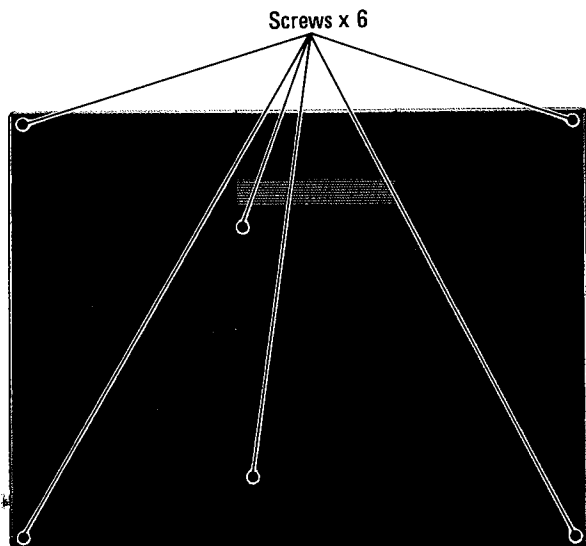

Fig. 7-1 Bottom cover

7-2 MECHANISM ASSEMBLY

Remove the bottom cover and pull off the five screws holding the mechanism assembly.

Capstan motor
speed adjust
trim pot R2

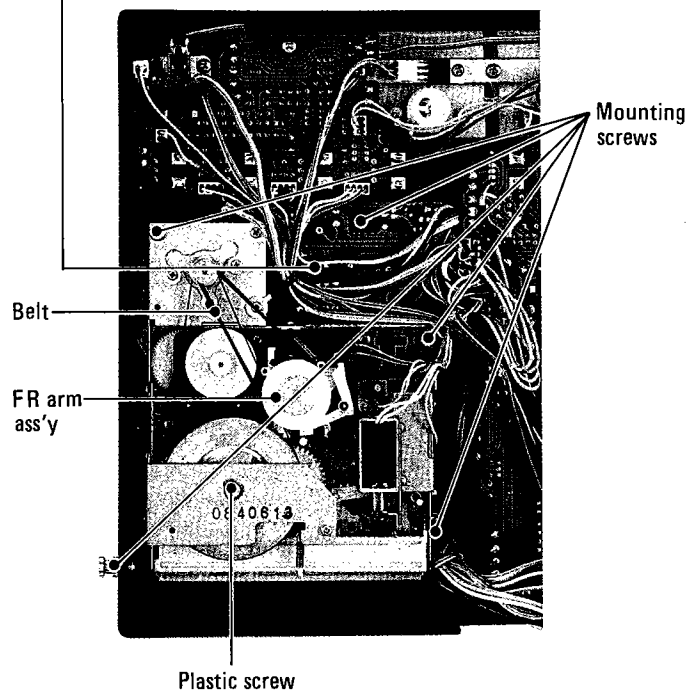

Fig. 7-2 Mechanism assembly

7-3 MIXING AMP. PCB ASS'Y, TAPE/CUE AMP. PCB ASS'Y

1. Remove all the knobs and fader knobs. Knobs can be removed easily using a pincette, etc.
2. Mixing Amp. PCB Ass'y can be removed by pulling out the five nuts (A) shown in the Fig. 7-3, and then the screws placed on the PCB side.

Tape Cue Amp. PCB Ass'y can be removed by pulling off the two nuts (B), as shown in Fig. 7-3.

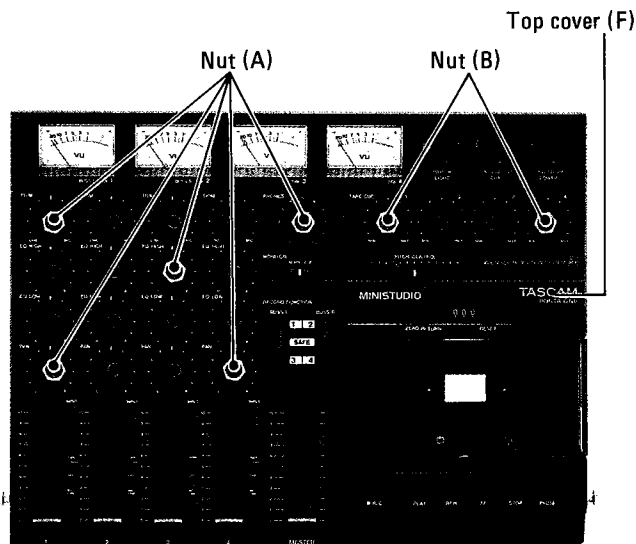
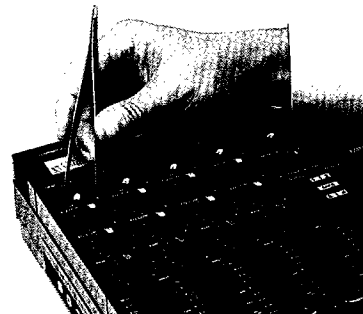

Fig. 7-3 PCB ass'y mounting nuts

7-4 PRECAUTIONS AND ITEMS CONFIRMED IN EXCHANGING THE HEAD AND MECHANISM ASS'Y

1. When remounting the REC/PLAY head, be sure not to tighten the head fixed screw (Fig. 8-4) too hard. Turn the screw by approx. 45° (with tightening torque of 2 kg-cm after the screw has started to work).
2. After replacing the head, place the mechanism Ass'y with a room so that the head wires as shown in the Fig. 7-4 are not stretched or not give any load when the head base moves.
3. When mounting the mechanism Ass'y, be sure not to tangle the dust sheet provided between PITCH CONTROL knob and mechanism Ass'y.

When mounting the mechanism Ass'y, place the PITCH CONTROL knob is its leftmost position and insert the knob through the slot of the dust sheet.

4. Confirm that each part of the mechanism Ass'y is placed in place in exchanging the mechanism Ass'y. (Refer to Fig. 7-4)

a. Recording Switch

There should be a clearance of 0 ~ 1mm between the record arm and the switch before loading a cassette half. The switch should be closed securely after loading the cassette half for recording.

b. Play Switch

The play switch should be "on" in the play mode and "off" in the pause mode.

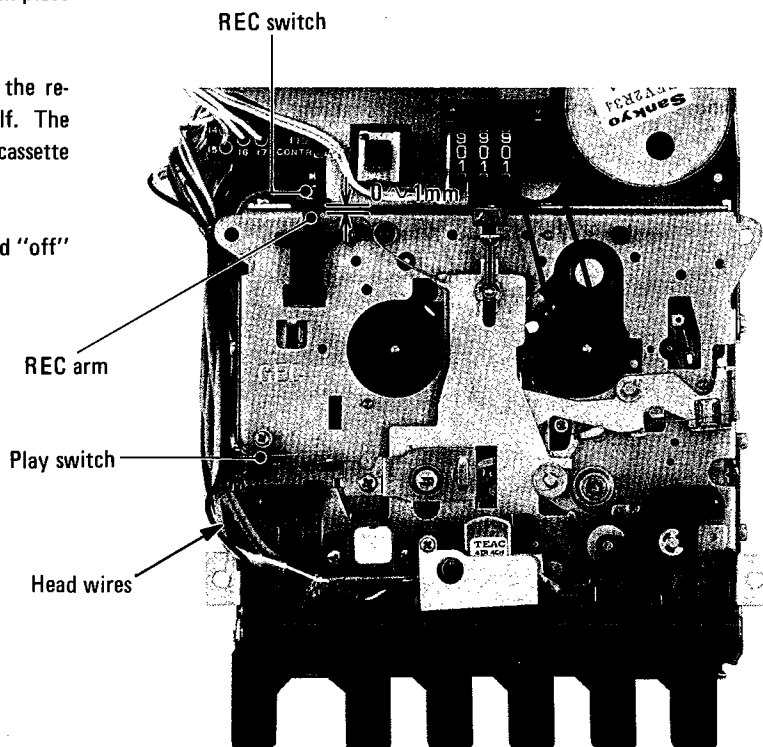

Fig. 7-4 REC switch and play switch

8. MECHANICAL CHECKS AND ADJUSTMENTS

8-1 CAPSTAN ASSEMBLY THRUST

Turn the thrust adjusting screw (plastic) provided on the bottom of the flywheel. Refer to Fig. 7-2.

Thrust of the capstan shaft is within 0.05mm ~ 0.3mm.

8-2 PINCH ROLLER PRESSURE

First remove the bottom cover and the top cover (F) as shown in section 7-1, 7-3.

1. Run the deck in PLAY mode and hook a tension gauge to a small opening on the pinch roller arm.
2. Pull the gauge slowly and read the gauge when the pinch roller just stops rotating. The reading should be between 300 and 500g.

8-3 TAKE-UP TORQUE

Take-Up Torque for Reproducing & Recording

1. Load a cassette torque meter instead of a cassette tape in the cassette holder, and run the deck in PLAY mode.
The meter reading should be:
35 to 70g-cm for Take-up torque (right reel table)
2 to 6g-cm for Back Tension torque (left reel table)
2. If the meter reading of the take-up torque is out of the limits, remove the poli-slider washer set on the top of the take-up reel table (right) shaft.
3. If the meter reading of the back tension torque is out of the limits, change the supplying reel table (left) and springs behind it.

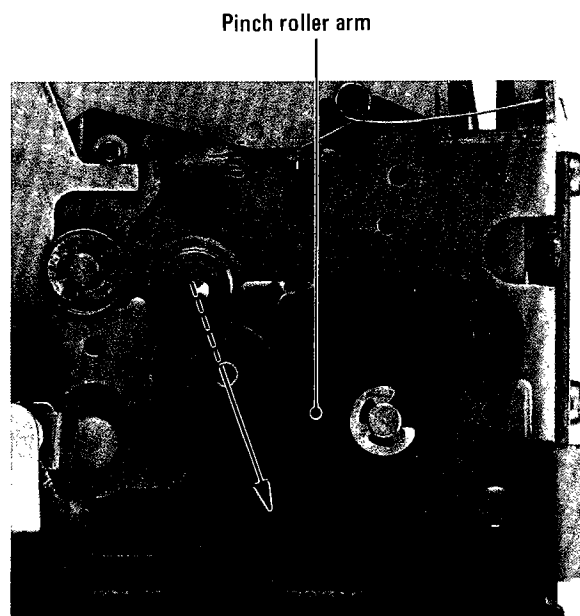

Fig. 8-1 Pinch roller pressure

FF and REW Torque

1. Load a cassette torque meter in the cassette holder and measure starting torque for both F.F and REW operations with the tape rewound close to beginning of the tape or wound close to end of the tape, respectively.

The reading should be:

F.F. torque (right reel table): 70 ~ 160g-cm.

REW torque (left reel table): 70 ~ 160g-cm.

2. If the torque is out of the limits, change FR Arm Ass'y and belt, if necessary. (Refer to Fig. 7-2)

8-4 TAPE TRAVEL

Using a mirror tape, check to see that the tape is running stably without curling and touching the tape guides on the erase and rec/play heads.

If there is curling of the tape affecting the response or damaging the tape, it is necessary to check the head guide height, perpendicularity of the head face, and alignment of the pinch roller in relation to the capstan. Mirror tape and Head Height Adjusting jig are required for checking.

To check the head guide height, the tape is replaced with the head height check jig, which is put on the base.

While firmly seating the jig on the surface of the base, slide the jig past each head guide to check if it goes through without hitting them.

Using the rear check bar of the jig, also check perpendicularity of each head face. If the guide is low, insert the required amount of 0.1mm or 0.2mm thick washers under the head mounting legs.

NOTE: Always adjust the head azimuth when the head height is adjusted.

8-5 HEAD AZIMUTH

Fine adjustment of the record/playback head should be made after the tape travel check has been completed. Before proceeding the adjustment, remove the head cover mounted on the Top cover (F). (Fig. 8-4)

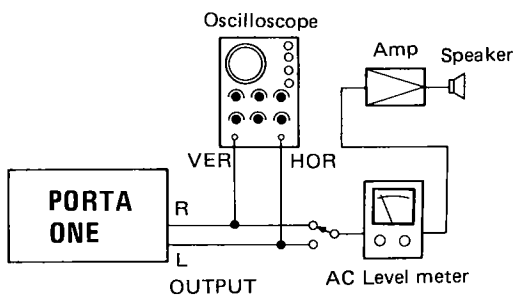

Fig. 8-2 Head azimuth measurement

1. Connect a vertical input terminal of an oscilloscope to the TAPE OUT "1" jack and a horizontal input terminal to the TAPE OUT "4" jack.
2. Load the deck with a test tape MTT-356 and playback the test signal.
3. First reproduce a test tone of 315 Hz, and coarsely adjust the azimuth adjusting screw to obtain approx. zero phase difference as shown in the Fig. 8-3. Next, reproduce a high frequency tone of 10 kHz and proceed to the fine adjustment.

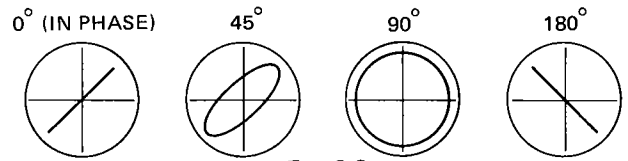

Fig. 8-3

4. Confirm that the output level of TAPE OUT 2 & 3 is not relatively low compared with that of TAPE OUT 1 & 4.

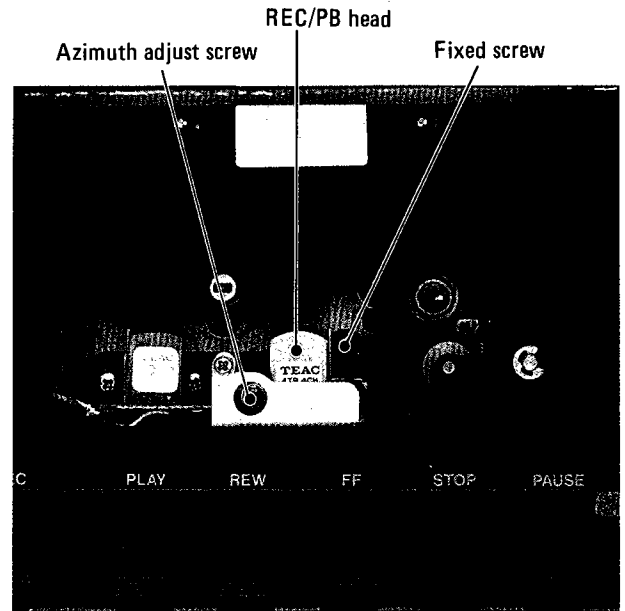

Fig. 8-4 Head azimuth alignment

8-6 TAPE SPEED

1. Connect a frequency counter to either one of TAPE OUT jacks.

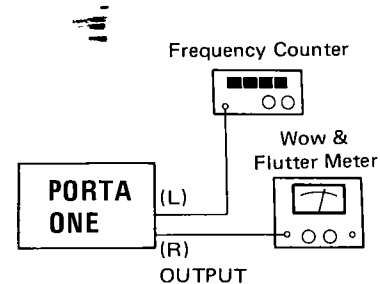

Fig. 8-5 Tape speed measurement

2. Playback a wow & flutter test tape and following values will be obtained.

Deviation: 3000 Hz \pm 45 Hz

Width of deviation: Within 30 Hz

Pitch control range*: Min. less than 2550 Hz at fully CCW Max. higher than 3450 Hz at fully CCW.

* Tape speed becomes minimum with the PITCH control knob turned up to the leftmost and maximum with the PITCH control knob turned up to the rightmost.

The test tape is the wow & flutter test tape MTT-111.

3. If the speed deviation is out of the limits, adjust as follows:
 - a. Remove the bottom cover as mentioned in section 7-1.
 - b. Clean the tape path and check the pinch roller pressure and take-up torque.
 - c. If they are normal, place the PITCH control in the center "click stop" position and reproduce approx. mid portion of the test tape.
 - d. Adjust the trim pot R2 (Refer to Fig. 7-2) provided on the control PCB with a small "—" driver to obtain 3000 Hz ± 5 Hz reading on the frequency counter.
The adjustment should be performed at least one minute after the capstan motor has been started to rotate.

8-7 WOW AND FLUTTER

Reproduce Method:

1. Connect a wow and flutter meter to one of TAPE OUT jacks.
2. Reproduce with a Wow and Flutter Test Tape MTT-111.
3. The measurement should be performed at both beginning and end of the tape.

Specification: 0.1% RMS (Weighted)

NOTE: Proceed to the measurement after cleaning the tape path, especially capstan shaft, pinch roller, and the head surfaces.

9. MIXER SECTION SIGNAL CHECKS AND ADJUSTMENTS

9-1 STANDARD SETTINGS OF CONTROL SWITCHES AND KNOBS

1. Before proceeding adjustments, set each control knob and switch as shown below:

Input fader	Maximum
MASTER fader	Scale position 7 ~ 8
INPUT selector switch	MIC/LINE
RECORD FUNCTION switch	SAFE
MONITOR switch	REMIX
PHONE knob	Min.
TAPE CUE	Min.
TRIM knob	LINE (fully counterclockwise)

- | | |
|-------------------------------|----------------------------|
| EQ HIGH, LOW knobs | Center (click position) |
| PAN channel 1, 3 | L (fully counterclockwise) |
| channel 2, 4 | R (clockwise) |
| DBX switch | Out |
| PITCH control fader | Center (click position) |
2. Apply -10 dBV (316mV), 1 kHz signal to the MIC/LINE jack.
 3. Adjust the TRIM knob for the channel 1 so that -10 dBV is obtained on the terminal TP9 of the REC/PB amplifier. (Refer to Page 32.) Generally, the TRIM knob may be placed in near fully counterclockwise position (minimum position).

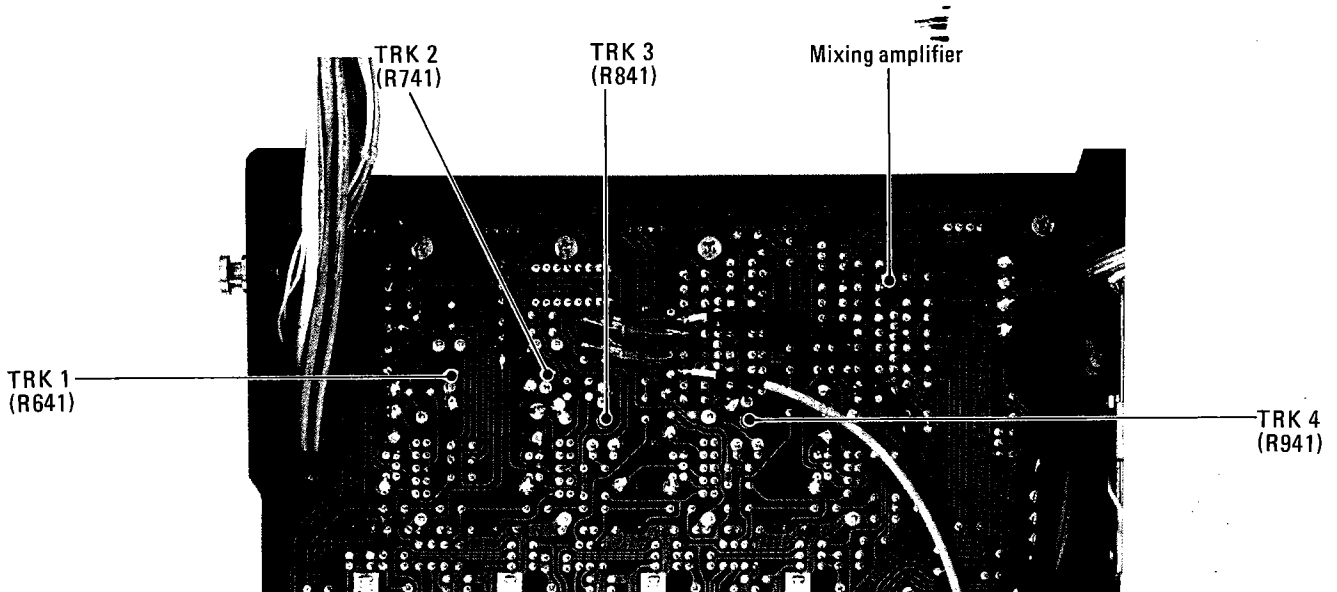

Fig. 9-1 VU meter level adjustment

- For the remaining channels also adjust the TRIM knobs to obtain the specified output in the similar way.

Channel 1: TP9
Channel 2: TP10
Channel 3: TP11
Channel 4: TP12

- * To determine positions of the TRIM knobs with the INPUT selector set to the MIC position, apply the test signal of -50 dBV (3.16mV) to the MIC/LINE jack, and adjust the TRIM knobs in the same way. Under this condition the TRIM knob will be located in a position close to maximum (fully clockwise).
- Adjust the MASTER fader until -2 dBV (794mV) is obtained on the LINE OUT (L) jack. Under this condition, the MASTER knob will be located at approx. "7 ~ 8" on the scale.
 - Adjust the input fader for the channel 1 to obtain -10 dBV is obtained on the LINE OUT (L) jack.
Reconnect the test signal to the MIC/LINE jack (3) and adjust the input fader for the channel 3 in the similar way.
 - Reconnect the test signal to the MIC/LINE jack (2) and adjust the input fader for the channel 2 until -10 dBV output is obtained on the LINE OUT (R) jack.
Apply the test signal to the MIC/LINE jack (4) and adjust the input fader for the channel 4 in the same way.

9-2 VU METER LEVEL ADJUSTMENT

Adjust following the trim pots (Fig. 9-1) so that each meter indicates "0VU" under the conditions with the TRIM knobs set as mentioned in the item 9-1. (Or test terminals TP9 - TP12 indicate -10 dBV.)

Adjustment: TRK1 (TP9): R641
TRK2 (TP10): R741
TRK3 (TP11): R841
TRK4 (TP12): R941

9-3 VU METER MONITOR IN RECORD MODE

- Load a blank cassette.
- Place the RECORD FUNCTION switch in the "1" position with the unit set to the condition with which the LINE OUT (L) jack develops -10 dBV as mentioned in the item 9-1, and make sure that the VU meter "BUSS L" indicates 0 ± 1 VU.
- In the same way, place the RECORD FUNCTION switch in the "2" position and make sure that the VU meter "BUSS R" reads 0 ± 1 VU under the -10 dBV developed on the LINE OUT (R) jack.

9-4 MIC/LINE V.S. LINE OUT FREQUENCY RESPONSE

Make sure that the frequency response for each channel is within the specified limit under the reference condition mentioned in the item 9-1.

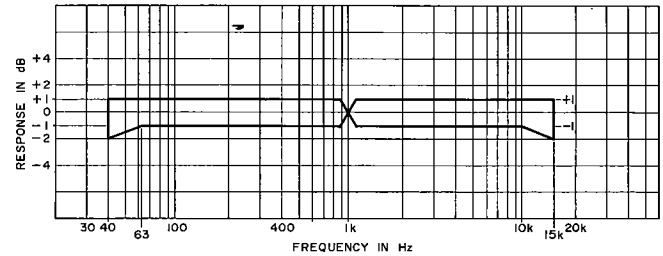

Fig. 9-3 MIC/LINE → Line out frequency response

9-5 EQUALIZER CHARACTERISTICS

- Rotate each EQ control knob with the unit set to the reference level mentioned in the item 9-1, and make sure that each LINE OUTPUT level changes as shown below as the frequency is varied:
EQ High Knob Max., Min.: ± 10 dB ± 2 at 10 kHz
Low Knob Max., Min.: ± 10 dB ± 2 at 100 Hz

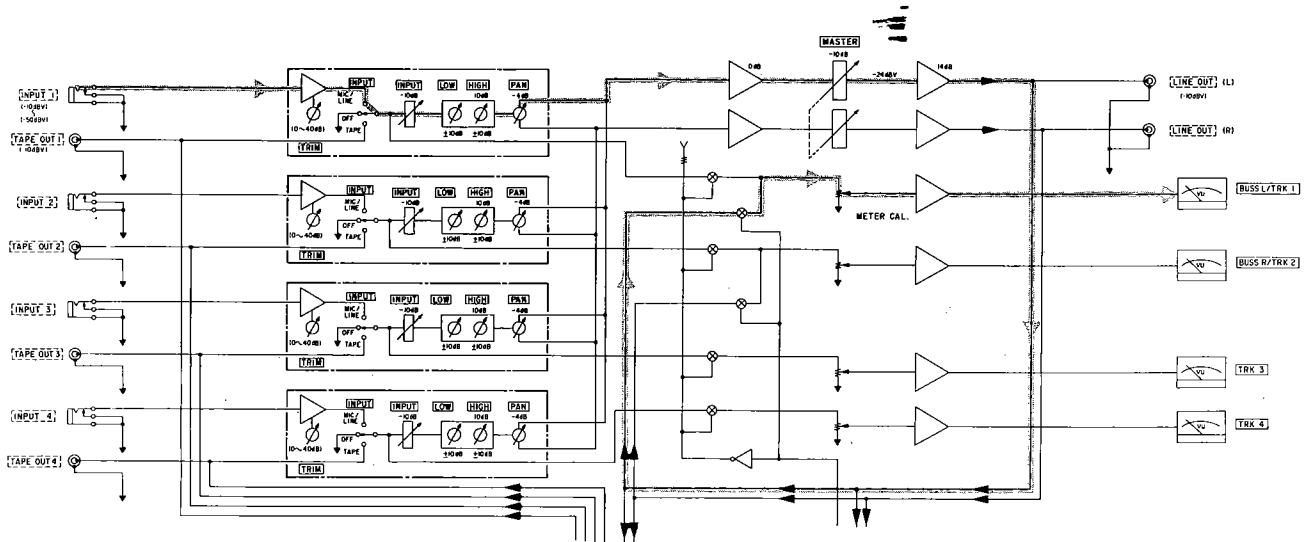

Fig. 9-2 VU meter monitor in record mode

10. RECORD/PLAYBACK AMPLIFIER CHARACTERISTICS

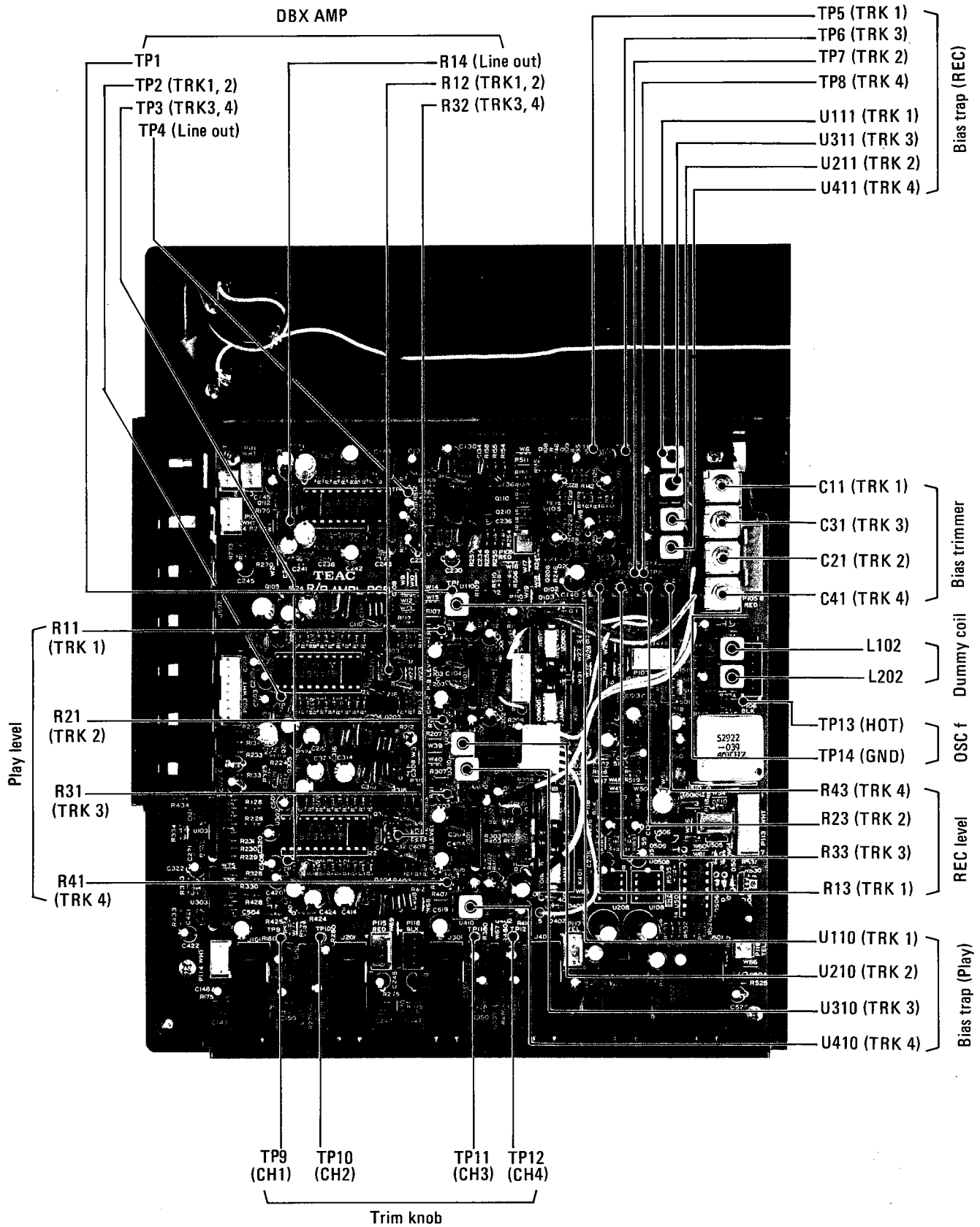

Fig. 10-1 Record/playback amplifier

10-1 PLAYBACK LEVEL

1. Connect a level meter to the TAPE OUT "1" jack on the side panel.
2. Playback a test tape MTT-150, 315 Hz, and adjust the trim pot R11 for -7 dBV (447mV) reading on the level meter. Under this condition, the VU meter will deflect 3 VU \pm 1 VU when the INPUT selector is switched in the TAPE side.
3. Connect the level meter to the remaining channel outputs (2, 3 4) and proceed to the adjustment in the same manner by adjusting.

VR21: for channel 2
VR31: for channel 3
VR41: for channel 4.

10-2 PLAYBACK FREQUENCY RESPONSE

1. Connect a level meter to the TAPE OUT "1" jack on the side panel.
2. Playback a test tape MTT-356 and reads the output level; it should be within the following limits.

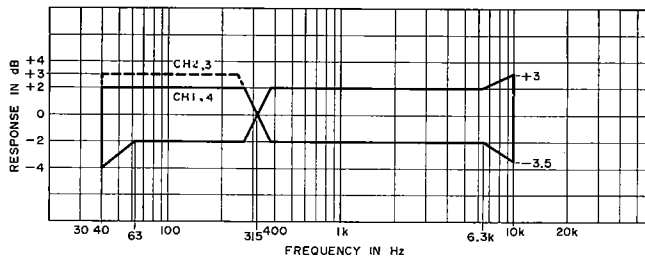

Fig. 10-2 Playback frequency response

3. If the output level is out of the limits, adjust the head azimuth and clean the head. (Refer to 8-5)
4. For the remaining channels (2, 3, 4), also check in the same manner.

10-3 DUMMY COILS

The dummy coils have been fixed in the factory and do not need readjustment except the following cases:

- a. When the erase head was replaced.
- b. When the REC/PB amplifier PCB assembly unit was replaced.

1. Connect the frequency counter between TP-13 (Hot) and TP-14 (GND) on the REC/PB amplifier PCB.
2. Load a blank tape MTT-5061 in the cassette deck and set it to the REC PAUSE mode.

Check the bias oscillator frequencies in the following combinations of the recording tracks:

- TRK1 and 2 set to record mode: $f_{1,2}$
- TRK1 and 4 set to record mode: $f_{1,4}$
- TRK3 and 2 set to record mode: $f_{3,2}$

3. Set the TRK1 to the record mode, and adjust L202 until the frequency f_1 is obtained.
$$f_1 = 1/2 (f_{1,2} + f_{1,4})$$
4. Set the TRK2 to the record mode, and adjust L102 until the frequency f_2 is obtained.
$$f_2 = 1/2 (f_{1,2} + f_{3,2})$$
5. Make sure that the variation of the oscillator frequency at each track in the record mode is within $f \pm 1$ kHz.

10-4 BIAS TRAP

The bias trap has been fixed at the factory and no adjustment is necessary except:

- a. the REC/PB head was replaced.
- b. the REC/PB amplifier PCB unit was replaced.
- c. Excessive bias leakage was observed.

● U110 (TRK1), U410 (TRK4) --- Playback Amplifier

- 1) Connect a level meter or an oscilloscope to the TAPE OUT "1" (and 4) jack on the side panel.
- 2) Load the tape deck with a blank tape (MTT-5061) and set the TRK2, 3 to the record pause mode.
- 3) Adjust the bias trap U110 (TRK1) for minimum bias leakage (minimum reading on the meter or minimum amplitude on scope display) from the adjacent channels.
- 4) Adjust U410 (TRK4) in the same way for minimum leakage, connecting the level meter or oscilloscope to the TAPE OUT "4" jack.

● U210 (TRK2), U310 (TRK3) --- Playback Amplifier

- 5) Connect the level meter or the oscilloscope to the TAPE OUT "2" (and 3) jack on the side panel.
- 6) Load the deck with a blank tape MTT-5061 and set the TRK1, 4 to the record/pause mode. Adjust the bias trap U210 (TRK2) for minimum bias leakage (minimum reading on the meter or minimum amplitude on the scope display) from the adjacent channels.
- 7) Adjust U310 (TRK3) in the same manner for minimum leakage, connecting the level meter or oscilloscope to the TAPE OUT "3" jack.

● U111 (TRK1), U211 (TRK2) --- Record Amplifier

- 1) Connect the oscilloscope between TP5 (TRK1), TP7 (TRK2) and TP14 (GND) on the REC/PB amplifier PCB.
- 2) Load the blank tape MTT-5061 in the deck and set the TRK1 and TRK2 to the REC PAUSE mode.
- 3) Adjust U111 (TRK1) and U211 (TRK2) for minimum bias leakage.

● U311 (TRK3), U411 (TRK4) --- Record Amplifier

- 4) Connect the oscilloscope between TP6 (TRK3), TP8 (TRK4) and TP14 (GND).
- 5) Set the TRK3 and TRK4 to the REC PAUSE mode.
- 6) Adjust U311 (TRK3) and U411 (TRK4) for minimum bias leakage.

10-5 BIAS VOLTAGE

The bias voltage is applied to a bias trimming capacitor for each track by selecting the RECORD FUNCTION switches properly and the bias voltage to be applied to the head can be varied to a considerable level by rotating the trimmer.

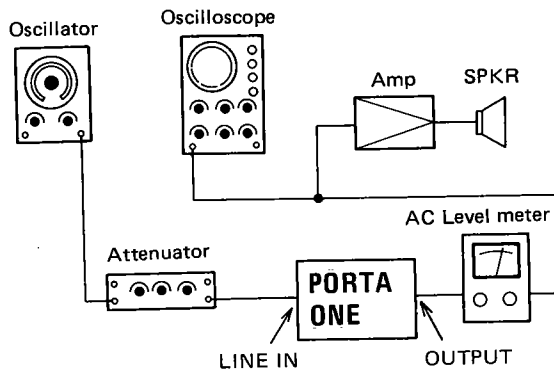

Fig. 10-3 Bias voltage measurement

1. Connect the test equipments as shown in Fig. 10-3. Connect an AF oscillator to the MIC/LINE "1" jack and a level meter to the TAPE OUT "1" jack. (Also connect a level meter to the LINE OUT "L" (R) jack as required.) Adjust each fader control until the LINE OUT level of -10 dBV is obtained as mentioned under the item 9-1. (Refer to 9-1).
2. Load a blank tape MTT-5061 in the deck.
3. Place the RECORD FUNCTION switch in the TRK "1" position to set the TRK "1" to the record mode. Under this condition, the VU meter will show 0VU. If the meter deflection error is observed, perform readjustment as shown in the item 9-2.
4. Reduce the input signal level by 20 dB from the reference level or to -30 dBV (31.6mV).
5. Alternately record a 400 Hz signal and a 10 kHz signal and then playback the signals. Adjust the bias adjustment trimming capacitor C11 (TRK1) so that both the playback outputs become equal.
6. Adjust for the remaining tracks in the same way.
 - TRK1: C11
 - TRK2: C21
 - TRK3: C31
 - TRK4: C41

10-6 RECORD LEVEL

1. Connect test equipments as shown in Fig. 10-3, and adjust each fader control on the front panel so that -10 dBV is obtained at the LINE OUT jack as mentioned in the item 9-1.
2. Load a blank tape MTT-5061 in the deck.
3. Set the TRK "1" to the record mode using the RECORD FUNCTION switch.
4. Record an input signal of -10 dBV. Playback the signal just recorded and adjust R13 until -10 dBV output is obtained at the TAPE OUT "1" jack.
5. For the remaining tracks, adjust the recording level in the same way.

- TRK1: R13
- TRK2: R23
- TRK3: R33
- TRK4: R43

10-7 OVERALL FREQUENCY RESPONSE

1. Connect the test equipments as shown in Fig. 10-3 and adjust each fader control knob so that -10 dBV is obtained at the LINE OUT jack as mentioned under the item 9-1.
2. Load a blank tape MTT-5061 in the deck.
3. Decrease the input signal level by 10 dB from the reference level or set the input signal level to -30 dBV (31.6mV).
4. Vary the input signal frequency over a range of 40 Hz to 10 kHz and record the frequencies, and then playback the signals just recorded. The playback output levels should be as shown in Fig. 10-4.

* If the output reading is out of the limits, readjust the bias voltage as shown under 10-5. When the output level is lower than the limit, decrease the bias level slightly, and when higher increase the bias slightly. However, recording distortion may increase if the bias voltage is lowered excessively, so make sure the distortion is within the limit, less than 2.5% at 400 Hz.

NOTE: Varying the bias voltage may upset the recording level adjustment, so always make sure the recording level and re-adjust the level again as necessary by referring to the section 10-6.

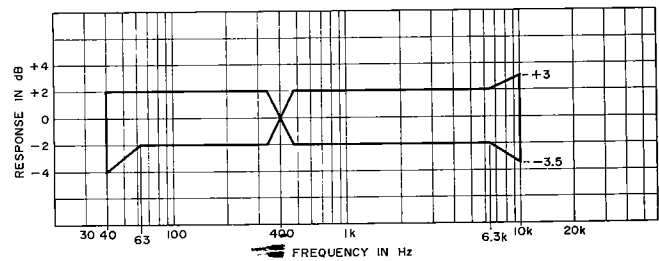

Fig. 10-4 Overall frequency response

10-8 OVERALL DISTORTION

1. Set and adjust the test setup as mentioned under the item 10-7 "Overall Frequency Response".
2. Vary the frequency of the reference input signal to 400 Hz, and record and playback the frequency.
3. Measure the distortion; it should be less than 2.5%.
4. If not:
 - * Readjust the bias voltage.
 - * Try to erase the erase head and record/playback heads, or replace the head(s).
 - * Check for overall S/N.

10-9 OVERALL SN RATIO

1. Set and adjust the test set-up as mentioned under the item "10-7 OVERALL FREQUENCY RESPONSE".
2. Record the reference input signal, and then remove the input plug and continue the recording with no signal applied.
3. Playback both the reference signal and no signal just recorded and read the level difference between the outputs.
4. The difference (SN) should be higher than 43 dB for each channel, when measured through a 20 Hz to 20 kHz filter.
5. If the SN is out of the limit:
 - * Erase the erase head, record/playback heads and tape path with a tape eraser.
 - * Check for normal erasing ratio.
 - * Readjust the bias traps.
 - * Recheck the SN by using another test tape.

10-10 ERASING RATIO

1. Connect test equipments as shown in Fig. 10-5 and adjust the controls and switches as mentioned under the item "10-7 OVERALL FREQUENCY RESPONSE".
2. Adjust the signal generator to provide 1 kHz, 0 dBV (1V) and record it. Playback the signal just recorded and read and note the output level.
3. Rewound the tape up to the beginning of the tape just recorded. Remove the plug from the MIC/LINE jack and then record no signal on the tape just recorded with the 1 kHz signal.
4. Rewound the tape just recorded with no signal and playback it. Read the output level with the level meter sensitivity increased.
5. Compare the output levels obtained in the steps 2 and 4; the level difference should be higher than 65 dB for each channel.

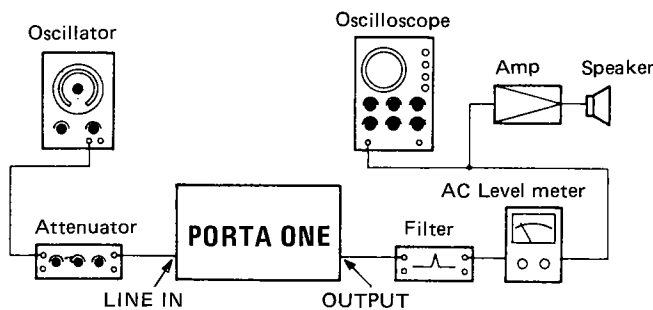

Fig. 10-5 Erasing ratio measurement

6. If not:
 - * Clean the tape transport path.
 - * Check the tape transport mechanism.

10-11 CROSSTALK BETWEEN CHANNELS

1. Set and adjust the test equipment as mentioned under the item "10-7 OVERALL FREQUENCY RESPONSE".
2. Record the reference signal of 1 kHz, -10 dBV (0.3V) on the track 1. Rewound the tape just recorded and playback it. Measure the leakage output levels to the adjacent channels through a 1 kHz filter, and measure ratio(s) against the reference level.
3. The ratio should be higher than 45 dB for each channel.

10-12 SYNC CROSSTALK

This refers to the crosstalk between adjacent tracks when a SYNC recording is made. In other words, it refers to the degree of the bias signal leakage into adjacent tracks from a recording track. Measurement setting is made in the same manner as mentioned under the item "10-7 OVERALL FREQUENCY RESPONSE".

- **Crosstalk between Track #1 and #2**
 - 1) Place the RECORD FUNCTION switch (BUSS L switch) in the "TRK1", and BUSS R switch in the "SAFE" positions.
 - 2) Set the TRK "1" to record/pause mode, and measure the output at the TAPE OUT 2 jack with the TRK "1" set to record mode and the TRK 2 to playback mode.
 - 3) Change the input signal frequency to 10 kHz and check how much of the signal applied to the TRK "1" leaks into the TRK2, or read the level difference against the reference level.
 - 4) The difference should be less than 0 dB at 10 kHz.
- **Crosstalk between Other Tracks**
 - 1) The same method used for measuring crosstalk between TRK1 and TRK2 is used. When measuring crosstalk between other tracks, the RECORD FUNCTION switch should be set as below. Number in parenthesis indicates the setting from the opposite channel.

Setting of RECORD FUNCTION switch

Combination	Record track	Playback track
Between tracks #1 and #2	TRK1	SAFE 2
	(TRK2)	(SAFE 1)
Between tracks #3 and #4	TRK3	SAFE 4
	(TRK4)	(SAFE 3)

10-13 VOLTAGES OF DBX AMPLIFIERS

- **DECODER**
 1. Connect a DC voltmeter between TP1 and TP2 (TRK1, 2) or TP3 (TRK3, 4) and a level meter to the TAPE OUT jack.
 2. Playback the test tape MTT-150 and make sure that the voltage readings at both TP2 and TP3 are 15mV ±5%, respectively. If the voltage reading is out of the limit, adjust the following trim pots:
 - TP2 (TRK1, 2): R12
 - TP3 (TRK3, 4): R32
 3. Also make sure that the output level at the TAPE OUT jack is increased by 5.5 dB ±3 dB from -7 dBV (447mV) when the dbx is actuated.
- **ENCODER**
 1. Connect the DC voltmeter between TP1 and TP4 (LINE OUT L, R).
 2. Adjust each fader control on the front panel so that -10 dBV is obtained at the LINE OUT (L) jack as mentioned under the item 9-1.
 3. Make sure the voltmeter shows DC15mV ±5%. If the voltage reading is out of the limit, adjust R14.

11. EXPLODED VIEW AND PARTS LIST

EXPLODED VIEW-1

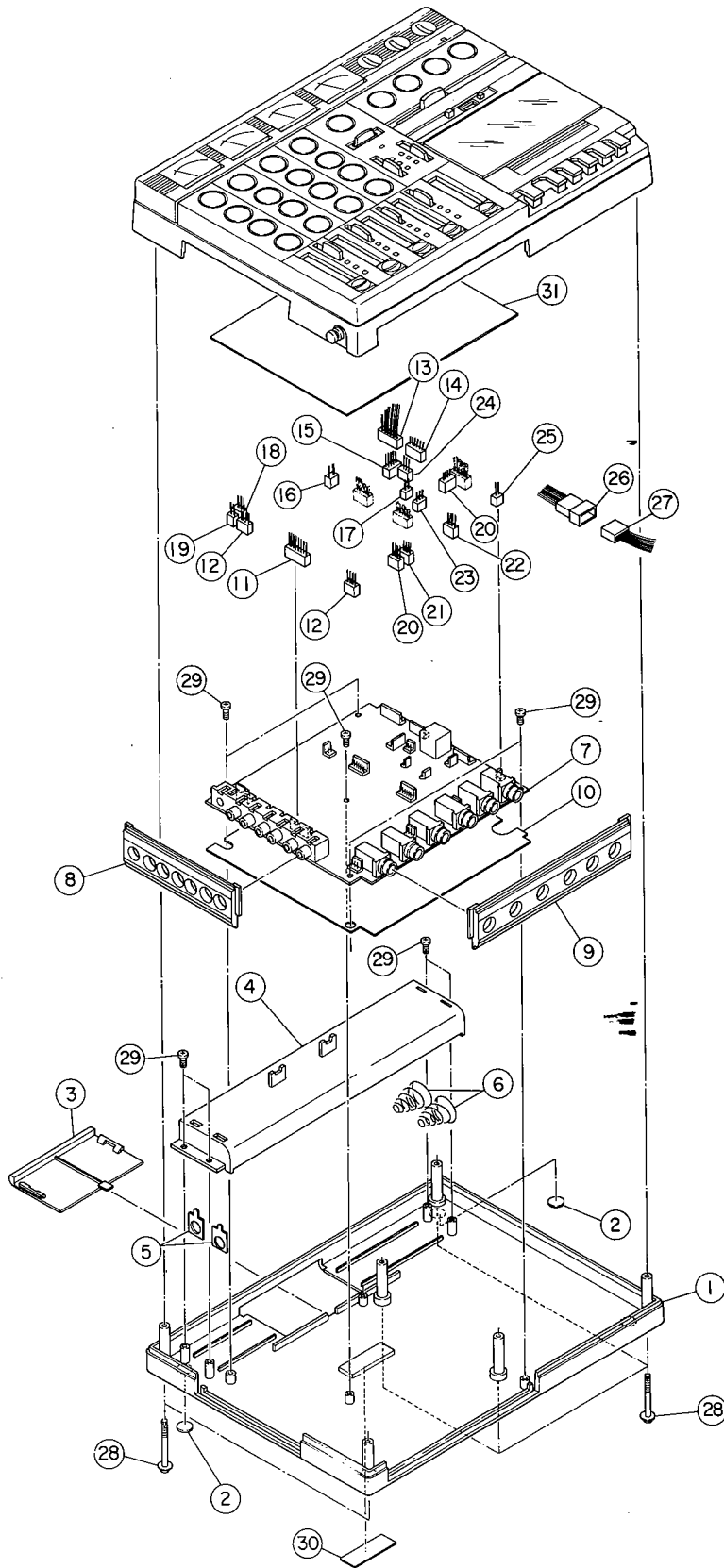

Parts marked with * require longer delivery time.

REF. NO.	PARTS. NO	DESCRIPTION	COMMON MODELS	REMARKS
1 - 1	*5800625500	Case, R		
1 - 2	*5800625601	Foot, Case		
1 - 3	*5800625701	Cover, Battery Case		
1 - 4	5800627901	Case, Battery		
1 - 5	5800628000	Terminal, Battery (+)		
1 - 6	5800628101	Terminal, Battery (-)		
1 - 7	*5200152802	PCB Assy, REC/PLAY Ampl.		
1 - 8	*5800625800	Plate, Pin Jack		
1 - 9	*5800625900	Plate, Mic Jack		
1 - 10	*5800660500	Paper, Shield; B		
1 - 11	*5336124800	Connector Socket, 8P (WHT)		
1 - 12	*5336124400	Connector Socket, 4P (WHT)		
1 - 13	*5336131800	Connector Socket, 8P (RED)		
1 - 14	*5336133600	Connector Socket, 6P (BLK)		
1 - 15	*5336124500	Connector Socket, 5P (WHT)		
1 - 16	*5336131200	Connector Socket, 2P (RED)		
1 - 17	*5336133200	Connector Socket, 2P (BLK)		
1 - 18	*5336124300	Connector Socket, 3P (WHT)		
1 - 19	*5336124200	Connector Socket, 2P (WHT)		
1 - 20	*5336131400	Connector Socket, 4P (RED)		
1 - 21	*5336133400	Connector Socket, 4P (BLK)		
1 - 22	*5336143400	Connector Socket, 4P (YEL)		
1 - 23	*5336133300	Connector Socket, 3P (BLK)		
1 - 24	*5336131300	Connector Socket, 3P (RED)		
1 - 25	*5336143200	Connector Socket, 2P (YEL)		
1 - 26	*5336122500	Connector Socket, 5P		
1 - 27	*5336111500	Connector Plug, 5P		
1 - 28	*5800628500	Screw, Case Stopper		
1 - 29	*5783603008	Screw, Binding Head P-Tite; M3 x 8		
1 - 30	*5720152801	Plate, Number		
1 - 31	*5800679700	Sheet, Wire Protection		

INCLUDED ACCESSORIES

REF. NO.	PARTS NO.	DESCRIPTION	COMMON MODELS	REMARKS
	*5700061800	PORTA ONE Owner's Manual [J]		
	*5700061900	PORTA ONE Owner's Manual [US, C, A]		
	*5700062000	PORTA ONE Owner's Manual [All except J]		

[J] : Japan [US] ; U.S.A. [C] ; CANADA [A] : AUSTRALIA

EXPLODED VIEW-2

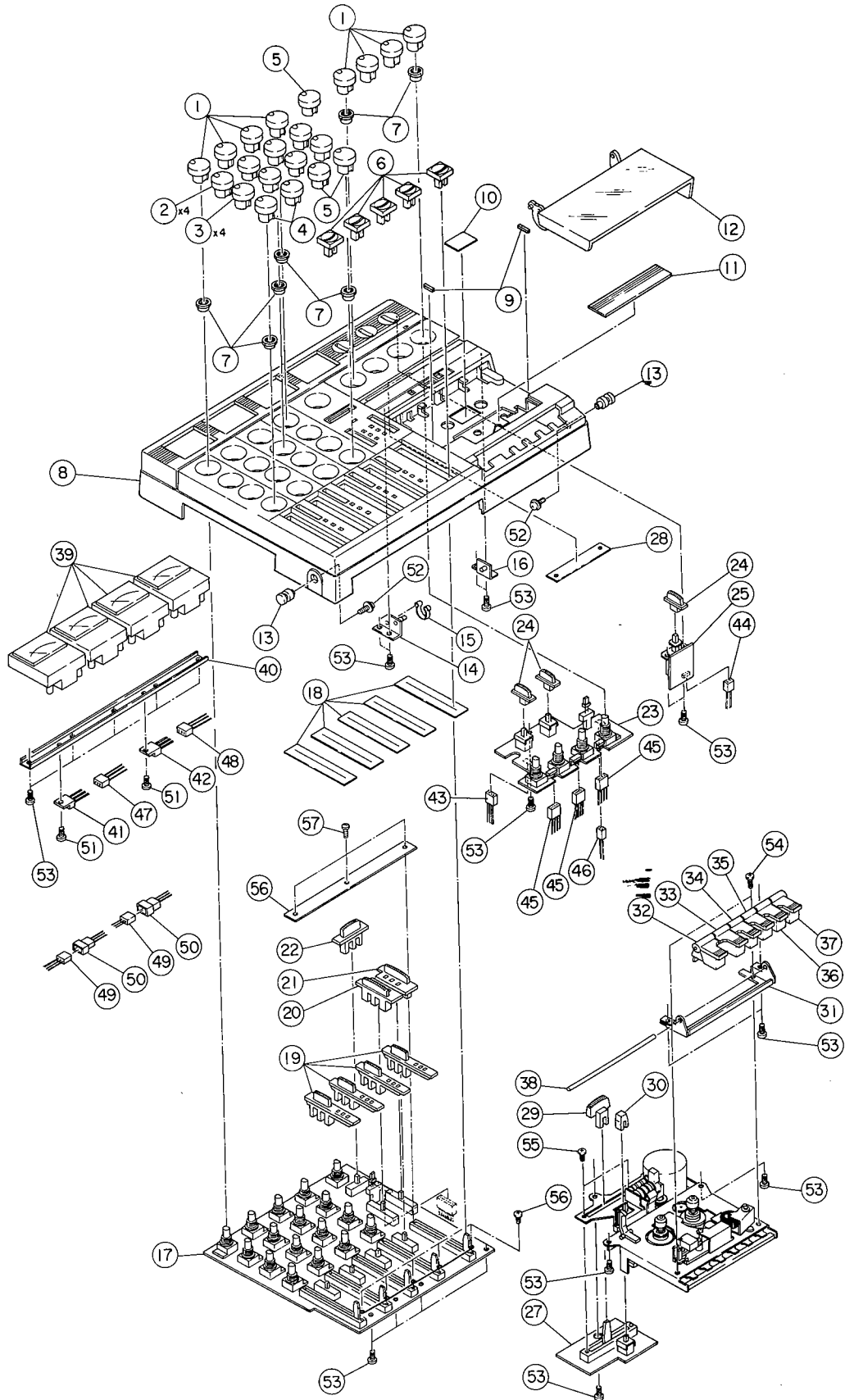

Parts marked with * require longer delivery time.

REF. NO.	PARTS NO.	DESCRIPTION	COMMON MODELS	REMARKS
2- 1	5800627000	Knob Assy, VR; B		
2- 2	5800627100	Knob Assy, VR; C		
2- 3	5800627200	Knob Assy, VR; D		
2- 4	5800627300	Knob Assy, VR; E		
2- 5	5800626900	Knob Assy, VR; A		
2- 6	5800626101	Knob, Slide VR		
2- 7	*5800626000	Nut, VR		
2- 8	*5800624102	Case, F		
2- 9	*5800625301	Cushion		
2-10	*5800602901	Plate, Tape Indication	V-330	
2-11	5800625200	Cover, Head		
2-12	5800624301	Cover, Cassette		
2-13	*5800624200	Hook		
2-14	*5800624401	Bracket Assy, Cover; L		
2-15	5800625101	Spring, Holder		
2-16	*5800624800	Bracket Assy, Cover; R		
2-17	*5200153001	PCB Assy, Mixing Ampl.		
2-18	*5800625400	Cover, VR		
2-19	5800626200	Knob, Input Selector		
2-20	5800626400	Knob, REC Switch; R		
2-21	5800626300	Knob, REC Switch; L		
2-22	5800626500	Knob, Monitor Switch		
2-23	*5200153200	PCB Assy, Cue Ampl.		
2-24	5800626600	Knob, Push		
2-25	*5200153300	PCB Assy, Switch		
2-26				
2-27	*5200152900	PCB Assy, Control		
2-28	*5800628801	Cover, Pitch Control VR		
2-29	5800626800	Knob, Pitch Control VR		
2-30	5800626700	Knob, Memory		
2-31	*5800628900	Frame, Button		
2-32	5800642000	Plate Assy, Button REC; F		
2-33	5800641500	Plate Assy, Button PLAY; A		
2-34	5800641800	Plate Assy, Button REW; D		
2-35	5800641700	Plate Assy, Button FF; C		
2-36	5800641600	Plate Assy, Button STOP; B		
2-37	5800641900	Plate Assy, Button PAUSE; E		
2-38	*5800629000	Shaft, Operation Button		
2-39	5296003300	Meter, VU		
2-40	*5800628200	Holder, Meter		
2-41	5220423400	IC, L7812		
2-42	5220425300	IC, L7810		
2-43	*5336210300	Connector Socket, 3P (WHT)		
2-44	*5122164000	Connector Socket, 2P (WHT)		
2-45	*5336210200	Connector Socket, 4P (WHT)		
2-46	*5336210400	Connector Socket; 2P (WHT)		
2-47	*5336131300	Connector Socket; 3P (RED)		
2-48	*5336124300	Connector Socket; 3P (WHT)		
2-49	*5336111300	Connector Plug; 3P		
2-50	*5336122300	Connector Socket; 3P		
2-51	*5783033006	Screw, Binding Head S-Tite; M3 x 6		
2-52	*5780143006	Screw, Pan Head SEMS-B; M3 x 6		
2-53	*5783603008	Screw, Binding Head P-Tite; M3 x 8		
2-54	*5783002606	Screw, Pan Head S-Tite; M2.6 x 6		
2-55	*5780002004	Screw, Binding Head; M2 x 4		
2-56	*5800677900	Plate, Wire Hold		
2-57	*5780002003	Screw, Binding Head; M2 x 3		

EXPLODED VIEW-3

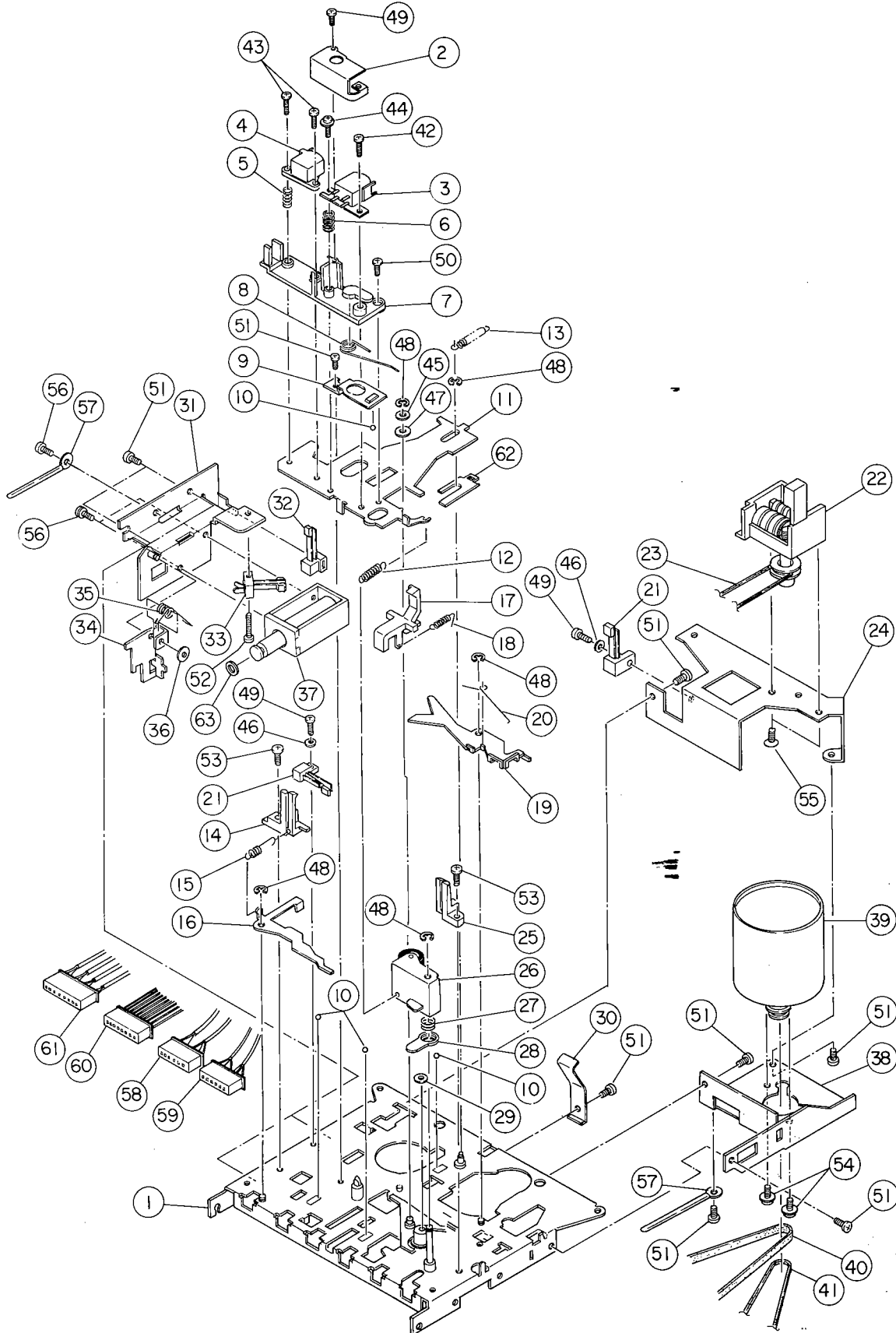

Parts marked with * require longer delivery time.

REF. NO.	PARTS NO.	DESCRIPTION	COMMON MODELS	REMARKS
3 - 1	*5760639500	Chassis Assy		
3 - 2	5800660401	Shield Paper, A		
3 - 3	5378601000	Head, REC/PLAY; 4T4CH		
3 - 4	5378600900	Head, Erase; 4T4CH		
3 - 5	5760644500	Spring, Head		
3 - 6	5760644400	Spring, Head		
3 - 7	5760644200	Base, Head		
3 - 8	5760644300	Spring, Head Base		
3 - 9	*5760644600	Spring, Head Chassis		
3 - 10	5540055000	Bearing, Ball; $\phi 2$	A-450	
3 - 11	5760644101	Chassis, Head		
3 - 12	5760645400	Spring, P Roller		
3 - 13	5760645000	Spring, Brake		
3 - 14	5760644700	Guide, Cassette; DL		
3 - 15	5760644900	Spring, FR Lock Arm		
3 - 16	*5760643900	Arm, FR Lock; N		
3 - 17	*5760645500	Sensor, REC		
3 - 18	*5760645600	Spring, REC Sensor		
3 - 19	*5760643800	Arm, Auto Lock		
3 - 20	5760644000	Spring, Auto Lock Arm		
3 - 21	5760647500	Switch, Leaf		
3 - 22	5760647300	Counter		
3 - 23	5760647200	Belt, Counter		
3 - 24	*5800628701	Mounting Bracket, Counter		
3 - 25	*5860644800	Guide, Cassette; DR		
3 - 26	5760645300	Arm Assy, P Roller		
3 - 27	5760645200	Spring, PAUSE Cam		
3 - 28	*5760645100	Cam, PAUSE		
3 - 29	*5760648500	Washer, Polyslider		
3 - 30	*5760645700	Spring, Pack; F		
3 - 31	*5760646900	Bracket Assy, Solenoid		
3 - 32	5760647700	Switch, Leaf		
3 - 33	5760647600	Switch, Leaf		
3 - 34	*5760647000	Arm, Solenoid		
3 - 35	*5760648900	Spring, Solenoid Arm		
3 - 36	*5760648400	Washer, Polyslider		
3 - 37	5760647100	Solenoid		
3 - 38	*5760645800	Bracket, Motor; A		
3 - 39	5760645900	Motor Assy		
3 - 40	5760646100	Belt, Drive <i>CD</i>		
3 - 41	5760646300	Belt		
3 - 42	*5760648600	Screw, Binding Head; M2 x 9		
3 - 43	*5760648700	Screw, Binding Head; M2 x 9.5		
3 - 44	*5760648800	Screw, Washer Head; M2 x 9		
3 - 45	*5760647900	Washer, Nylon		
3 - 46	*5785002000	Washer, M2 (t0.4)		
3 - 47	*5785003000	Washer, M3 (t0.5)		
3 - 48	*5786002500	E-Ring, E-2.5		
3 - 49	*5783002006	Screw, Pan Head S-Tite; M2 x 6		
3 - 50	*5783522604	Screw, Pan Head S-Tite; M2.6 x 4 (BLK Ni)		
3 - 51	*5783002604	Screw, Pan Head S-Tite; M2.6 x 4		
3 - 52	*5783002008	Screw, Pan Head S-Tite; M2 x 8		
3 - 53	*5783532608	Screw, Binding Head B-Tite; M2.6 x 8 (BLK Ni)		
3 - 54	*5780162603	Screw, Pan Head SEMS-C; M2.6 x 3		
3 - 55	*5781202606	Screw, Flat Countersunk Head Tapping; M2.6 x 6		
3 - 56	*5780132604	Screw, Pan Head SEMS-A; M2.6 x 4		
3 - 57	*5760647400	Clamp, Cord		
3 - 58	*5336124600	Connector Socket, 6P (WHT)		
3 - 59	*5336131600	Connector Socket, 6P (RED)		
3 - 60	*5336124700	Connector Socket, 7P (WHT)		
3 - 61	*5336124800	Connector Socket, 8P (WHT)		
3 - 62	*5760908900	Vessel, Idler		
3 - 63	*5760908800	Washer, Rubber		

EXPLODED VIEW-4

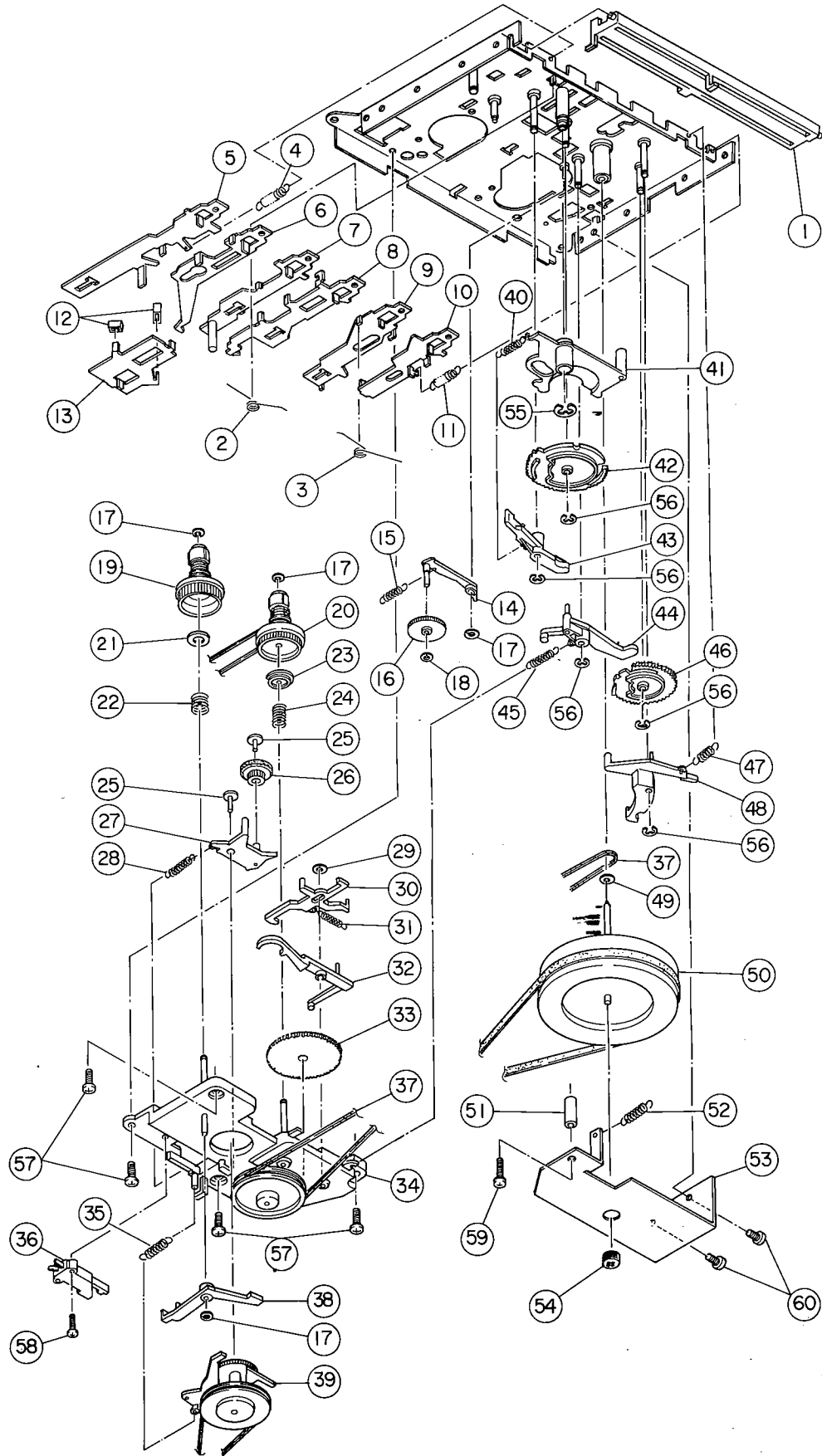

Parts marked with * require longer delivery time.

REF. NO.	PARTS NO.	DESCRIPTION	COMMON MODELS	REMARKS
4 - 1	*5760646700	Cam, Lock; V		
4 - 2	*5760640300	Spring, Lever; D		
4 - 3	*5760640400	Spring, Lever; F		
4 - 4	*5760640200	Spring, REC Lever		
4 - 5	*5760640100	Lever, REC		
4 - 6	*5760640000	Lever, PLAY		
4 - 7	*5760639900	Lever Assy, REW		
4 - 8	*5760639800	Lever, FF		
4 - 9	*5760639700	Lever, STOP		
4 - 10	*5760639600	Lever Assy PAUSE		
4 - 11	*5760640500	Spring, PAUSE Lever		
4 - 12	5760641500	Shoe, Brake		
4 - 13	*5760641400	Lever, Brake		
4 - 14	*5760641600	Arm Assy, FF Idler		
4 - 15	*5760641800	Spring, FF Gear		
4 - 16	5760641700	Gear, FF		
4 - 17	5760648100	Washer, Polyslider		
5 - 18	5760648000	Washer, Polyslider		
4 - 19	5760643200	Reel Assy, Supply		
4 - 20	5760643100	Reel Assy, Take-up		
4 - 21	5760647800	Washer, Reel		
4 - 22	5760643600	Spring, Back Tension		
4 - 23	5760642500	Clutch Assy, Auto		
4 - 24	5760642600	Spring, Tension		
4 - 25	5760642700	Bush		
4 - 26	5760642900	Idler, PLAY		
4 - 27	*5760642800	Arm, PLAY		
4 - 28	5760643000	Spring, PLAY Arm		
4 - 29	5760648300	Washer, Polyslider		
4 - 30	*5760642300	Arm, Auto		
4 - 31	5760642400	Spring, Auto Arm		
4 - 32	*5760642200	Arm, Sensor		
4 - 33	*5760642100	Gear, Auto		
4 - 34	*5760641900	Base Assy, Reel		
4 - 35	*5760643300	Spring, FR Pulley Arm; C		
4 - 36	5760642000	Switch, Quick Action		
4 - 37	5760646200	Belt		
4 - 38	*5760643500	Arm, REW		
4 - 39	5760643400	FR Pulley Arm; D		
4 - 40	*5760641200	Spring, Shift Arm A		
4 - 41	*5760640600	Arm, Shift; A		
4 - 42	5760640900	Gear, B		
4 - 43	*5760641000	Arm, Gear Lock; A		
4 - 44	*5760640700	Arm, Shift; B		
4 - 45	*5760643700	Spring, Shift Lock B		
4 - 46	5760640800	Gear, A		
4 - 47	*5760641300	Spring, Lock Arm B		
4 - 48	*5760641100	Arm, Gear Lock; B		
4 - 49	5760648200	Washer, Polyslider		
4 - 50	*5760646000	Flywheel		
4 - 51	*5760646600	Coller, Flywheel Bracket		
4 - 52	*5760646800	Spring, Lock Cam		
4 - 53	*5760646400	Bracket, Flywheel; D		
4 - 54	5760646500	Screw, Capstan		
4 - 55	*5786004000	E-Ring, E-4		
4 - 56	*5786002000	E-Ring, E-2		
4 - 57	*5783532608	Screw, Binding Head B-Tite; M2.6 x 8 (BLK Ni)		
4 - 58	*5783002012	Screw, Pan Head S-Tite; M2 x 6		
4 - 59	*5780132614	Screw, Pan Head SEMS-A; M2.6 x 14		
4 - 60	*5783002604	Screw, Pan Head S-Tite; M2.6 x 4		

12. IC INTERNAL CIRCUIT

LBI214

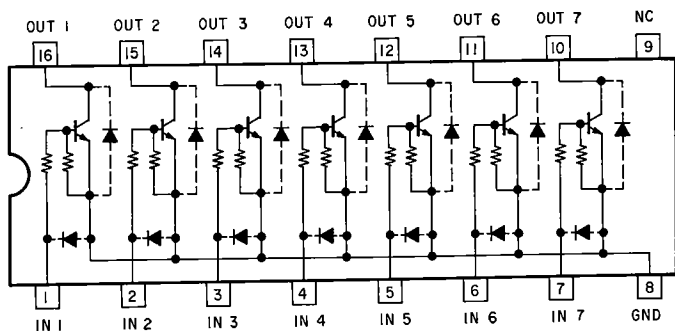

M5218L

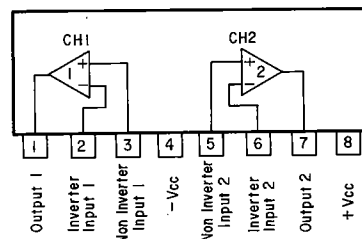

HDI4069UBP

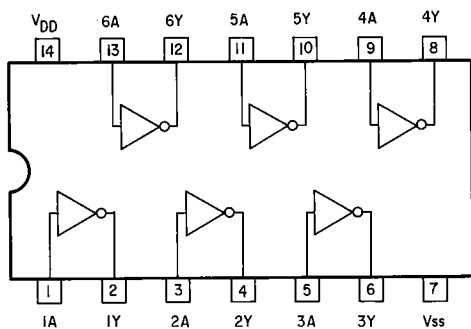

M5232L

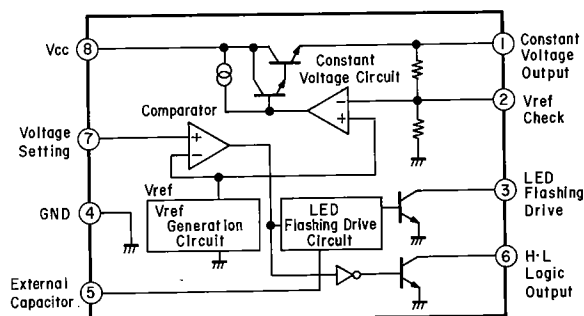

AN6291

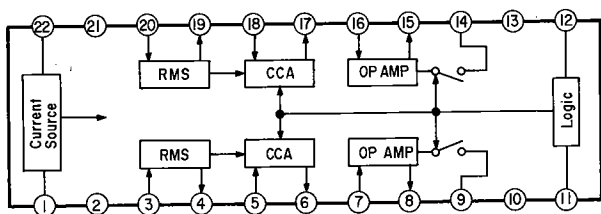

M5219L

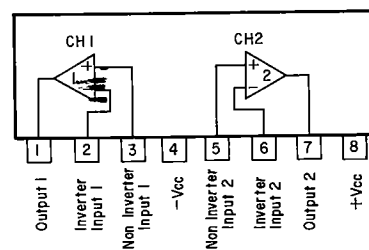

NJM386D

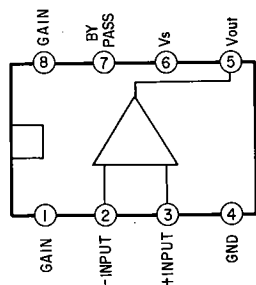

2SC3402

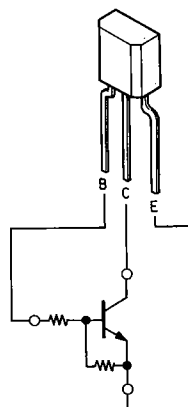

13. PC BOARDS AND PARTS LIST

R/P AMPL. PCB ASS'Y

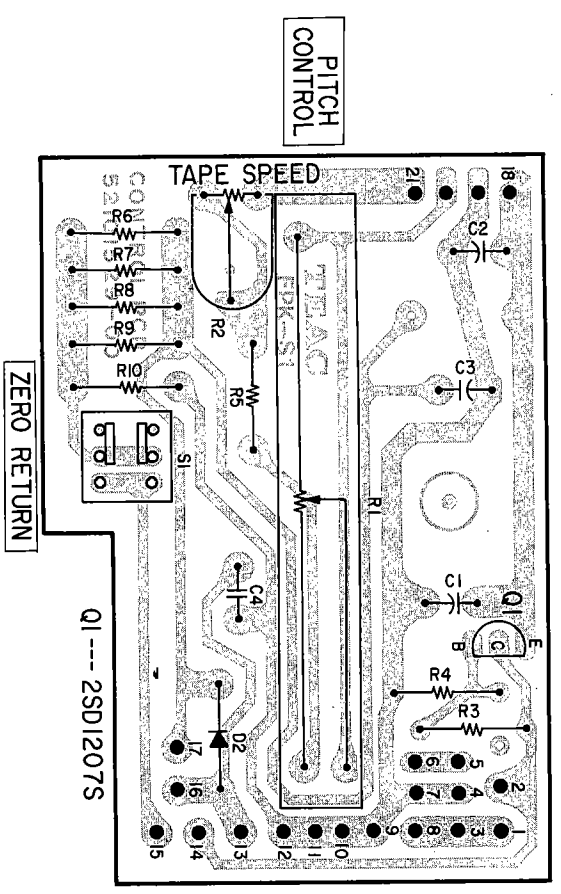
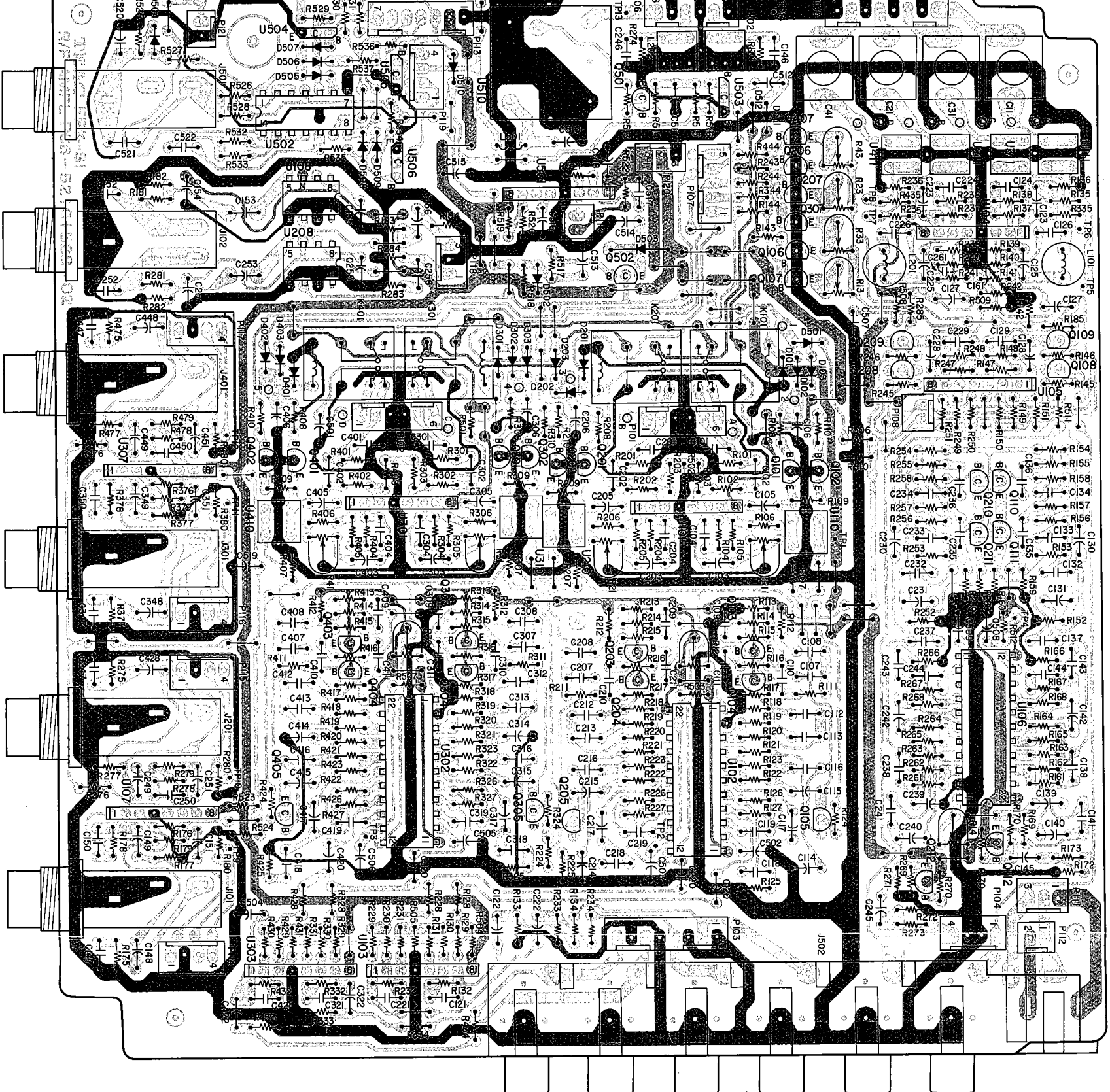

CONTROL PCB ASS'Y

- NOTES**
1. PC boards are shown viewed from foil side.
 2. The colors on the PC board illustrations have the following significance:
 - : +B power supply circuit
 - : GND
 - : other

MINISTUDIO
PORTA ONE

MIXING AMPL. PCB ASS'Y

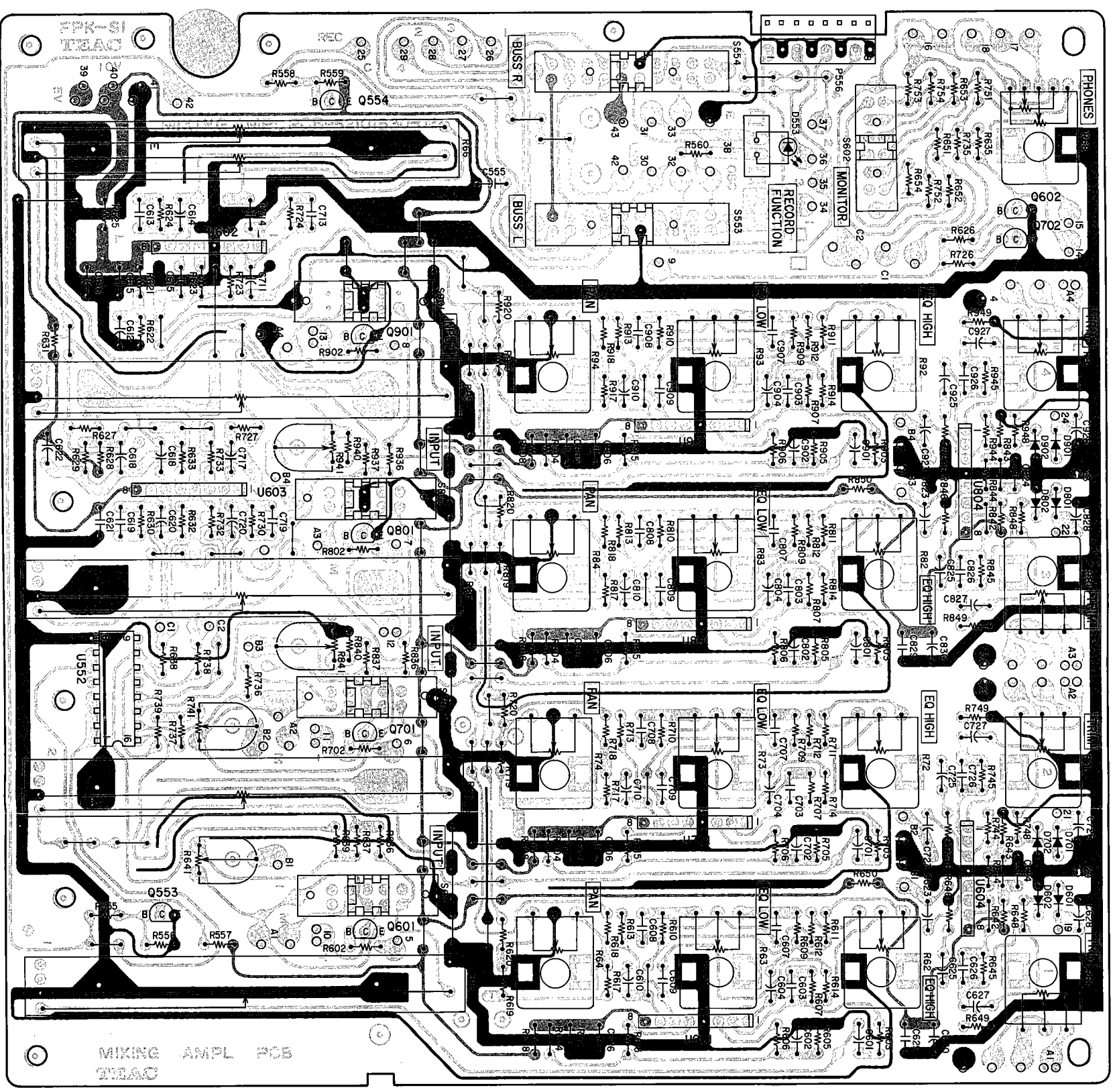

MIXING AMPL PCB
TEAC

TAPE CUE AMPL. PCB ASS'Y

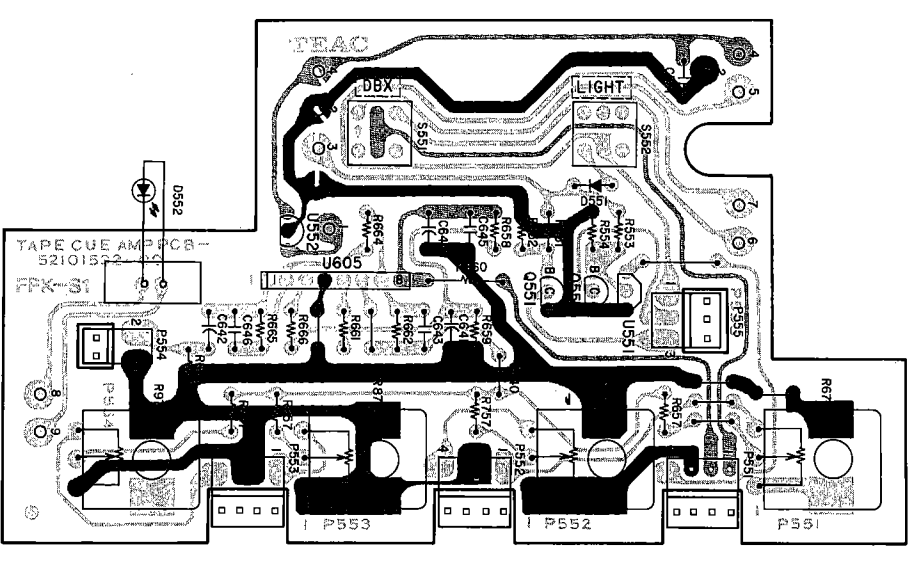

TAPE CUE AMPL PCB -
52101522

SWITCH PCB ASS'Y

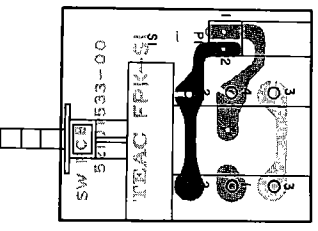

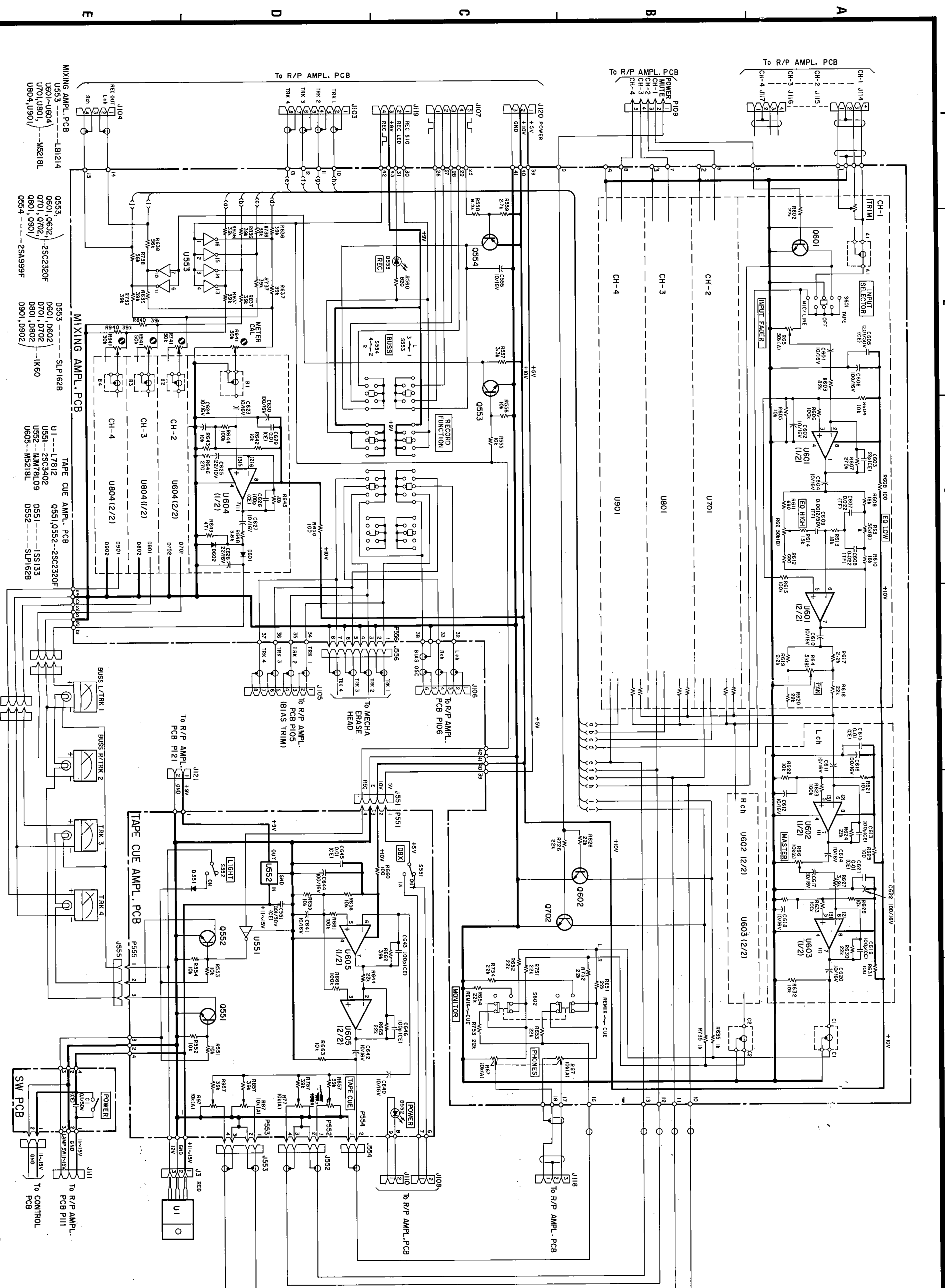

U1 M7810
 Q1 2SD1207S
 D2 DS135D

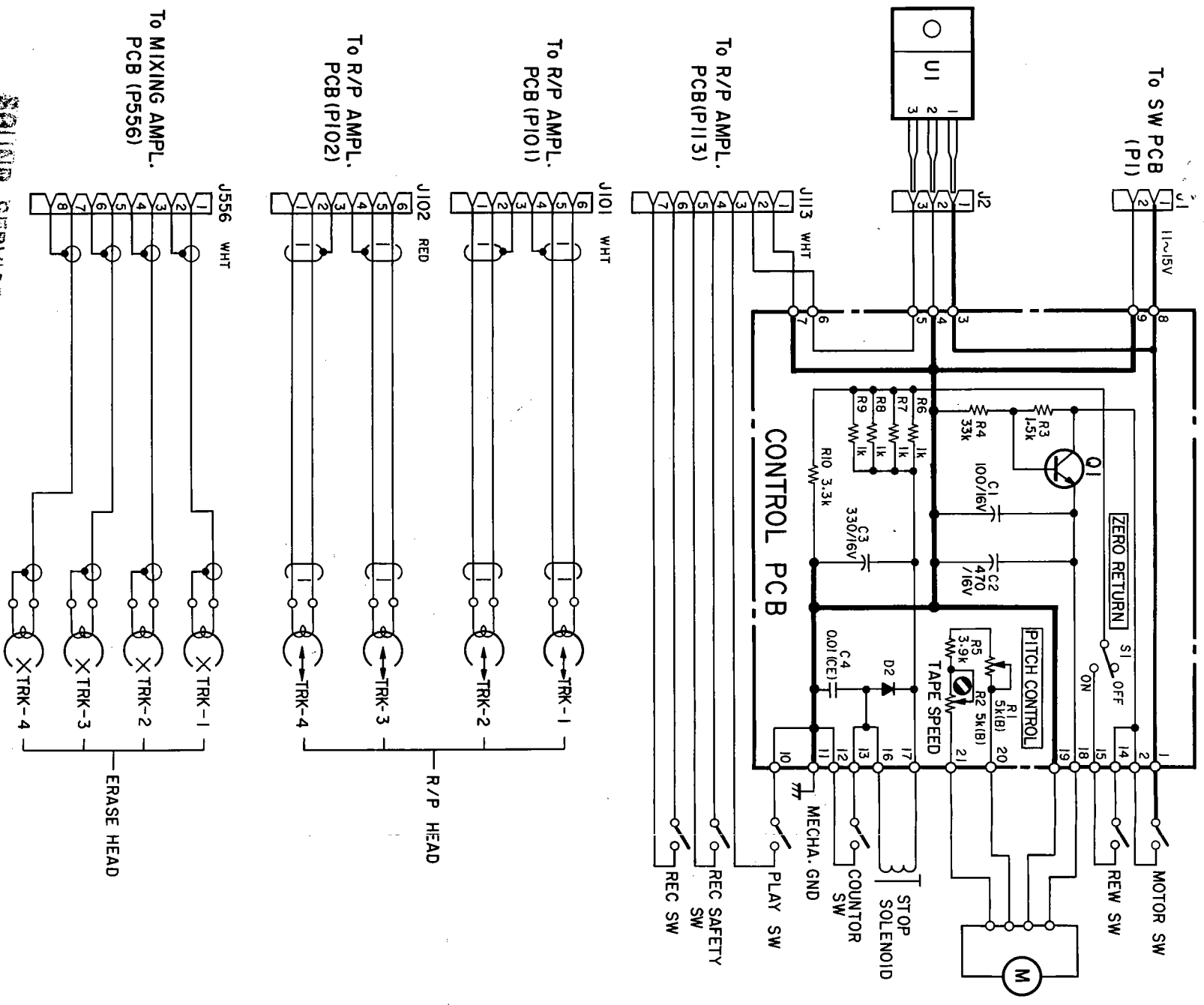

OUND SERVICE CENTER
 31525 SHERMAN WAY
 CANOGA PARK, CALIF. 91301

R/P AMPL. PCB ASSY

REF. NO.	PARTS NO.	DESCRIPTION
	*5200152800	PCB Assy
	*5210152801	PCB
IC's		
U101, U301	5220417300	M5219L
U102, U302	5220423100	AN6291
U103, U303	5220416200	M5218L
U104	5220416200	M5218L
U105	5220416200	M5218L
U106	5220423100	AN6291
U107, U307	5220416200	M5218L
U108, U208	6048649000	NJM386D
U501	5220423600	M5232L
U502	5220017200	HD14069UBP
U503	5232252220	2SC3402
U504	5232252220	2SC3402
U505	5232252220	2SC3402
U506	5232252220	2SC3402
TRANSISTORS		
Q101, Q201	5231761400	2SD1302S
Q301, Q401	5231761400	2SD1302S
Q102, Q202	5230778300	2SC2320F
Q302, Q402	5230778300	2SC2320F
Q103, Q203	5230778300	2SC2320F
Q303, Q403	5230778300	2SC2320F
Q104, Q204	5230778300	2SC2320F
Q304, Q404	5230778300	2SC2320F
Q105, Q205	5232008000	FET, 2SJ40E
Q305, Q405	5232008000	FET, 2SJ40E
Q106, Q206	5231761400	2SD1302S
Q107, Q207	5230778300	2SC2320F
Q307, Q407	5230778300	2SC2320F
Q108, Q208	5232008000	FET, 2SJ40E
Q109, Q209	5232008000	FET, 2SJ40E
Q110, Q210	5230778300	2SC2320F
Q111, Q211	5230778300	2SC2320F
Q102, Q212	5230778300	2SC2320F
Q501	5231761400	2SD1302S
Q502	5230016620	2SA999F
DIODES		
D101, D201	5224015020	1SS133
D301, D401	5224015020	1SS133
D102, D202	5224015020	1SS133
D302, D402	5224015020	1SS133
D103, D203	5224015020	1SS133
D303, D403	5224015020	1SS133
D501	5224015020	1SS133
D502	5224015020	1SS133
D503	5224013210	DS135D
D504	5224015020	1SS133
D505	5224015020	1SS133
D506	5224015020	1SS133
D507	5224015020	1SS133
D508	5224015020	1SS133
D509	5224015020	1SS133
D510	5224015020	1SS133
D511	5224015020	1SS133
D512	5224015020	1SS133
D513	5224013210	DS135D

REF. NO.	PARTS NO.	DESCRIPTION
CARBON RESISTORS		
All resistors are rated $\pm 5\%$ tolerance and 1/4 watt.		
R101, R201	5240033020	100k Ω
R301, R401	5240033020	100k Ω
R102, R202	5240025820	100 Ω
R302, R402	5240025820	100 Ω
R103, R203	5240033020	100k Ω
R303, R403	5240033020	100k Ω
R104, R204	5240034220	330k Ω
R304, R404	5240034220	330k Ω
R105, R205	5240030220	6.8k Ω
R305, R405	5240030220	6.8k Ω
R106, R206	5240027620	560 Ω
R306, R406	5240027620	560 Ω
R107, R207	5240030020	5.6k Ω
R307, R407	5240030020	5.6k Ω
R108, R208	5240031420	22k Ω
R308, R408	5240031420	22k Ω
R109, R209	5240027620	560 Ω
R309, R409	5240027620	560 Ω
R110, R210	5240031420	22k Ω
R310, R410	5240031420	22k Ω
R111, R211	5240031820	33k Ω
R311, R411	5240031820	33k Ω
R112, R212	5240033420	150k Ω
R312, R412	5240033420	150k Ω
R113, R213	5240033920	240k Ω
R313, R413	5240033920	240k Ω
R114, R214	5240029820	4.7k Ω
R314, R414	5240029820	4.7k Ω
R115, R215	5240031020	15k Ω
R315, R415	5240031020	15k Ω
R116, R216	5240031020	15k Ω
R316, R416	5240031020	15k Ω
R117, R217	5240029420	3.3k Ω
R317, R417	5240029420	3.3k Ω
R118, R218	5240029420	3.3k Ω
R318, R418	5240029420	3.3k Ω
R119, R219	5240028220	1k Ω
R319, R419	5240028220	1k Ω
R120, R220	5240030620	10k Ω
R320, R420	5240030620	10k Ω
R121, R221	5240023420	10 Ω
R321, R421	5240023420	10 Ω
R122, R222	5240031020	15k Ω
R322, R422	5240031020	15k Ω
R123, R223	5240029820	4.7k Ω
R323, R423	5240029820	4.7k Ω
R124, R224	5240034620	470k Ω
R324, R424	5240034620	470k Ω
R125, R225	5240026220	150 Ω
R325, R425	5240026220	150 Ω
R126, R226	5240029820	4.7k Ω
R326, R426	5240029820	4.7k Ω
R127, R227	5240031020	15k Ω
R327, R427	5240031020	15k Ω
R128, R228	5240025820	100 Ω
R328, R428	5240025820	100 Ω
R129, R229	5240033020	100k Ω
R329, R429	5240033020	100k Ω
R130, R230	5240030620	10k Ω
R330, R430	5240030620	10k Ω

Parts marked with * require longer delivery time.

REF. NO.	PARTS NO.	DESCRIPTION
R131, R231	5240033020	100kΩ
R331, R431	5240033020	100kΩ
R132, R232	5240033220	120kΩ
R332, R432	5240033220	120kΩ
R133, R233	5240031820	33kΩ
R333, R433	5240031820	33kΩ
R134, R234	5240028220	1kΩ
R334, R434	5240028220	1kΩ
R135, R235	5240030420	8.2kΩ
R335, R435	5240030420	8.2kΩ
R136, R236	5240030620	10kΩ
R137, R237	5240031820	33kΩ
R138, R238	5240033420	150kΩ
R139, R239	5240028020	820Ω
R140, R240	5240029020	2.2kΩ
R141, R241	5240033020	100kΩ
R142, R242	5240031820	33kΩ
R143, R243	5240030620	10kΩ
R144, R244	5240031420	22kΩ
R344, R444	5240031420	22kΩ
R145, R245	5240034620	470kΩ
R146, R246	5240034620	470kΩ
R147, R247	5240033020	100kΩ
R148, R248	5240033020	100kΩ
R149, R249	5240030620	10kΩ
R150, R250	5240033020	100kΩ
R151, R251	5240025820	100Ω
R152, R252	5240030420	8.2kΩ
R153, R253	5240031820	33kΩ
R154, R254	5240033420	150kΩ
R155, R255	5240033920	240kΩ
R156, R256	5240029820	4.7kΩ
R157, R257	5240031020	15kΩ
R158, R258	5240031020	15kΩ
R159, R259	5240029420	3.3kΩ
R160, R260	5240029420	3.3kΩ
R161, R261	5240028220	1kΩ
R162, R262	5240030620	10kΩ
R163, R263	5240023420	10Ω
R164, R264	5240031020	15kΩ
R165, R265	5240029820	4.7kΩ
R166, R266	5240026220	150Ω
R167, R267	5240029820	4.7kΩ
R168, R268	5240031020	15kΩ
R169, R269	5240029420	3.3kΩ
R170, R270	5240033020	100kΩ
R171, R271	5240033220	120kΩ
R172, R272	5240028220	1kΩ
R173, R273	5240030620	10kΩ
R174, R274	5240031420	22kΩ
R175, R275	5240030820	12kΩ
R375, R475	5240030820	12kΩ
R176, R276	5240033020	100kΩ
R376, R476	5240033020	100kΩ
R177, R277	5240033020	100kΩ
R377, R477	5240033020	100kΩ
R178, R278	5240033020	100kΩ
R378, R478	5240033020	100kΩ
R179, R279	5240027420	470Ω
R379, R479	5240027420	470Ω

REF. NO.	PARTS NO.	DESCRIPTION
R180, R280	5240025620	82Ω
R380, R480	5240025620	82Ω
R181, R281	5240021020	1Ω
R182, R282	5240028220	1kΩ
R183, R283	5240033820	220kΩ
R184, R284	5240033820	220kΩ
R185, R285	5240031820	33kΩ
R501	5240030620	10kΩ
R502	5240030620	10kΩ
R503	5240068220	1kΩ 2%
R504	5240030620	10kΩ
R505	5240030620	10kΩ
R506	5240030620	10kΩ
R507	5240068220	1kΩ 2%
R508	5240030620	10kΩ
R509	5240030620	10kΩ
R510	5240034620	470kΩ
R511	5240034620	470kΩ
R512	5240068220	1kΩ 2%
R513	5240022220	3.3Ω
R515	5240030620	10kΩ
R516	5240030620	10kΩ
R517	5240033020	100kΩ
R518	5240033020	100kΩ
R519	5240032920	91kΩ
R520	5240031020	15kΩ
R521	5240031020	15kΩ
R522	5240027020	330Ω
R523	5240030620	10kΩ
R524	5240030620	10kΩ
R525	5240031820	33kΩ
R526	5240030020	5.6kΩ
R527	5240030620	10kΩ
R528	5240030620	10kΩ
R529	5240029420	3.3kΩ
R530	5240030620	10kΩ
R531	5240028220	1kΩ
R532	5240034620	470kΩ
R533	5240031820	33kΩ
R534	5240030620	10kΩ
R535	5240030620	10kΩ
R536	5240030620	10kΩ
R537	5240028220	1kΩ
CAPACITORS		
C11, C21	5267206300	Trimmer 180pF
C31, C41	5267206300	Trimmer 180pF
C101, C201	5172216000	Ceramic 220pF 50V 10%
C301, C401	5172216000	Ceramic 220pF 50V 10%
C102, C202	5260212350	Elec. 10μF 16V
C302, C402	5260212350	Elec. 10μF 16V
C103, C203	5260213750	Elec. 33μF 16V
C303, C403	5260213750	Elec. 33μF 16V
C104, C204	5171856000	Mylar 0.01μF 100V 5%
C304, C404	5171856000	Mylar 0.01μF 100V 5%
C105, C205	5260212350	Elec. 10μF 16V
C305, C405	5260212350	Elec. 10μF 16V
C106, C206	5260212350	Elec. 10μF 16V
C306, C406	5260212350	Elec. 10μF 16V
C107, C207	5263167923	Metalized 0.1μF 50V 5%

REF NO.	PARTS NO.	DESCRIPTION
C307, C407	5263167923	Metalized 0.1μF 50V 5%
C108, C208	5263167923	Metalized 0.1μF 50V 5%
C308, C408	5263167923	Metalized 0.1μF 50V 5%
C109, C209	5170364000	Mylar 0.0033μF 100V 5%
C309, C409	5170364000	Mylar 0.0033μF 100V 5%
C110, C210	5170364000	Mylar 0.0033μF 100V 5%
C310, C410	5170364000	Mylar 0.0033μF 100V 5%
C111, C211	5263106620	Poly. 330pF 100V 5%
C311, C411	5263106620	Poly. 330pF 100V 5%
C112, C212	5263168523	Metalized 0.33μF 50V 5%
C312, C412	5263168523	Metalized 0.33μF 50V 5%
C113, C213	5171868000	Mylar 0.033μF 100V 5%
C313, C413	5171868000	Mylar 0.033μF 100V 5%
C114, C214	5260227010	Elec. 10μF 35V
C314, C414	5260227010	Elec. 10μF 35V
C115, C215	5260221050	Elec. 0.68μF 50V
C315, C415	5260221050	Elec. 0.68μF 50V
C116, C216	5172220000	Ceramic 470pF 50V 10%
C316, C426	5172220000	Ceramic 470pF 50V 10%
C117, C217	5260214850	Elec. 100μF 16V
C317, C417	5260214850	Elec. 100μF 16V
C118, C218	5170368000	Mylar 0.0047μF 100V 5%
C318, C418	5170368000	Mylar 0.0047μF 100V 5%
C119, C219	5171864000	Mylar 0.022μF 100V 5%
C319, C419	5171864000	Mylar 0.022μF 100V 5%
C120, C220	5260212350	Elec. 10μF 16V
C320, C420	5260212350	Elec. 10μF 16V
C121, C221	5172206000	Ceramic 33pF 50V 10%
C321, C421	5172206000	Ceramic 33pF 50V 10%
C122, C222	5260212350	Elec. 10μF 16V
C322, C422	5260212350	Elec. 10μF 16V
C123, C223	5260212350	Elec. 10μF 16V
C124, C224	5263167923	Metalized 0.1μF 50V 5%
C125, C225	5260212350	Elec. 10μF 16V
C126, C226	5170370800	Mylar 0.0056μF 100V 5%
C127, C227	5260212350	Elec. 10μF 16V
C128, C228	5260212350	Elec. 10μF 16V
C129, C229	5172206000	Ceramic 33pF 50V 10%
C130, C230	5260212350	Elec. 10μF 16V
C131, C231	5260212350	Elec. 10μF 16V
C132, C232	5263167923	Metalized 0.1μF 50V 5%
C133, C233	5263167923	Metalized 0.1μF 50V 5%
C134, C234	5170364000	Mylar 0.0033μF 100V 5%
C135, C235	5170364000	Mylar 0.0033μF 100V 5%
C136, C236	5263106620	Poly. 330pF 100V 5%
C137, C237	5263168523	Metalized 0.33μF 50V 5%
C138, C238	5171868000	Mylar 0.033μF 100V 5%
C139, C239	5260227010	Elec. 10μF 35V
C140, C240	5260221050	Elec. 0.68μF 50V
C141, C241	5171864000	Mylar 0.022μF 100V 5%
C142, C242	5260214850	Elec. 100μF 16V
C143, C243	5170368000	Mylar 0.0047μF 100V 5%
C144, C244	5263106820	Poly. 390pF 100V 5%
C145, C245	5260210650	Elec. 0.22μF 50V
C146, C246	5172214000	Ceramic 150pF 50V 10%
C147, C247	5172224000	Ceramic 0.001μF 50V 10%
C347, C447	5172224000	Ceramic 0.001μF 50V 10%
C148, C248	5260212350	Elec. 10μF 16V
C348, C448	5260212350	Elec. 10μF 16V
C149, C249	5260212350	Elec. 10μF 16V

REF. NO.	PARTS NO.	DESCRIPTION
C349, C449	5260212350	Elec. 10μF 16V
C150, C250	5172204000	Ceramic 22pF 50V 10%
C350, C450	5172204000	Ceramic 22pF 50V 10%
C151, C251	5260212350	Elec. 10μF 16V
C351, C451	5260212350	Elec. 10μF 16V
C152, C252	5173435000	Ceramic 0.047μF 50V
C153, C253	5260166852	Elec. 220μF 10V
C154, C254	5260214850	Elec. 100μF 16V
C155, C255	5260212350	Elec. 10μF 16V
C156, C256	5260212350	Elec. 10μF 16V
C161, C261	5170372000	Mylar 0.0068μF
C501	5260214850	Elec. 100μF 16V
C502	5260211250	Elec. 1μF 50V
C503	5260212350	Elec. 10μF 16V
C504	5260214850	Elec. 100μF 16V
C505	5260211250	Elec. 1μF 50V
C506	5260212350	Elec. 10μF 16V
C507	5260214850	Elec. 100μF 16V
C508	5260212350	Elec. 10μF 16V
C509	5260211250	Elec. 1μF 50V
C510	5260211250	Elec. 1μF 50V
C511	5260211450	Elec. 2.2μF 50V
C512	5260211450	Elec. 2.2μF 50V
C513	5260214350	Elec. 47μF 16V
C514	5260214350	Elec. 47μF 16V
C515	5173054800	Elec. 220μF 16V
C516	5260211950	Elec. 4.7μF 25V
C517	5172212000	Ceramic 100pF 50V 10%
C518	5260214850	Elec. 100μF 16V
C519	5260214850	Elec. 100μF 16V
C520	5260211450	Elec. 2.2μF 50V
C521	5173433000	Ceramic 0.01μF 50V
C522	5260217850	Elec. 10μF 16V
RELAYS		
K101, K201	5290011500	G5A-137P
K301, K401	5290011500	G5A-137P
VARIABLE RESISTORS		
R11, R21	5280020300	Semi-fixed 220Ω (B)
R31, R41	5280020300	Semi-fixed 220Ω (B)
R12, R32	5280020300	Semi-fixed 2.2kΩ (B)
R13, R23	5280021300	Semi-fixed 10kΩ (B)
R33, R43	5280021300	Semi-fixed 10kΩ (B)
R14	5280020900	Semi-fixed 2.2kΩ (B)
COILS		
U110, U210	5292204000	Trap 60 kHz
U310, U410	5292204000	Trap 60 kHz
U111, U211	5292204000	Trap 60 kHz
U311, U411	5292204000	Trap 60 kHz
L101, L201	5286010200	Choke 36mH
L102, L202	5286023600	Choke 2.0mH
L501	5286006700	Choke 1.2mH
CONNECTOR PLUGS		
P101	5336126600	6P (WHT)
P102	5336135600	6P (RED)
P103	5336126800	8P (WHT)
P104	5336126400	4P (WHT)
P105	5336135800	8P (RED)

REF. NO.	PARTS NO.	DESCRIPTION
P106	5336137600	6P (BLK)
P107	5336126500	5P (WHT)
P108	5336135200	2P (RED)
P110	5336137200	2P (BLK)
P111	5336126300	3P (WHT)
P112	5336126200	2P (WHT)
P113	5336126700	7P (WHT)
P114	5336126400	4P (WHT)
P115	5336135400	4P (RED)
P116	5336137400	4P (BLK)
P117	5336145400	4P (YEL)
P118	5336137300	3P (BLK)
P119	5336135400	4P (RED)
P120	5336135300	3P (RED)
P121	5336145200	2P (YEL)
MISCELLANEOUS		
U510	5292203900	OSC, Module; 60 kHz
J101, J201	5330010800	Jack, Single-Pole
J301, J401	5330010800	Jack, Single-Pole
J102	5330009000	Jack, 3-Poles
J502	5327007700	Terminal, IN-OUT
TP1 ~ TP12	5544750000	Combination Pin Jumper
	5181761000	

SWITCH PCB ASSY

REF. NO.	PARTS NO.	DESCRIPTION
	*5200153300	PCB Assy
	*5210153300	PCB
C1	5267010400	Capacitor, Ceramic; 0.1 μ F 50V
P1	5336128200	Connector, Plug; 2P (WHT)
S1	5300038100	Switch, Push; SDW1P
	5783603008	Screw, P-tite Bind; M3 x 8

MIXING AMPL. PCB ASSY

REF. NO.	PARTS NO.	DESCRIPTION
	*5200153000	PCB Assy
	*5210153001	PCB
IC's		
U552	5232252300	Transistor Array, LB1214
U601, U701	5220416200	M5218L
U801, U901	5220416200	M5218L
U602	5220416200	M5218L
U603	5220416200	M5218L
U604, U804	5220416200	M5218L
TRANSISTORS		
Q553	5230778300	2SC2320F
Q554	5230016620	2SA999F
Q601, Q701	5230778300	2SC2320F
Q801, Q901	5230778300	2SC2320F
Q602, Q702	5230778300	2SC2320F
DIODES		
D553	5225013900	SLP162B
D601, D701	5224015400	1K60
D801, D901	5224015400	1K60
D602, D702	5224015400	1K60
D802, D902	5224015400	1K60
CARBON RESISTORS		
All resistors are rated \pm 5% tolerance and 1/4 watt.		
R555	5240030620	10k Ω
R556	5240030620	10k Ω
R557	5240029420	3.3k Ω
R558	5240030420	8.2k Ω
R559	5240029220	2.7k Ω
R560	5240028020	820 Ω
R602, R702	5240031420	22k Ω
R802, R902	5240031420	22k Ω
R603, R703	5240032820	82k Ω
R803, R903	5240032820	82k Ω
R604, R704	5240030620	10k Ω
R804, R904	5240030620	10k Ω
R605, R705	5240030620	10k Ω
R805, R905	5240030620	10k Ω
R606, R706	5240033020	100k Ω
R806, R906	5240033020	100k Ω
R607, R707	5240034020	270k Ω
R807, R907	5240034020	270k Ω
R608, R708	5240025820	100 Ω
R808, R908	5240025820	100 Ω
R609, R709	5240031220	18k Ω
R809, R909	5240031220	18k Ω
R610, R710	5240031220	18k Ω
R810, R910	5240031220	18k Ω
R611, R711	5240027820	680 Ω
R811, R911	5240027820	680 Ω
R612, R712	5240027820	680 Ω
R812, R912	5240027820	680 Ω
R613, R713	5240031220	18k Ω
R813, R913	5240031220	18k Ω
R614, R714	5240031020	15k Ω
R814, R914	5240031020	15k Ω
R615, R715	5240033020	100k Ω
R815, R915	5240033020	100k Ω
R617, R717	5240029020	2.2k Ω

Parts marked with * require longer delivery time.

REF. NO.	PARTS NO.	DESCRIPTION
R817, R917	5240029020	2.2kΩ
R618, R718	5240031420	22kΩ
R818, R918	5240031420	22kΩ
R619, R719	5240029020	2.2kΩ
R819, R919	5240029020	2.2kΩ
R620, R720	5240031420	22kΩ
R820, R920	5240031420	22kΩ
R621	5240030620	10kΩ
R622	5240030620	10kΩ
R623, R723	5240033020	100kΩ
R624, R724	5240031420	22kΩ
R625	5240025820	100Ω
R626, R726	5240031420	22kΩ
R627, R727	5240029620	3.9kΩ
R628	5240030620	10kΩ
R629	5240030620	10kΩ
R630, R730	5240031420	22kΩ
R631	5240025820	100Ω
R632, R732	5240030620	10kΩ
R633, R733	5240033020	100kΩ
R635, R735	5240028220	1kΩ
R636, R736	5240032020	39kΩ
R836, R936	5240032020	39kΩ
R637, R737	5240032020	39kΩ
R837, R937	5240032020	39kΩ
R638, R738	5240032420	56kΩ
R639, R739	5240032020	39kΩ
R840, R940	5240032020	39kΩ
R642, R742	5240030620	10kΩ
R643, R843	5240030620	10kΩ
R644, R744	5240033020	100kΩ
R844, R944	5240033020	100kΩ
R645, R745	5240030620	10kΩ
R845, R945	5240030620	10kΩ
R646, R746	5240026820	270Ω
R846, R946	5240026820	270Ω
R648, R748	5240029520	3.6kΩ
R748, R848	5240029520	3.6kΩ
R649, R749	5240032220	47kΩ
R849, R949	5240032220	47kΩ
R650, R850	5240025820	100Ω
R651, R751	5240031420	22kΩ
R652, R752	5240031420	22kΩ
R653, R753	5240031420	22kΩ
R654, R754	5240031420	22kΩ
CAPACITORS		
C601, R701	5260212350	Elec. 10μF 16V
C801, R901	5260212350	Elec. 10μF 16V
C602, R702	5260212350	Elec. 10μF 16V
C802, C902	5260212350	Elec. 10μF 16V
C603, C703	5172204000	Ceramic 22μF 50V 10%
C803, C903	5172204000	Ceramic 22pF 50V 10%
C604, C704	5260212350	Elec. 10μF 16V
C804, C904	5260212350	Elec. 10μF 16V
C605, C705	5173433000	Ceramic 0.01μF 50V
C805, C905	5173433000	Ceramic 0.01μF 50V
C606, C706	5260214850	Elec. 100μF 16V
C806, C906	5260214850	Elec. 100μF 16V
C607, C707	5263167123	Metalized 0.022μF 50V 5%
C807, C907	5263167123	Metalized 0.022μF 50V 5%
C608, C708	5263167123	Metalized 0.022μF 50V 5%

REF. NO.	PARTS NO.	DESCRIPTION
C808, C908	5263167123	Metalized 0.022μF 50V 5%
C609, C709	5263165623	Metalized 0.0012μF 50V 5%
C809, C909	5263165623	Metalized 0.0012μF 50V 5%
C610, C710	5260212350	Elec. 10μF 16V
C810, C910	5260212350	Elec. 10μF 16V
C611, C711	5260212350	Elec. 10μF 16V
C811, C911	5260212350	Elec. 10μF 16V
C612	5260212350	Elec. 10μF 16V
C613, C713	5172212000	Ceramic 100pF 50V 10%
C614, C714	5260212350	Elec. 10μF 16V
C615	5173433000	Ceramic 0.01μF 50V
C616	5260214850	Elec. 100μF 16V
C617, C717	5260212350	Elec. 10μF 16V
C618	5260212350	Elec. 10μF 16V
C619, C719	5172212000	Ceramic 100μF 50V 10%
C620, C720	5260212350	Elec. 10μF 16V
C621	5173433000	Ceramic 0.01μF 50V
C622	5260214850	Elec. 100μF 16V
C623, C723	5260212350	Elec. 10μF 16V
C823, C923	5260212350	Elec. 10μF 16V
C624, C724	5260212350	Elec. 10μF 16V
C625, C725	5260212950	Elec. 22μF 10V
C825, C925	5260212950	Elec. 22μF 10V
C626, C726	5172212000	Ceramic 100pF 50V 10%
C826, C926	5172212000	Ceramic 100pF 50V 10%
C627, C727	5260212350	Elec. 10μF 16V
C827, C927	5260212350	Elec. 10μF 16V
C628, C728	5260213050	Elec. 22μF 16V
C828, C928	5260213050	Elec. 22μF 16V
C629, C729	5173433000	Ceramic 0.01μF 50V
C829, C929	5173433000	Ceramic 0.01μF 50V
C630, C830	5260214850	Elec. 100μF 16V
C555	5260212350	Elec. 10μF 16V
VARIABLE RESISTORS		
R61, R71	5282251200	12-Type Snap-in, 10kΩ (C)
R81, R91	5282251200	12-Type Snap-in, 10kΩ (C)
R62, R72	5282251000	12-Type Snap-in, 50kΩ (B)
R82, R92	5282251000	12-Type Snap-in, 50kΩ (B)
R63, R73	5282251000	12-Type Snap-in, 50kΩ (B)
R83, R93	5282251000	12-Type Snap-in, 50kΩ (B)
R64, R74	5282251100	12-Type Snap-in, 5kΩ (B)
R84, R94	5282251100	12-Type Snap-in, 5kΩ (B)
R65, R75	5284009300	Slide Snap-in, 50kΩ (A)
R85, R95	5284009300	Slide Snap-in, 50kΩ (A)
R66	5284009400	Slide Snap-in, 10kΩ (A) x 2
R68	5282410100	12-Type Snap-in, 10kΩ (A) x 2
R641, R741	5150094000	Semi-fixed, 50kΩ
R841, R941	5150094000	Semi-fixed, 50kΩ
CONNECTOR PLUG		
P556	5336212800	8P
SWITCHES		
S553, S554	5300911300	Slide, SSY043NS
S601, S701	5300909600	Slide, SSY023NS
S801, S901	5300909600	Slide, SSY023NS
S602	5300911200	Slide, SSY042S

REF. NO.	PARTS NO.	DESCRIPTION
MISCELLANEOUS		
	5800628300	Holder, LED
	5181761000	Jumper, P = 5
	5181765000	Jumper, P = 15
	5181763000	Jumper, P = 10
	5355102300	Wire Assy, MA

CONTROL PCB ASSY

REF. NO.	PARTS NO.	DESCRIPTION
	*5200152900	PCB Assy
	5210152900	PCB
TRANSISTORS		
Q1	5231761600	2SD1207S
	5231761700	2SD1207T
DIODE		
D2	5224013210	DS135D
CARBON RESISTORS		
All resistors are rated $\pm 5\%$ tolerance, 1/4 watt.		
R3	5181486000	1.5k Ω
R4	5181518000	33k Ω
R5	5181496000	3.9k Ω
R6, R7	5181482000	1k Ω
R8, R9	5181482000	1k Ω
R10	5181494000	3.3k Ω
CAPACITORS		
C1	5260166052	Elec. 100 μ F 16V
C2, C3	5260205500	Elec. 470 μ F 16V
C4	5173433000	Ceramic 0.01 μ F 50V
VARIABLE RESISTORS		
R1	5284008600	Slide VR 5k Ω (B)
R2	5150097000	Semi-fixed 5k Ω (B)
MISCELLANEOUS		
S1	5300031400	Switch, Push; 2-2

TAPE CUE AMPL. PCB ASSY

REF. NO.	PARTS NO.	DESCRIPTION
	*5200153200	PCB Assy
	*5210153200	PCB
IC's		
U551	5232252220	Digital Transistor; 2SC3402
U552	6048635000	NJM78L09A
U605	5220416200	M5218L
TRANSISTORS		
Q551, Q552	5230778300	2SC2320F
DIODES		
D551	5224015020	1SS133T-77
D552	5225013900	LED, SLP162B
RESISTORS		
All resistors are rated $\pm 5\%$ tolerance, 1/4 watt unless otherwise noted.		
R551, R552	5240030620	10k Ω
R553, R554	5240030620	10k Ω
R657, R757	5240032020	39k Ω
R857, R959	5240032020	39k Ω
R658, R659	5240030620	10k Ω
R660	5181458000	100 Ω
R661	5240033020	100k Ω
R662	5240032020	39k Ω
R663	5240030620	10k Ω
R664	5240031420	22k Ω
R665	5240031420	22k Ω
R666	5240033020	100k Ω
CAPACITORS		
C640, C641	5260212350	Elec. 10 μ F 16V
C642	5260212350	Elec. 10 μ F 16V
C643	5172212000	Ceramic 100pF 50V 10%
C644	5260214850	Elec. 100 μ F 16V
C645	5173433000	Ceramic 0.01 μ F 50V
C645	5172212000	Ceramic 100pF 50V 10%
VARIABLE RESISTORS		
R67, R77	5282251300	12-Type, Snap-in VR, 10k Ω (A)
R87, R97	5282251300	12-Type, Snap-in VR, 10k Ω (A)
SWITCHES		
S551	5300031400	Push, Lock; SUZ 1-key
S552	5300038000	Push, Non-lock; SUZ 1-key
MISCELLANEOUS		
	5800628300	Holder, LED
	5181763000	Jumper, P = 10
	5181761000	Jumper, P = 5
CONNECTOR PLUGS		
P551, P552	5336210400	4P
P553	5336210400	4P
P554	5336210200	2P
P555	5336210300	3P

Parts marked with * require longer delivery time.

14.

PORTA ONE

TASCAM
TEAC Professional Division

TEAC CORPORATION

3-7-3 NAKA-CHO MUSASHINO TOKYO PHONE (0422) 53-1111

TEAC CORPORATION OF AMERICA

7733 TELEGRAPH ROAD MONTEBELLO CALIFORNIA 90640 PHONE (213) 726-0303

TEAC CANADA LTD.

3610 NASHUA DRIVE UNIT 1 & 2 MISSISSAUGA ONTARIO L4V 1L2 PHONE 416-673-3303

TEAC AUSTRALIA PTY., LTD.

115 WHITEMAN STREET SOUTH MELBOURNE VICTORIA 3205 PHONE 699-6000

PRINTED IN JAPAN 1284SK · D-4746A