

EPA-100 for Technics SL-1000MKII

Variable Dynamic Damping Universal Tonearm with
Ruby Ball Bearings

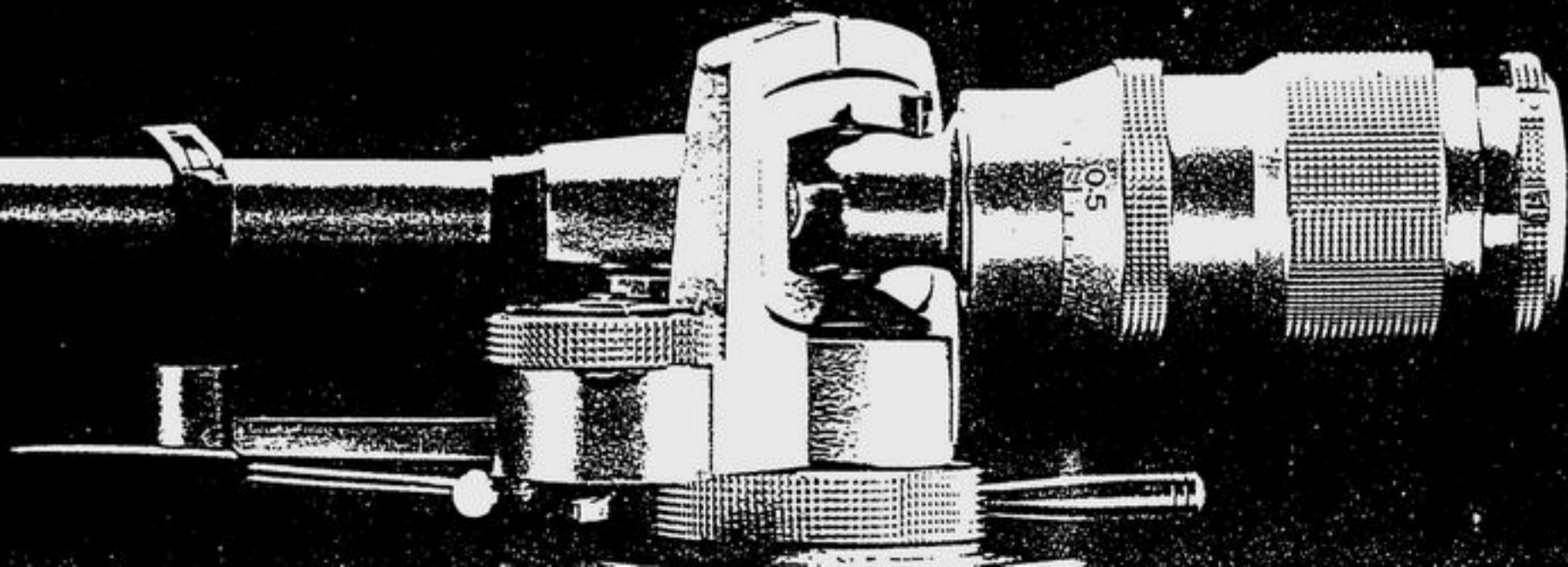

Parts identification

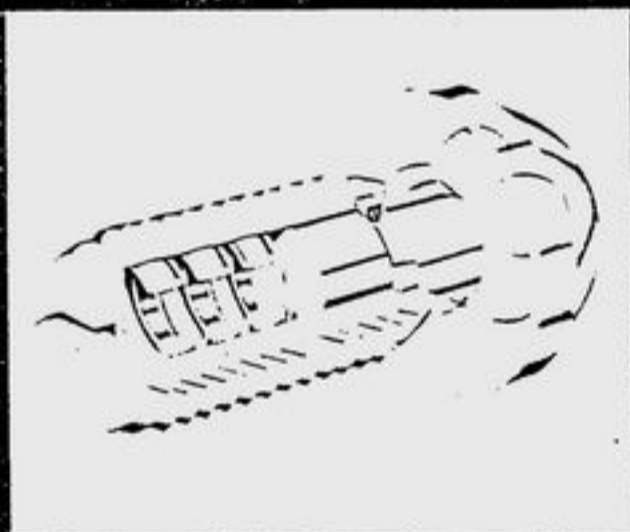
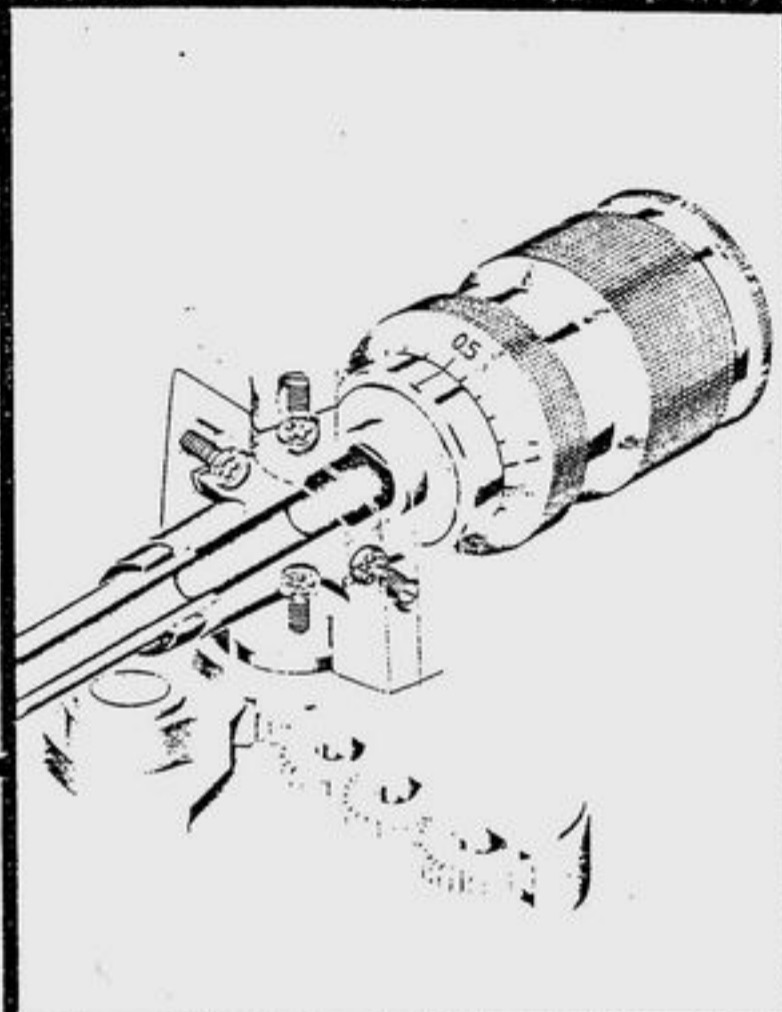
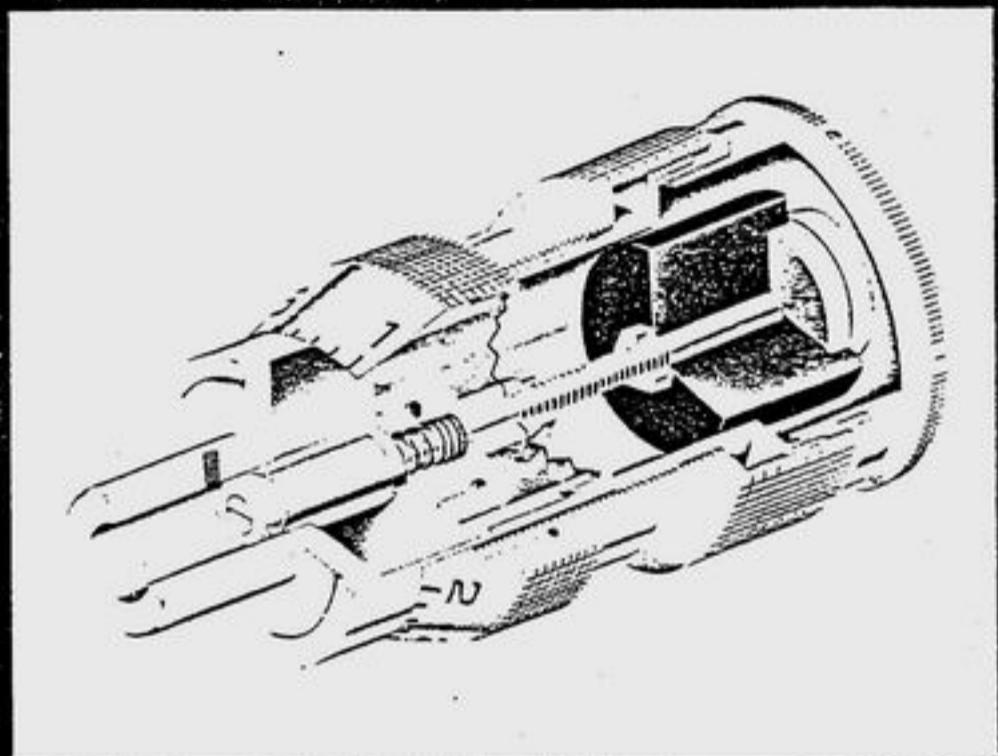
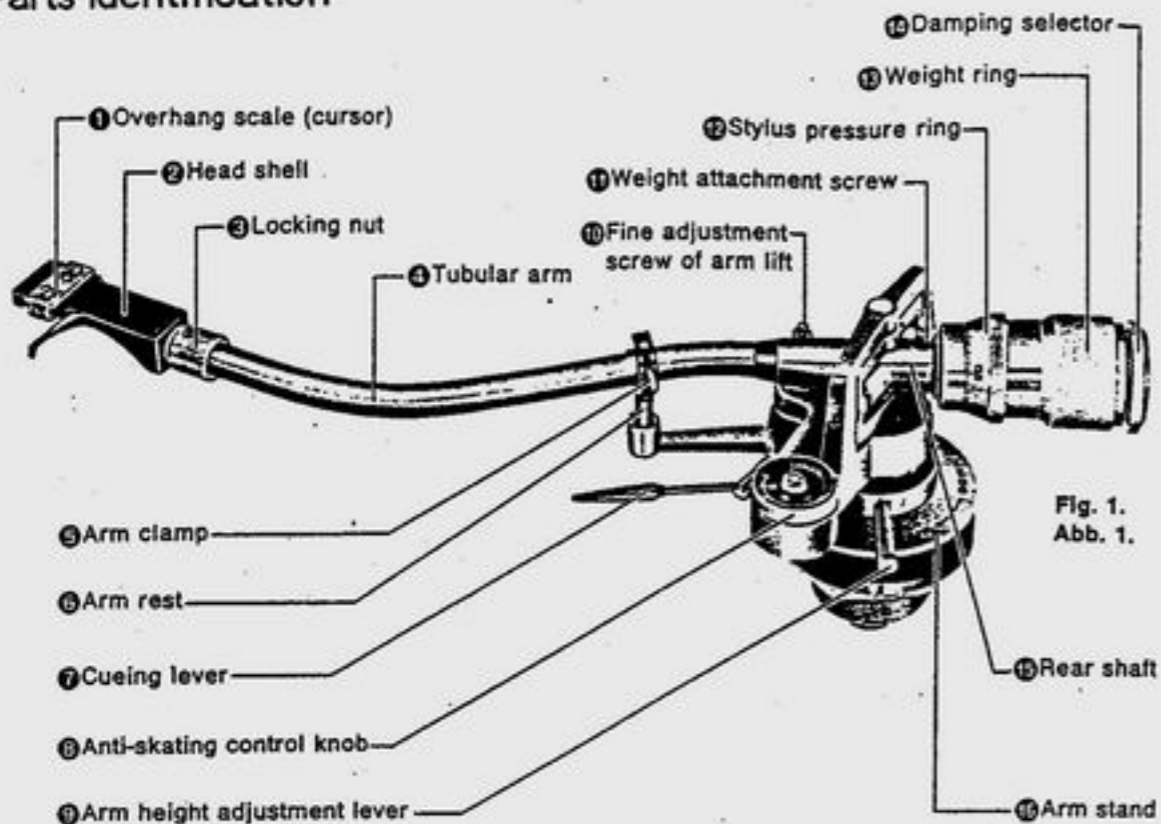

Fig. 1.
Abb. 1.

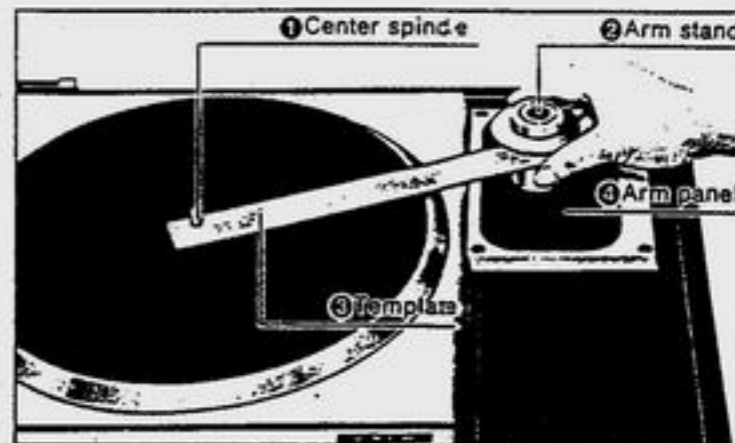

Fig. 2
Abb. 2



Fig. 3
Abb. 3

We want to thank you for selecting the EPA-100 Variable Dynamic Damping Universal Tonearm.

The EPA-100 can be adjusted to the optimum damping amount corresponding to the compliance of the cartridge used. This tonearm has many important features to assure you of excellent performance. Among these are our original Dynamic Damping System, the highly sensitive gimbal-suspension system with 20 rubies for high precision, and the lightweight titanic arm with its high-strength hardening treatment using a special nitrification method. This tonearm is an excellent example of the total concentration of technology—a universal tonearm with superb high performance characteristics.

In order to obtain the finest performance of the many features of this tonearm, and to assure longer and most satisfying service, please be sure to read these operation instructions carefully before use.

Check of parts

After opening the box in which this unit is packed, check all of the included component parts

Tonearm unit	1
Balance weight with mounting screw	1
Head shell	1
Arm stand	1
Rubber "cushions"	2
Nut	1
Washer	1
Phono output cable	1
Screwdriver	1
Wrench	1
Screws for cartridge (long)	2
Screws for cartridge (short)	2
Nuts for cartridge	4
Template	1

Note:

The bearing part of this tonearm features a very delicate construction including 20 rubies. In order, therefore, to avoid damage from impact or transportation handling, the tonearm itself, the balance weight, and the tonearm base are each packed separately.

English	Page	1-14
Deutsch	Seite	15-31
Français	Page	32-48
Nederlands	Bladzijde	49-65
Svenska	Sidan	66-80
Español	Página	81-97

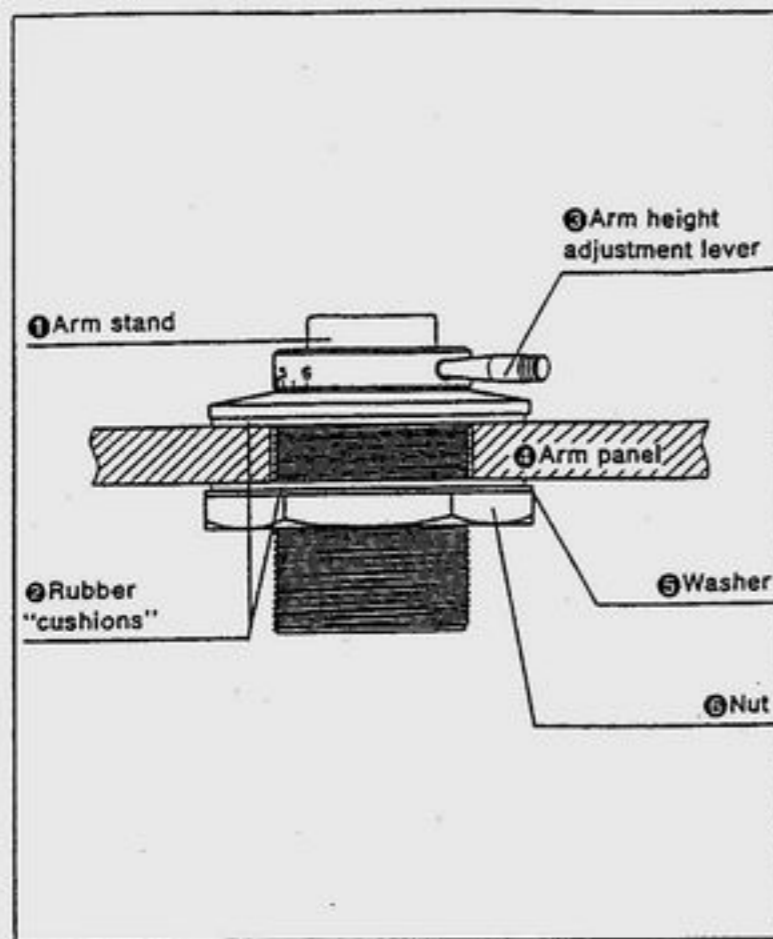

Fig. 4
Abb. 4



Fig. 5
Abb. 5

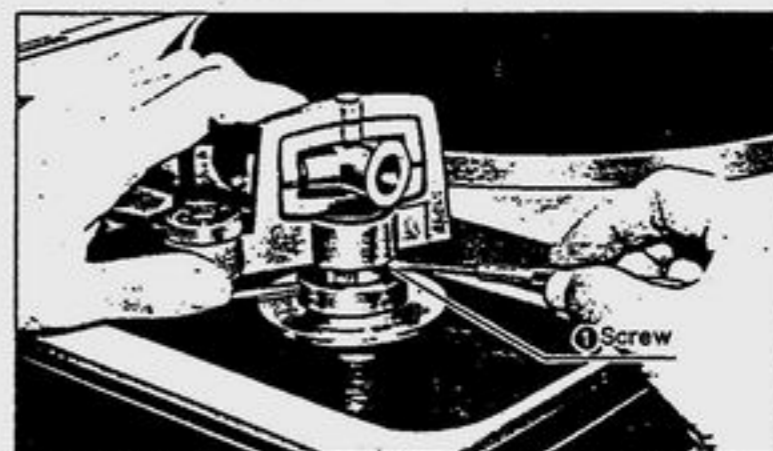

Fig. 6
Abb. 6

Assembly and set-up

1 Tonearm installation position

For the Technics SL-1000MKII Direct Drive Turntable System, the hole for the EPA-100 has already been prepared. Begin, therefore, from step (3).

- (1) Place the template (included) over the center spindle. Then, holding the arm stand as shown in Fig. 2, determine where the tonearm will be installed. While moving the arm stand, determine the proper position, and mark a circle at this position with a pencil.

Note:

Be sure to check the tonearm position in order to determine whether the back part of the tonearm will contact the dust cover when a record is played.

- (2) Make a hole (38 mmø) in the arm panel (Fig. 3). Using a hand drill or similar tool, make holes, as shown in the figure, along the round mark made in item (1). Then cut away any unnecessary parts, and finish the hole by using a round file.

- (3) Attach the arm stand to the arm panel, and tighten completely by using the included wrench (Fig. 4).

Note:

In order to make later adjustment of the height of the tonearm easier, move the lever for fine adjustment of arm height to the right (Fig. 5).

- (4) Pull out the phono output cable from the underside of the turntable base and pass it through the inside of the arm stand (Fig. 5).
- (5) Then align the groove of the tonearm connector with the projection of the plug, and connect by inserting all the way in until the plug stops.
- (6) Attach the tonearm to the arm stand, and temporarily set the height of the tonearm by tightening the tonearm holding screws (using the included screwdriver) (Fig. 6).

Note:

For tightening the holding screw for securing the arm, please perform this when the height gauge is in position "6." In the case of model SH-10B3, install the tonearm up to the point where it stops.

2 Installation of cartridge and head shell

The cartridge can be installed by referring to the operation instructions for the 205C-II type cartridge.

If any other cartridge is to be installed, refer to the operation instructions of that cartridge.

- (1) Connect the lead wires to the cartridge.

The terminals of most cartridges are color coded. Connect each lead wire to the terminal of the same color.

Red → R + (right channel, (+) terminal)

Green → R - (right channel, ground terminal)

White → L + (left channel, (+) terminal)

Blue → L - (left channel, ground terminal)

- (2) Temporarily attach the cartridge to the head shell by using the included screws (Fig. 7).

Note:

To prevent damage to the stylus tip, it should be removed from the cartridge, or should be covered, while lead wires are being connected, and while the cartridge is being attached to the head shell.

- (3) Make adjustment of the overhang (Figs. 8 and 9). The head shell has a special cursor which can be used to easily make the adjustment of the overhang.

Depending upon the dimensions specified for the cartridge which is to be used, determine the distance (in millimeters) from the position of the screws to the stylus tip; and then align the index line mark on the head shell with the calibrated mark (on the cursor) which is the same numerical value.

The distance from the position of the screws to the stylus tip of the 205C-II type cartridge is 9.0 mm. (Refer to Fig. 9.)

Note:

When the cartridge is attached, visually check to be sure, looking both from the side and the front, that the cartridge is on the same horizontal plane as (i.e., is parallel to) the surface of the record, and that the central axis of the cartridge and of the head shell are in line with each other (Fig. 10).

- (4) Attach the head shell to the tonearm (Fig. 11).

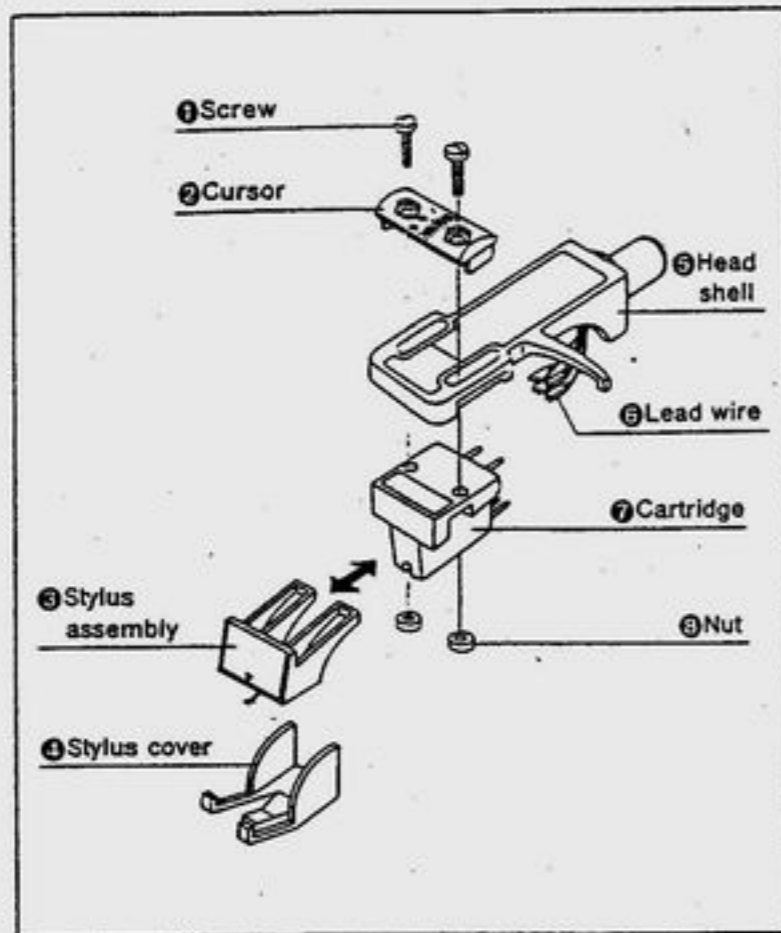

Fig. 7
 Abb. 7

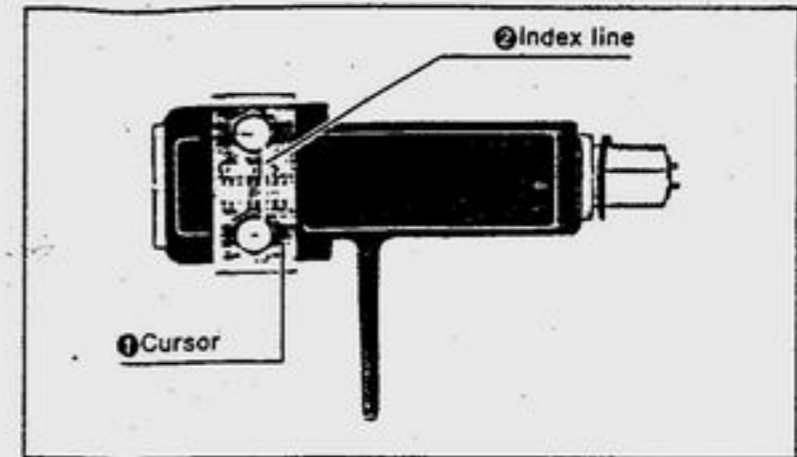

Fig. 8
 Abb. 8

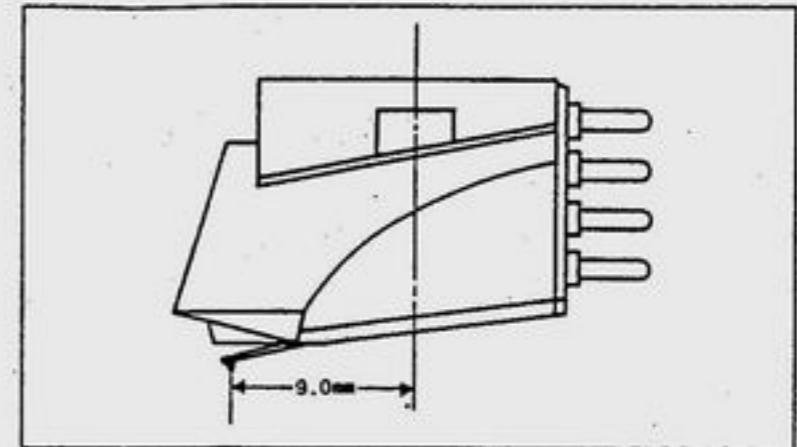

Fig. 9
 Abb. 9

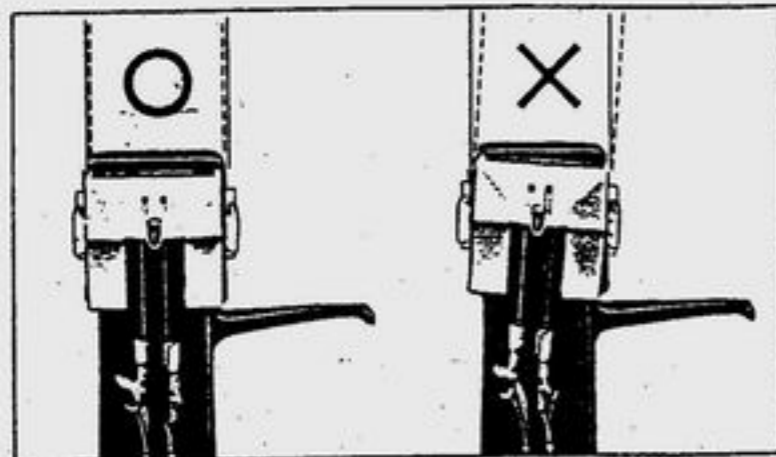

Fig. 10
 Abb. 10

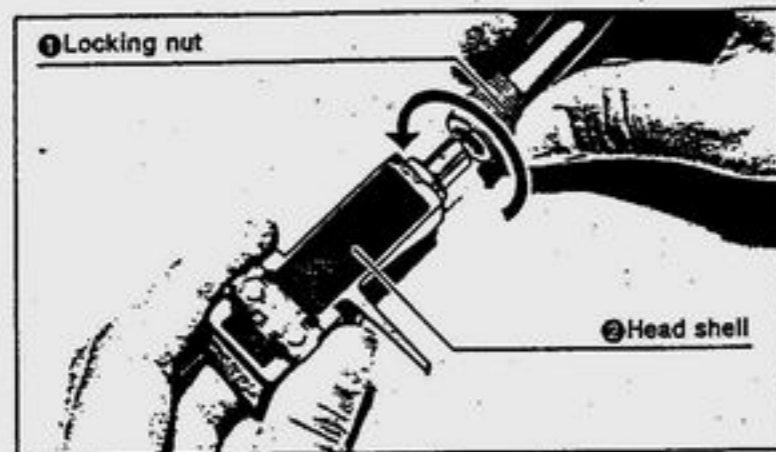

Fig. 11
 Abb. 11

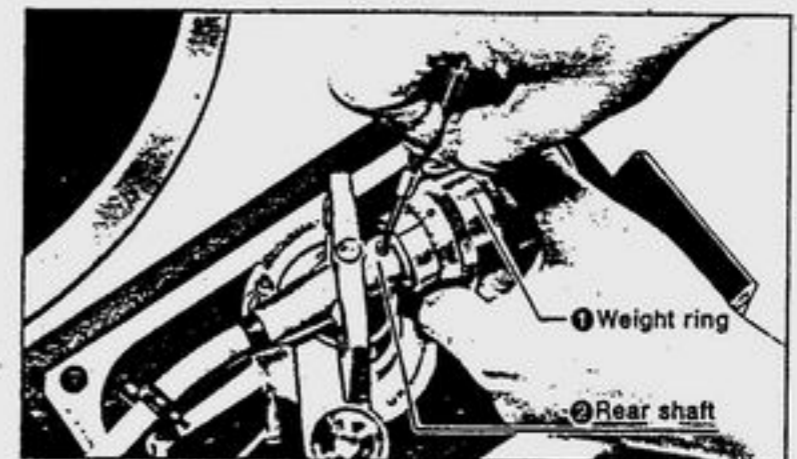

Fig. 12
 Abb. 12



Fig. 14
 Abb. 14



Fig. 15
Abb. 15

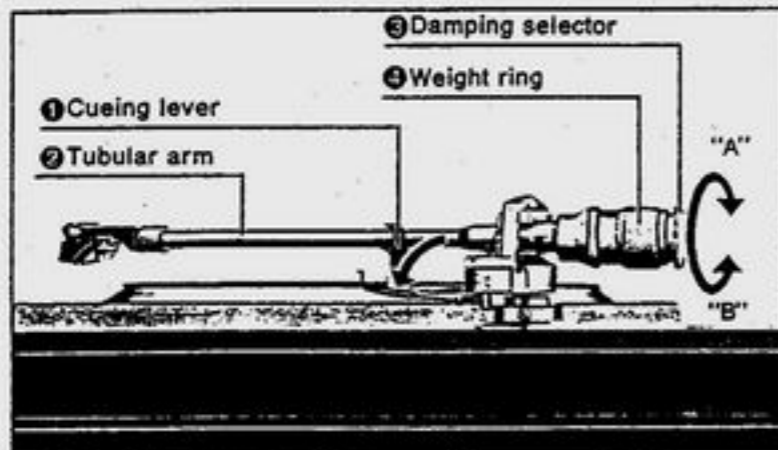

Fig. 16
Abb. 16



Fig. 17
Abb. 17

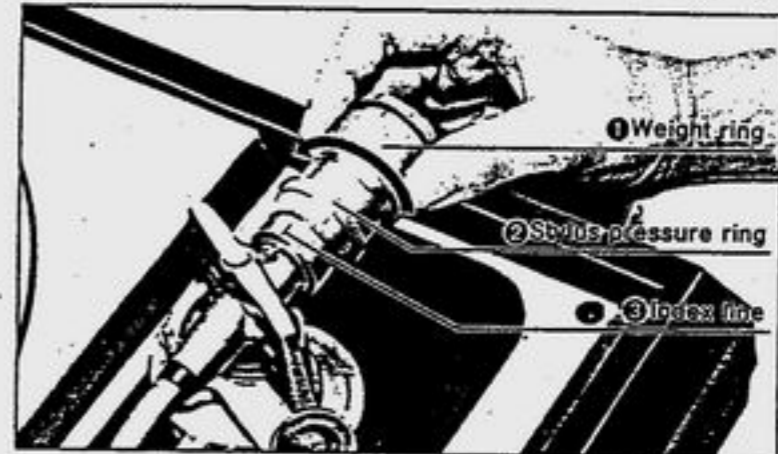

Fig. 18
Abb. 18

③ Installation of the balance weight

Place the balance weight onto the rear shaft of the tonearm, align the hole for the screw, and tighten the screw completely (Fig. 12).

④ Adjustment of the damping selector

This tonearm includes a unique magnetic damping selector which can be used to assure that the tonearm is perfectly matched to the compliance of the cartridge to be used.

The damping selector is calibrated in five positions, (1~5), and the position which corresponds to the compliance and weight of the cartridge should be aligned with the index mark on the balance weight. (Refer to the chart of Fig. 13 and see Fig. 14.)

The following are the standards of applicable calibrations depending upon the compliance of the cartridge to be used. For precision, also refer to feature ①.

Damping selector calibrations	Cartridge compliance (100 Hz dynamic)
4~5	more than 15×10^{-6} cm/dyne
2~4	$10 \sim 15 \times 10^{-6}$ cm/dyne
1~2	$5 \sim 10 \times 10^{-6}$ cm/dyne

Fig. 13

In the case of the 205C-II type cartridge, because the compliance is 12×10^{-6} cm/dyne, and the weight is 6.5 g, the [3.5] setting should, therefore, be used.

Note that the damping selector position is continuously variable, and any position between the calibrations can therefore also be selected.

Note:

If the damping selector is rotated completely in the direction of the [1] mark, the movable weight inside the balance weight will become locked, and the tonearm can be used as an ordinary high-sensitivity tonearm, without dynamic damping.

When the unit is moved, be sure to rotate the damping selector completely to the [1] mark in order to lock and protect the internal structure of the balance weight.

Adjustment of parts

① Adjustment of the "0" balance

Before making the adjustment of horizontal balance, check the following points:

- (1) Check whether the cueing lever is in the down position or not.
- (2) Check whether the anti-skating control is set to the "0" position or not.
Although the tonearm may move very slightly to the left and right when the anti-skating control is set to the "0" position, this is because of the high sensitivity of the rotating part of the tonearm, and is no problem, because the lateral force is very small.
- (3) If the cartridge to be used has a removable cover, remove it.

② Adjustment of horizontal (zero) balance and of stylus pressure

- (1) Remove the arm clamp, and move the tonearm away from the arm rest so that it is freely suspended (Fig. 15).
- (2) While turning the weight ring in direction "A" or "B" (as indicated by the arrows), adjust so that the tonearm is as horizontal as possible (Fig. 16).
Do not touch the damping selector while making this adjustment.
- (3) After finishing the adjustment of the horizontal balance, return the tonearm to the arm rest, and secure it with the arm clamp.
- (4) As shown in the figure, hold the weight ring with a finger so that it does not move, and turn only the stylus pressure ring so that the "0" indication of the ring is aligned with the index mark on the weight (Fig. 17).

Note:

When the horizontal balance is adjusted, be careful that the stylus tip of the cartridge does not touch the turntable mat or the turntable base.



Fig. 19
Abb. 19



Fig. 20
Abb. 20

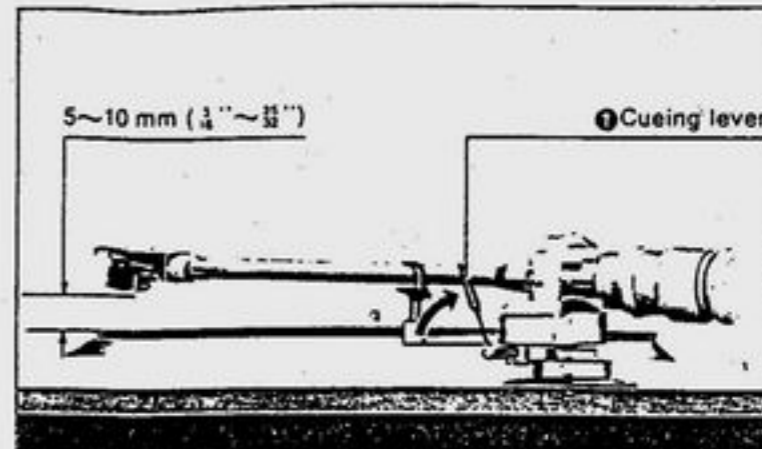

Fig. 21
Abb. 21



Fig. 22
Abb. 22

- (5) Next turn the weight ring, and set it to the numerical value corresponding to the rated stylus pressure of the cartridge to be used (Fig. 18).
Because the stylus pressure ring also moves when the weight ring is turned, the calibration can be read directly, thus making it easy to correctly adjust the stylus pressure.
- (6) Turn the anti-skating control, and set it to the same numerical value as the stylus pressure (Fig. 19).

⑥ Adjustment of arm height and confirmation of arm movement range

- (1) Place a record on the turntable, and, without rotating the turntable, gently place the stylus tip on the record.
- (2) While turning the arm height adjustment lever to the "DOWN" position, adjust the tubular arm until it is nearly parallel with the record surface. (See Fig. 20.)
The arm height adjustment can be fine adjusted in 0.5 mm steps over a range of 6 mm.

Note:

If the fine adjustment of the height adjustment can not be made, turn the fine adjustment height lever in the "UP" direction to "6," loosen the securing screws, and slightly raise the tonearm. Afterward, re-adjust the fine adjustment.

⑦ Adjustment of arm lift distance

The arm lift distance (the space between the stylus tip and the record surface when the cueing lever is raised as shown in the figure) is most suitable at about 5~10 mm. Adjust, if necessary, so that the distance will be within this range (Fig. 21).

- (1) Raise the cueing lever.
- (2) To make the adjustment, first loosen the lock nut and then turn the screw for fine adjustment of the arm lift (Fig. 22).
After adjustment, re-tighten the lock nut.

Clockwise

The distance between the stylus tip and the record surface will increase.

Counterclockwise

The distance between the stylus tip and the record surface will decrease.

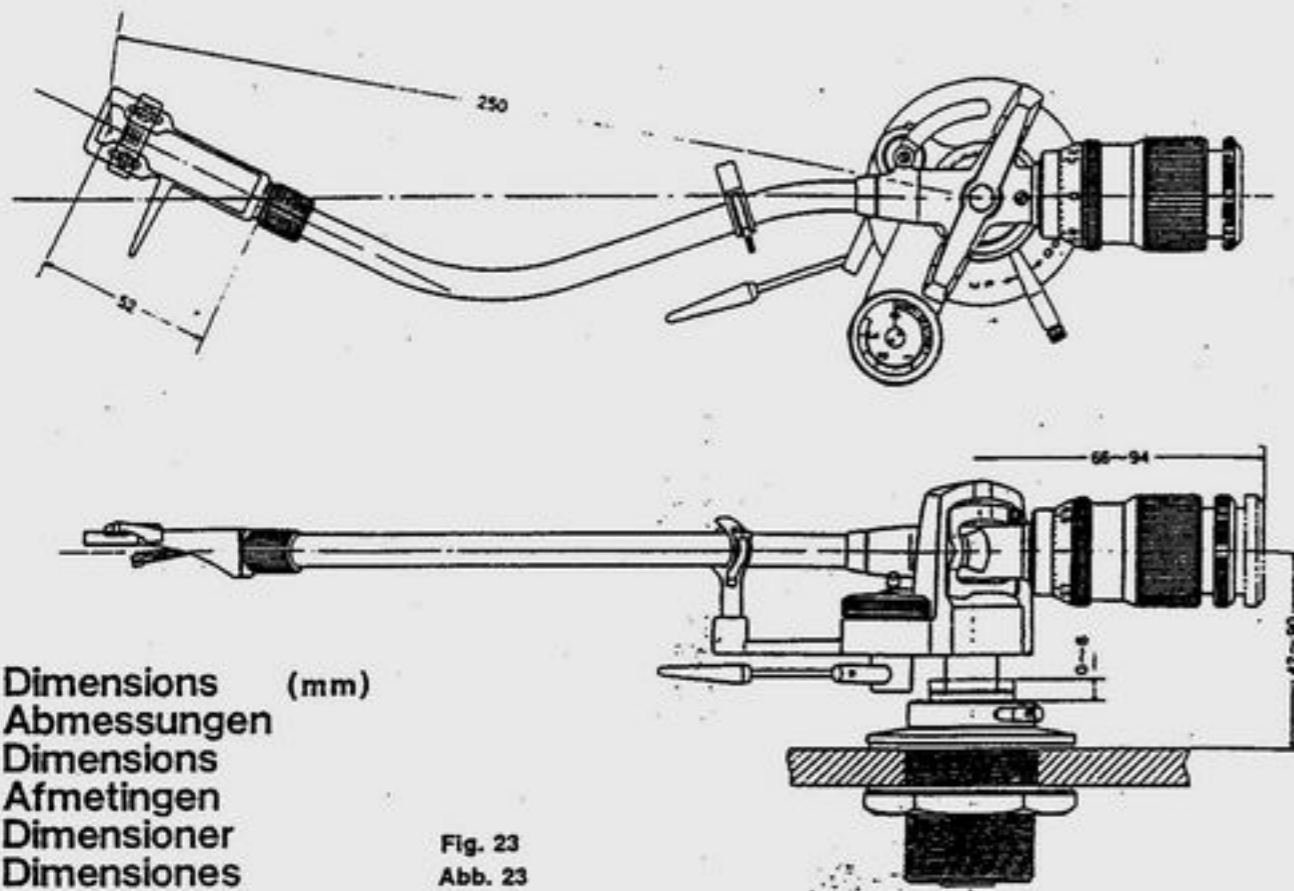

Dimensions (mm)
 Abmessungen
 Dimensionen
 Dimensioner
 Dimensiones

Fig. 23
 Abb. 23

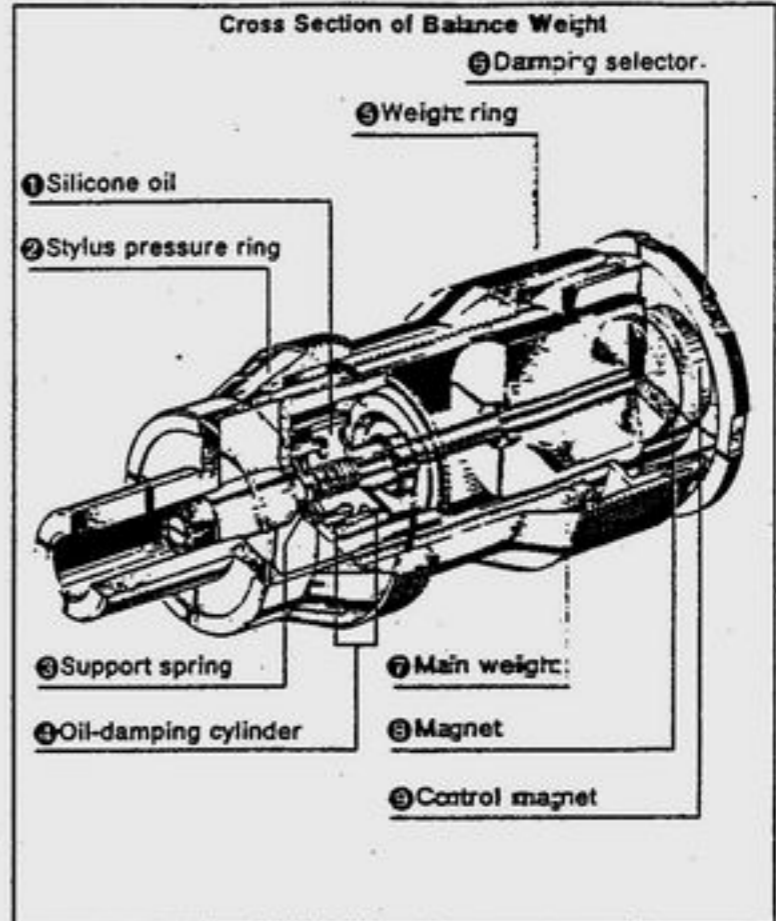

Fig. 24
 Abb. 24

Connection of phono output cable

PHONO terminal	Amplifier
White (L)	→ to PHONO L input terminal
Red (R)	→ to PHONO R input terminal
Black (ground)	→ to GND terminal

Note:
 Be sure to connect the ground wire. If no ground connection is made, a "hum" noise will be heard.

Specifications

Type Universal Tonearm with Variable Dynamic Damping system

Bearings Gimbal-suspension system with shock-resistant pivot and coil spring, and highly precise ruby ball bearings (20)

Tubular tonearm High-strength titanium tubular tonearm with special nitidification finish

Effective length 250 mm

Overall range 322~350 mm

Arm rear range 66~94 mm

Height adjustment range..... 42~90 mm (helicoid part: 6 mm)

Overhang 15 mm

Horizontal tracking error angle +1.1° (internal perimeter of 30 cm record)
 +2.1° (external perimeter of 30 cm record)

Friction 5 mg. (horizontally and vertically)

Effective mass 22 g. (at 6.5 g. cartridge weight, 1.25 g. stylus pressure)

Resonance frequency 9.8 Hz (at 6.5 g. cartridge weight, 1.25 stylus pressure 12×10^{-4} cm/dyne compliance)

Resonance acute angle (Q) 6 dB or less (at optimum adjustment)

Damping adjustment range

Damping selector calibrations	Cartridge compliance (100 Hz dynamic)
4~5	more than 15×10^{-4} cm/dyne
2~4	$10 \sim 15 \times 10^{-4}$ cm/dyne
1~2	$5 \sim 10 \times 10^{-4}$ cm/dyne

Adjustable Range of Damping Selector in Accordance with Cartridge Compliance

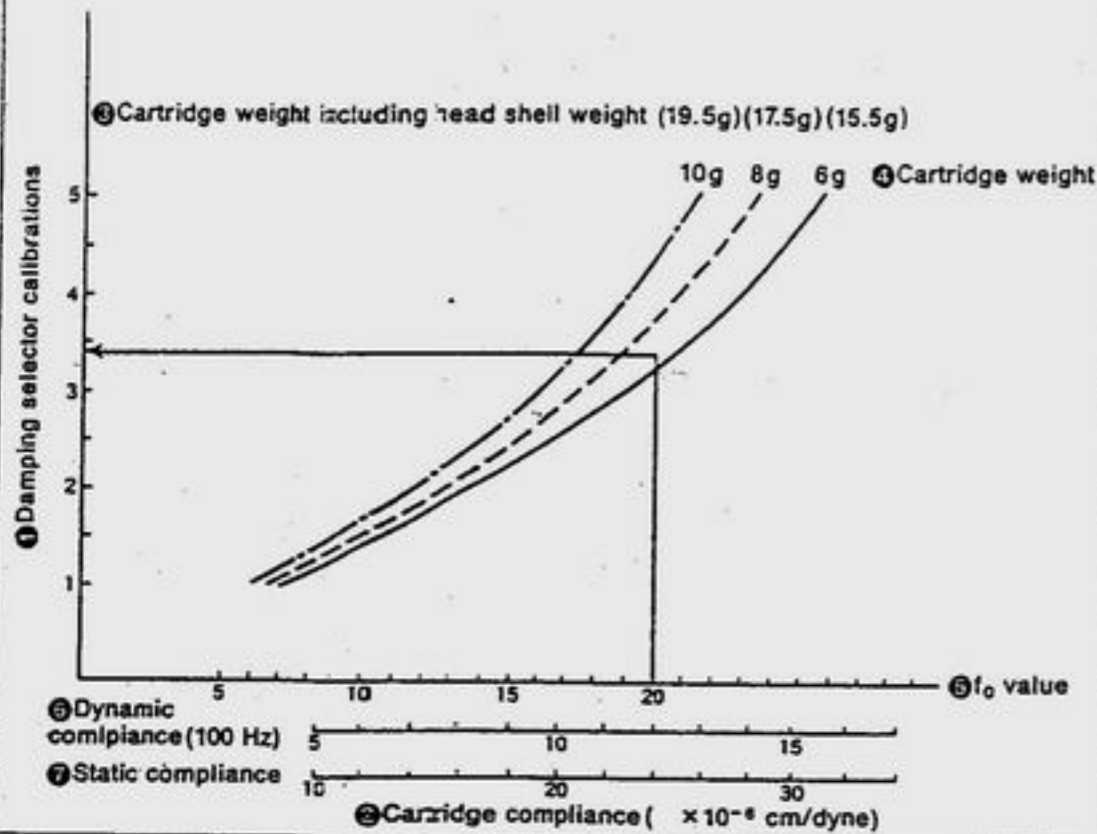

Fig. 25
Abb. 25

Comparison of Frequency Response at Low Frequency Range

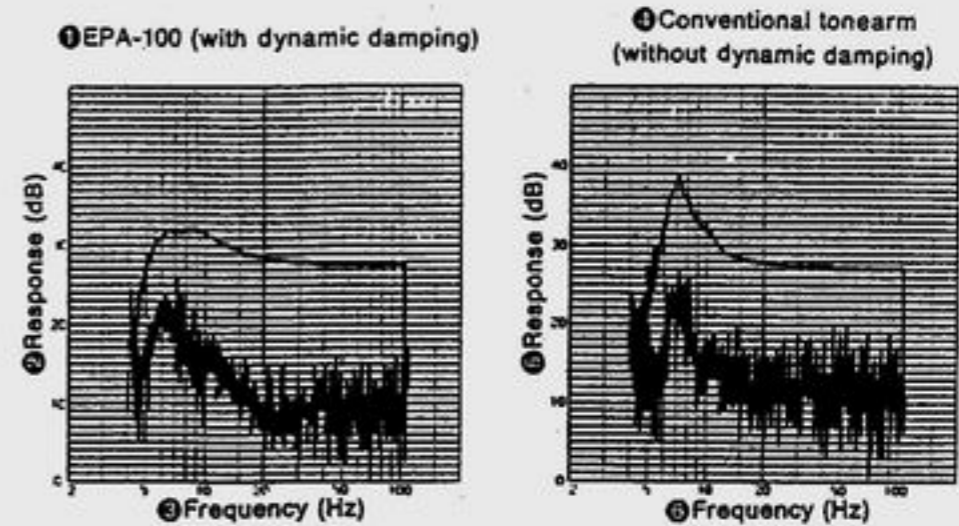

Fig. 26
Abb. 26

Stylus pressure adjustment

range0~3 g.

Head shell weight.....9.5 g.

Cartridge mounting

dimensions12.7 mm (1/2 inch) mounting space

Head shell terminal lug1.25, for 4-pin terminal

Cartridge weight range5~10 g.

Arm installation opening.....38 mm

Features

① Unique computer-designed dynamic damping system

This unit has been precisely designed on the basis of data compiled from the analysis of tonearm dynamic characteristics by computers. The balance weight, which is the heart of this system, incorporates a precise damping mechanism which can be used for adjustment to the optimum degree of damping in relation to the sub-sonic resonance determined by the equivalent mass of the cartridge and the compliance (Figs. 24 and 25).

As shown in the figure, the movable weight is separated according to the compliance of the spring, and is damped by a viscous fluid (silicone oil), thus forming the dynamic resonator. In addition, this system has low mechanical impedance and a magnetic damping adjustment mechanism whereby the resonant frequency of the movable weight part can be adjusted by the two magnets, yielding a low resonant characteristic (Q). With this unique damping system, therefore, intermodulation distortion in the low frequencies, as well as ultra-low-range noise, are reduced, making possible reproduction with a high signal-to-noise ratio. Finally, performance with respect to both external oscillation and "howling" prevention has been remarkably improved (Figs. 26 and 27).

Damping selector settings and cartridge compliance

- (1) The values shown are applicable when the included head shell (weight: 9.5 g.) is used. If, therefore, a different head shell is used, use a value which is the sum of the weight of the cartridge itself plus the weight of the head shell.
- (2) Although cartridges which have a large compliance and which are heavy are not within the adjustment range, the adjustment deviation is extremely minor, and therefore the damping selector should be set to the "5" position.
- (3) The cartridge compliance values shown here are based upon a resonance frequency value of f_0 . Select, therefore, the approximate value by locating the column in which the indication of the cartridge to be used is shown.

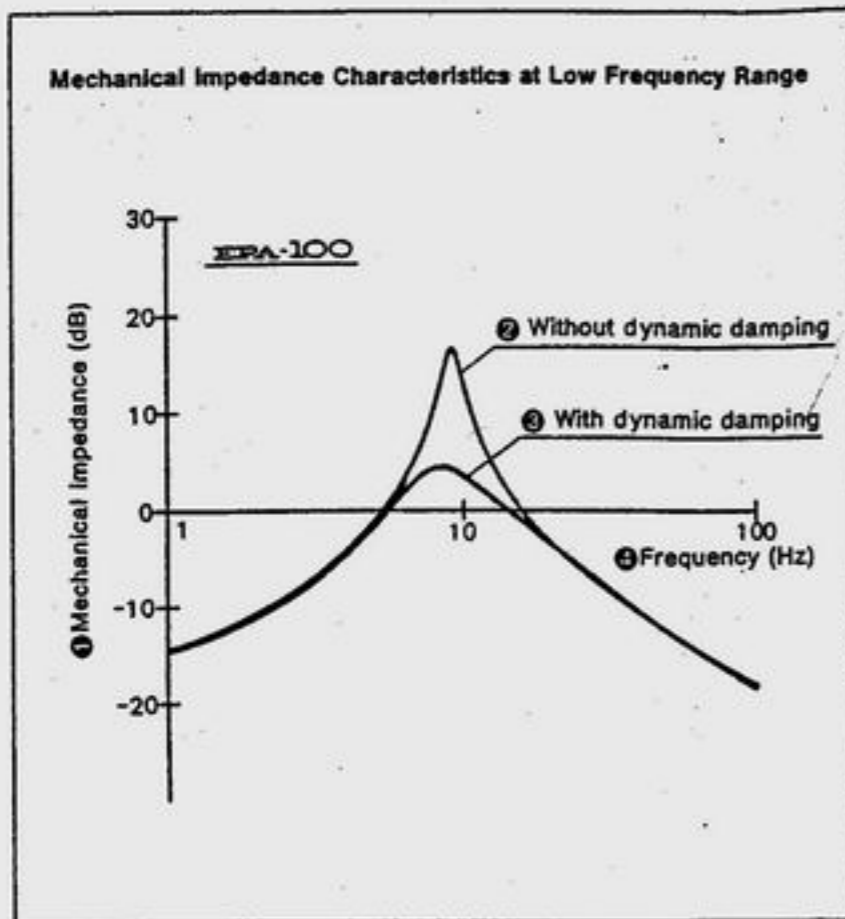

Fig. 27
Abb. 27

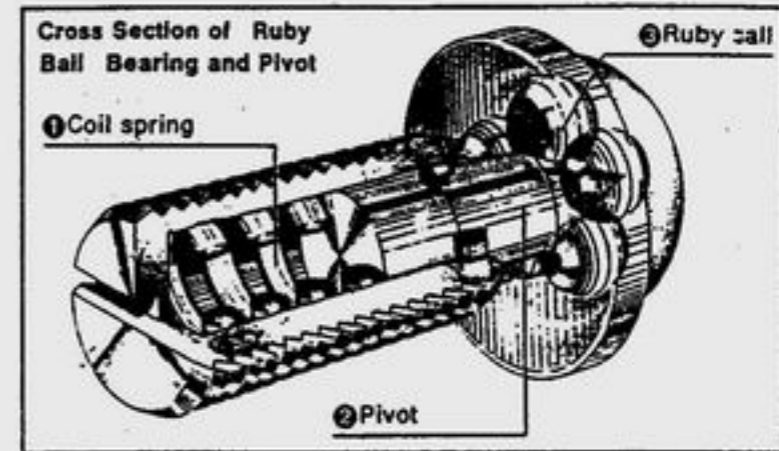

Fig. 28
Abb. 28



Fig. 29
Abb. 29

- ② Highly sensitive gimbal-suspension bearing system with special pivot, and 20 high-precision, low-friction rubies (Figs. 28, 29 and 30)

A highly precise ball bearing system consisting of 5 ruby ball bearings finished to a high degree of accuracy ($\pm 0.5 \mu$ diametral precision) is used in each horizontal/vertical bearing of the tonearm. The special construction of the bearings eliminates such disadvantages as reduced sensitivity and tilting of the cartridge which have been problems with conventional one-point-support, oil-damped tonearms (increasing the mechanical impedance), thus resulting in an initial sensitivity of 5 mg., and demonstrating superb tracking performance.

In addition, the pivot shaft features an impact-shockproof construction, made possible by the use of a floating pivot, thus reducing the effect of impacts on the ruby ball bearings and the pivot.

Because the lateral and vertical adjustment axes are long (30 mm), there is very little tracking error by the installed cartridge.

- ③ Lightweight titanium tubular tonearm treated by special nitrification process for high-strength hardening (Figs. 31 and 32)
- Titanium is a metal which is both light in weight and high in mechanical strength. Originally developed for space vehicles, this metal is here used in a tonearm for the first time in the world. This tubular tonearm of titanium has an outer diameter of 9.5 mm, and a material thickness of 0.5 mm, making it lighter in weight (85%) than ordinary aluminum tubular tonearms. In addition, a special nitrification treatment is used on the titanium tubular tonearm, which has a large internal loss, thus increasing the mechanical strength (about 1.6 times stronger). The result is a tonearm with a light effective mass and with greatly reduced partial resonance caused by bending and torsion of the tubular tonearm.

- ④ Lightweight aluminum die-cast head shell for vibration-proof performance (Fig. 33)

The lightweight head shell is die-cast of an aluminum alloy for superior vibration-proof performance. It is designed primarily for high strength, and a special vibration-proof viscous elastic material is used in order to assure completely non-resonant performance.

The head shell also includes a special cursor device which can be conveniently used for easy adjustment of the overhang.

- ⑤ Straight-hellicoid-type stylus pressure adjustment mechanism assures adjustment of stylus pressure as precise as 0.05 gram.

- ⑥ Hellicoid-type arm-height adjustment mechanism can be used to make adjustments during operation.

- ⑦ Unique anti-skating control is easy to operate for accurate negation control of skating force.

- ⑧ Arm rest has special arm-clamp mechanism using steel ball.

- ⑨ Phono output cable is special low-capacity type designed to prevent influence of high-range characteristics of the cartridge.

- ⑩ Precise processing and finishing appropriate to a tonearm of the finest quality

Every component part of this fine tonearm has been as precisely processed as the parts of the finest camera. Each single component is carefully assembled and adjusted with rigid precision, thus assuring completely accurate operation and, needless to say, convenient operation.

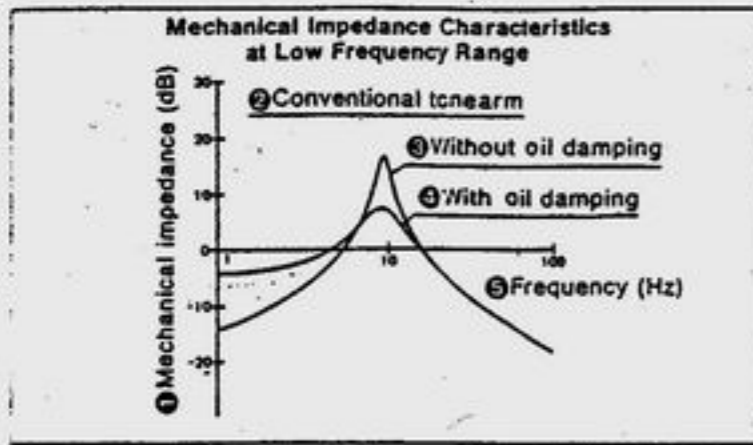

Fig. 30
Abb. 30

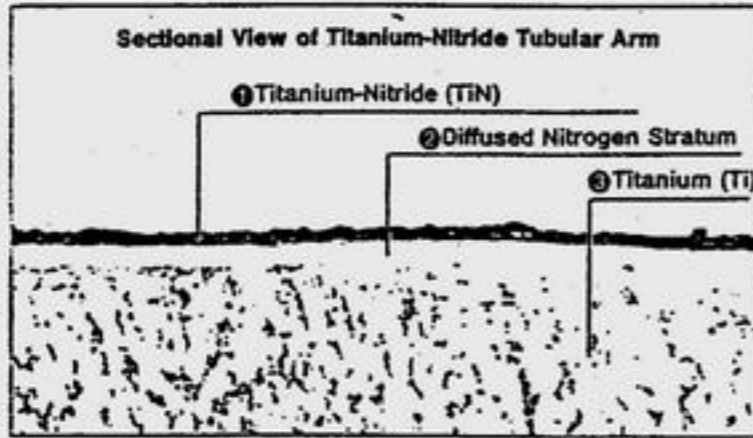

Fig. 31
Abb. 31

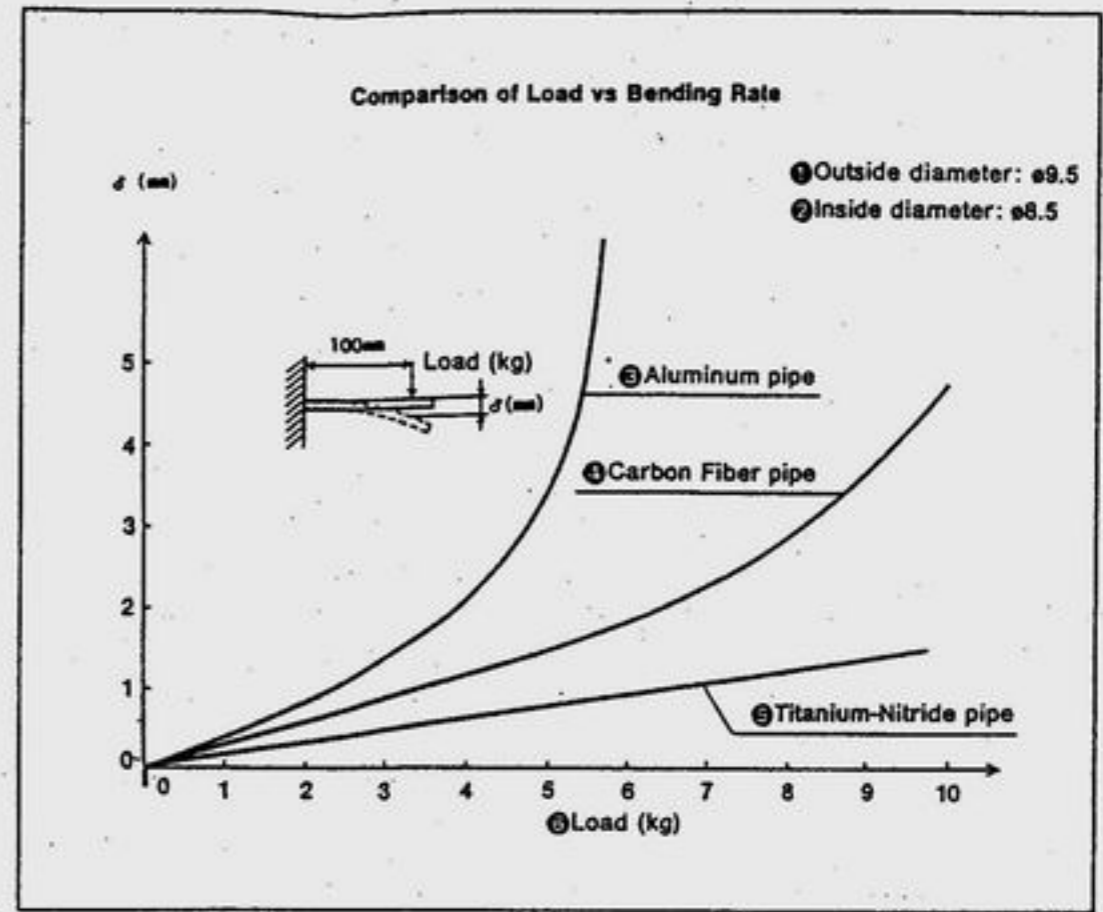

Fig. 32
Abb. 32

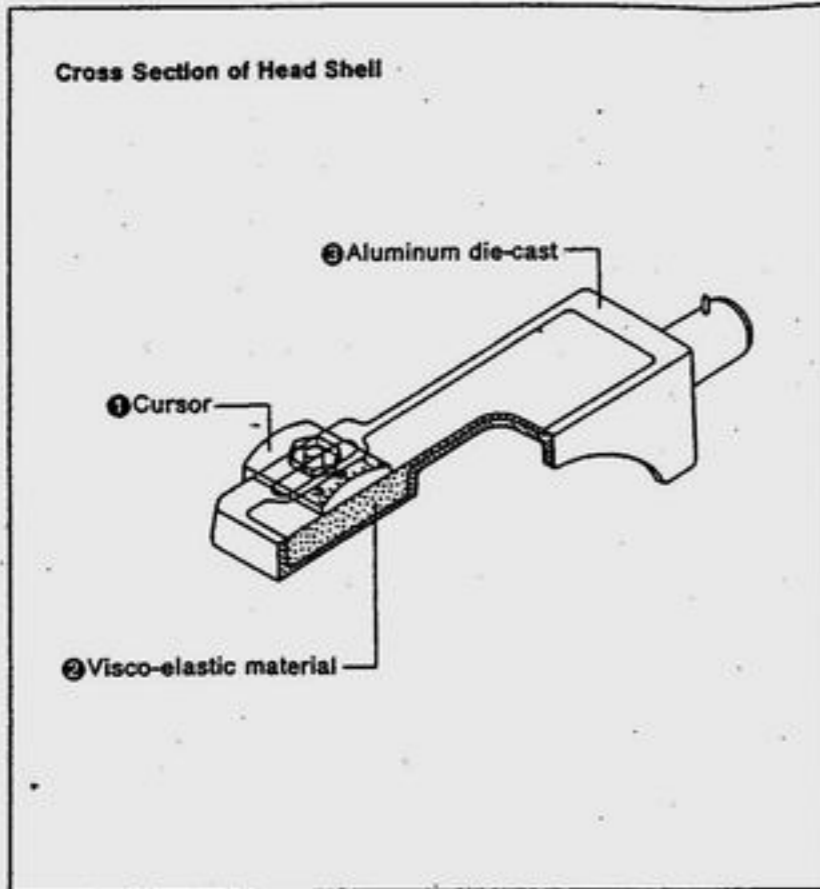

Fig. 33
Abb. 33