

Service Manual

Cassette Deck
RS-616

Front-Loading Vertical Hold High Fidelity Stereo
Cassette Deck with Rewind Auto Play System



RS-631 MECHANISM SERIES

Specifications (Catalog specifications for sales)

Power requirement:	AC; 110/125/220/240V, 50/60Hz	Fast forward and	
	Preset power voltage; 220V for Europe, 125V for Asia	rewind time:	Approx. 90 seconds with C-60 cassette tape
	Power consumption; 10W	Input:	MIC; sensitivity 0.25mV, input impedance 10K Ω , applicable microphone impedance 400 Ω ~10K Ω
Motor:	Electronic control DC motor	Output:	LINE; sensitivity 60mV, input impedance 56K Ω
Track system:	4-track 2-channel stereo recording and playback		LINE; output level 420mV, load impedance 22K Ω over
Tape speed:	4.8 cm/s (1-7/8 ips.)	Rec/pb connection:	5 P DIN type; input level 8mV, impedance 5.6K Ω , output level 420mV, impedance 1K Ω
Wow and flutter:	0.07% (WRMS), 0.2% (DIN)	Bias frequency:	90kHz
Frequency response:	CrO ₂ /FeCr tape; 30 ~ 16,000Hz	Head:	2-head system
	30 ~ 14,000Hz (DIN)		1-LH head for record/playback
	Normal tape; 30 ~ 14,000Hz		1-double-gap ferrite head for erasure
	30 ~ 13,000Hz (DIN)	Dimensions:	46 cm(W) \times 15 cm(H) \times 27.1 cm(D)
Signal-to-noise ratio:	Dolby* NR in; 66 dB (above 5kHz)		[18"(W) \times 6"(H) \times 10-3/4"(D)]
	Dolby NR out; 56 dB	Weight:	5.2kg (11 lbs 8 oz)
	(signal level = max. recording level, FeCr or CrO ₂ type tape)		

Specifications are subject to change without notice.

* 'Dolby' and the double-D symbol are trademarks of Dolby Laboratories.

Technics

Panasonic Tokyo
Matsushita Electric Industrial Co., Ltd.
17-15, 6-chome, Shinbashi, Minato-ku, Tokyo 105 Japan

Matsushita Electric Trading Co., Ltd.
P.O. Box 288, Central Osaka Japan

LOCATION OF CONTROLS AND COMPONENTS

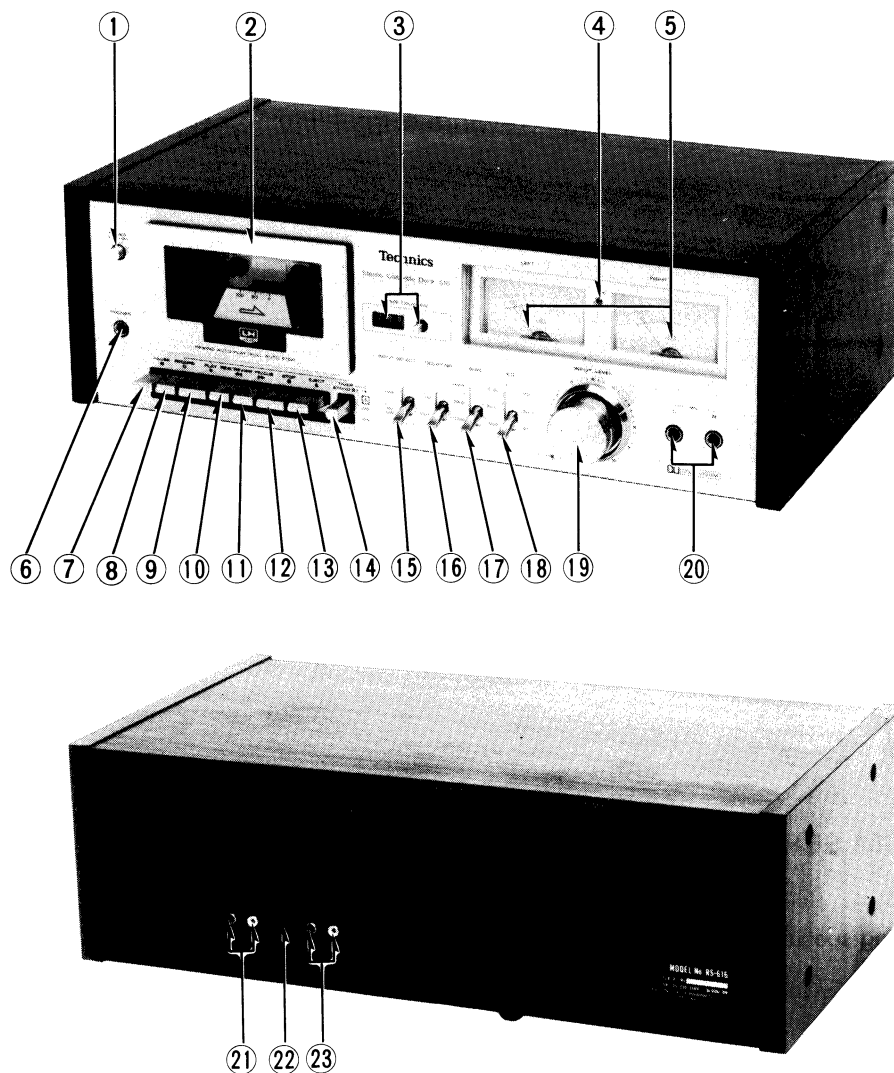

Fig. 1

- | | |
|---------------------------------|-------------------------------------|
| ① Power switch | ⑬ Eject button |
| ② Cassette compartment door | ⑭ Timer stand-by button |
| ③ Tape counter and reset button | ⑮ Input selector |
| ④ Recording indication lamp | ⑯ Dolby noise-reduction switch |
| ⑤ Level meters | ⑰ Bias selector |
| ⑥ Headphones jack | ⑱ Equalization selector |
| ⑦ Pause button | ⑲ Input level controls |
| ⑧ Record button | ⑳ Microphone jacks |
| ⑨ Play button | ㉑ Line output jacks |
| ⑩ Rewind/review button | ㉒ Record/playback connection socket |
| ⑪ Fast forward/cue button | ㉓ Line input jacks |
| ⑫ Stop button | |

DISASSEMBLY INSTRUCTIONS

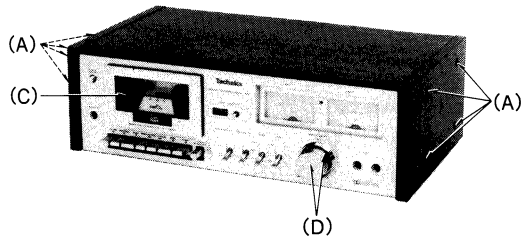

Fig. 2

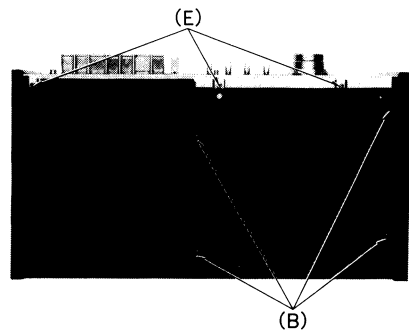

Fig. 3

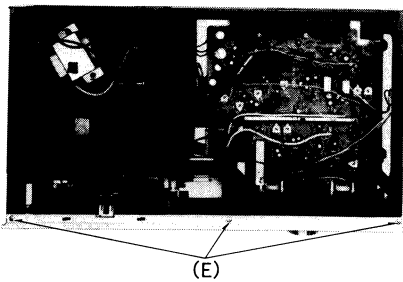

Fig. 4

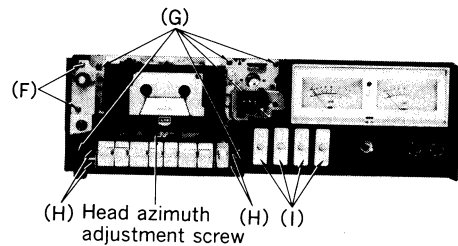

Fig. 5

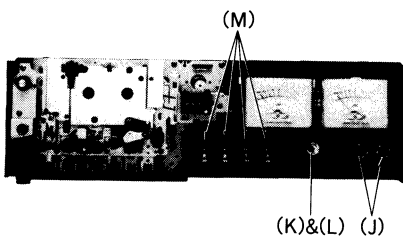

Fig. 6

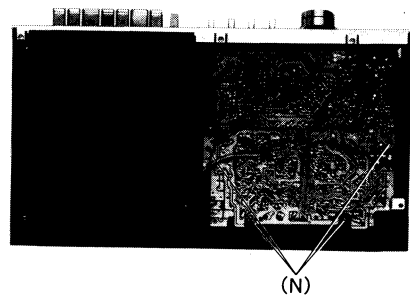

Fig. 7

Procedure	To remove — .	Remove — .	Pcs.	Shown in fig. — .
1	Case cover	• Screws (A)	8	2
2	Bottom cover	• Screws (B)	4	3
3	Front panel	• Cassette lid (C) ※	1	2
		• Control knobs (D)	2	2
		• Screws (E)	6	3, 4
4	Mechanism	• Screws (F)	2	5
		• Red screws (G)	6	5
5	Operation button unit and cassette holder	• Screws (H)	4	5
6	Circuit board	• Switch shelters (I)	4	5
		• Nuts (J)	2	6
		• Nuts and washer (K), (L)	1, 1	6
		• Screws (M)	4	6
		• Screws (N)	4	7

※The head azimuth can be adjusted by removing the cassette lid (C).

MEASUREMENT AND ADJUSTMENT METHOD

NOTE:

1. Make sure heads are clean.
2. Make sure capstan and pressure roller are clean.
3. Judgeable room temperature: $20 \pm 5^\circ\text{C}$ ($68 \pm 9^\circ\text{F}$).
4. Dolby NR switch: OUT.
5. Bias selector: LOW.
6. Equalizer selector: $120\mu\text{S}$.

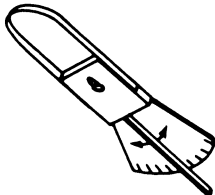
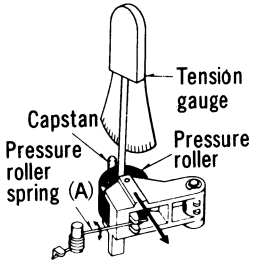
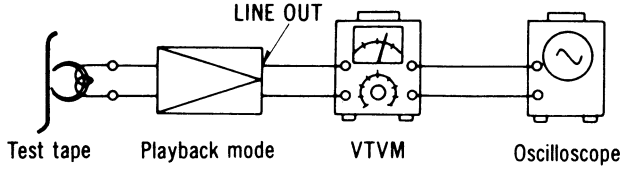
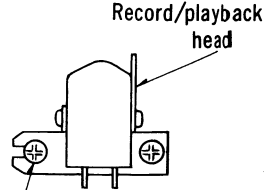
ITEM	MEASUREMENT & ADJUSTMENT	REMARKS
<p>Pressure of pressure roller</p> <p>Equipment: * Tension gauge (max. 500 gr)</p>  <p>Fig. 8</p>	<ol style="list-style-type: none"> 1. Place UNIT into playback mode. 2. Hook the tension gauge to pressure roller lever and pull it in the direction of the arrow as shown in fig. 9. 3. Measure the tension at the moment when the pressure roller moves away from the capstan. <div style="border: 1px solid black; padding: 5px; width: fit-content; margin: 10px auto;"> <p>Standard value: 400 ± 50 gr</p> </div> <p>Adjustment method</p> <p>Bend the part (A) of the pressure roller spring in either direction shown by the arrow until the correct pressure is attained.</p>	<p>* Playback mode</p>  <p>Fig. 9</p>
<p>Takeup tension</p> <p>Equipment: * Cassette torque meter ... QZZSRKCT</p>	<ol style="list-style-type: none"> 1. Mount cassette torque meter on UNIT. 2. Place UNIT into playback mode and read takeup torque. 3. Measure several times and determine the mean value. <div style="border: 1px solid black; padding: 5px; width: fit-content; margin: 10px auto;"> <p>Standard value: 50 ± 20 gr-cm</p> </div>	<p>* Playback mode</p>
<p>Head azimuth adjustment</p> <p>Equipment: * VTVM * Oscilloscope * Test tape (azimuth) ... QZZCFM</p>	<p>Record/playback head adjustment</p> <ol style="list-style-type: none"> 1. Test equipment connection is shown below.  <p>Fig. 10</p> <ol style="list-style-type: none"> 2. Play azimuth tape (QZZCFM 8kHz). 3. Adjust record/playback head angle adjustment screw (B) in fig. 11 so that output level at LINE OUT becomes maximum. 4. Measure both channels, and adjust levels for equal output. 5. After adjustment lock head adjustment screw with lacquer. 	<p>* Playback mode</p>  <p>Fig. 11</p>

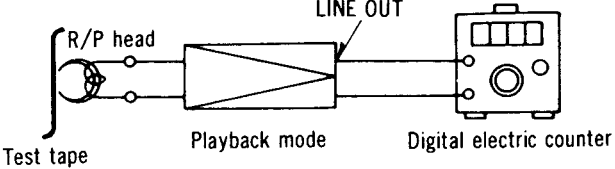
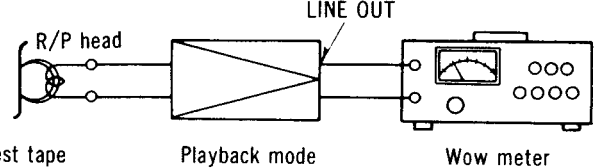
ITEM	MEASUREMENT & ADJUSTMENT	REMARKS
<p>Tape speed</p> <p>Equipment:</p> <ul style="list-style-type: none"> * Digital electronic counter or frequency counter (RP8067) * Test tape ... QZZCWAT 	<p>Tape speed accuracy</p> <p>1. Test equipment connection is shown below.</p>  <p style="text-align: center;">Fig. 12</p> <p>2. Play test tape (QZZCWAT 3,000Hz), and supply playback signal to frequency counter.</p> <p>3. Measure this frequency.</p> <p>4. On the basis of 3,000Hz, determine value by following formula:</p> $\text{Tape speed accuracy} = \frac{f - 3,000}{3,000} \times 100 (\%)$ <p style="text-align: center;">where, f = measured value</p> <p>5. Take measurement at middle section of tape.</p> <div style="border: 1px solid black; padding: 5px; width: fit-content; margin: 10px auto;"> <p style="text-align: center;">Standard value: ± 1.5%</p> </div> <p>Adjustment method</p> <ol style="list-style-type: none"> 1. Play the test tape (middle). 2. Adjust so that frequency becomes 3,000Hz. 3. Tape speed adjustment VR shown in fig. 28. <p>Tape speed fluctuation</p> <p>Make measurements in same manner as above (beginning, middle and end of tape), and determine difference between maximum and minimum values and calculate as follows:</p> $\text{Tape speed fluctuation} = \frac{f_1 - f_2}{3,000} \times 100 (\%)$ <p style="text-align: center;">f₁ = maximum value f₂ = minimum value</p> <div style="border: 1px solid black; padding: 5px; width: fit-content; margin: 10px auto;"> <p style="text-align: center;">Standard value: 1%</p> </div>	<p>* Playback mode</p>
<p>Wow and flutter</p> <p>Equipment:</p> <ul style="list-style-type: none"> * Wow meter * Test tape ... QZZCWAT 	<p>1. Test equipment connection is shown below.</p>  <p style="text-align: center;">Fig. 13</p> <p>2. Use wow test tape (3,000Hz) and measure its playback signal on wow meter.</p> <p>3. Wow and flutter is expressed in percentage and that measurement can be weighted by JIS network (WRMS).</p> <p>4. Measure at middle section of test tape.</p> <div style="border: 1px solid black; padding: 5px; width: fit-content; margin: 10px auto;"> <p style="text-align: center;">Standard value: 0.07% (WRMS)</p> </div>	<p>* Playback mode</p>

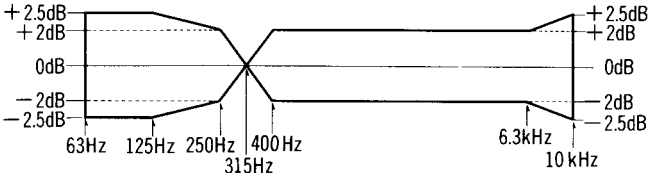
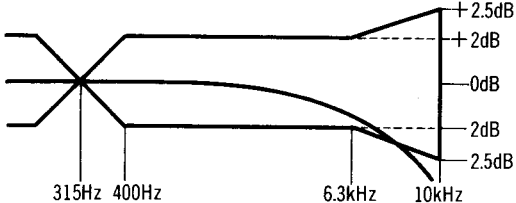
ITEM	MEASUREMENT & ADJUSTMENT	REMARKS								
<p>Playback frequency response</p> <p>Equipment:</p> <ul style="list-style-type: none"> * VTVM * Oscilloscope * Test tape ... C-FH 	<ol style="list-style-type: none"> 1. Test equipment connection is as same as "Head azimuth adjustment" but use the test tape (QZZCFM) instead of head azimuth tape (See fig. 10). 2. Place UNIT into playback mode. 3. Play frequency response test tape. 4. Measure output level at 8 kHz, 4 kHz, 1 kHz, 315 Hz, 250 Hz, 125 Hz and 63 Hz and compare output level with standard frequency 315 Hz, at LINE OUT. 5. Make measurement for both channels. 6. Make sure that the measured value is within the range specified in the frequency response chart. <p style="text-align: center;">Playback frequency response chart</p>  <p style="text-align: center;">Fig. 14</p>	<p>* Playback mode</p>								
<p>Playback frequency response</p>	<p>Adjustment</p> <ol style="list-style-type: none"> 1. If the measured value decreases at high frequency range, as shown in fig. 15, P.C.B. connection points (B) should be shorted to increase at high frequency range (See fig. 18 on page 7).  <p style="text-align: center;">Fig. 15</p> <p style="text-align: center;">The corrected value</p> <table border="1" data-bbox="529 1442 1028 1554" style="margin-left: auto; margin-right: auto;"> <thead> <tr> <th>4 kHz</th> <th>6 kHz</th> <th>8 kHz</th> <th>10 kHz</th> </tr> </thead> <tbody> <tr> <td>about +0.1 dB</td> <td>about +0.4 dB</td> <td>about +0.7 dB</td> <td>about +1.2 dB</td> </tr> </tbody> </table>	4 kHz	6 kHz	8 kHz	10 kHz	about +0.1 dB	about +0.4 dB	about +0.7 dB	about +1.2 dB	<p>* Playback mode</p>
4 kHz	6 kHz	8 kHz	10 kHz							
about +0.1 dB	about +0.4 dB	about +0.7 dB	about +1.2 dB							

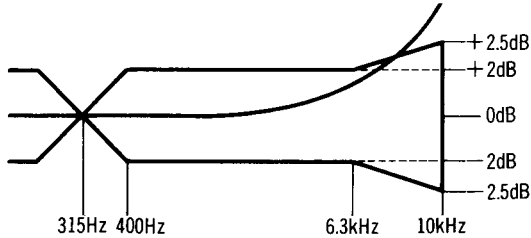
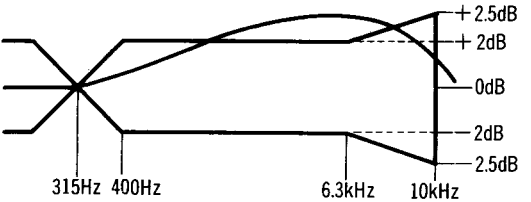
ITEM	MEASUREMENT & ADJUSTMENT	REMARKS																
	<p>2. If the measured value increases at high frequency range, as shown in fig. 16, P.C.B. connection points (A) should be unsoldered and connection points (B) should be shorted (See fig. 18 on page 7).</p>  <p style="text-align: center;">Fig. 16</p> <p style="text-align: center;">The corrected value</p> <table border="1" data-bbox="577 824 1074 940"> <tr> <td>4 kHz</td> <td>6 kHz</td> <td>8 kHz</td> <td>10 kHz</td> </tr> <tr> <td>about -0 dB</td> <td>about -0.2 dB</td> <td>about -0.4 dB</td> <td>about -0.8 dB</td> </tr> </table> <p>Caution: Please do not unsolder both connection points (A), (B) to prevent oscillation.</p> <p>3. If the measured value increases at middle frequency range, as shown in fig. 17, P.C.B. connection points (C) should be shorted (See fig. 18 on page 7).</p>  <p style="text-align: center;">Fig. 17</p> <p style="text-align: center;">The corrected value</p> <table border="1" data-bbox="577 1444 1074 1561"> <tr> <td>1 kHz</td> <td>2 kHz</td> <td>4 kHz</td> <td>6 kHz</td> </tr> <tr> <td>about -0.3 dB</td> <td>about -0.7 dB</td> <td>about -0.8 dB</td> <td>about -0.8 dB</td> </tr> </table>	4 kHz	6 kHz	8 kHz	10 kHz	about -0 dB	about -0.2 dB	about -0.4 dB	about -0.8 dB	1 kHz	2 kHz	4 kHz	6 kHz	about -0.3 dB	about -0.7 dB	about -0.8 dB	about -0.8 dB	
4 kHz	6 kHz	8 kHz	10 kHz															
about -0 dB	about -0.2 dB	about -0.4 dB	about -0.8 dB															
1 kHz	2 kHz	4 kHz	6 kHz															
about -0.3 dB	about -0.7 dB	about -0.8 dB	about -0.8 dB															
<p>Playback gain</p> <p>Equipment:</p> <ul style="list-style-type: none"> * VTVM * Oscilloscope * Test tape ... QZZCFM 	<ol style="list-style-type: none"> 1. Test equipment connection is shown in fig. 10. 2. Play standard recording level portion on test tape (QZZCFM 315Hz), and using VTVM measure the output level at LINE OUT jack. 3. Make measurement for both channels. <div style="border: 1px solid black; padding: 5px; text-align: center; margin: 10px 0;"> Standard value: 0.42V (-7dB) </div> <p>Adjustment</p> <ol style="list-style-type: none"> 1. If measured value is not standard, adjust VR1 (L-CH), VR2 (R-CH) (See fig. 28 on page 12). 2. After adjustment, check "Playback frequency response" again. 	<p>* Playback mode</p>																

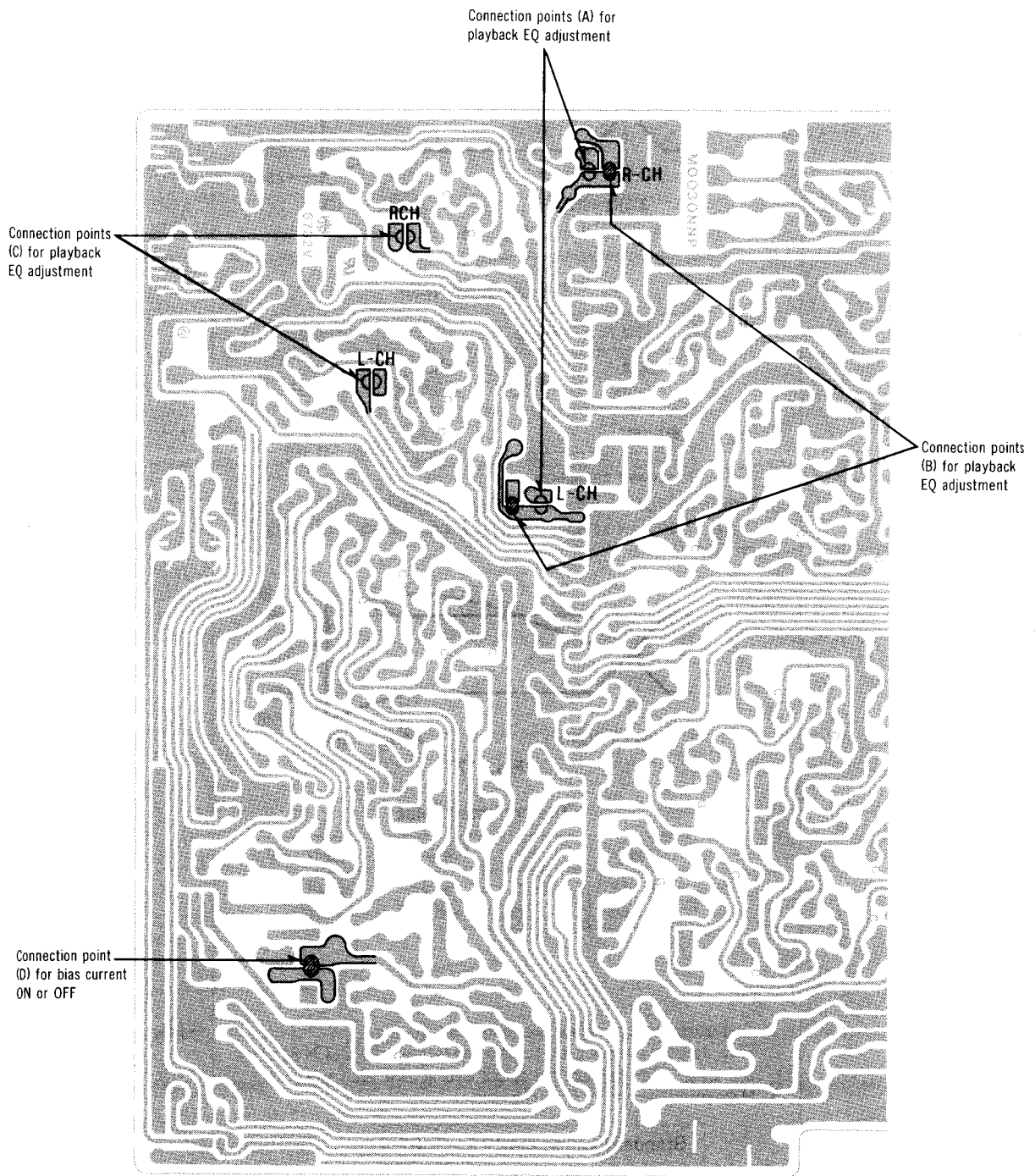
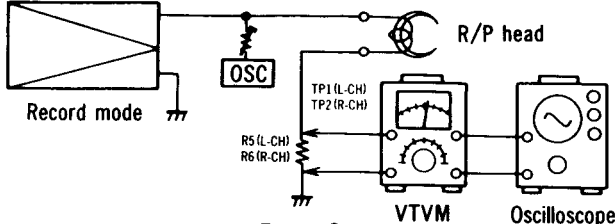
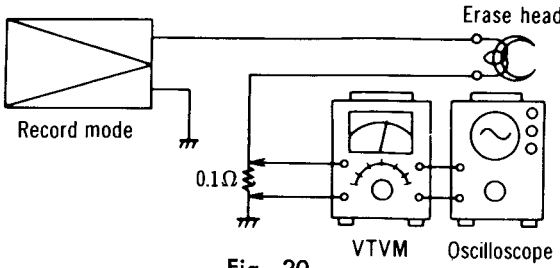
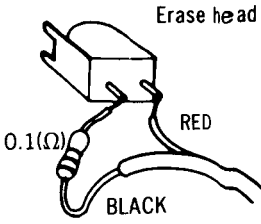
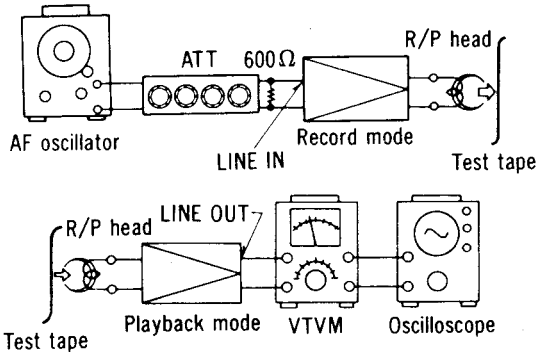
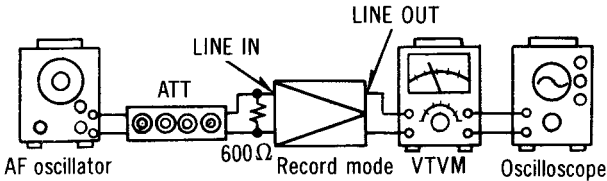
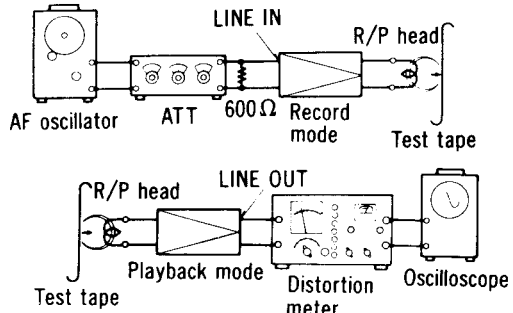
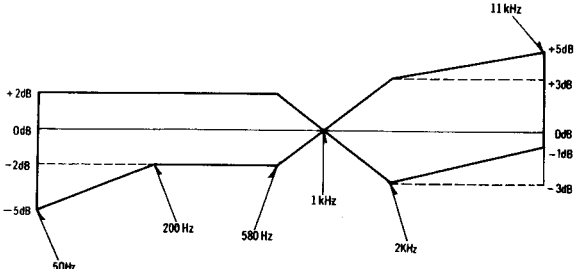
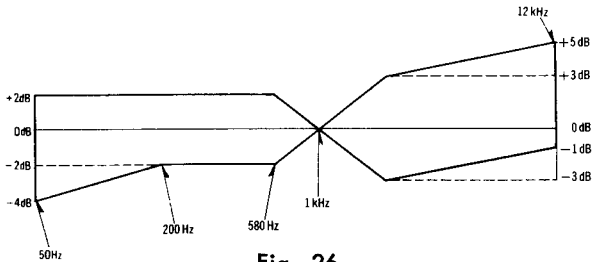
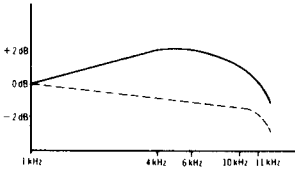

Fig. 18

ITEM	MEASUREMENT & ADJUSTMENT	REMARKS
<p>Playback S/N ratio</p> <p>Equipment:</p> <ul style="list-style-type: none"> * VTVM * Oscilloscope * Test tape ... QZZCFM * Empty cassette 	<ol style="list-style-type: none"> 1. Test equipment connection is shown in fig. 10. 2. Play standard recording level test tape (QZZCFM 315Hz) and read output level on VTVM. Refer to "Playback gain adjustment". 3. Place empty cassette (which has been cut) and play again. 4. Measure noise level at this time using VTVM, and determine ratio of this level to test tape output signal voltage (315Hz). <div style="border: 1px solid black; padding: 5px; width: fit-content; margin: 10px auto;"> <p>Standard value: Greater than 43 dB</p> </div> <p>An example calculation is shown below.</p> <p>A: E_s = playback output signal voltage of test tape (315Hz) B: E_n = playback output noise level $E_s = 0.42\text{ V} (-7\text{ dB})$ $E_n = 0.003\text{ V} (-50\text{ dB})$</p> $\text{S/N ratio} = \frac{E_s}{E_n} = \frac{0.42\text{ V}}{0.003\text{ V}} = 140$ $20 \log_{10} 140 = 43\text{ dB}$ $\text{S/N ratio} = E_s(\text{dB}) - E_n(\text{dB}) = -7 - (-50) = 43\text{ dB}$	<ul style="list-style-type: none"> * Playback mode
<p>Bias current</p> <p>Equipment:</p> <ul style="list-style-type: none"> * VTVM * Oscilloscope 	<ol style="list-style-type: none"> 1. Test equipment connection is shown below.  <p style="text-align: center;">Fig. 19</p> <ol style="list-style-type: none"> 2. Place UNIT into record mode, and bias selector to "LOW". 3. Read voltage on VTVM and calculate bias current by following formula: $\text{Bias current (A)} = \frac{\text{Value read on VTVM (V)}}{10 (\Omega)}$ <div style="border: 1px solid black; padding: 5px; width: fit-content; margin: 10px auto;"> <p>Standard value:</p> <p>250 $+130\mu\text{A}$ (LOW position) 275 $+130\mu\text{A}$ (MED position) 330 $+130\mu\text{A}$ (HIGH position)</p> </div> <ol style="list-style-type: none"> 4. Adjust L5 (L-CH) and L6 (R-CH) (See adjustment part location on page 12). 	<ul style="list-style-type: none"> * Record mode * When bias current is the adjusted on one channel only, note that bias current on the other channel may vary. * When L5 or L6 is the replaced, preset core position to bottom side of coil and then readjust optimum bias current.
<p>Erase current</p> <p>Equipment:</p> <ul style="list-style-type: none"> * VTVM * Oscilloscope * Resistor (0.1Ω) 	<ol style="list-style-type: none"> 1. Connect 0.1Ω resistor between ground side terminal of erase head ground lead wire removed (See fig. 21). 2. Connect VTVM to both ends of 0.1Ω resistor.  <p style="text-align: center;">Fig. 20</p>	<ul style="list-style-type: none"> * Record mode  <p style="text-align: center;">Fig. 21</p>

ITEM	MEASUREMENT & ADJUSTMENT	REMARKS
	<p>3. Place UNIT into record mode, and measure voltage across the 0.1Ω resistor.</p> <p>4. Determine erase current with the following formula:</p> $\text{Erase current (A)} = \frac{\text{Voltage across both ends of } 0.1\Omega}{0.1\Omega}$ <div style="border: 1px solid black; padding: 5px; margin: 10px auto; width: fit-content;"> <p>Standard value: 70 ± 33 mA (LOW position) 80 ± 33 mA (MED position) 90 ± 33 mA (HIGH position)</p> </div>	
<p>Overall gain</p> <p>Equipment:</p> <ul style="list-style-type: none"> * AF oscillator * VTVM * ATT * Oscilloscope * Test tape (reference blank tape) ... QZZCRA for Normal 	<p>1. Test equipment connection is shown in fig. 22.</p> <div style="text-align: center;">  <p>Fig. 22</p> </div> <p>2. Place UNIT into record mode, and equalizer selector to 120μS, bias selector to LOW (for normal tape).</p> <p>3. Supply 1 kHz signal (-24 dB) from AF oscillator, through ATT, to LINE IN.</p> <p>4. Adjust ATT until monitor level at LINE OUT becomes 0.42 V (-7 dB).</p> <p>5. Using test tape, make recording.</p> <p>6. Playback recorded tape, and make sure the value at LINE OUT on VTVM becomes 0.42 V.</p> <p>7. If measured value is not 0.42 V, adjust VR11 (L-CH), VR12 (R-CH) (See fig. 28 on page 12).</p> <p>8. Repeat from step (2).</p>	<ul style="list-style-type: none"> * Record/playback mode * LINE IN level control ... MAX * Standard input level: <ul style="list-style-type: none"> MIC... -72 ± 3 dB LINE IN ... -24 ± 3 dB DIN... -36 ± 3 dB
<p>Level meter</p> <p>Equipment:</p> <ul style="list-style-type: none"> * VTVM * Oscilloscope * AF oscillator * ATT 	<p>1. Test equipment connection is shown in fig. 23.</p> <div style="text-align: center;">  <p>Fig. 23</p> </div> <p>2. Supply 1 kHz signal from the AF oscillator, through the ATT, to the LINE IN jack.</p> <p>3. Adjust ATT so that the monitor level at LINE OUT becomes 0.42 V.</p> <p>4. Adjust VR9 (L-CH) and VR10 (R-CH) so that the level meters indicate 0 dB.</p>	<ul style="list-style-type: none"> * Record mode * LINE IN level control ... MAX

ITEM	MEASUREMENT & ADJUSTMENT	REMARKS
<p>Overall distortion</p> <p>Equipment:</p> <ul style="list-style-type: none"> * Distortion meter * AF oscillator * ATT * Oscilloscope * Test tape (reference blank tape) <ul style="list-style-type: none"> ... QZZCRA for Normal ... QZZCRX for CrO₂ 	<p>1. Test equipment connection is shown in fig. 24.</p> <div style="text-align: center;">  </div> <p style="text-align: center;">Fig. 24</p> <p>2. Supply 1kHz signal to LINE IN and adjust ATT so that output level at LINE OUT indicates 0.42V (-7 dB).</p> <p>3. Make recording.</p> <p>4. Playback and measure distortion factor of output signal.</p> <p>5. When the distortion factor does not satisfy the standard, check the bias current. When the bias current is lower than standard, distortion will increase.</p> <p>Care should be exercised in the adjustment because the bias current also has an influence on the overall frequency response. Refer to "The overall frequency response" and "The bias current adjustment".</p> <div style="border: 1px solid black; padding: 5px; margin: 10px auto; width: fit-content;"> <p style="text-align: center;">Standard value: Less than 2.3% (Normal) Less than 3.3% (CrO₂)</p> </div>	<ul style="list-style-type: none"> * Record/playback mode * LINE IN level control ... MAX
<p>Overall frequency response</p> <p>Equipment:</p> <ul style="list-style-type: none"> * VTVM * AF oscillator * ATT * Test tape (reference blank tape) <ul style="list-style-type: none"> ... QZZCRA for Normal ... QZZCRX for CrO₂ 	<p>Note:</p> <p>Before measuring, and adjusting, make sure of the playback frequency response (For the method of measurement, please refer to the playback frequency response).</p> <ol style="list-style-type: none"> 1. Test equipment connection is shown in fig. 22. 2. Load reference blank test tape and place UNIT into record mode. 3. Supply 1kHz signal from AF oscillator through ATT to LINE IN. 4. Adjust ATT so that input level is -20dB below standard recording level (standard recording level = 0VU). 6. Record each frequency 50Hz, 100Hz, 200Hz, 1kHz, 2kHz, 4kHz and 11kHz (12kHz for CrO₂ tape) at the same level. 7. Playback and express in dB the difference between playback output level of each frequency based on playback output level of 1kHz. 8. Make sure that the measured value is within the range specified in the overall frequency response chart. <div style="text-align: center;"> <p>Overall frequency response chart (Normal)</p>  </div> <p style="text-align: center;">Fig. 25</p> <ol style="list-style-type: none"> 9. Set the bias and equalizer selector to CrO₂ position. 10. Measure as same as manner above. 	<ul style="list-style-type: none"> * Record/playback mode * LINE IN level control ... MAX

ITEM	MEASUREMENT & ADJUSTMENT	REMARKS
	<p>11. Make sure that the measured value is within the range specified in the overall frequency response chart for CrO₂ tape below.</p> <p style="text-align: center;">Overall frequency response chart (CrO₂)</p>  <p style="text-align: center;">Fig. 26</p>	
<p>Overall frequency response adjustment (As a standard for adjustment)</p>	<ol style="list-style-type: none"> 1. When the frequency response between the middle and high-frequency range becomes higher than the standard value, as shown by the solid line in fig. 27, increase the bias current by turning L5 (L-CH), L6 (R-CH). 2. When it becomes lower, as shown by dotted line, reduce the bias current by turning L5 (L-CH), L6 (R-CH). <p>Note: For the method of bias current measurement, refer to "Bias current adjustment" on page 8.</p>  <p style="text-align: center;">Fig. 27</p>	
<p>Dolby NR circuit Equipment: * VTVM * AF oscillator * ATT * Oscilloscope</p>	<ol style="list-style-type: none"> 1. Place UNIT into record mode, set the Dolby NR switch to OUT position and supply to LINE IN to obtain -34.5dB at TP3 (L-CH), TP4 (R-CH) (frequency 5kHz). 2. Confirm that the value at IN position is 8dB greater than the value at OUT position of Dolby NR switch. 3. When it is not in condition above, adjust as follows. 4. Set VR5 (L-CH), VR6 (R-CH) to maximum. 5. Set the Dolby NR switch to IN position. 6. At this time adjust VR7 (L-CH), VR8 (R-CH) so that the reading of VTVM become 10dB greater than the value in step (1) above. 7. Adjusting VR5 (L-CH), VR6 (R-CH), make the reading of VTVM become 2dB smaller than the value obtained through the adjustment a in step (6) above. 	<ul style="list-style-type: none"> * Record mode * LINE IN level control ...MAX * Stop the bias oscillation by unsoldering point (D) shown in adjustment parts location on page 7.
<p>Overall S/N ratio Equipment: * VTVM * AF oscillator * ATT * Oscilloscope * Test tape (reference blank tape) ... QZZCRA</p>	<ol style="list-style-type: none"> 1. Test equipment connection is shown in fig. 22. 2. Supply 1 kHz signal to LINE IN and adjust ATT so that output level at LINE OUT indicates 0.42V (-7 dB). 3. Make recording. 4. Make another recording without supplying signal (disconnect input plug to LINE IN). 5. Rewind to recorded part and playback. 6. Measure output signal level and no signal level (noise), and determine the ratio in decibels (dB). 7. The value is difference between "Playback S/N and overall S/N", but for decibel calculation refer to "Playback S/N measurement" on page 8. <div style="border: 1px solid black; padding: 5px; text-align: center; margin-top: 10px;"> <p>Standard value: Greater than 42dB (without NAB filter)</p> </div>	<ul style="list-style-type: none"> * Record/playback mode * LINE IN level control ...MAX * Erase the tape with a bulk tape eraser.

HOW TO INSTALL THE RECORD-MUTING SWITCH

1. Lock the record button, and then mount it with screw (B) so that the cap and micro switch (A) do not contact each other.
2. Then play the music tape. During the playback, press the record button lightly several times, confirm whether the playback sound is interrupted or not.

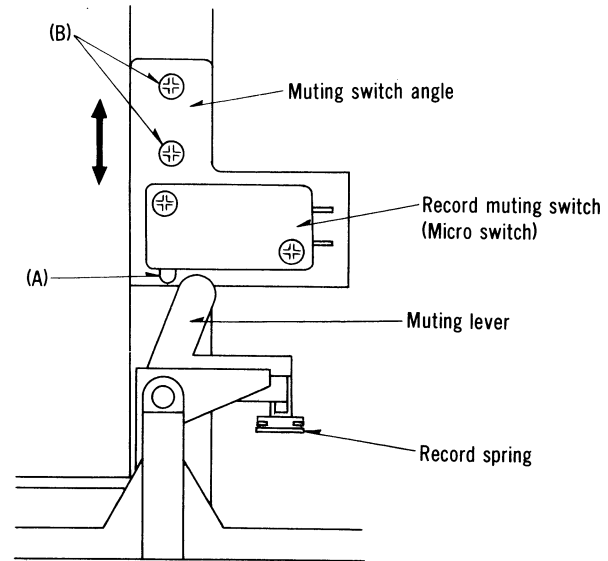

ADJUSTMENT PARTS LOCATION

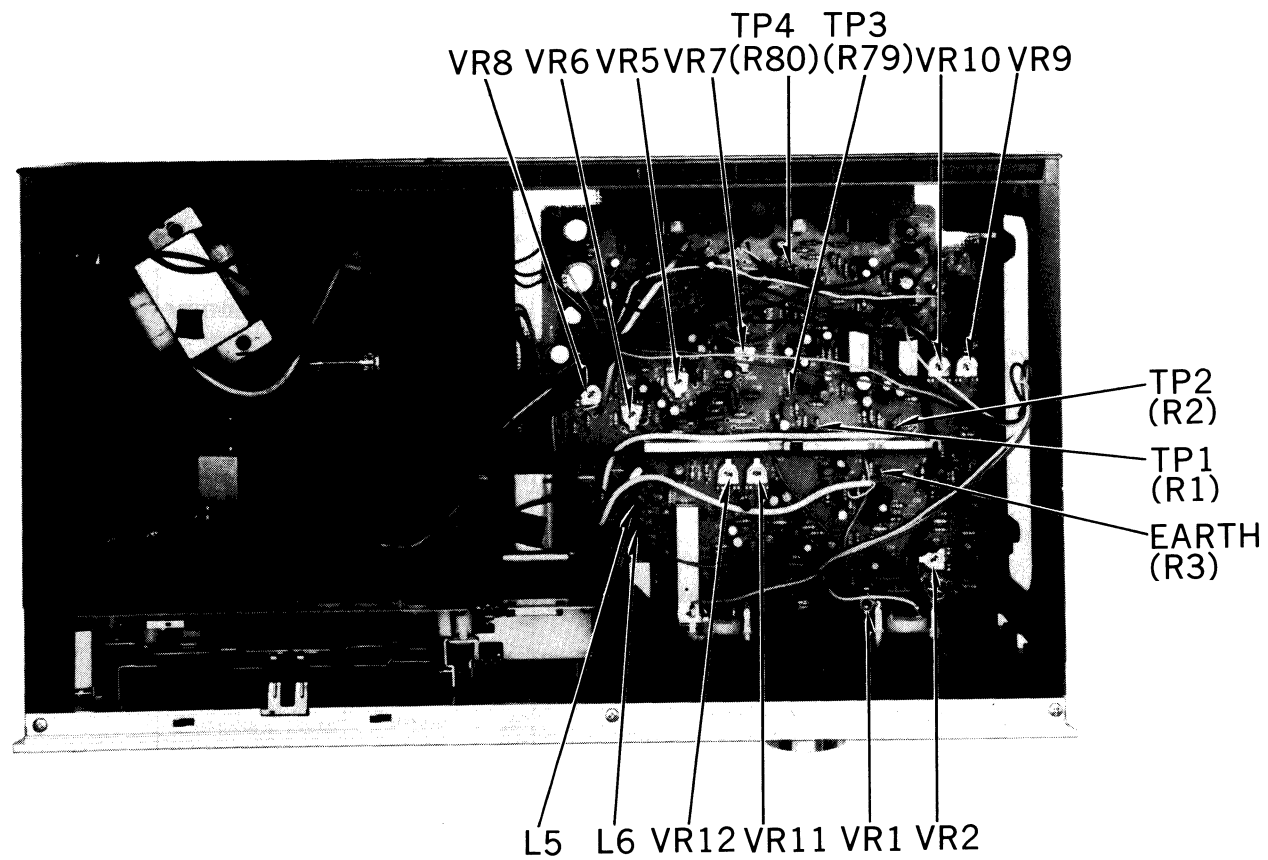

ELECTRICAL PARTS LOCATION

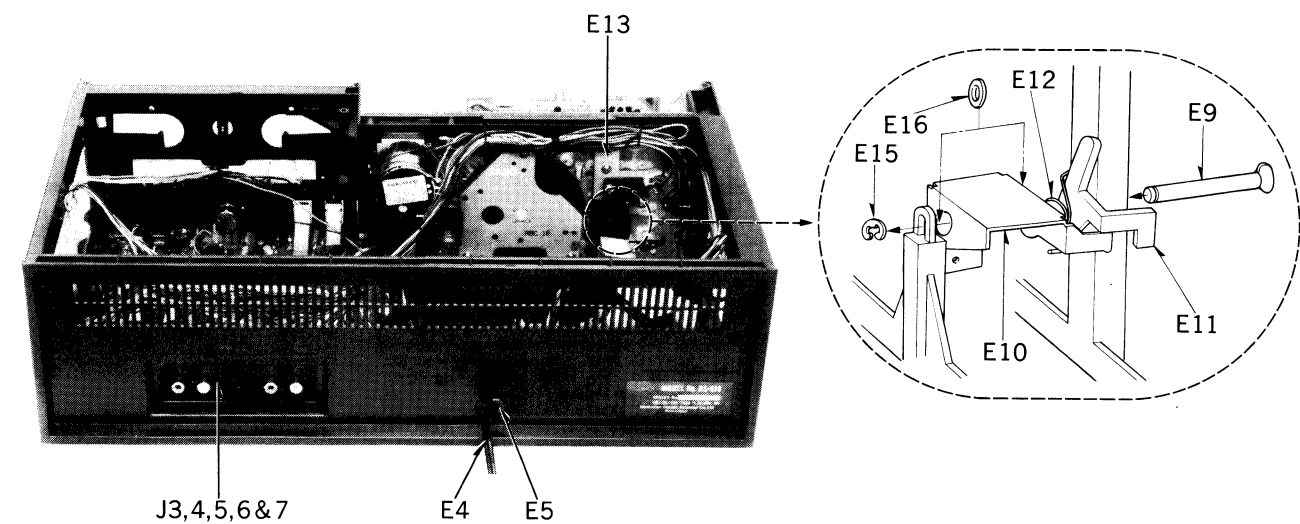
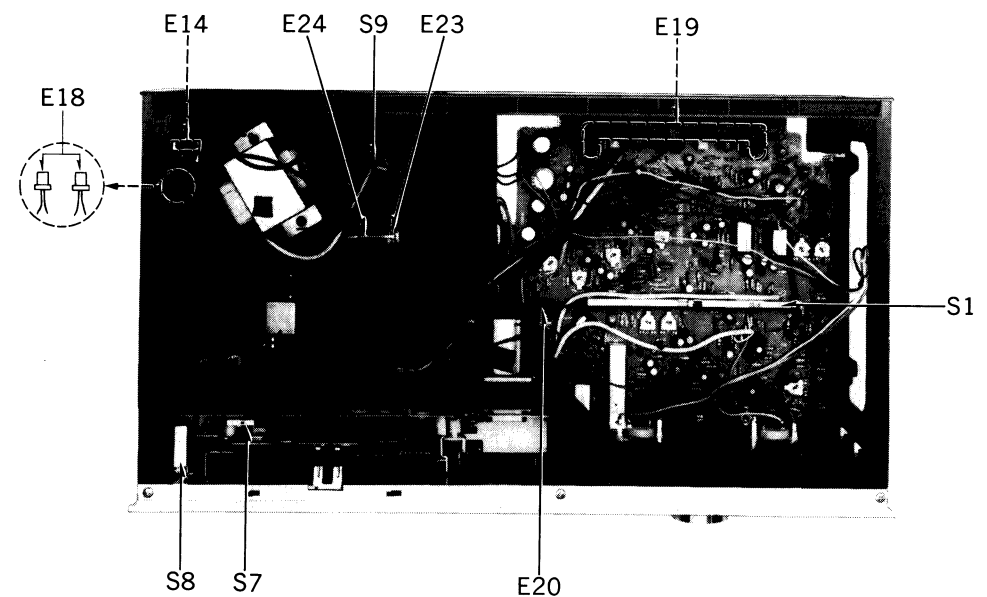
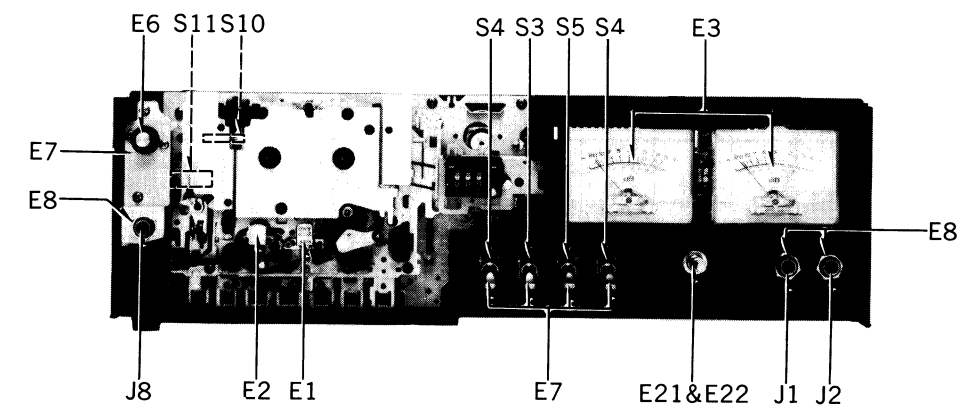

NOTE: **S** indicates that only parts specified by the manufacturer be used for safety.

Ref. No.	Part No.	Part Name & Description
ELECTRICAL PARTS		
E1	QWY4113Z	Record/Playback Head
E2	QWY2122ZA	Erase Head
E3	QSL1092RNM	Level Meter with Pilot Lamp
E4	QFC1203M	AC Power Cord
E5	QTD1129	Power Cord Bushing
E6	QXBM0018	Push Button (Power Switch)
E7	QMAM0083	Power Switch Angle
E8	QNJ1070	Nut
E9	QMS1236	Record Lever Shaft
E10	QMLM0033	Record Lever
E11	QMLM0034	Muting Lever
E12	QBN1621	Muting Lever Spring
E13	QFMF0007	Muting Switch Angle
E14	QTSM0020	Earth Metal
E15	XUC3FT	Stop Ring $\phi 3$
E16	QBK7005	Washer
E18	QJT1029	Connection Terminal
E19	QKJM0017	Jack Cover Plate
E20	QBSM0001	Recording Connection Wire
E21	XWG9D15AW	Washer for Volume
E22	QNQ1039	Nut for Volume
E23	QTF1056	Fuse Holder
E24	XBA2E03NS5	Fuse (0.3A)

H

1.

2.

CABINET PARTS

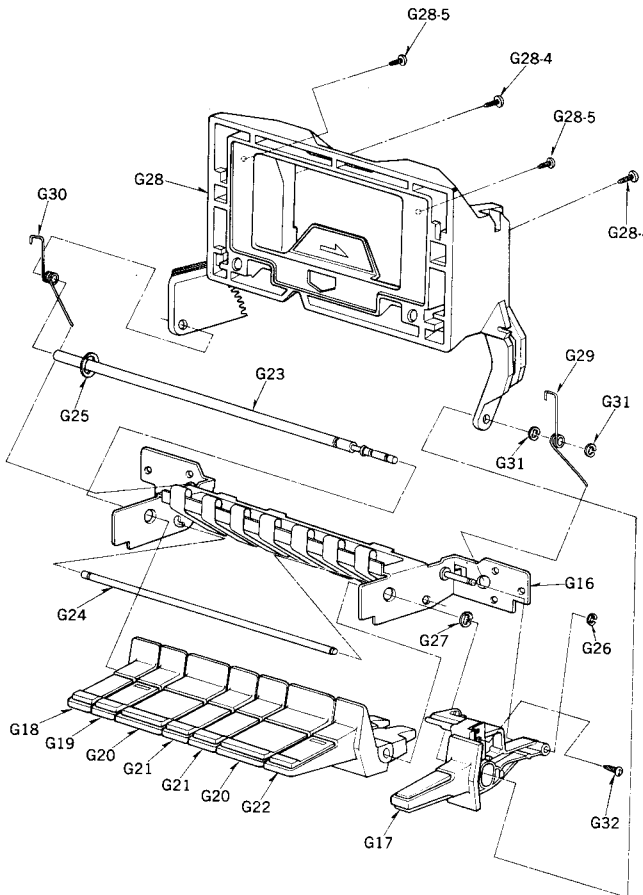
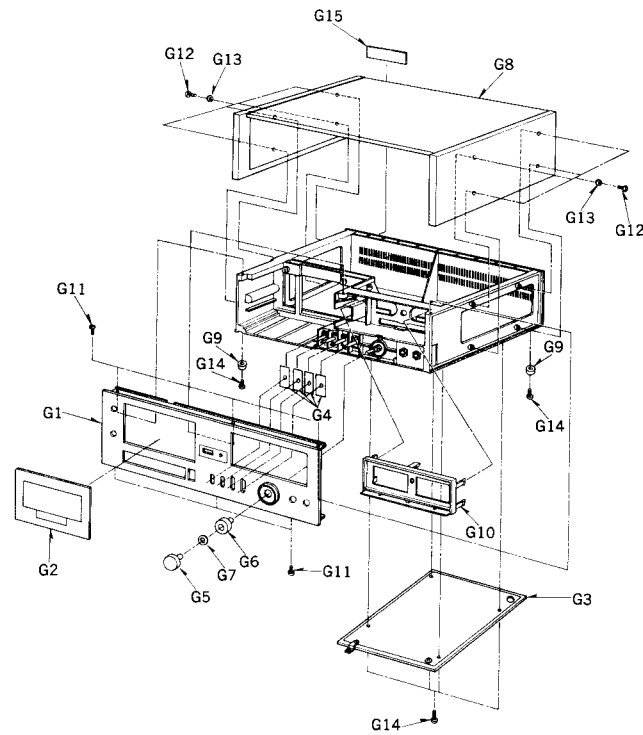

NOTE:  indicates that only parts specified by the manufacturer be used for safety.

Ref. No.	Part No.	Part Name & Description
CABINET PARTS		
G1	QYPM0025	Front Panel Assembly
G2	QYFM0031	Cassette Lid Assembly
G3	QYCM0020	Bottom Board Assembly
G4	QBH2021S	Switch Shelter
G5	QYT0458	Volume Knob-1
G6	QYT0457	Volume Knob-2
G7	QBW2066	Volume Washer
G8	QYWM0010	Wooden Case Cover
G9	QKA1050	Rubber Foot
G10	QYKM0001	Level Meter Cover Assembly
G11	XTN3+8B	Tapping Screw $\varnothing 3 \times 8$
G12	XTN4+20B	Tapping Screw $\varnothing 4 \times 20$ (Black)
G13	XWG4E10FZ	Washer (Black)
G14	XTN3+10B	Tapping Screw $\varnothing 3 \times 10$
G15	QGSM0087	Name Plate
G16	QXA0669	Push Button Holding Angle
G17	QXB0556	Timer Button Assembly
G18	QGO1473	Pause Button
G19	QGO1474	Record Button
G20	QGO1476	Button (Playback, Stop)
G21	QGO1477	Button (FF, REW)
G22	QGO1475	Eject Button
G23	QMN2240	Bush Button Shaft-A
G24	QMN1861	Bush Button Shaft-B
G25	QNQ1080	Stop Ring
G26	XUC25FT	Stop Ring $\varnothing 2.5$
G27	XUC4FT	Stop Ring $\varnothing 4$
G28	QYFM0029	Cassette Holder Assembly
G28-4	XTN26+8B	Tapping Screw $\varnothing 2.6 \times 8$
G28-5	XTN26+6B	Tapping Screw $\varnothing 2.6 \times 6$
G29	QBN1622	Lid Spring-1
G30	QBN1623	Lid Spring-2
G31	XUC3FT	Stop Ring $\varnothing 3$
G32	XTN26+5B	Tapping Screw $\varnothing 2.6 \times 5$
G33	QYMM0047	Main Case Assembly
ACCESSORIES		
A1	RP023A	Connection Cord-G
A2	QFT1TCCPTRJZ	Demonstration Tape
A3	 XBA2E03NS5	Fuse (0.3A)
A4	QQT2302	Instruction Book
PACKINGS		
P1	QPNM0120	Inside Carton
P2	QPAM0024	Inner Carton
P3	XZB50X65A02	Poly Bag

SCHEMATIC DIAGRAM MODEL RS-616

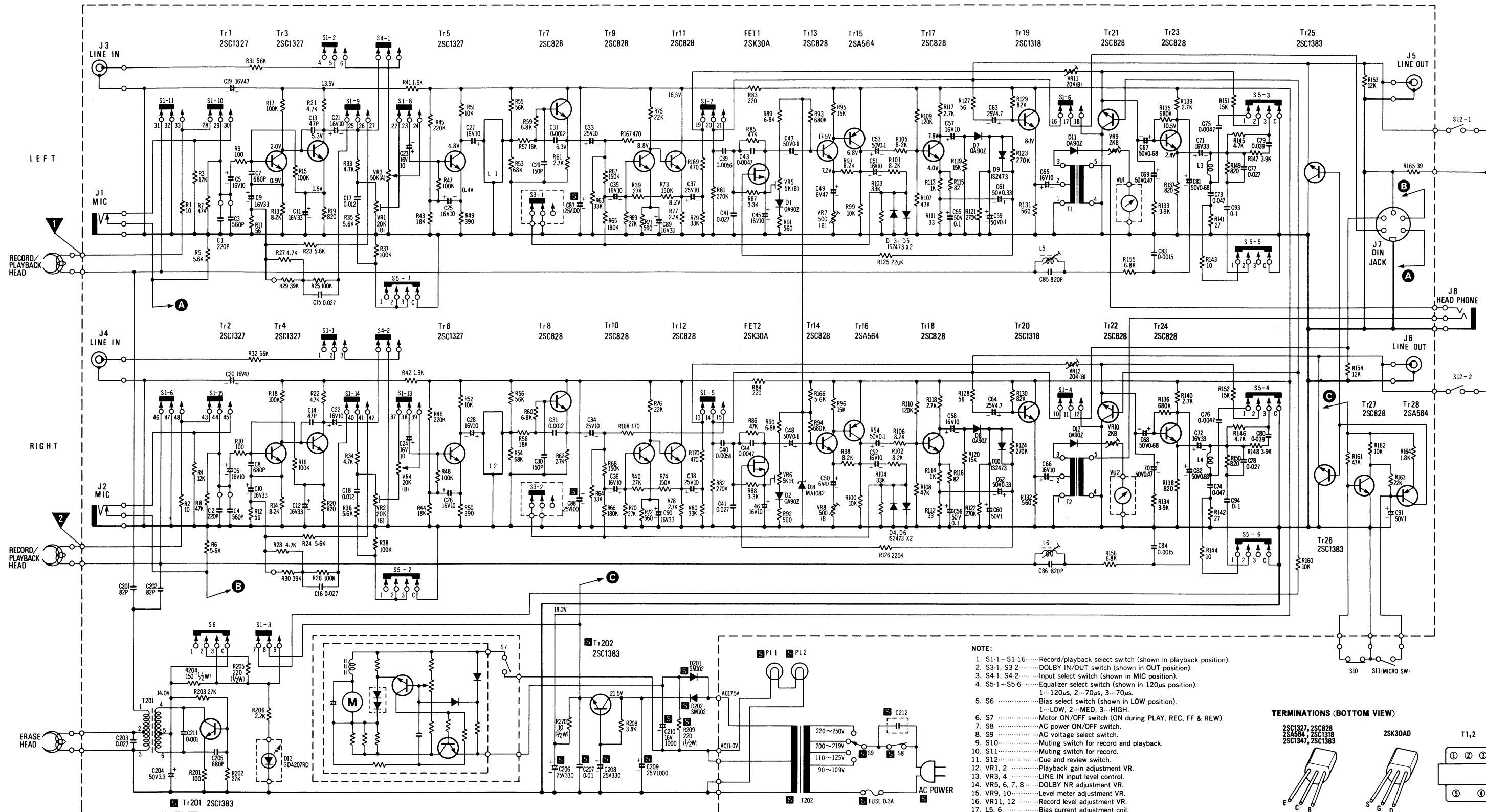

- NOTE:**
- S1-1 - S1-16 Record/playback select switch (shown in playback position).
 - S3-1, S3-2 DOLBY IN/OUT switch (shown in OUT position).
 - S4-1, S4-2 Input select switch (shown in MIC position).
 - S5-1 - S5-6 Equalizer select switch (shown in 120 μ s position).
1...120 μ s, 2...70 μ s, 3...70 μ s.
 - S6 Bias select switch (shown in LOW position).
1...LOW, 2...MED, 3...HIGH.
 - S7 Motor ON/OFF switch (ON during PLAY, REC, FF & REW).
 - S8 AC power ON/OFF switch.
 - S9 AC voltage select switch.
 - S10 Muting switch for record and playback.
 - S11 Muting switch for record.
 - S12 Cue and review switch.
 - VR1, 2 Playback gain adjustment VR.
 - VR3, 4 LINE IN input level control.
 - VR5, 6, 7, 8 DOLBY NR adjustment VR.
 - VR9, 10 Level meter adjustment VR.
 - VR11, 12 Record level adjustment VR.
 - L5, 6 Bias current adjustment coil.
 - Resistor values are in ohms (Ω), 1/4 watt unless specified otherwise. K=1,000.
 - Capacitor values are in microfarads (μ F) unless specified otherwise. P=Pico-farads.
 - The mark (∇) shows test point. e.g. ∇ = test point 1.
 - All voltage values shown in circuitry are under no signal condition with volume control at minimum position. For measurement, use VTVM.

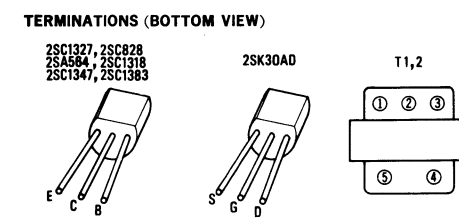

NOTE: RESISTORS ERDCarbon
 ERGMetal oxide
 CAPACITORS ECEAElectrolytic
 ECCDCeramic
 ECKDCeramic
 EQCMPolyster
 EQCSPolystyrene

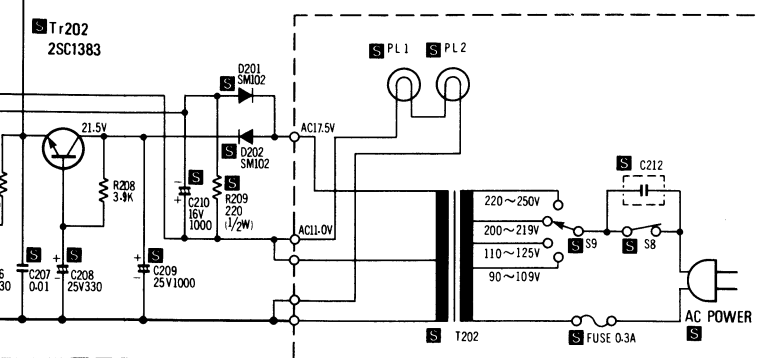
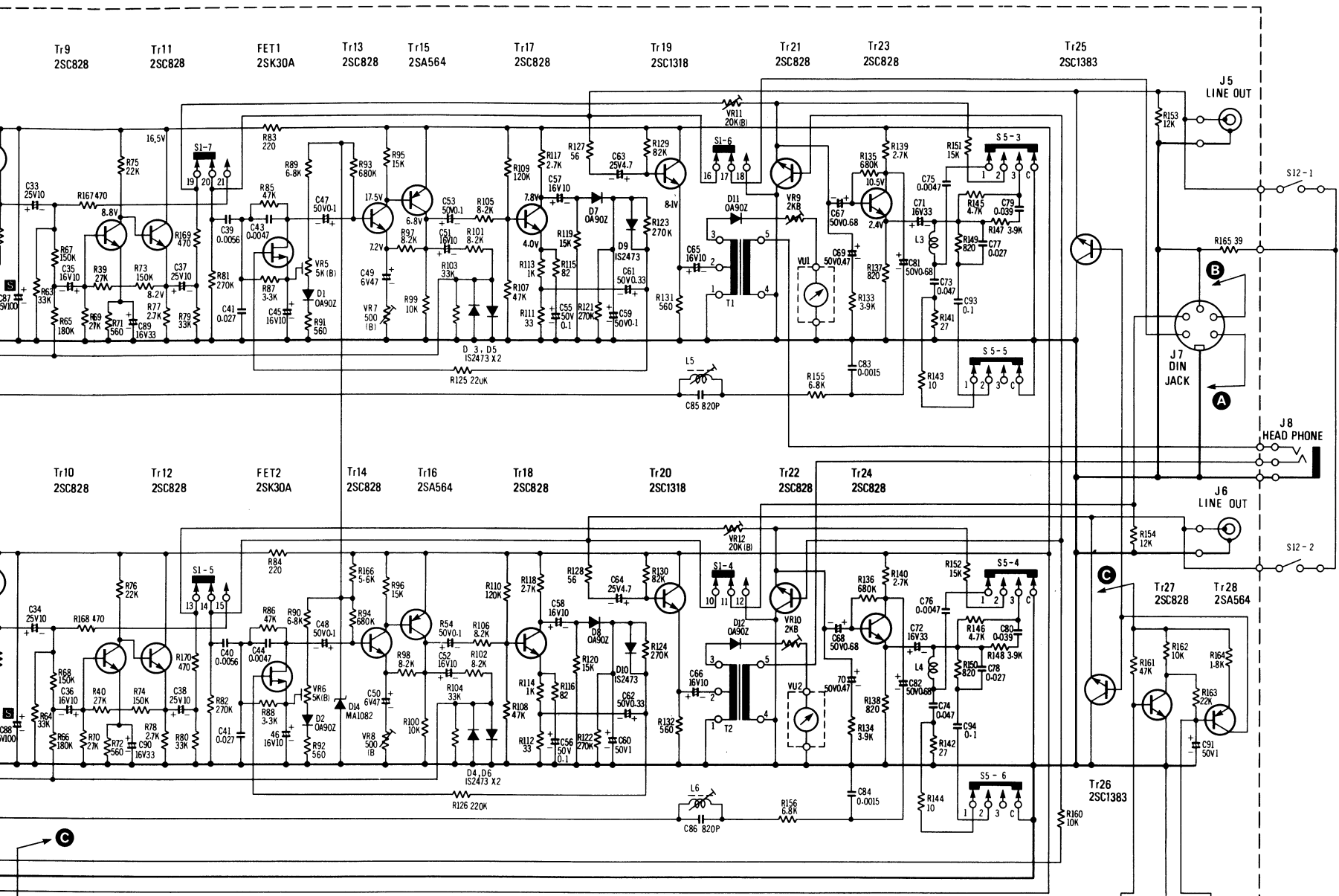

- NOTE:
- S1-1 - S1-16Record/playback select switch (shown in playback position).
 - S3-1, S3-2DOLBY IN/OUT switch (shown in OUT position).
 - S4-1, S4-2Input select switch (shown in MIC position).
 - S5-1 - S5-6Equalizer select switch (shown in 120μs position).
 1...120μs, 2...70μs, 3...70μs.
 - S6Bias select switch (shown in LOW position).
 1...LOW, 2...MED, 3...HIGH.
 - S7Motor ON/OFF switch (ON during PLAY, REC, FF & REW).
 - S8AC power ON/OFF switch.
 - S9AC voltage select switch.
 - S10Muting switch for record and playback.
 - S11Muting switch for record.
 - S12Cue and review switch.
 - VR1, 2Playback gain adjustment VR.
 - VR3, 4LINE IN input level control.
 - VR5, 6, 7, 8DOLBY NR adjustment VR.
 - VR9, 10Level meter adjustment VR.
 - VR11, 12Record level adjustment VR.
 - VR13, 14Bias current adjustment coil.
 - L5, 6Resistor values are in ohms (Ω), 1/4 watt unless specified otherwise.
 K = 1,000.
 μ = microfarads.
 P = Pico-farads.
 - The mark (▼) shows test point. e.g. ▼ = test point 1.
 - All voltage values shown in circuitry are under no signal condition with volume control at minimum position.
 For measurement, use VTVM.

TERMINATIONS (BOTTOM VIEW)

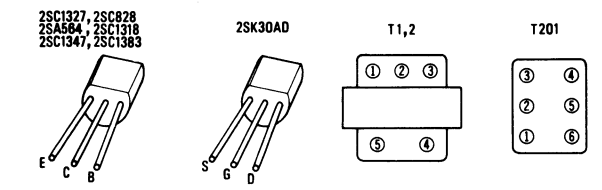

NOTE: ■ indicates that only parts specified by the manufacturer be used for safety.

Ref. No.	Part No.	Part Name & Description
TRANSISTORS		
Tr1, 2, 3, 4, 5, 6	2SC1327	Transistor
Tr7, 8, 9, 10, 11, 12, 13, 14	2SC828	"
Tr15, 16	2SA564	"
Tr17, 18	2SC828	"
Tr19, 20	2SC1318	Transistor
Tr21, 22, 23, 24	2SC828	"
Tr25, 26	2SC1383	"
Tr27	2SC828	"
Tr28	2SA564	"
Tr201, 202	2SC1383	"
FET		
FET1, 2	2SK30AD	FET
DIODES & RECTIFIERS		
D1, 2	0A90Z	Diode
D3, 4, 5, 6	1S2473	"
D7, 8	0A90Z	"
D9, 10	1S2473	"
D11, 12	0A90Z	"
D13	GD4207RD	Light Emitting Diode
D14	MA1082	Diode
D201, 202	SM102	Rectifier
TRANSFORMERS		
T1, 2	QLT2D26X	Headphone Transformer
T201	QLB0158	Bias OSC Transformer
T202	QLPZ9ELX	Power Transformer
COILS		
L1, 2	QLM9Z5K	MPX Filter
L3, 4	QLQX2421Y	Record EQ Coil
L5, 6	QLQX1032W	Bias Trap Coil
SWITCHES		
S1	QSSG206F	Slide Switch (Record/Playback Selector)
S3, 4	QES1383	Lever Switch (DOLBY IN/OUT, Input Select)
S5	QES1382	Lever Switch (EQ Select)
S6	QES1441H	Lever Switch (Bias Select)
S7	QSB0178	Leaf Switch (Motor ON/OFF)
S8	ESB70124	Push Switch (Power ON/OFF)
S9	QSR1407	Rotary Switch (AC Voltage Selector)
S10	QSB0178	Leaf Switch (Muting)
S11	QSM0070	Micro Switch (Muting)
S12	QSB0186	Leaf Switch (Cue and Review)
JACKS		
J1, 2	QJA0256H	TMS Jack (MIC)
J3, 4, 5, 6, 7	QEJ5002H	Line IN/OUT & DIN Jack Assembly
J8	QJA0255H	TMS Jack (PHONES)

Ref. No.	Part No.	Ref. No.	Part No.	Ref. No.	Part No.	
RESISTORS						
R1, 2	ERD25TJ100	R121, 122, 123, 124	ERD25TJ274	C43, 44	EQCM05472JZ	
R3, 4	ERD25TJ123	R125, 126	ERD25TJ224	C45, 46	ECEA1HS100	
R5, 6	ERD25TJ562	R127, 128	ERD25TJ560	C47, 48	ECEA50MR1R	
R7, 8	ERD25TJ473	R129, 130	ERD25TJ823	C49, 50	ECEA1AS470	
R9, 10	ERD25TJ101	R131, 132	ERD25TJ561	C51, 52	ECEA1HS100	
R11, 12	ERD25TJ560	R133, 134	ERD25TJ392	C53, 54, 55, 56	ECEA50ZR1	
R13, 14	ERD25TJ822	R135, 136	ERD25TJ821	C57, 58	ECEA1HS100	
R15, 16	ERD25TJ104	R137, 138	ERD25TJ821	C59, 60	ECEA50ZR1	
R17, 18	ERD25TJ104	R139, 140	ERD25TJ272	C61, 62	ECEA50ZR3	
R19, 20	ERD25TJ821	R141, 142	ERD25TJ270	C63, 64	ECEA1JS47R	
R21, 22	ERD25TJ472	R143, 144	ERD25TJ100	C65, 66	ECEA1HS100	
R23, 24	ERD25TJ562	R145, 146	ERD25TJ472	C67, 68	ECEA50ZR68	
R25, 26	ERD25TJ104	R147, 148	ERD25TJ392	C69, 70	ECEA1CS330	
R27, 28	ERD25TJ472	R149, 150	ERD25TJ821	C73, 74	EQCM05473KZ	
R29, 30	ERD25TJ393	R151, 152	ERD25TJ153	C75, 76	EQCM05472KZ	
R31, 32	ERD25TJ562	R153, 154	ERD25TJ123	C77, 78	EQCM05273KZ	
R33, 34	ERD25TJ472	R155, 156	ERD25TJ682	C79, 80	EQCM05393KZ	
R35, 36	ERD25TJ562	R160	ERD25TJ103	C81, 82	ECEA50ZR68	
R37, 38	ERD25TJ104	R161	ERD25TJ473	C83, 84	ECKD1H152K	
R39, 40	ERD25TJ273	R162	ERD25TJ103	C85, 86	EQCS1821KZ	
R41, 42	ERD25TJ152	R163	ERD25TJ223	C87, 88	ECEA1ES101	
R43, 44	ERD25TJ183	R164	ERD25TJ182	C89, 90	ECEA1CS330	
R45, 46	ERD25TJ224	R165	ERD25TJ390	C91	ECEA2AS010	
R47, 48	ERD25TJ104	R166	ERD25TJ562	C93, 94	EQCM05104KZ	
R49, 50	ERD25TJ391	R167, 168	ERD25TJ471	C201, 202	ECCD1H820K	
R51, 52	ERD25TJ103	R169, 170	ERD25TJ471	C203	EQCM1273KZ	
R53, 54	ERD25TJ683	R201	ERD25TJ101	C204	ECEA2AS3R3	
R55, 56	ERD25TJ563	R202, 203	ERD25TJ273	C205	EQCS1681KZ	
R57, 58	ERD25TJ183	R204	ERD50TJ151	C206	ECEA1ES331	
R59, 60	ERD25TJ682	R205	ERD50TJ221	C207	ECKD1H103PF	
R61, 62	ERD25TJ272	R206	ERD25TJ222	C208	ECEA1ES331	
R63, 64	ERD25TJ333	R207	ERD50TJ100	C209	ECEA1VS102	
R65, 66	ERD25TJ184	R208	ERD25TJ392	C210	ECEA1CS102	
R67, 68	ERD25TJ154	R209	ERD50TJ221	C211	ECKD1H102K	
R69, 70	ERD25TJ273	VARIABLE RESISTORS			C212	EQCM6223KZ
R71, 72	ERD25TJ561	VR1, 2	EVL33AA00B24			
R73, 74	ERD25TJ154	VR3, 4	EWKN3AF21A54			
R75, 76	ERD25TJ223	VR5, 6	EVL33AA00B53			
R77, 78	ERD25TJ272	VR7, 8	EVL33AA00B52			
R79, 80	ERD25TJ333	VR9, 10	EVL33AA00B23			
R81, 82	ERD25TJ274	VR11, 12	EVL33AA00B24			
R83, 84	ERD25TJ221	CAPACITORS				
R85, 86	ERD25TJ473	C1, 2	ECKD1H221K			
R87, 88	ERD25TJ332	C3, 4	ECKD1H561K			
R89, 90	ERD25TJ682	C5, 6	ECEA16M10R			
R91, 92	ERD25TJ561	C7, 8	ECKD1H681K			
R93, 94	ERD25TJ684	C9, 10, 11, 12	ECEA1CS330			
R95, 96	ERD25TJ153	C13, 14	ECCD1H470K			
R97, 98	ERD25TJ822	C15, 16	EQCM05273KZ			
R99, 100	ERD25TJ103	C17, 18	EQCM05123KZ			
R101, 102	ERD25TJ822	C19, 20	ECEA1ES470			
R103, 104	ERD25TJ333	C21, 22, 23, 24, 25, 26, 27, 28	ECEA1HS100			
R105, 106	ERD25TJ822					
R107, 108	ERD25TJ473					
R109, 110	ERD25TJ124					
R111, 112	ERD25TJ330					
R113, 114	ERD25TJ102					
R115, 116	ERD25TJ820					
R117, 118	ERD25TJ272					
R119, 120	ERD25TJ153					

WIRING CONNECTION DIAGRAM MODEL RS-616

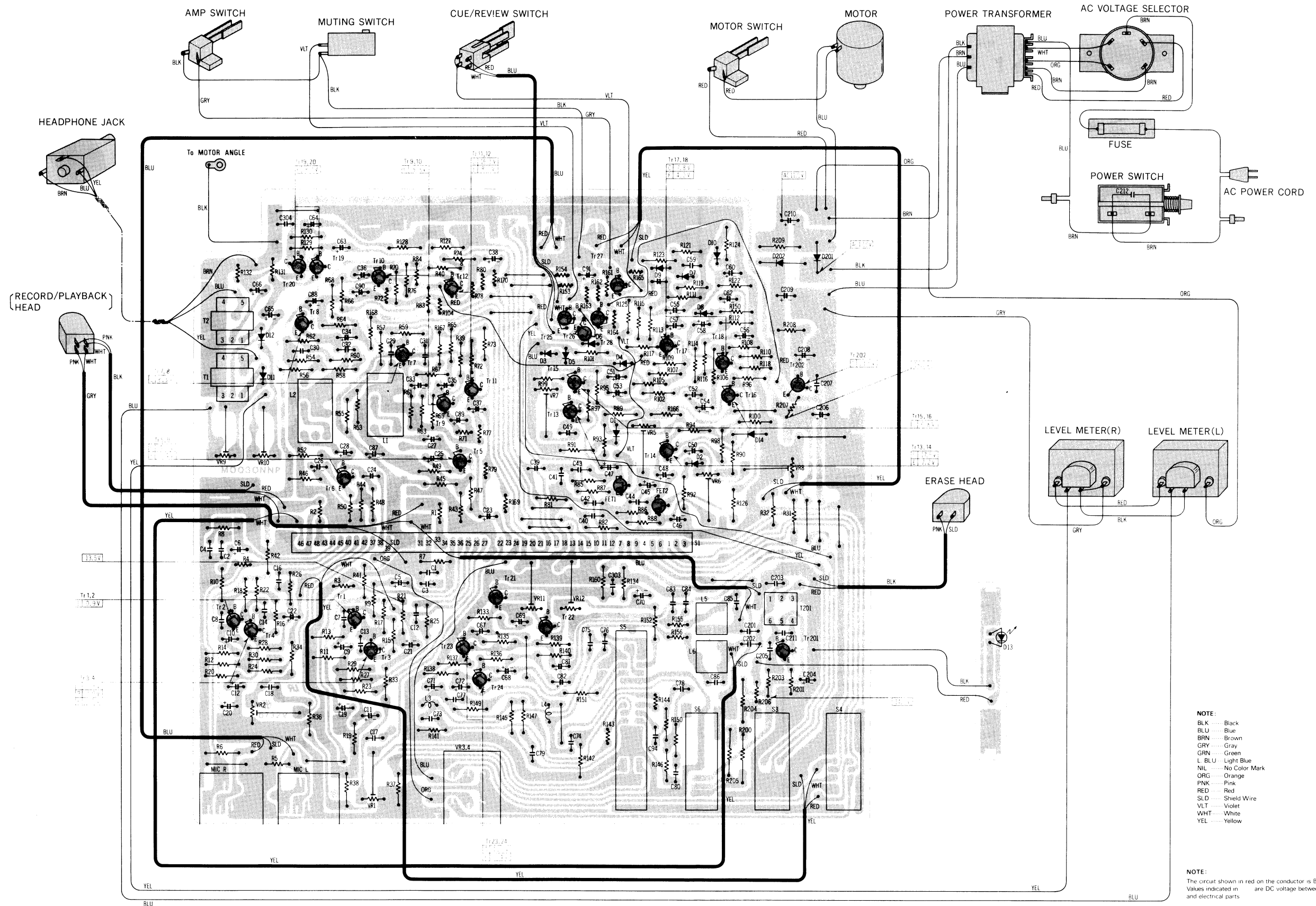

EXPLODED VIEWS

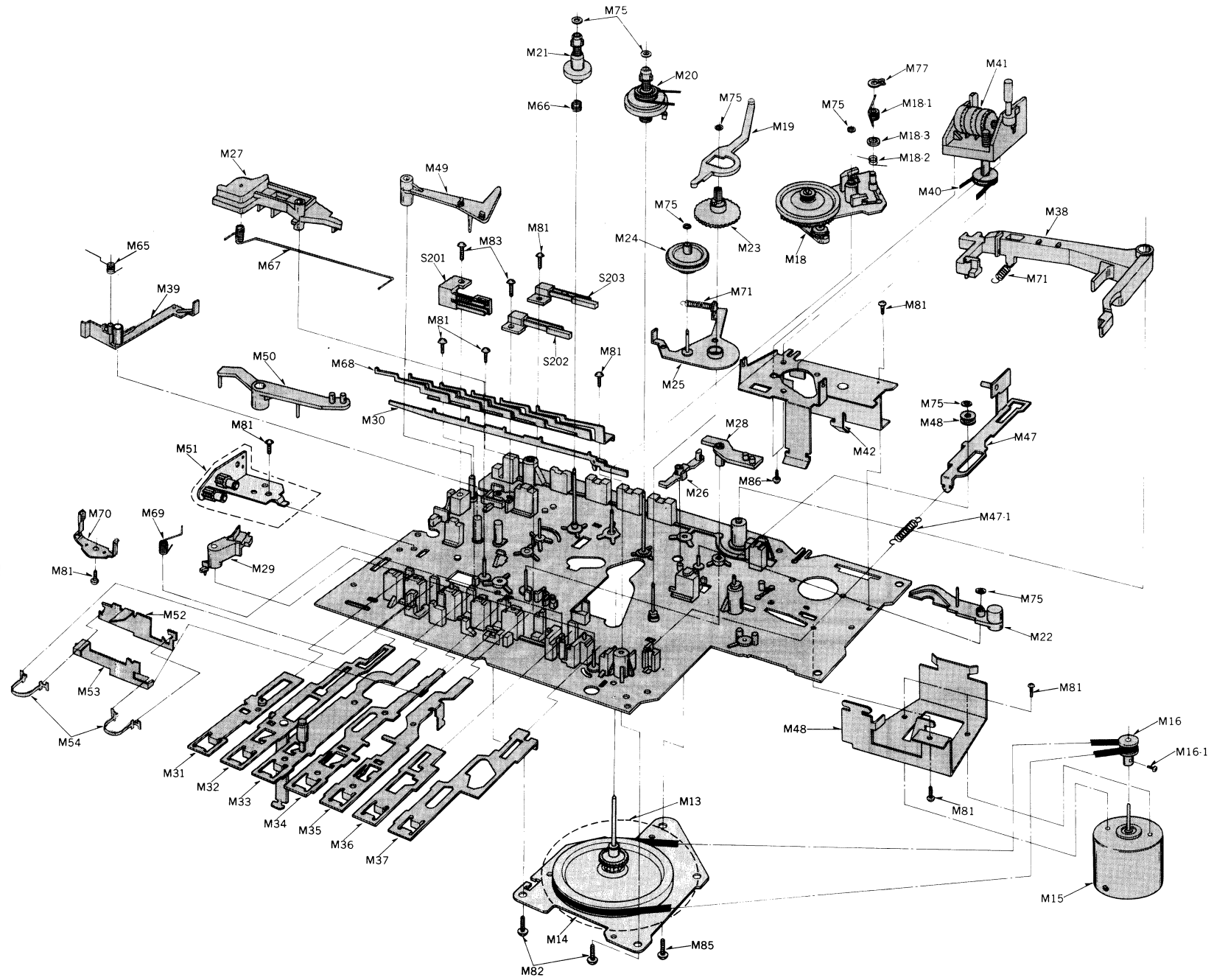
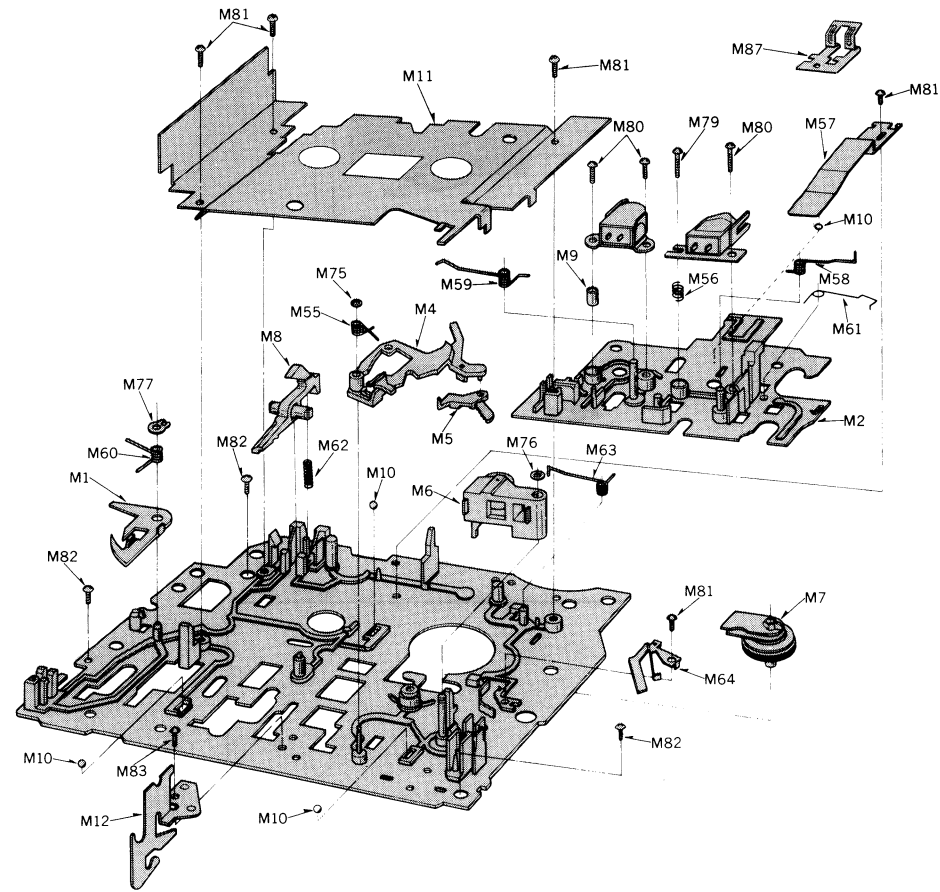

Ref. No.	Part No.	Part Name & Description	Ref. No.	Part No.	Part Name & Description	Ref. No.	Part No.	Part Name & Description
MECHANICAL PARTS								
M1	QML2898	Pause Lock Plate	M25	QXL1037	Gear Lever Assembly	M55	QBN1515	Connection Spring
M2	QMK1612	Head Base Plate	M26	QML3042	Auto-Stop Obstruction Lever	M56	QBC1278	Head Spring
M4	QML3047	Obstruction Lever	M27	QML3217	Pause Lever	M57	QBP1773	Head Base Plate Pressure Spring
M5	QML3048	Driving Lever	M28	QML3049	Cue Lever	M58	QBN1488	Pressure Roller Spring
M6	QXL1057	Pressure Roller Lever Assembly	M29	QML3124	Lock Release Arm	M59	QBN1481	Playback Spring
M7	QXI0098	Takeup Idler Assembly	M30	QXR0275	Lock Rod Assembly	M60	QBN1480	Pause Lock Spring
M8	QML3051	Erase Safety Lever	M31	QXR0342	Pause Rod Assembly	M61	QBN1514	Timer Spring
M9	QMC0061	Erase Head Spacer	M32	QXR0343	Record Rod Assembly	M62	QBC1193	Safety Lever Spring
M10	QDK1012	Steel Ball 2.5φ	M33	QXR0344	Playback Rod Assembly	M63	QBN1513	Idler Spring
M11	QXH0289	Chassis Cover-A	M34	QMR1624	Rewind Rod-A	M64	QBP1723	Click Spring
M12	QMA3169	Fulcrum Angle	M35	QMR1623	Fast Forward Rod-A	M65	QBN1574	Brake Spring
M13	QXF0131	Flywheel	M36	QMR1622	Stop Rod-A	M66	QBC1279	Back Tension Spring
M14	QXH0272	Flywheel Retainer Assembly	M37	QMR1621	Eject Rod-A	M67	QBN1555	Pause Spring
M15	MHI5R9CHY	Motor	M38	QML3038	Switch Arm	M68	QBP1664	Operation Rod Spring
M16	QXP0572	Motor Pulley Assembly	M39	QML3287	Brake Lever	M69	QBN1531	Lock Release Arm Spring
M16-1	XSN2+3	Screw φ2×3	M40	QDB0240	Counter Belt	M70	QBP1662	Lock Rod Spring
M17	QDB0241	Flywheel Belt	M41*	QXC0017	Tape Counter	M71	QBT1682	Lock Holding Spring
M18	QXL1136	Fast Forward Arm Assembly	M42	QMA3171	Counter Angle	M75	QBW2008	Snap Washer
M18-1	QBN1517	Fast Forward Spring	M47	QXR0403	Eject Rod-B	M76	QBW2046	"
M18-2	QBN1559	Fast Forward Arm Spring	M47-1	QBT1619	Idler Spring	M77	XUB4FT	Stop Ring C4φ
M18-3	QMC0080	Collar	M48	QMA3414	Motor Angle	M79	QH01226	Screw
M19	QML3040	Cam Lever	M49	QML3206	Muting Arm	M80	XSN2+10	Screw φ2×10
M20	QXD0067	Takeup Reel Table Assembly	M50	QML3207	Muting Lever	M81	XTN26+5B	Tapping Screw φ2.6×5
M21	QXD0084	Supply Reel Table Assembly	M51	QXG1031	Damper Gear Assembly	M82	XTN3+10B	Tapping Screw φ3×10
M22	QXL1055	Auto-Stop Lever Assembly	M52	QMR1628	Obstruction Rod-A	M83	XTN26+8B	Tapping Screw φ2.6×8
M23	QDG1096	Cam Gear	M53	QMR1629	Obstruction Rod-B	M84	XSN26+3	Screw φ2.6×3
M24	QXG1026	Auto-Stop Gear Assembly	M54	QBP1770	Obstruction Rod Spring	M85	XTN3+25B	Tapping Screw φ3×20
						M86	XSN3+5S	Screw φ3×5
						M87	QBP1807	Cassette Retainer Spring

15 "※" in indicates that QXC0017 is used for the set with marking of black paint on the counter angle.