

Service Manual

Technics

HI-FI COMPONENTS

Technics

FM/AM
4 CHANNEL/2 CHANNEL RECEIVER

MODEL SA-6000X



TECHNICAL SPECIFICATIONS (IHF) Specifications are subject to change without notice for further improvement

AUDIO SECTION

Music power:	4 ch. operation	140W (4Ω)
	Balanced transformerless operation	140W (8Ω)
1 kHz continuous (RMS) power:		
4 ch. operation	Each ch. driven	27W/27W/27W/27W (4Ω)
	All ch. driven	18W/18W/18W/18W (8Ω)
		16W+16W+16W+16W (4Ω)
		14W+14W+14W+14W (8Ω)
2CH Balanced transformerless operation		
Each ch. driven		50W/50W (8Ω)
Both ch. driven		35W+35W (8Ω)
20 Hz~20 kHz continuous (RMS) power:		
4 ch. operation	All ch. driven	10W+10W+10W+10W (8Ω)
	Balanced transformerless operation	30W+30W (8Ω)
Both ch. driven		
Total harmonic distortion:		0.5%
Intermodulation Distortion (60 Hz: 7 kHz: 4:1, SMPTE)		0.7%
Power bandwidth: All ch. driven at 8Ω		7 Hz~30 kHz, -3dB
Frequency response:	PHONO	RIAA standard curve ±1dB
	AUX	8 Hz~50 kHz, +0, -3dB
Residual hum & noise:		1.5 mV
Input sensitivity & impedance:	PHONO	1.5 mV/50 kΩ
	AUX	150 mV/60 kΩ
	PLAYBACK	150 mV/60 kΩ
	MIC	2 mV/50 kΩ
S/N (IHF, A):	PHONO	70 dB
	AUX	90 dB
Tone control:	BASS	50 Hz, +13 dB -13 dB
	TREBLE	10 kHz, +10 dB, -10 dB
Loudness control (Volume at -30 dB):		50 Hz, +10 dB
REC OUT:		150 mV
Damping factor:		30 (8Ω)

Load impedance: 4 CH Balanced Transformerless 4~16Ω 8~16Ω

FM TUNER SECTION

Frequency range:	88~108 MHz
FM sensitivity (IHF):	1.9 μV
Alternate channel selectivity:	65 dB
Harmonic distortion:	MONO 0.3%
	STEREO 0.4%
S/N:	65 dB
Frequency response:	20 Hz~13 kHz, ±1 dB
Image rejection (at 98 MHz):	55 dB
IF rejection (at 98 MHz):	60 dB
Spurious response rejection (at 98 MHz):	60 dB
Capture ratio:	1.8 dB
AM suppression:	50 dB
Stereo separation (at 1 kHz):	40 dB
Leak carrier (19 kHz, 38 kHz):	50 dB

AM TUNER SECTION

Frequency range:	520~1610 kHz
Sensitivity:	20 μV
Selectivity:	25 dB
Image rejection (at 1000 kHz):	40 dB
IF rejection (at 1000 kHz):	40 dB

GENERAL

Power consumption:	300W
Power supply:	AC 50/60 Hz, 110/120/220/240V
Dimensions (W x H x D):	430 x 146 x 385 mm (16 1/2" x 5 3/4" x 15 1/2")
Weight:	11.1 kg (24.5 lb.)

TECHNISCHE DATEN (DIN 45 500) Spezifikationen können infolge von Verbesserungen ohne Ankündigung geändert werden.

VERSTÄRKERTEIL

Musikleistung:	4-Kanal Betrieb	4 x 35W (4Ω)
	Transformatorlos Ausgeglichen Betrieb	2 x 70W (8Ω)
Nennleistung 1 kHz:		
4-Kanal Betrieb Alle Kanäle in Betrieb	4 x 16W (4Ω)	4 x 14W (8Ω)
Transformatorlos Ausgeglichen Betrieb Beide Kanäle in Betrieb	2 x 35W (8Ω)	
Nennleistung 20 Hz~20 kHz:		
4-Kanal Betrieb Alle Kanäle in Betrieb	4 x 12W (4Ω)	4 x 10W (8Ω)
Transformatorlos Ausgeglichen Betrieb Beide Kanäle in Betrieb	2 x 30W (8Ω)	
Harmonische Verzerrung:		0.5%
Nennleistung, bei 1000 Hz 4Ω		0.7%
Intermodulationsverzerrung: Nennleistung, bei 250 Hz: 8000 Hz=4:1		0.7%
Leistungsbandbreite (Alle Kanäle in Betrieb 4Ω):		7 Hz~40 kHz, -3 dB
Frequenzgang:		10 Hz~50 kHz, -3 dB
Eingangs-Empfindlichkeit und-Impedanz:	PHONO	1.5 mV/50 kΩ
	AUX	150 mV/60 kΩ
	MIC	2 mV/50 kΩ
	PLAYBACK	150 mV/60 kΩ
	REC OUT	150 mV
Tonband-Cinchbuchse:		
Fremdspannungsabstand:	PHONO	60 dB
bei Nennleistung	AUX	78 dB
bei 50 mW Ausgangsleistung	PHONO	60 dB
	AUX	60 dB
Klangregler:	Tiefen-Bereich	+13 dB, -13 dB bei 50 Hz
	Höhen-Bereich	+10 dB, -10 dB bei 10 kHz
Loudness-Regler:		50 Hz, +10 dB
Dämpfungsfaktor:		15 bei 4Ω 30 bei 8Ω
Ausgänge Lautsprecher:	4-Kanal Betrieb	4~16Ω
	Transformatorlos Ausgeglichen Betrieb	8~16Ω

Antennenanschluss: 300Ω (symmetrisch) 75Ω (unsymmetrisch)

Empfindlichkeit (bei ±40 kHz Hub): 1.8 μV, 30 dB Fremdspannungsabstand 300Ω 1.5 μV, 20 dB Fremdspannungsabstand 300Ω 1.0 μV, 20 dB Fremdspannungsabstand 75Ω

Klirrfaktor (bei -40 kHz Hub): MONO 0.3% STEREO 0.7%

Fremdspannungsabstand: MONO 52 dB STEREO 50 dB

Selektivität bei 400 kHz: 65 dB

Spiegelselektion (bei 98 MHz): 55 dB

ZF-Festigkeit (bei 98 MHz): 60 dB

Verzerrungsfestigkeit (bei 98 MHz): 60 dB

Gleichwellen-Selektion: 1.8 dB

AM-Unterdrückung: 50 dB

Stereo-Übersprechdämpfung: 40 dB bei 1 kHz

Pilotton-Unterdrückung: 48 dB bei 19 kHz 58 dB bei 38 kHz

Begrenzung, Einsatzpunkt: 1.2 μV

Bandbreite: ZF-Verstärker 350 kHz UKW-Demodulator 700 kHz

MW TUNERTEIL

Empfangsbereich: 520~1610 kHz

Empfindlichkeit: 20 μV

Selektivität: 25 dB

Spiegelselektion: 40 dB

ZF-Festigkeit: 40 dB

ALLGEMEIN

Leistungsaufnahme: 300W

Netzspannung umschaltbar: AC 50/60 Hz, 110/120/220/240V

Abmessungen (B x H x T): 430 x 146 x 385 mm

Gewicht: 11.1 kg

LOCATION OF CONTROLS

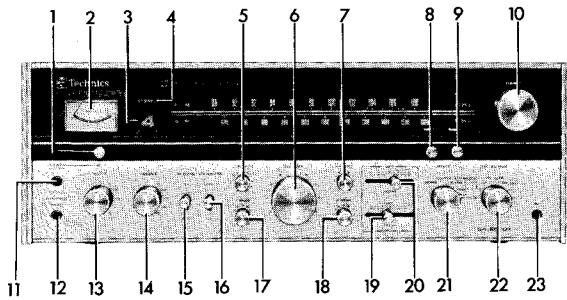

1. POWER SOURCE SWITCH (S8)
2. SIGNAL STRENGTH METER
3. CHANNEL INDICATOR
4. FM STEREO INDICATOR
5. LEFT FRONT LEVEL CONTROL (VR3)
6. MAIN VOLUME CONTROL (VR601)
7. RIGHT FRONT LEVEL CONTROL (VR4)
8. 4CH TAPE MONITOR SWITCH TAPE 1 (S3)
9. 4CH TAPE MONITOR SWITCH TAPE 2 (S4)
10. TUNING CONTROL
11. HEADPHONES JACK Front Channel
12. HEADPHONES JACK Rear Channel
13. BASS CONTROL (VR602)
14. TREBLE CONTROL (VR603)
15. MUTING SWITCH (S6)
16. LOUDNESS SWITCH (S7)
17. LEFT REAR LEVEL CONTROL (VR5)
18. RIGHT REAR LEVEL CONTROL (VR6)
19. AFD (DEPTH) CONTROL (VR2)
20. AFD (WIDTH) CONTROL (VR1)
21. MODE SWITCH (S2)
22. SELECTOR SWITCH (S1)
23. MICROPHONE JACK

24. PHONO INPUT TERMINALS 2 Channel
25. AUX 1 INPUT TERMINALS 4 Channel
26. AUX 2 INPUT TERMINALS 4 Channel
27. 4CH TAPE MONITOR TERMINALS TAPE 1
28. 4CH TAPE MONITOR TERMINALS TAPE 2
29. BALANCED TRANSFORMER LESS SWITCH (S5)
30. RIGHT CHANNEL CIRCUIT PROTECTION FUSES
31. LEFT CHANNEL CIRCUIT PROTECTION FUSES
32. EXT FM ANTENNA TERMINALS
33. EXT AM ANTENNA TERMINAL
34. GROUND TERMINAL
35. 4CH MPX OUTPUT TERMINAL
36. 4CH REMOTE BALANCER CONNECTION SOCKET
37. SPEAKER TERMINALS
38. AC POWER OUTLET Switched
39. AC POWER OUTLET Unswitched
40. VOLTAGE SELECTOR SWITCH (S9)

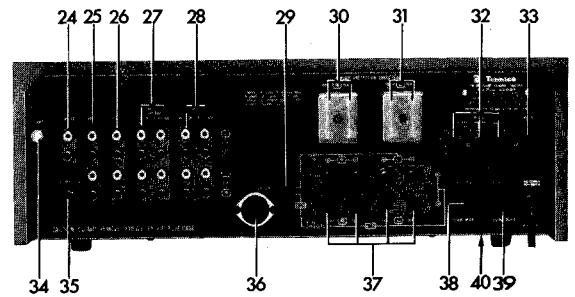

ALIGNMENT INSTRUCTIONS

Alignment Points

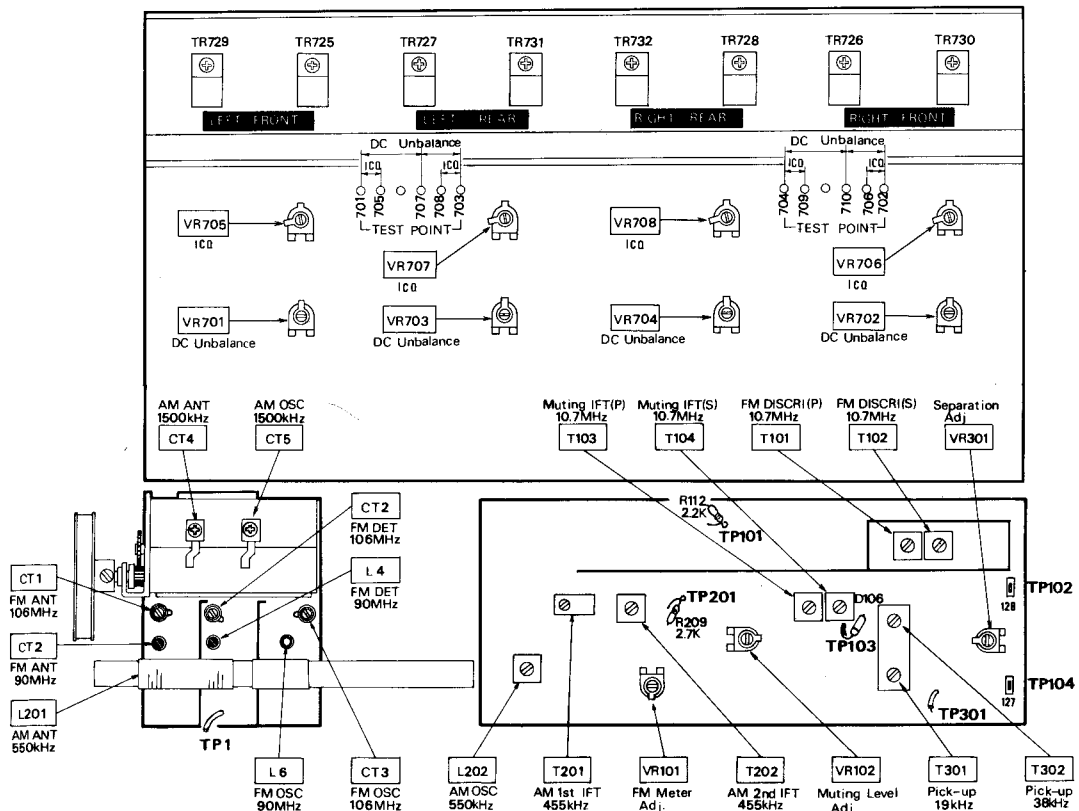

ALIGNMENT INSTRUCTIONS.....READ CAREFULLY BEFORE ATTEMPTING ALIGNMENT

Notes :

- | | |
|--|--|
| 1. Volume control Minimum | 5. The adjustment should be started 1~2 minutes after setting the power switch to the ON position. |
| 2. Balanced transformer less switch..... 4CH | 6. Before adjusting, Icq adjusting volumes (VR805, VR806, VR807 and VR808) as shown in Alignment Point Location. |
| 3. Other controls Optional position | |
| 4. Maintain line voltage at rated voltage. | |

CIRCUIT	VTVM CONNECTION	ADJUSTMENT POINTS	REMARKS
MAIN AMP ALIGNMENT			
1	DC Unbalance Connect DC VTVM to TP702 and TP710 (R-Front) , TP701 and TP707 (L-Front) terminal. Connect DC VTVM to TP704 and TP710 (R-Rear) , TP703 and TP707 (L-Rear) terminal.	VR702 (R-Front) VR701 (L-Front) VR704 (R-Rear) VR703 (L-Rear)	Make sure that DC VTVM becomes 0mV.
2	Icq Connect DC VTVM to TP702 and TP706 (R-Front) , TP701 and TP705 (L-Front) terminal. Connect DC VTVM to TP704 and TP709 (R-Rear) , TP703 and TP708 (L-Rear) terminal.	VR706 (R-Front) VR705 (L-Front) VR708 (R-Rear) VR707 (L-Rear)	Make adjustments so that the indication on DC VTVM becomes 4 mV.

Notes :

- | | |
|---|--|
| 1. Volume control Maximum (AM-RF)
Minimum (AM-IF, FM-IF)
Variable (FM-RF) | 5. Muting switch OFF |
| 2. Bass and treble control Center | 6. Balanced transformer less switch..... 4CH |
| 3. Band selector switch AM | 7. Tape-monitor switch Source |
| 4. Loudness switch OFF | 8. Mode switch Stereo |
| | 9. Maintain line voltage at rated voltage. |
| | 10. Output of signal generator should be no higher than necessary to obtain an output reading. |

SIGNAL GENERATOR or SWEEP GENERATOR		RECEIVER DIAL SETTING [DISTANCE]	INDICATOR (VTVM or SCOPE)	ADJUSTMENT POINTS	REMARKS
CONNECTION	FREQUENCY				
AM ALIGNMENT					
3	High side through 0.001μF to antenna terminal, Common to chassis.	455 kHz (20 kHz Sweep)	Point of non-interference	Connect vert. amp. of scope to TP201 .	T201 (1st IFT) T202 (2nd IFT) Adjust for maximum output.
4	Fashion loop of several turns of wire and radiate signal into loop of receiver.	550 kHz (30% Mod. with 400Hz)	550 kHz [5.5mm (3/16")]	Connect meter to speakers terminal of set.	L202 (OSC Coil) L201 (ANT Coil) Adjust for maximum output. Adjust L201 by moving coil bobbin along ferrite core.
5	Fashion loop of several turns of wire and radiate signal into loop of receiver.	1500 kHz (30% Mod. with 400 Hz)	1500 kHz [157.2mm (6 3/16")]	Connect meter to speakers terminal of set.	CT5 (OSC Trimmer) CT4 (ANT Trimmer) Adjust for maximum output. Repeat steps (4) and (5).

FM-IF ALIGNMENT

6			Point of non-interference.	Connect DC VTVM between TP102 and TP104 .	T102 (FM DISCRI IFT)(S) Make sure that VTVM becomes 0V.
7	High side through 0.001μF to TP1 . Common to chassis.	10.7 MHz (400kHz Sweep)	Point of non-interference.	Connect vert. amp. of scope through detector to TP101 . Refer to figure 1.	Confirm center frequency.
8	High side through 0.001μF to TP1 . Common to chassis.	10.7 MHz (400kHz Sweep)	Point of non-interference.	Connect vert. amp. of scope to TP103 .	T103 (Muting IFT) (P) T104 (Muting IFT) (S) Adjust for maximum sharp and proper linearity. Adjust to center frequency as step 7. Refer to figure 2.

FM-RF ALIGNMENT

9	Connect to FM antenna terminal through FM dummy antenna. (Refer to fig 3)	90 MHz (100% Mod. with 400 Hz)	90 MHz [20.7mm (7/32")]	Output meter across speaker terminals.	L6 (FM OSC Coil) * L4 (FM DET Coil) L2 (FM ANT Coil) Adjust for maximum output.
10	Connect to FM antenna terminal through FM dummy antenna. (Refer to fig. 3)	106 MHz (100% Mod. with 400 Hz)	106 MHz [147.2mm (5 7/32")]	Output meter across speaker terminals.	CT3 (FM OSC Trimmer) CT2 (FM DET Trimmer) CT1 (FM ANT Trimmer) Adjust for maximum output. Repeat steps(9) and (10).

* Use six cornered alignment tool for aligning FM OSC coil (L6).

MUTING LEVEL ALIGNMENT

Note : Muting switch.....ON

11	Connect to FM antenna terminal through FM dummy antenna.	98 MHz (100% Mod. with 400 Hz) Output 28 dB	98 MHz	Output meter or speaker across speaker terminals.	VR102 (Muting Level) Adjust so that output can be obtained.
----	--	---	--------	---	--

SIGNAL GENERATOR		RECEIVER DIAL	INDICATOR	ADJUSTMENT POINTS	REMARKS
CONNECTION	FREQUENCY	SETTING	(DISTORTION METER and SIGNAL METER)		
FM-MONO DISTORTION ALIGNMENT					
Note: Muting switch OFF					
12	Connect to FM antenna terminal through FM dummy antenna.	98 MHz (100% Mod. with 400 Hz) Output 72 dB	98 MHz	Connect distortion meter to speaker terminals.	T101 (FM DISCRI IFT) (P) Adjust for minimum distortion.
SIGNAL METER ALIGNMENT					
13	Connect to FM antenna terminal through FM dummy antenna.	98 MHz (30% Mod. with 400 Hz) Output 72 dB	98 MHz	Signal meter of set.	VR101 (Indicated Position) Adjust for about 4.6 point of signal meter indication.
Notes: Stereo-modulator Connect stereo-modulator output to EXT. MOD. terminal of signal generator. Internal OSC 1 kHz. Pilot signal modulation 10%. Signal generator Frequency approximately 98 MHz. Output level 72 dB. Modulation mode to FM. 1. Band selector FM-Auto 2. Bass and treble control Center 3. Balanced transformer less switch 4CH 4. Mode switch Stereo 5. Maintain line voltage at rated voltage. 6. Muting switch OFF 7. Loudness switch OFF 8. Tape monitor switch Source 9. Dummy load Source					
19kHz COIL and PHASE ALIGNMENT					
SIGNAL GENERATOR CONNECTION		STEREO MODULATOR MODE and MOD. RATE	INDICATOR (VTVM or SCOPE)	ADJUSTMENT POINTS	REMARKS
14	FM antenna terminal through dummy antenna.	Pilot signal to ON.	Connect scope to TP ₃₀₁ , Common to chassis.	T ₃₀₁ (19 kHz Coil)	Adjust for maximum output.
15	"	L (or R) 30% Mod.	Connect scope to speaker terminals.	T ₃₀₂ (38 kHz Coil) (Phase Alignment)	Adjust for minimum right (or left) output.
SEPARATION ALIGNMENT					
16	FM antenna terminal through dummy antenna.	L (and R) 30% Mod.	Output meter across speaker terminals through low pass filter. (Refer to fig. 4)	VR ₃₀₁ (Separation)	Adjust for minimum right (and left) output.

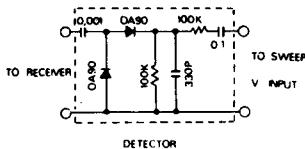

Fig. 1

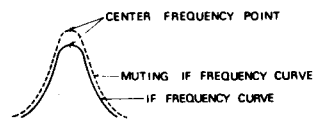

Fig. 2

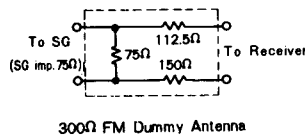

Fig. 3

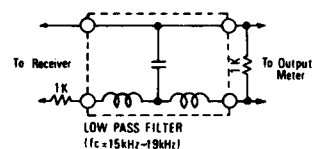

Fig. 4

FM-RF ALIGNMENT INSTRUCTIONS Only set for Germany

ABGLEICHANWEISUNGEN VOR DEM ABGLEICH SORGFÄLTIG DURCHLESEN					
MESSENDER		SKALENZEIGER-EINSTELLUNG DES EMPFÄNGERS [ABSTAND]	ANGEIGE (RÖHRENVOLTMETER ODER OSZILLOGRAPH)	ABGLEICH	BEMERKUNGEN
SCHALTUNG	FREQUENZ				
FM HF-ABGLEICH					
Anschluß an den FM Antennenanschluß über die künstliche FM Antenne. (Vgl. Abb. 1)	87.5 MHz (100% Mod. bei 400Hz)	87.5 MHz { 0mm }	Output meter über Lautsprecher-schwingspule anschließen.	L ₆ (Oszillatorspule)	Auf max. Ausgang abgleichen
"	90 MHz (")	90 MHz	"	L ₄ (Zwischenkreis) L ₂ (Antennenspule)	"
"	106 MHz (")	106 MHz { 147.2mm }	"	CT ₃ (OSZ. Trimmer) CT ₂ (DET. Trimmer) CT ₁ (ANT. Trimmer)	"

Schematic Diagram Model SA-6000X

(This schematic diagram may be modified at any time with the

B-75	B-74	B-73	B-73	B-62	B-62
C-0	C-0	C-0.3	C-0	C-0.2	C-0.2
E-8.2	E-8.2	E-1.7	E-7.7	E-6.8	E-6.8

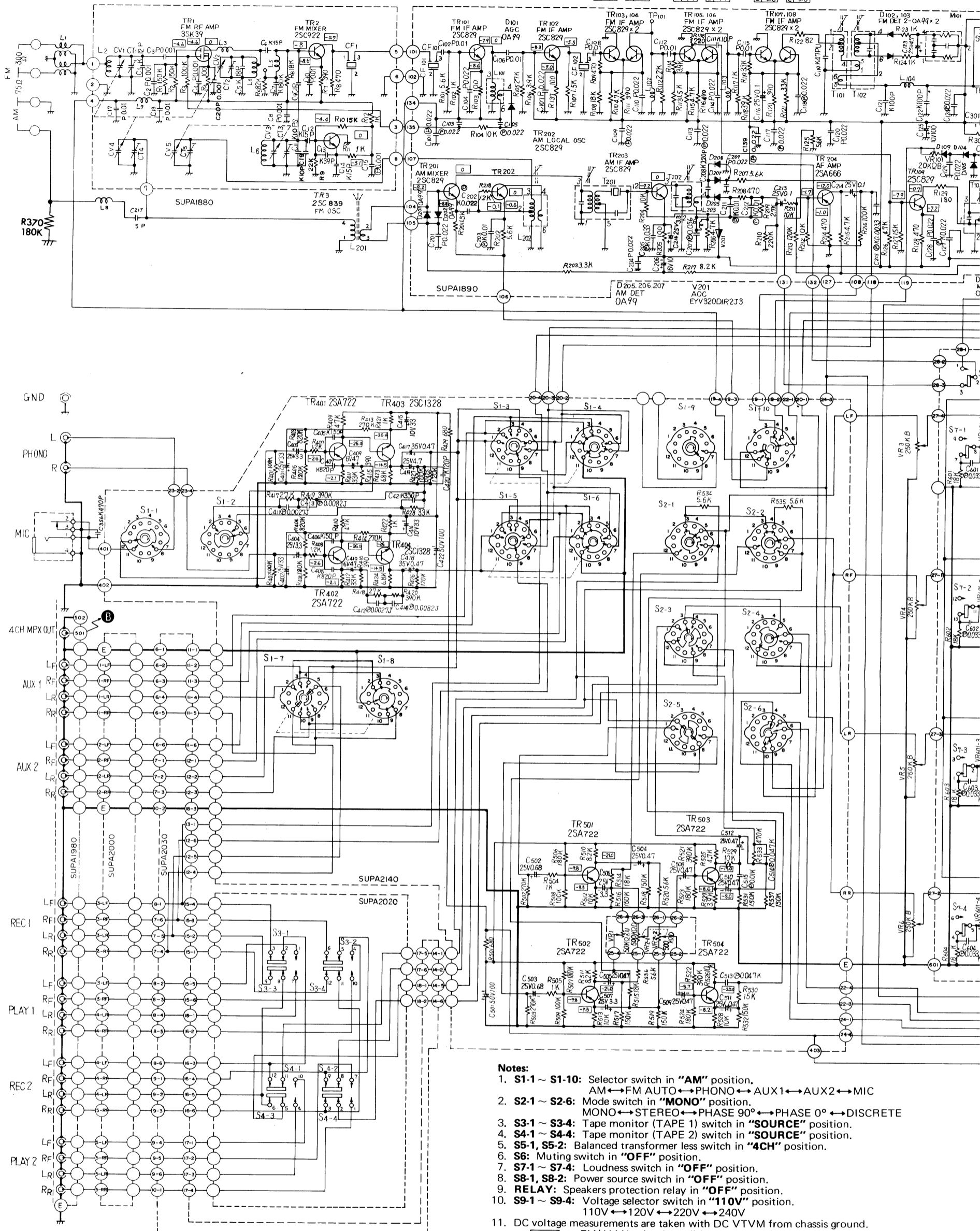

- Notes:**
- S1-1 ~ S1-10: Selector switch in "AM" position.
AM ↔ FM AUTO ↔ PHONO ↔ AUX1 ↔ AUX2 ↔ MIC
 - S2-1 ~ S2-6: Mode switch in "MONO" position.
MONO ↔ STEREO ↔ PHASE 90° ↔ PHASE 0° ↔ DISCRETE
 - S3-1 ~ S3-4: Tape monitor (TAPE 1) switch in "SOURCE" position.
 - S4-1 ~ S4-4: Tape monitor (TAPE 2) switch in "SOURCE" position.
 - S5-1, S5-2: Balanced transformer less switch in "4CH" position.
 - S6: Muting switch in "OFF" position.
 - S7-1 ~ S7-4: Loudness switch in "OFF" position.
 - S8-1, S8-2: Power source switch in "OFF" position.
 - RELAY: Speakers protection relay in "OFF" position.
 - S9-1 ~ S9-4: Voltage selector switch in "110V" position.
110V ↔ 120V ↔ 220V ↔ 240V
 - DC voltage measurements are taken with DC VTVM from chassis ground.
..... FM/AM No signal condition.
..... FM stereo signal reception or FM muting to "ON" position.

- VR1: AFD Control WIDTH
- VR2-1, VR2-2: AFD Control DEPTH
- VR3 ~ VR6: Channel Level Control
- VR101: FM Meter Adjustment
- VR102: FM Muting Level Adjustment
- VR301: Separation Adjustment
- VR601-1 ~ VR601-4: Main Volume Control
- VR602-1 ~ VR602-4: Bass Control
- VR603-1 ~ VR603-4: Treble Control
- VR701 ~ VR704: DC Unbalance Adjustment
- VR705 ~ VR708: ICQ Adjustment

...ied at any time with the development of new technology.)

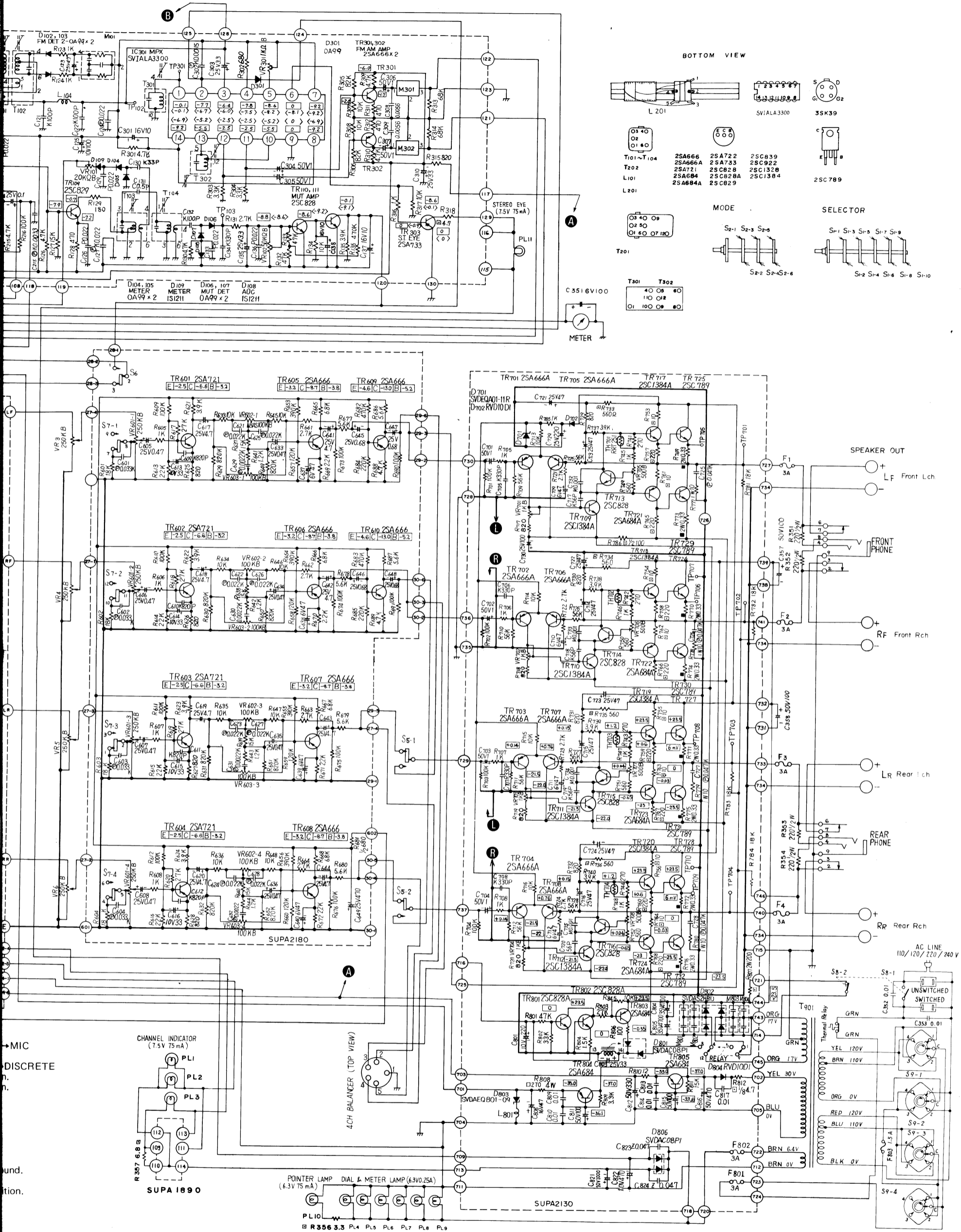

■ LOCATION OF CIRCUIT BOARDS

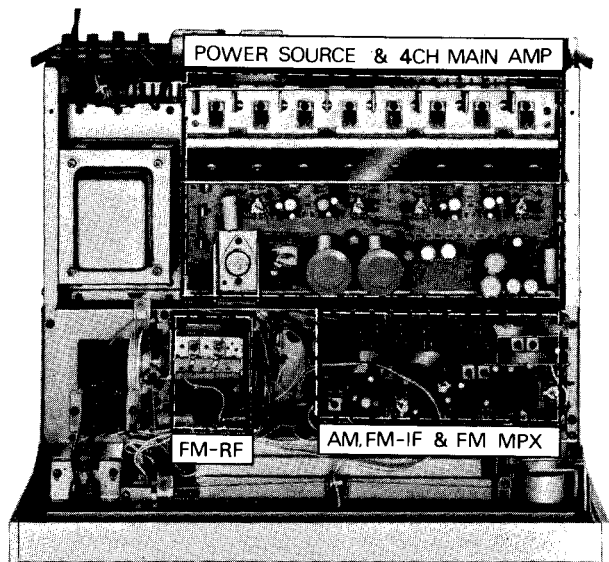

Top View

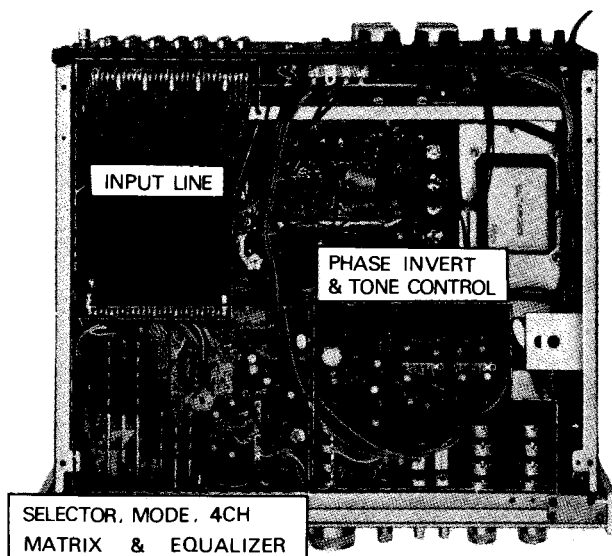

Bottom View

■ TO REMOVE TUNER

1. Remove four (4) cabinet mounting screws.
2. Remove cabinet from chassis.
3. Remove fourteen (14) control knobs from front panel.
4. Remove six (6) front panel mounting black screws. Refer to cabinet and chassis Parts Location on page 13.
5. Remove front panel from chassis.
6. Remove seven (7) tuner mounting black screws, nos. 1~7, as figure 2 and 3.
7. Loosen power switch mounting screws, nos. 8, 9 and slide power switch as figure 3.
8. Then tuner can be moved in front of chassis as figure 1, and remove tuner from chassis.

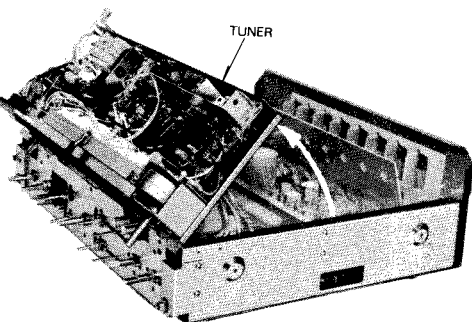

Fig. 1

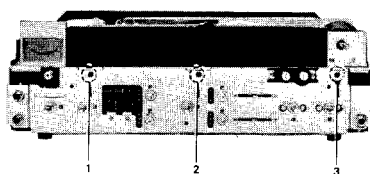

Fig. 2

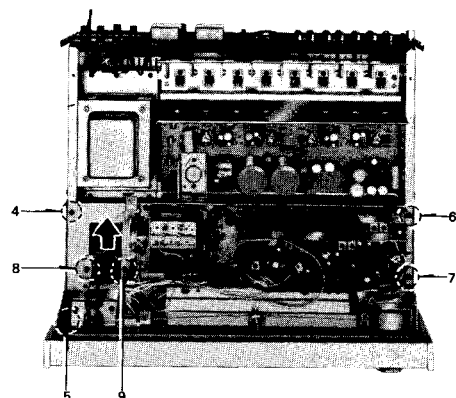
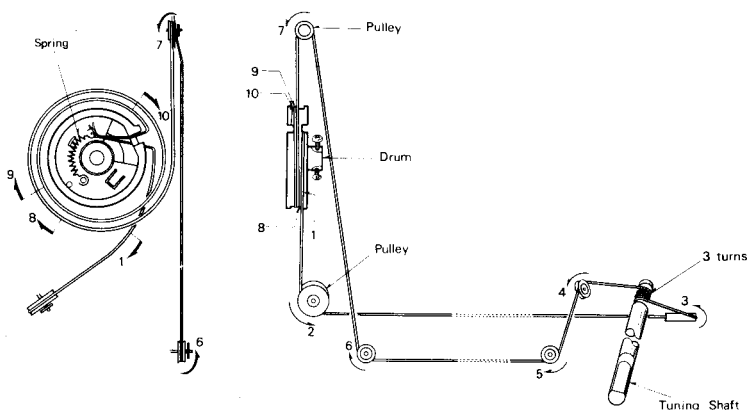

Fig. 3

■ DIAL CORD INSTALLATION GUIDE

1. Dial cord length is 63 1/2" (160cm)
2. Tuning gang is positioned at maximum capacity. (Frequency is minimum)
3. Arrow marks (1 ~ 10) indicate correct order and direction of stringing dial cord.



POWER SOURCE & 4CH MAIN AMPLIFIER Circuit Board

TR722 C -23 V B -0.65V E -0.03V	TR730 C 0 V B -23 V E -23.5V	TR714 C +1.2 V B +0.04V E -0.65V	TR726 C +23.5V B +0.6V E 0 V	TR720 C +23.5V B +1.2V E +0.6V	TR728 C +23.5V B +0.6V E 0 V	TR716 C +1.2 V B +0.04V E -0.65V	TR724 C -23 V B -0.65V E -0.03V	TR732 C 0 V B -23 V E -23.5V	TR723 C -23 V B -0.65V E -0.03V	TR731 C 0 V B -23 V E -23.5V	TR715 C +1.2 V B +0.04V E -0.65V	TR727 C +23.5V B +0.6V E 0 V	TR717 C +23.5V B +1.2V E +0.6V	TR725 C +23.5V B +0.6V E 0 V	TR721 C -23 V B -0.65V E -0.03V	TR713 C +1.2 V B +0.04V E -0.65V	TR729 C 0 V B -23 V E -23.5V
--	---------------------------------------	---	---------------------------------------	---	---------------------------------------	---	--	---------------------------------------	--	---------------------------------------	---	---------------------------------------	---	---------------------------------------	--	---	---------------------------------------

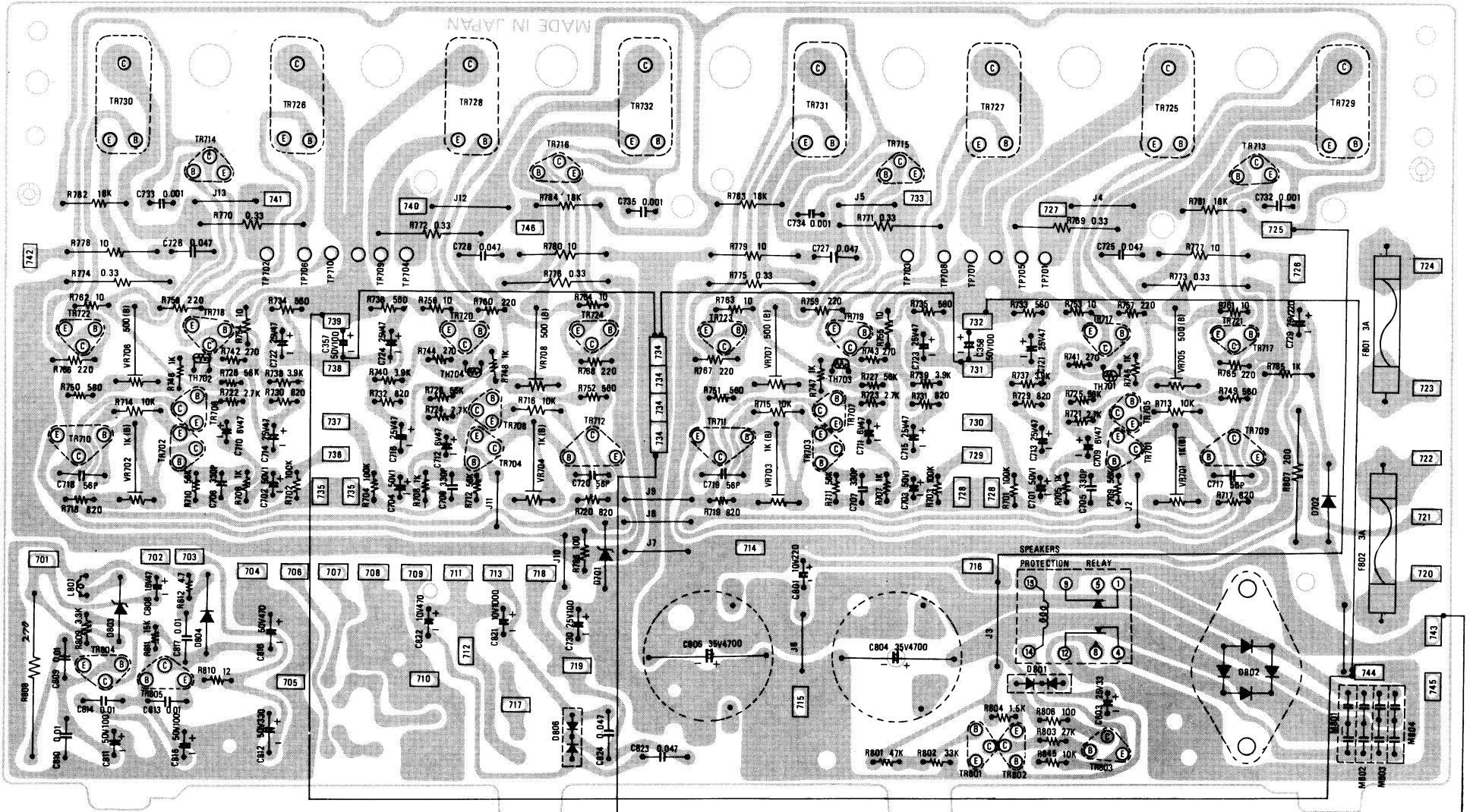

TR710 C -0.65V B -21.5 V E -22 V	TR804 C -37 V B -36.1V E -35 V	TR805 C -37 V B -33.6V E -33 V	TR702 C -21.5 V B +0.14V E +0.76V	TR706 C -22 V B +0.14V E +0.76V	TR718 C +23.5 V B +1.2 V E +0.6 V	TR704 C -21.5 V B +0.14V E +0.76V	TR708 C -22 V B +0.14V E +0.76V	TR712 C -0.65V B -21.5 V E -22 V	TR711 C -0.65V B -21.5 V E -22 V	TR703 C -21.5 V B +0.14V E +0.76V	TR707 C -22 V B +0.14V E +0.76V	TR719 C +23.5V B +1.2V E +0.6V	TR801 C +23.5V B 0 V E 0 V	TR802 C +23.5 V B 0 V E 0 V	TR803 C -0.35V B +23.5 V E +23.5 V	TR701 C -21.5 V B +0.14V E +0.76V	TR705 C -22 V B +0.14V E +0.76V	TR709 C -0.65V B -21.5 V E -22 V
---	---	---	--	--	--	--	--	---	---	--	--	---	-------------------------------------	--------------------------------------	---	--	--	---

SELECTOR/MODE SWITCH. 4 CH MATRIX & EQUALIZER Circuit Board

Bottom View

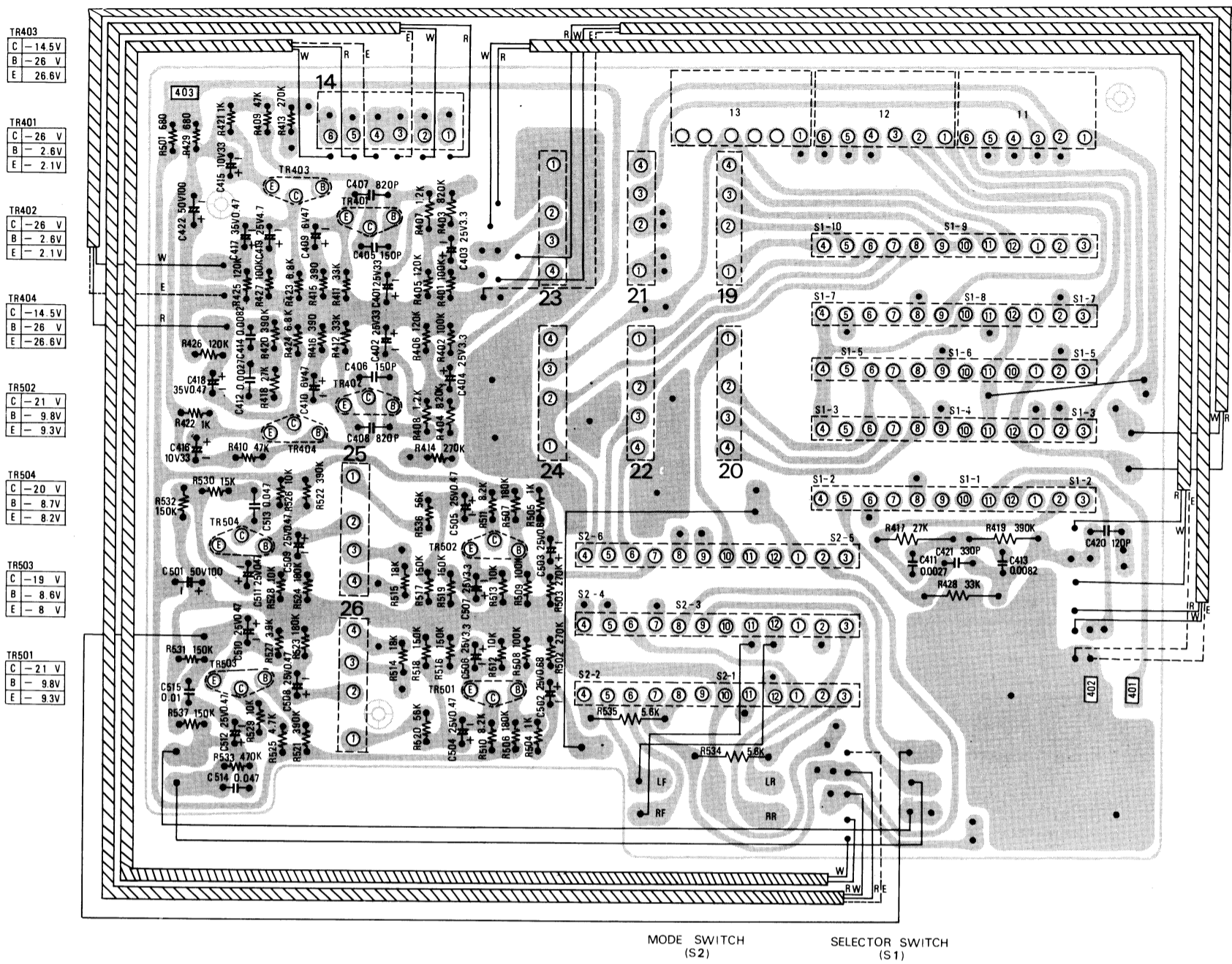

SA-6000X 9-2

INPUT TERMINAL Circuit Board

Bottom View

TAPE MONITOR SWITCH Circuit Board

Bottom View

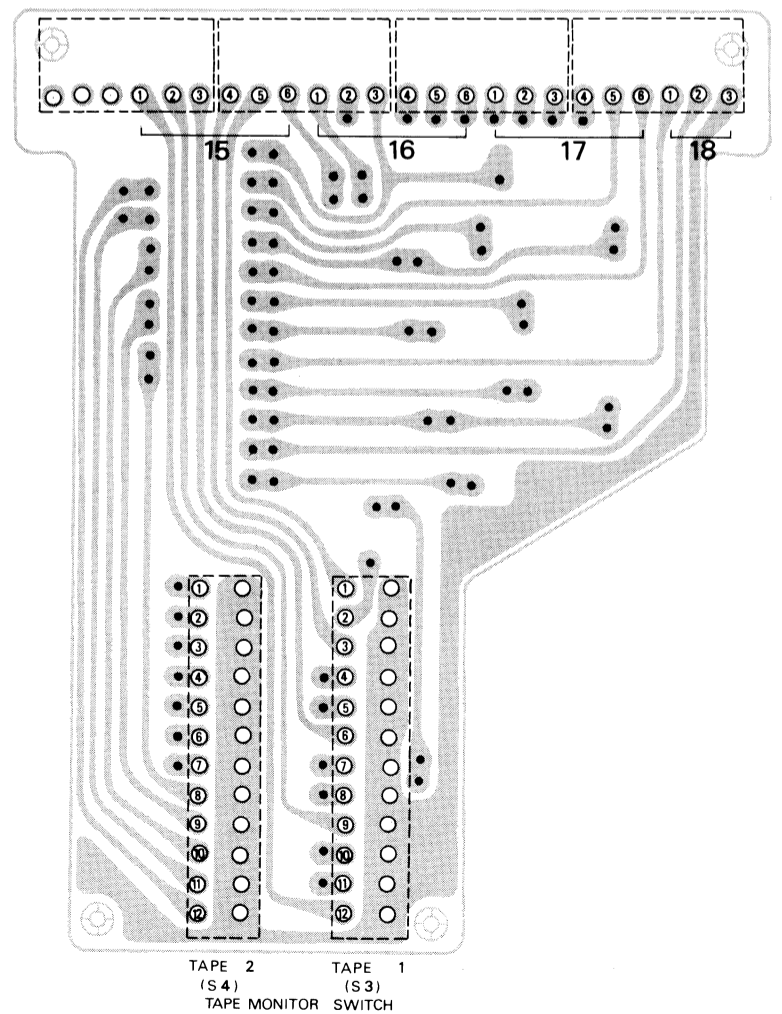
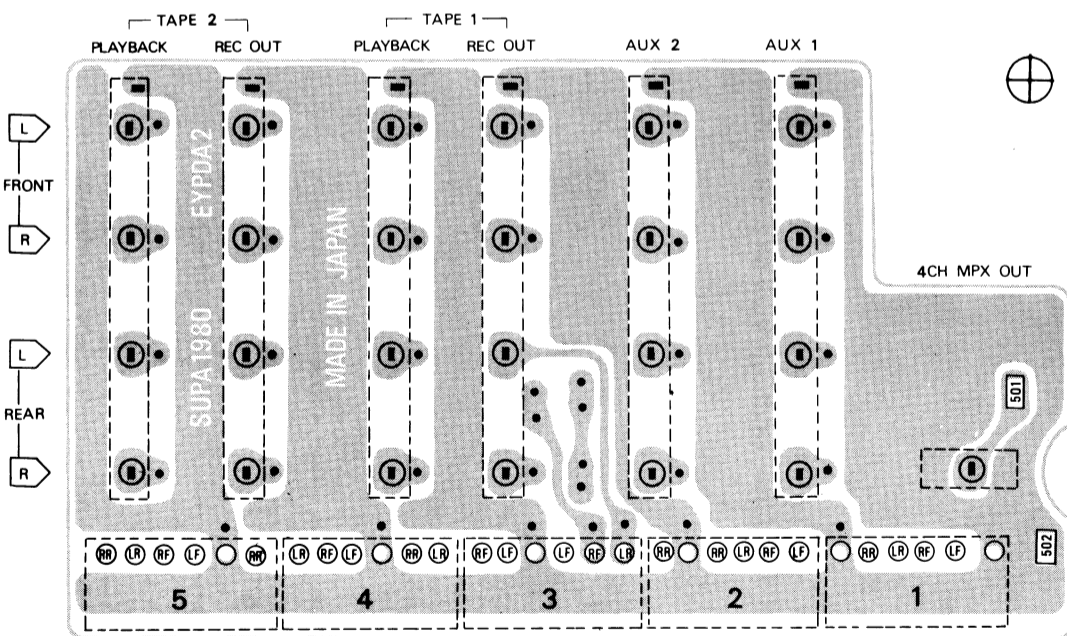

CONNECTING Circuit Board

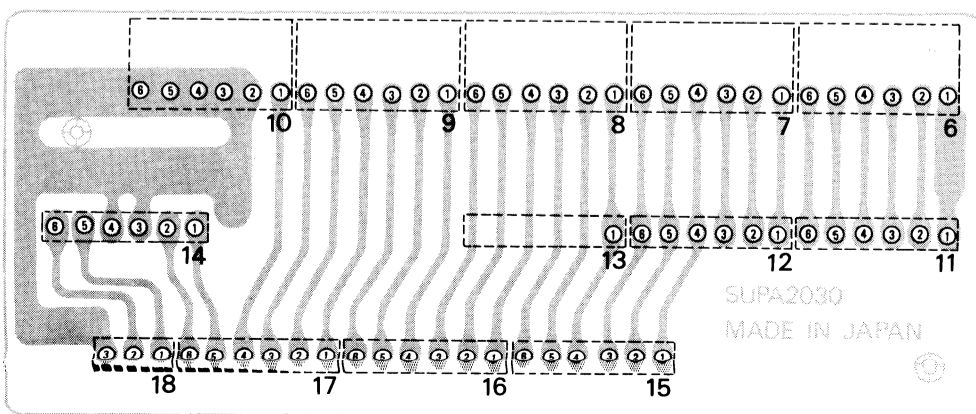

SA-6000X 10-2

PHASE INVERT & TONE CONTROL Circuit Board

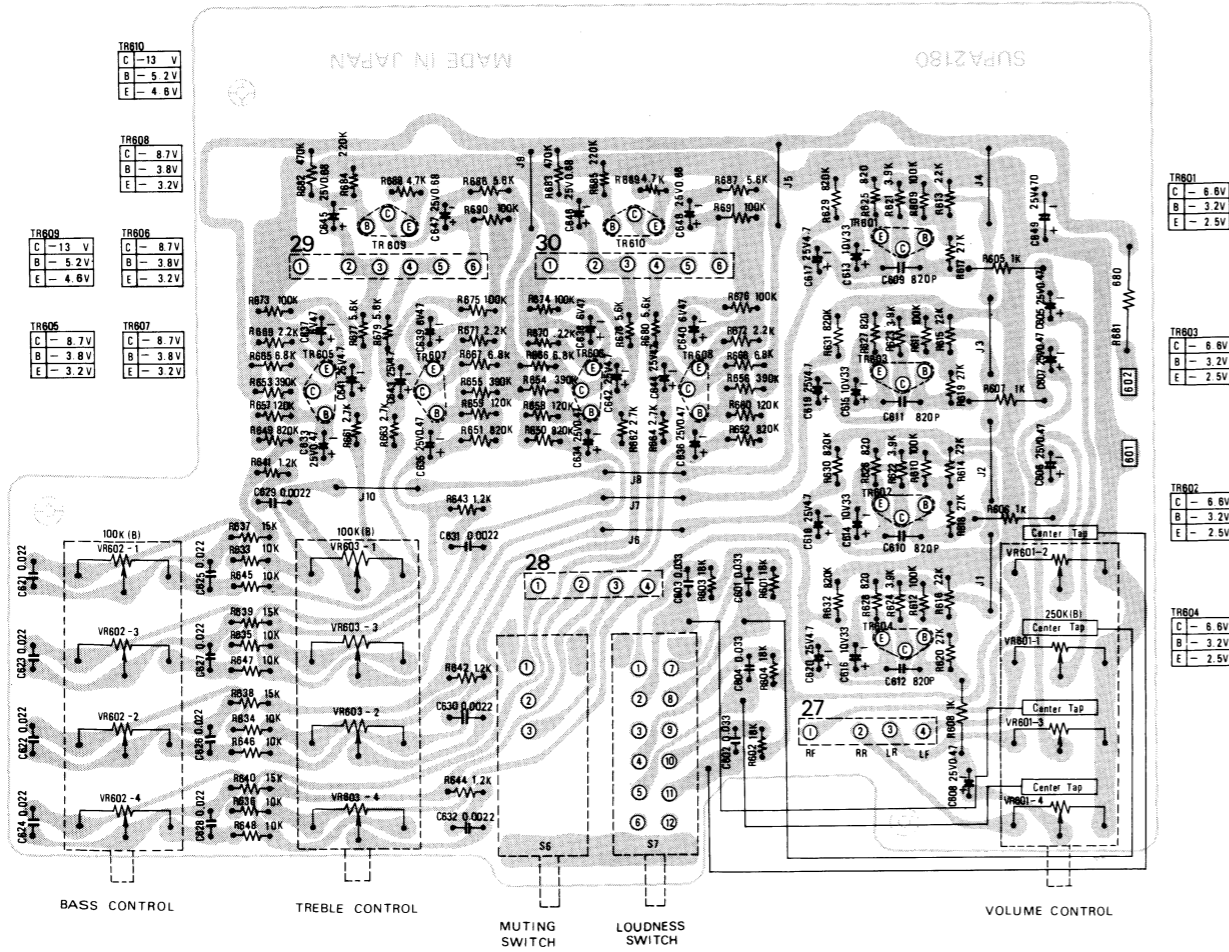

INPUT LINE Circuit Board

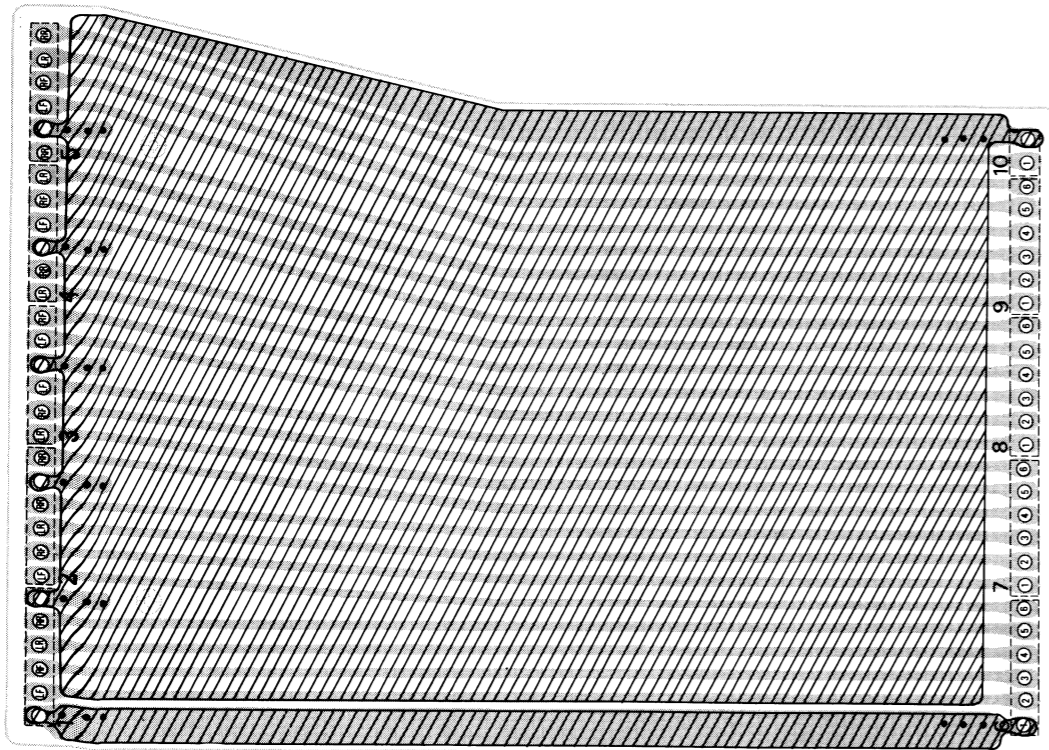

Printed Circuit View on Top of p.c.b.
 Printed Circuit View on Bottom of p.c.b.

AM, FM-IF & FM MPX Circuit Board

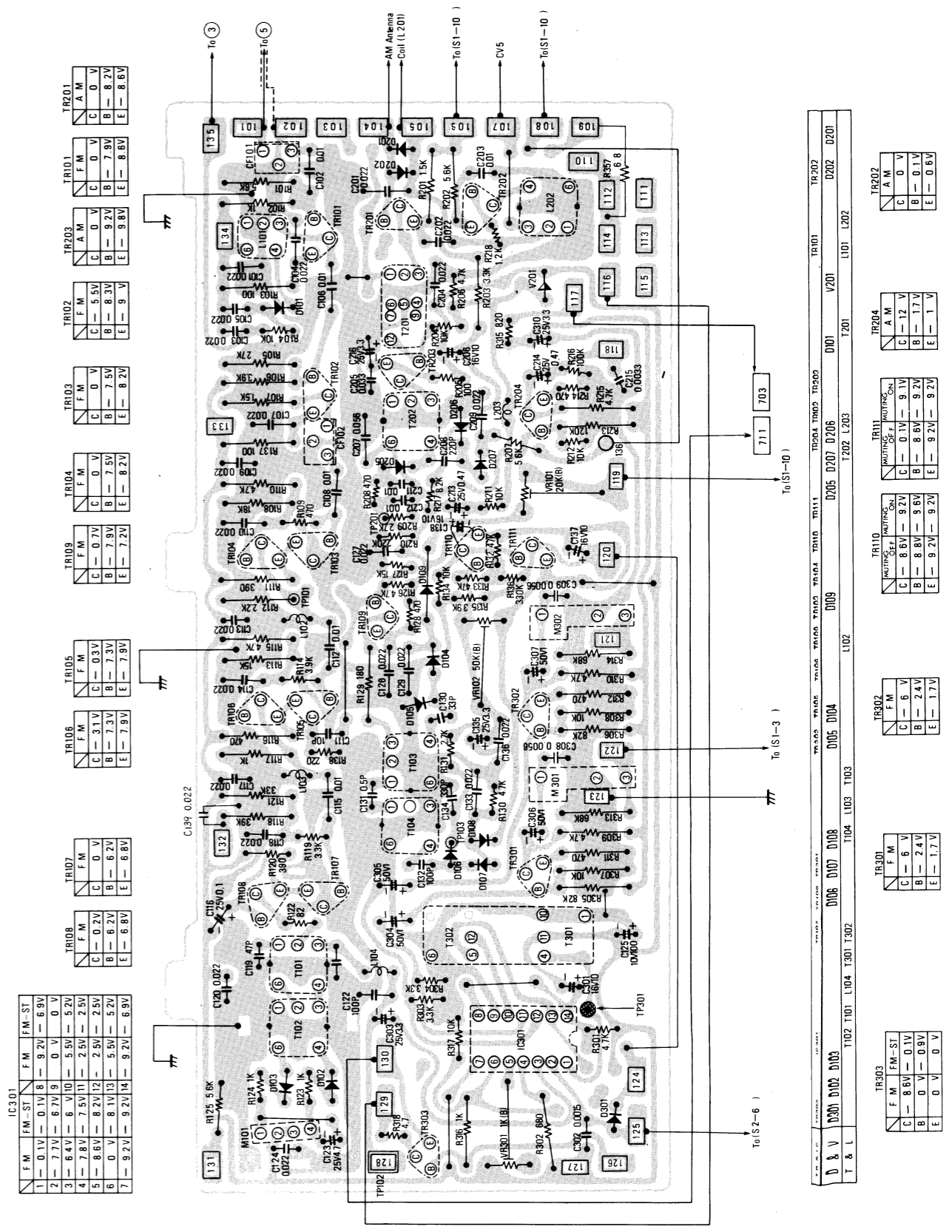

IC301		F.M.	F.M.-ST.	F.M.	F.M.-ST.
1	0.1V	-0.1V	8	-9.2V	-6.9V
2	7.7V	-6.7V	9	0 V	0 V
3	-6.4V	-6 V	10	-5.5V	-5.2V
4	-7.8V	-7.5V	11	-2.5V	-2.5V
5	-8.6V	-8.2V	12	-2.5V	-2.5V
6	0 V	-8.1V	13	-5.5V	-5.2V
7	-9.2V	-9.2V	14	-9.2V	-6.9V

TR201		F.M.	F.M.	F.M.	F.M.
A	0 V	0 V	0 V	0 V	0 V
B	-8.8V	-7.9V	-8.8V	-8.8V	-8.8V
C	0 V	0 V	0 V	0 V	0 V
D	0 V	0 V	0 V	0 V	0 V
E	-8.8V	-9.8V	-9.8V	-9.8V	-9.8V

TR202		F.M.	F.M.	F.M.	F.M.
A	0 V	0 V	0 V	0 V	0 V
B	-8.8V	-9.2V	-8.8V	-8.8V	-8.8V
C	0 V	0 V	0 V	0 V	0 V
D	0 V	0 V	0 V	0 V	0 V
E	-8.8V	-9.2V	-9.2V	-9.2V	-9.2V

FM-RF Circuit Board

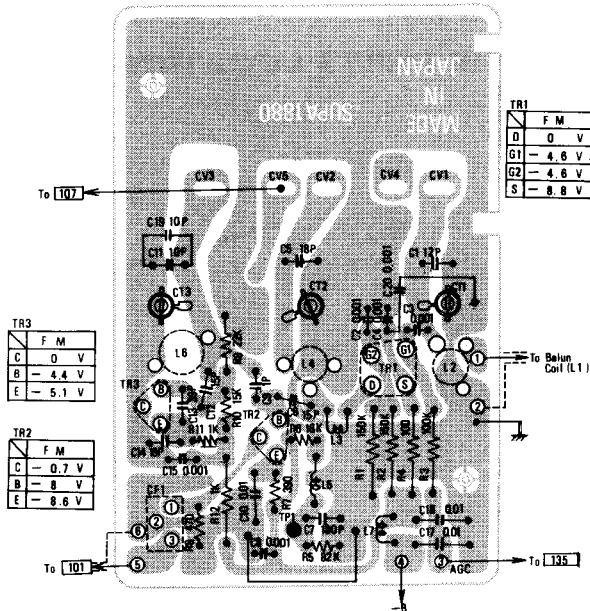

■ SERVICE AID

How to install and remove the connection socket

1. Insert the lead wire into the lead wire pin clamp. (See fig. 1-①)
2. Bend the tabs of the lead wire pin clamp using radio pliers to attach the lead wire. (See fig. 1-② and ③)
3. Insert the lead wire pin clamp, to which the lead wire has been attached, into the connection socket. (See fig. 2)
4. In order to remove the lead wire pin clamp from the connection socket, insert an eyeletter into the socket hole and touch it to the lead wire pin clamp stop. (See fig. 3-①)
5. Bend the stop inward toward the lead wire pin clamp and pull out the lead wire pin clamp. (See fig. 3-②)

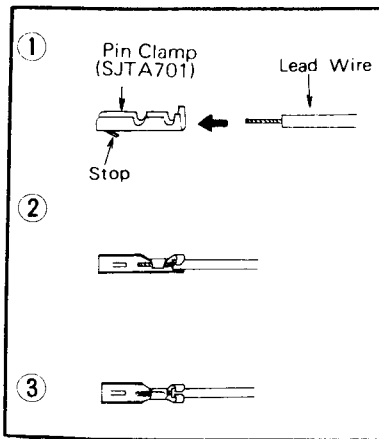

Fig. 1

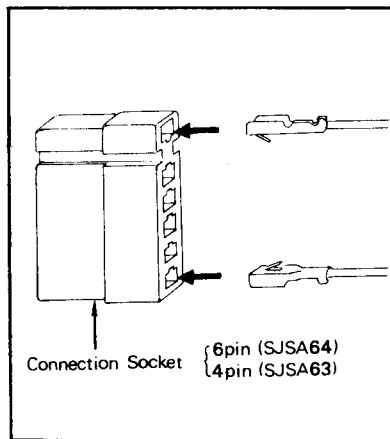

Fig. 2

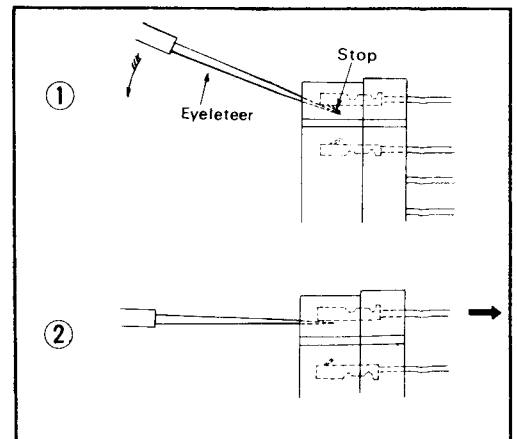
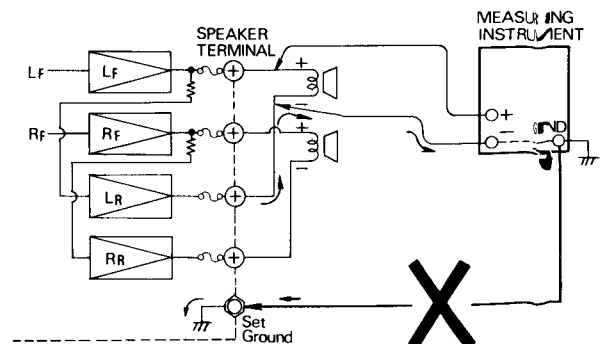
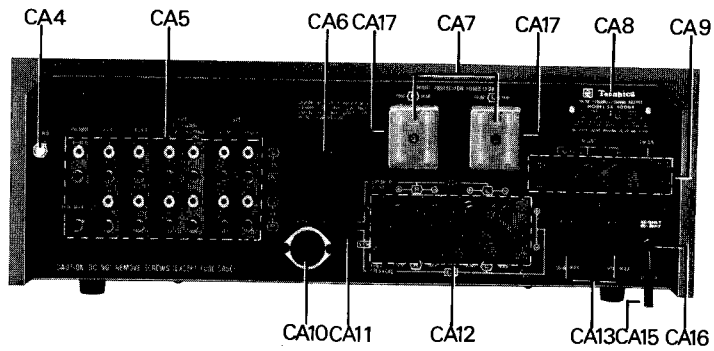
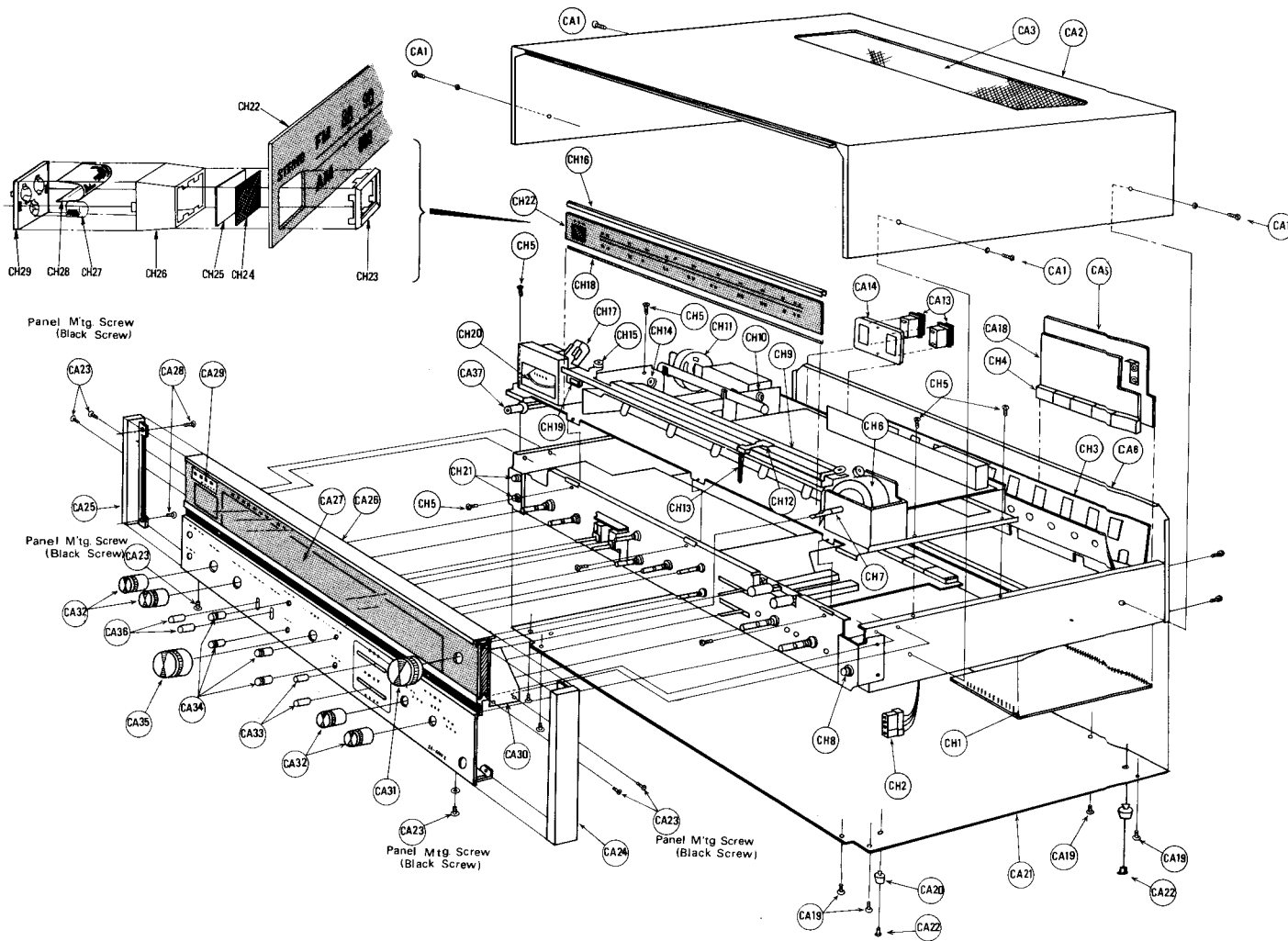

Fig. 3

When the measuring instrument is connected to the speaker terminals with the balanced transformerless connection, the following should be noted: There are some measuring instruments whose ground (GND) terminal is connected directly to the negative side of the input terminal. If the instrument used for measurement is so designed, extreme care should be given that the ground terminal of the instrument not be connected to the ground terminal of the set. If care is not exercised and the connection is made, excessive electric current will flow in the direction of the arrow, as shown in the diagram, causing the rear amplifier to reach a short-circuit condition. When this occurs, the circuit protecting fuse will be blown, interrupting the circuit. Please be careful.



■ CABINET & CHASSIS PARTS LOCATION



■ ACCESSORIES

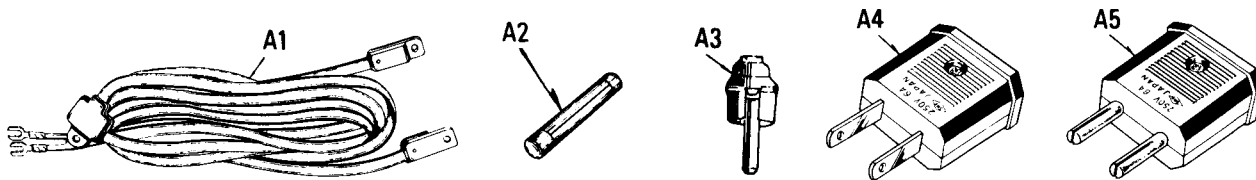

■ PACKINGS

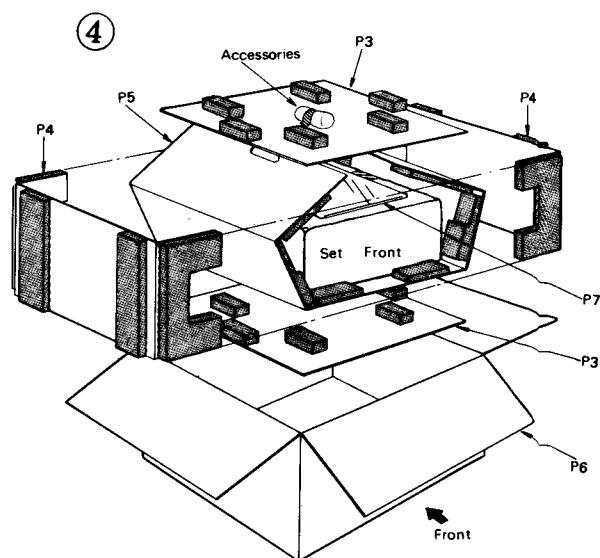
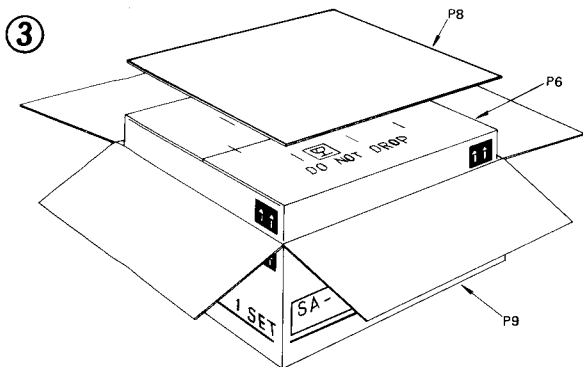
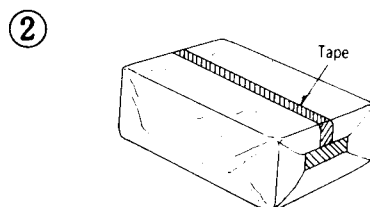
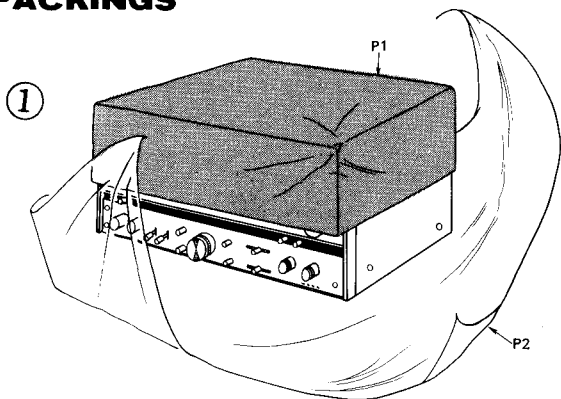

REPLACEMENT PARTS LIST

NOTES :

1. Part numbers are indicated on most mechanical parts. Please use this part number, for parts orders.
2. **(N)** indicates the New Parts.
3. **X-Z** rank: **X** rank parts will cover 80% of repair needs
X + Y rank parts will cover 95% of repair needs
Z rank parts are less necessary.

Bemerkungen :

1. Die meisten mechanischen Teile sind mit Teilnummern versehen. Bitte geben Sie diese Nummern an, sofern die Teile keine Bezugsnummern haben.
2. **(N)**, bedeutet: Neue Teile.
3. Gruppen **X-Z**: Teile der Gruppe **X** machen 80% des Ersatzteilbedarfes aus. Teile der Gruppen **X** und **Y** machen 95% des Ersatzteilbedarfes aus. Teile der Gruppe **Z** werden seltener benötigt.

Ref. No.	Part No.	Description	Per Set (Pcs.)	Remarks	Ref. No.	Part No.	Description	Per Set (Pcs.)	Remarks
INTEGRATED CIRCUIT					T201	RLI7W105S-T	AM 1st IF Transformer	1	X
					T202	RLI2C450	AM 2ndIF Transformer	1	X
IC301	SVIALA3300	MPX Circuit	1	X	T301, (T302)	SLMA1Z2-K	19kHz, 38kHz Pick-up Transformer	1	X
					T901	SLTA5Q10S	Power Transformer	1	(N) X
TRANSISTORS					CERAMIC FILTERS				
TR1	3SK39Q	FM RF Amplifier [FET]	1	X	CF1,101,102	RVFCF10M12CG	FM IF Circuit, Green (10.6 MHz)	each 3	X
TR2	2SC922M	FM Mixer	1	X		RVFCF10M12CB	FM IF Circuit, Black (10.65 MHz)		
TR3	2SC839H	FM Oscillator	1	X		RVFCF10M12CR	FM IF Circuit, Red (10.7 MHz)		
TR101,102, 103,104, 105,106, 107,108, 109,201, 202,203	2SC829C	FM IF Amp. Limiter & FM MIX, AM OSC & IF Amplifier	12	X		RVFCF10M12CW	FM IF Circuit, White (10.75 MHz)		
						RVFCF10M12CY	FM IF Circuit, Yellow (10.8 MHz)		
TR110,111, 713,714, 715,716	2SC828R	Muting Amp. Thermal Compensation	6	X	RESISTORS				
TR204,301, 302,605, 606,607, 608,609, 610	2SA666Q	FM/AM AF Amp, Tone Amp, & Phase Inverter	9	X	R4,103,137	ERD14TJ101	100Ω, ¼W, ±5%, Carbon	3	Y
TR303	2SA733MAP	Stereo Eye Switching	1	X	R129	ERD14TJ181	180Ω, ¼W, ±5%, Carbon	1	Y
TR401,402, 501,502, 503,504	2SA722T	Equalizer, Mic Amp. & 4ch Matrix	6	X	R111	ERD14TJ391	390Ω, ¼W, ±5%, Carbon	1	Y
TR403,404	2SC1328T	Equalizer & Mic Amp.	2	X	R116,311,312	ERD14TJ471	470Ω, ¼W, ±5%, Carbon	3	Y
TR601,602, 603,604	2SA721T	Volume Control Flat Amp.	4	(N) X	R302	ERD14TJ681	680Ω, ¼W, ±5%, Carbon	1	Y
TR701,702, 703,704, 705,706, 707,708	2SA666A-AD3	Differential Amplifier	8	X	R12,102,117, 316,605,606, 607,608	ERD14TJ102	1kΩ, ¼W, ±5%, Carbon	8	Y
TR709,710, 711,712, 717,718, 719,720	2SC1384A-Q	Pre Driver Amplifier	8	(N) X	R107,201	ERD14TJ152	1.5kΩ, ¼W, ±5%, Carbon	2	Y
TR721,722, 723,724	2SA684A-Q	Driver Amplifier	4	(N) X	R112	ERD14TJ222	2.2kΩ, ¼W, ±5%, Carbon	1	Y
TR725,726, 727,728, 729,730, 731,732	2SC789Y	Power Amplifier	8	X	R209	ERD14TJ272	2.7kΩ, ¼W, ±5%, Carbon	1	Y
TR801,802, TR803,804, 805	2SC828A-R 2SA684R	Speaker Protection Switching Amp. Switching & Ripple Filter	2 3	X X	R203	ERD14TJ322	3.3kΩ, ¼W, ±5%, Carbon	1	Y
DIODES and VARIATITE					R106	ERD14TJ392	3.9kΩ, ¼W, ±5%, Carbon	1	Y
D101,104,105 106,107,201, 202,205,206, 207,301	OA99	AGC, AOC, AM Detector & Meter Detector	11	X	R110,115,215 309,310	ERD14TJ472	4.7kΩ, ¼W, ±5%, Carbon	5	Y
D102,103	2-OA99	FM Discriminator	1 pair	X	R101,125,202, 534,535	ERD14TJ562	5.6kΩ, ¼W, ±5%, Carbon	5	Y
D108,109	1S1211	AOC, Meter Detector	2	X	R307,308	ERD14TJ103	10kΩ, ¼W, ±5%, Carbon	2	Y
D701	SVDEQA01-11R	Zener, 11V, Noise Cancel	1	X	R113	ERD14TJ153	15kΩ, ¼W, ±5%, Carbon	1	Y
D702,804	RVD10D1	Noise Cancel & Rectifier	2	X	.108,781,782, 783,784	ERD14TJ183	18kΩ, ¼W, ±5%, Carbon	5	Y
D801,806	SVDAC08P-1	Rectifier	2	X	R105,417	ERD14TJ273	27kΩ, ¼W, ±5%, Carbon	2	Y
D802	SVDAS2HB10	Rectifier	1	X	R121,423	ERD14TJ333	33kΩ, ¼W, ±5%, Carbon	2	Y
D803	SVDAEQB01-09	Zener, 9V, Voltage Stabilizer	1	X	R118	ERD14TJ393	33kΩ, ¼W, ±5%, Carbon	1	Y
V201	EYV320D1R2J3	Variatite, AOC	1	X	R313,314	ERD14TJ683	68kΩ, ¼W, ±5%, Carbon	2	Y
COILS and TRANSFORMERS					R305,306	ERD14TJ823	82kΩ, ¼W, ±5%, Carbon	2	Y
L1	SLAA4W1-1	Balun Coil	1	X	R3	ERD14TJ104	100kΩ, ¼W, ±5%, Carbon	1	Y
L2	SLAA4N9	FM Antenna Coil	1	X	R213	ERD14TJ124	120kΩ, ¼W, ±5%, Carbon	1	Y
L3	RLQY2555	Choke Coil	1	X	R1,2	ERD14TJ154	150kΩ, ¼W, ±5%, Carbon	2	Y
L4	SLDA4N18	FM DET Coil	1	X	R419	ERD14TJ394	390kΩ, ¼W, ±5%, Carbon	1	Y
L5	RLQY15G5	Choke Coil	1	X	R356	ERD14FJ3R3	3.3Ω, ¼W, ±5%, Carbon	1	Y
L6	SLOA4N9	FM OSC Coil	1	X	R318	ERD14FJ4R7	4.7Ω, ¼W, ±5%, Carbon	1	Y
L7,8,102,103, 104,203,801	SLOX151-1Y	Choke Coil	7	X	R357	ERD14FJ6R8	6.8Ω, ¼W, ±5%, Carbon	1	Y
L101	SLIA4B1	FM AGC Coil	1	X	R753,754,755, 756,761,762, 763,764	ERD14FJ100	10Ω, ¼W, ±5%, Carbon	8	Y
L201	SLFA2E15	AM Antenna Coil	1	X	R757,758,759, 760,761,766, 767,768	ERD14FJ221	220Ω, ¼W, ±5%, Carbon	8	Y
L202	SLOA2C6	AM OSC Coil	1	X	R733,734,735 736	ERD14FJ561	560Ω, ¼W, ±5%, Carbon	4	Y
T101	SLIA4C54	FM DISCRI IF Transformer (P)	1	X	R812	ERD18FJ4R7	4.7Ω, ¼W, ±5%, Carbon	1	(N) Y
T102	SLIA4C56	FM DISCRI IF Transformer (S)	1	X	R786	ERD12FJ101	100Ω, ¼W, ±5%, Carbon	1	(N) Y
T103,104	SLIA4C24	FM Muting IF Transformer (P), (S)	2	X	R777,778,779, 780	ERX1ANJ100	10Ω, 1W, ±5%, Metallic	4	(N) Y
					R351,352,353, 354	ERD12TJ221	220Ω, ¼W, ±5%, Carbon	4	Y
					R681	ERD12TJ681	680Ω, ¼W, ±5%, Carbon	1	Y
					R810	ERD14FJ120	12Ω, ¼W, ±5%, Carbon	1	Y
					R122	ERD14VJ820	82Ω, ¼W, ±5%, Carbon	1	Y
					R205,806	ERD14VJ101	100Ω, ¼W, ±5%, Carbon	2	Y
					R138	ERD14VJ221	220Ω, ¼W, ±5%, Carbon	1	Y
					R741,742,743, 744	ERD14VJ271	270Ω, ¼W, ±5%, Carbon	4	Y
					R7,120,415, 416	ERD14VJ391	390Ω, ¼W, ±5%, Carbon	4	Y
					R8,109,128, 208,214	ERD14VJ471	470Ω, ¼W, ±5%, Carbon	5	Y
					R749,750,751 752	ERD14VJ561	560Ω, ¼W, ±5%, Carbon	4	Y
					R429,501	ERD14VJ681	680Ω, ¼W, ±5%, Carbon	2	Y
					R315,625,626, 627,628,717, 718,719,720, 729,730,731, 732	ERD14VJ821	820Ω, ¼W, ±5%, Carbon	13	Y
					R11,123,124, 421,422,504, 505,705,706, 707,708,745, 746,747,748, 785	ERD14VJ102	1kΩ, ¼W, ±5%, Carbon	16	Y

Ref. No.	Part No.	Description	Per Set (Pcs.)	Remarks	Ref. No.	Part No.	Description	Per Set (Pcs.)	Remarks
R218,407,408,641,642,643,644	ERD14VJ122	1.2kΩ, ¼W, ±5%, Carbon	7	Y	VR601-1~601-4	EVV83A030BF5	250kΩ (B), Main Volume Control	1	X
R804	ERD14VJ152	1.5kΩ, ¼W, ±5%, Carbon	1	Y	VR602-1~602-4	EVV84A030B15	100kΩ (B), Bass & Treble Control	2	(N) X
R669,670,671,672	ERD14VJ222	2.2kΩ, ¼W, ±5%, Carbon	4	Y	VR603-1~603-4	EVLS3AA00B52	500Ω (B), ICC Adjustment	4	X
R131,661,662,663,664,721,722,723,724	ERD14VJ272	2.7kΩ, ¼W, ±5%, Carbon	9	Y	VR705,706,707,708				
R119,303,304,809	ERD14VJ332	3.3kΩ, ¼W, ±5%, Carbon	4	Y					
R114,135,527,621,622,623,624,737,738,739,740	ERD14VJ392	3.9kΩ, ¼W, ±5%, Carbon	11	Y					
THERMISTORS									
R126,130,206,301,525,688,689	ERD14VJ472	4.7kΩ, ¼W, ±5%, Carbon	7	Y	TH701,702,703,704	RRT251	Driver Circuit	4	Y
CAPACITORS									
R207,677,678,679,680,686,687	ERD14VJ562	5.6kΩ, ¼W, ±5%, Carbon	7	Y	C131	ECCD1H0R5CC	0.5pF, 50WV, ±0.25pF, Ceramic	1	Z
R423,424,665,666,667,668	ERD14VJ682	6.8kΩ, ¼W, ±5%, Carbon	6	Y	C9	ECCD1H010CC	1pF, 50WV, ±0.25pF, Ceramic	1	Z
R217,510,511	ERD14VJ822	8.2kΩ, ¼W, ±5%, Carbon	3	Y	C217	ECCD1H050CC	5pF, 50WV, ±0.25pF, Ceramic	1	Z
R104,134,204,211,212,317,512,513,526,528,529,633,634,635,636,645,646,647,648,713,714,715,716,845	ERD14VJ103	10kΩ, ¼W, ±5%, Carbon	24	Y	C111	ECCD1H100KC	10pF, 50WV, ±10%, Ceramic	1	Z
R10,127,530,637,638,639,640,811	ERD14VJ153	15kΩ, ¼W, ±5%, Carbon	8	Y	C11	ECCD1H100KU	10pF, 50WV, ±10%, Ceramic	1	Z
R6,514,515,601,602,603,604	ERD14VJ183	18kΩ, ¼W, ±5%, Carbon	7	Y	C19	ECCD1H100KT	10pF, 50WV, ±10%, Ceramic	1	Z
R9	ERD14VJ223	22kΩ, ¼W, ±5%, Carbon	1	Y	C1	ECCD1H120KC	12pF, 50WV, ±10%, Ceramic	1	Z
R613,614,615,616	ERD14VSJ223	22kΩ, ¼W, ±5%, Carbon	4	(N) Y	C6,12,14	ECCD1H150KC	15pF, 50WV, ±10%, Ceramic	3	Z
R617,618,619,620	ERD14VSJ273	27kΩ, ¼W, ±5%, Carbon	4	(N) Y	C5	ECCD1H180KC	18pF, 50WV, ±10%, Ceramic	1	Z
R418,803	ERD14VJ273	27kΩ, ¼W, ±5%, Carbon	2	Y	C130	ECCD1H330KC	33pF, 50WV, ±10%, Ceramic	1	Z
R411,412,802	ERD14VJ333	33kΩ, ¼W, ±5%, Carbon	3	Y	C13	ECCD1H390KC	39pF, 50WV, ±10%, Ceramic	1	Z
R132,133,409,410,801	ERD14VJ473	47kΩ, ¼W, ±5%, Carbon	5	Y	C119	ECCD1H470KU	47pF, 50WV, ±10%, Ceramic	1	Z
R520,536,709,710,711,712,725,726,727,728	ERD14VJ563	56kΩ, ¼W, ±5%, Carbon	10	Y	C717,718,719,720	ECCD1H560K	56pF, 50WV, ±10%, Ceramic	4	Z
R5	ERD14VJ823	82kΩ, ¼W, ±5%, Carbon	1	Y	C121,122,132	ECCD1H101K	100pF, 50WV, ±10%, Ceramic	3	Z
R216,401,402,427,673,674,675,676,690,691,701,702,703,704	ERD14VJ104	100kΩ, ¼W, ±5%, Carbon	14	Y	C420	ECCD1H121K	120pF, 50WV, ±10%, Ceramic	1	Z
R508,509,609,610,611,612	ERD14VSJ104	100kΩ, ¼W, ±5%, Carbon	6	(N) Y	C405,406	ECCD1H151K	150pF, 50WV, ±10%, Ceramic	2	Z
R425,426	ERD14VJ124	120kΩ, ¼W, ±5%, Carbon	2	Y	C7	ECCD1H181K	180pF, 50WV, ±10%, Ceramic	1	Z
R405,406,657,658,659,660	ERD14VSJ124	120kΩ, ¼W, ±5%, Carbon	6	(N) Y	C208	ECCD1H221K	220pF, 50WV, ±10%, Ceramic	1	Z
R516,517,518,519,531,532,537	ERD14VJ154	150kΩ, ¼W, ±5%, Carbon	7	Y	C134,421,705,706,707,708	ECCD1H331K	330pF, 50WV, ±10%, Ceramic	6	Z
R506,507,523,524	ERD14VSJ184	180kΩ, ¼W, ±5%, Carbon	4	(N) Y	C356	ECKD1H471KB	470pF, 50WV, ±10%, Ceramic	1	Z
R684,685	ERD14VSJ224	220kΩ, ¼W, ±5%, Carbon	2	(N) Y	C407,408,609,610,611,612	ECKD1H821KB	820pF, 50WV, ±10%, Ceramic	6	Z
R210	ERD14VJ224	220kΩ, ¼W, ±5%, Carbon	1	Y	C2,3,4,8,15,20	ECKD1H102PF	0.001μF, 50WV, +100%, -0%, Ceramic	6	Z
R502,503	ERD14VJ274	270kΩ, ¼W, ±5%, Carbon	2	Y	C732,733,734,735	ECKE1H102MD	0.001μF, 50WV, ±20%, Ceramic	4	Z
R413,414	ERD14VSJ274	270kΩ, ¼W, ±5%, Carbon	2	Y	C10,17,18,102,106,108,112,115,809,810,813,814	ECKE1H103PF	0.01μF, 50WV, +100%, -0%, Ceramic	12	Z
R521,522,653,654,655,656	ERD14VSJ394	390kΩ, ¼W, ±5%, Carbon	6	(N) Y	C104,107,110,114,120,126,129,133,136,201,204,209	ECKE1H223PF	0.022μF, 50WV, +100%, -0%, Ceramic	12	Z
R420	ERD14VJ394	390kΩ, ¼W, ±5%, Carbon	1	Y	C823,824	ECKD1H473ZF	0.047μF, 50WV, +80%, -20%, Ceramic	2	Z
R136,533	ERD14VJ474	470kΩ, ¼W, ±5%, Carbon	2	Y	C817	CEKD2H103PF	0.01μF, 500WV, +100%, -0%, Ceramic	1	Z
R682,683	ERD14VSJ474	470kΩ, ¼W, ±5%, Carbon	2	(N) Y	C302	ECQG05152KZN	0.0015μF, 50WV, ±10%, Polyester	1	Z
R403,404	ERD14VSJ824	820kΩ, ¼W, ±5%, Carbon	2	Y	C629,630,631,632	ECQG05222KZN	0.0022μF, 50WV, ±10%, Polyester	4	Z
R629,630,631,632,649,650,651,652	ERD14VJ824	820kΩ, ¼W, ±5%, Carbon	8	(N) Y	C411,412	ECQG05272JZU	0.0027μF, 50WV, ±5%, Polyester	2	Z
R769,770,771,772,773,774,775,776	ERX2ANKR33	0.33Ω, 2W, ±10%, Metallic	8	Y	C413,414	ECQG05822JZN	0.0082μF, 50WV, ±5%, Polyester	2	Z
R807	ERM2P201	200Ω, 2W, ±5%, Wire	1	Z	C215	ECQG05332KZN	0.0033μF, 50WV, ±10%, Polyester	1	Z
R808	ERM4P271	270Ω, 4W, ±5%, Wire	1	Z	C203,211,212,515	ECQG05103KZN	0.01μF, 50WV, ±10%, Polyester	4	Z
VARIABLE RESISTORS									
VR1	EVV17AA1654U	50kΩ (ZU), AFD Control (WIDTH)	1	(N) X	C101,103,105,109,113,117,118,124,127,139,202,621,622,623,624,625,626,627,628	ECQG05223KZN	0.022μF, 50WV, ±10%, Polyester	19	Z
VR2-1,2-2	EVA77AA16D55	500kΩ (D), AFD Control (DEPTH)	1	(N) X	C205,601,602,603,604	ECQG05333KZN	0.033μF, 50WV, ±10%, Polyester	5	Z
VR3,4,5,6	EVH56A034BF5	250kΩ (B), Channel Level Control	4	(N) X	C513,514	ECQG05473KZN	0.047μF, 50WV, ±10%, Polyester	2	Z
VR101	EVLS3AA00B24	20kΩ (B), Meter Adjustment	1	X	C725,726,727,728	ECOM05473KZ	0.047μF, 50WV, ±10%, Polyester	4	Z
VR102	EVLS3AA00B54	50kΩ (B), Muting Level Adjustment	1	X	C207	ECQG05563KZN	0.056μF, 50WV, ±10%, Polyester	1	Z
VR301,701,702,703,704	EVLS3AA00B13	1kΩ (B), Separation & DC Unbalance Adj.	5	X	C308,309	ECQG0562JZN	0.0056μF, 50WV, ±5%, Polyester	2	Z
					C352,353	ECQU2A103MD	0.01μF, 250VAC, ±20%, Polyester	2	Z
					C417,418	ECSZ35EF4R7	0.47μF, 35WV, Electrolytic	2	Y
					C403,404,506,507	ECSZ25EF3R3	3.3μF, 25WV, Electrolytic	4	Y
					C419,617,618,619,620,641,642,643,644	ECSZ25EF4R7	4.7μF, 25WV, Electrolytic	9	Y
					C116,213,214	ECAG25ER1X	0.1μF, 25WV, Electrolytic	3	Y
					C504,505,508,509,510,511,512,605,606,607,608,633,634,635,636	ECAG25ER47X	0.47μF, 25WV, Electrolytic	5	Y
					C502,503,645,646,647,648	ECAG25ER68X	0.68μF, 25WV, Electrolytic	6	Y
					C409,410,637,638,639,640,709,710,711,712	ECEA6V47	47μF, 6.3WV, Electrolytic	10	Y
					C351	ECEA6V100	100μF, 6.3WV, Electrolytic	1	Y

Ref. No.	Part No.	Description	Per Set (Pcs.)	Remarks	Ref. No.	Part No.	Description	Per Set (Pcs.)	Remarks				
C415,416,613,614,615,616	ECEA10V33	33µF, 10WV, Electrolytic	6	Y	CA15	SJAA3	Cord, AC Power Source	1	Z				
C125	ECEA10V100	100µF, 10WV, Electrolytic	1	Y	CA16	RHR111	Bushing, AC Cord	1	Z				
C801	ECEA10V220	220µF, 10WV, Electrolytic	1	Y	CA17	SJFA5202	Cap. Circuit Protection Fuse Holder	2	Z				
C822	ECEA10V470	470µF, 10WV, Electrolytic	1	Y	CA18	XSN26+12	Screw, Fuse Holder M'tg.	2	Z				
C821	ECEA10V1000	1000µF, 10WV, Electrolytic	1	Y	CA19	SUPA1980	Printed Circuit Board Only	1	Z				
C137,138,206301	ECEA16V10	10µF, 16WV, Electrolytic	4	Y	CA19	XTV3D8CR	Red Screw, Bottom Board M'tg.	8	Z				
C808	ECEA16V47	47µF, 16WV, Electrolytic	1	Y	CA20	SYUA61A	Bottom Board, Complete	1	Z				
C135,216,303	ECEA25V3R3	3.3µF, 25WV, Electrolytic	3	Y	CA21	SKLA2-1	Leg	4	Z				
C123	ECEA25V4R7	4.7µF, 25WV, Electrolytic	1	Y	CA21	SKUA321	Bottom Board Only (Order SYUA61A)	(1)	Z				
C310,401,402,803	ECEA25V33	33µF, 25WV, Electrolytic	4	Y	CA22	SHEA3-1	Lock Pin, Leg	4	Z				
C713,714,715,716,721,722,723,724	ECEA25V47	47µF, 25WV, Electrolytic	8	Y	CA23	XTV3D8CK	Black Screw, Complete Panel M'tg.	6	Z				
C730	ECEA25V100	100µF, 25WV, Electrolytic	1	Y	CA24	SYWA101A	Front Panel, Complete	1	Z				
C729	ECEA25V220	220µF, 25WV, Electrolytic	1	Y	CA25	SGXA52	Side Panel, Right	1	Z				
C649	ECEA25V470	470µF, 25WV, Electrolytic	1	Y	CA25	SGXA53	Side Panel, Left	1	Z				
C304,305,306307,701,702,703,704	ECEA50V1	1µF, 50WV, Electrolytic	8	Y	CA26	SGWA1110	Panel, Printed Indicator (Order SYWA101A)	(1)	Z				
C357,358,422,501,811,815	ECEA50V100	100µF, 50WV, Electrolytic	6	Y	CA27	SGUA12	Panel, Dial	1	Z				
C812	ECEA50V330	330µF, 50WV, Electrolytic	1	Y	CA28	XTV3D8C	Screw, Panel M'tg.	11	Z				
C816	ECEA50V470	470µF, 50WV, Electrolytic	1	Y	CA29	SGBA46	Badge, National Technics	1	Z				
C804,805	ECET35R4700Y	4700µF, 35WV, Electrolytic	2	Y	CA30	SULA37	Mounting, Panel (Right Side)	1	Z				
					CA30	SULA36	Mounting, Panel (Left Side)	1	Z				
					CA31	SBNA100	Knob, Tuning Control	1	X				
					CA32	SBNA103	Knob, Bass, Treble, Selector & Mode	4	X				
					CA33	SBDA1	Knob, AFD Control	2	X				
					CA34	SBNA101	Knob, Channel Level Control	4	X				
					CA35	SBNA102	Knob, Main Volume Control	1	X				
					CA36	SBLA2	Knob, Muting & Loudness Switch	2	X				
					CA37	SBCA47	Button, Power Source Switch	1	X				
VARIABLE CAPACITORS					CHASSIS								
CV1,2,3,4,5, (CT4,5)	ECV5MX25X14C	Tuning Gang, FM/AM (Trimmer, AM ANT & AM OSC)	1	X	CH1	SJTA307	Pin Terminal, Circuit Connection	153	Z				
CT1,2	ECV1Z1W10P32	Trimmer, FM ANT & FM DET, 10pF	2	X	CH2	SJSA63	Socket, Connector, 4 pin (Refer to page 13)	9	Z				
CT3	ECV1Z1W06P35	Trimmer, FM OSC, 6pF	1	X	CH2	SJSA64	Socket, Connector, 6 pin (Refer to page 13)	2	Z				
COMPONENT COMBINATIONS					CH3	SJT701	Cramp, Lead Wire	43	Z				
M101	EXA5DL04C	FM Discriminator Circuit	1	X	CH3	SMYA36	Heat Sink, Power Transistor	1	Z				
M301,302	SXAM675F	Low Pass Filter, 19kHz & 38kHz	2	Y	CH4	SMYA37	Heat Sink, Rectifier (D802)	1	Z				
M801,802,803,804	RXAF103P22HD	Hum Cancel, 0.01µF (X2)	4	Y	CH4	SJSA65	Socket, Circuit Connection	18	Z				
SWITCHES					CH5	XTV3D8CK	Black Screw, FM/AM Tuner M'tg.	9	Z				
S1-1~S1-10	SSRA49	Selector Switch	1	X	CH5	SDTA3S	Shaft, Tuning Control, Complete	1	Z				
S2-1~S2-6	SSRA48	Mode Switch	1	X	CH6	SDXA705S	Flywheel } Order SDTA3S	(1)	Z				
S3-1~S3-4	SSHA35S	Tape Monitor 1 & 2 Switch	1	X	CH7	SDTA6003	Shaft only }	(1)	Z				
S4-1~S4-4					Balanced Transformerless Switch (Refer to Ref. No. CA11)	1	X	CH8	SJJA12	Jack, Microphone	1	Z	
S5-1~S5-2	S6	SSLA18S	1	X				CH9	SJSA201	Holder, Dial Light	1	Z	
S7-1~S7-4					SSLA19S	Loudness Switch	1	X	CH10	RHG5-1	Rubber Cushion, Variable Capacitor	1	Z
S8-1,S8-2	ESB702S	Power Source Switch	1	X					CH11	SDDA391S	Drum, Dial Cord	1	Z
S9-1~S9-4					SSRA7S	Voltage Selector Switch	1	X	CH11	XXAR3H6S	Screw, Drum M'tg.	2	Z
SPEAKER PROTECTION RELAY									CH12	RDZ05-5	Cord, Dial, 63 1/2" (160 cm)	1 roll	Z
	SSYA1	Relay, Speaker Protection	1	X	CH12	SDSA4141	Spring, Dial Cord	1	Z				
FUSES					CH13	SDDA8	Slider, Dial Pointer	1	Y				
F1,2,3,4	XBAS1A3001	3A, Circuit Protection	4	X	CH13	SDPA3	Pointer, Dial	1	Y				
F801,802					XBAS1B3001	3A, Power Source	2	X	CH14	RDR23	Pulley, Dial Cord	2	Z
F803									XBAS1B1501	1.5A, Power Source	1	X	CH15
LAMPS					CH16	SUMA5	Mounting, Dial Scale	1					Z
PL1,2,3,11	XAM37K250	Stereo Eye, Ch. indicator (7.5V 75mA)	4	X	CH17	RJV1A	Holder, Meter Light	1	Z				
PL4,5,6,7,8,9	XAM35K	Dial & Meter Lamp (6.3V 0.25A)	6	X	CH18	SHGA634	Rubber Cushion, Dial Scale	1	Z				
PL10	XAMR33S400	Pointer Lamp (6.3V 75mA)	1	X	CH19	SHGA202	Bracket, Stereo Eye	1	Z				
CABINETS					CH20	SSMA19-2	Meter, Signal	1	X				
CA1	XSB4+16BVCS	Screw, Cabinet M'tg.	4	Z	CH21	SJJA9-1	Jack, Headphones	2	Z				
CA2	SKAA610	Cabinet, Complete	1	Y	CH22	SKDA350	Scale, Dial	1	Y				
CA3	SKMA170	Wooden Cabinet	(1)	Z	CH23	SGEA3	Cap, Channel Indicator Cover	1	Z				
	SKPA3	Hole, Ventilation	(1)	Z	CH24	SGKA131	Indicator, Channel	1	Z				
	SYPA181AS	Rear Panel, Complete	1	Z	CH25	SDUA4	Panel, Channel Indicator	1	Z				
CA4	SNEA404	Nut, Ground Terminal [Outer]	1	Z	CH26	SHRA605	Cover, Channel Indicator Light	1	Z				
CA5	SNEA204-2S	Volt, Ground Terminal	1	Z	CH27	SDUA3	Bracket, Channel Indicator Light, Red	1	Z				
	SJFA3010	Terminal, Tape Monitor 1,2, PHONO, AUX 1,2, & 4CH MPX OUT	1	Z	CH28	SDUA5	Bracket, Channel Indicator Light, Green	2	Z				
CA6	SGPA320B	Rear Panel Only	1	Z	CH29	SHRA604	Holder, Channel Indicator Light	1	Z				
CA7	SJFA5201	Holder, Circuit Protection Fuses	2	Z	ACCESSORIES								
CA8	SGTA1520	Name Plate	1	Z	A1	SSAA1	Cord, FM Antenna	1	Y				
CA9	SJFA4401	Terminal, Ext., Antenna	1	Z	A2	XBAS1A3001	Fuse, Circuit Protection [3A]	4	X				
CA10	RJS7A	Socket, 4 channel Controller	1	Z	A3	RJP5	Pin Plug	8	Y				
CA11	SSSA3S	Switch, Balanced Transformerless (S5)	1	Z	A4	RJP16AS	Plug, AC Power Source	1	Y				
CA12	SJFA4806	Terminal, Speakers	1	Z	A5	RJP17AS	Plug, AC Power Source	1	Y				
CA13	SJSA1	Socket, AC Outlet	2	Z	PACKING PARTS								
CA14	SMKA3S	Mounting, AC Outlet	1	Z	P1	SPPA19	Soft Cover	1	Z				
					P2	SPEA3	Cover, AC Plug	1	Z				
					P3	SPHA6008	Polyethylene Sheet	1	Z				
					P4	SPSA58	Pad, Upper & Lower	2	Z				
					P5	SPSA57	Pad, Right & Left Side	2	Z				
					P6	SPSA56	Pad, Inside	1	Z				
					P7	SPNA170A	Carton Box (Inner)	1	Z				
					P8	SQFA158	Printed Matter, Complete	1	Z				
					P9	SQXA5100	Instructions Book (Order SQFA158)	(1)	Z				
						SPNA142	Pad, Carton Box	1	Z				
						SPGA251A	Carton Box (Outer)	1	Z				
FOR HOLLAND ONLY Change of Parts List													
					A4	RJP16AS	Accessory, AC Plug (Deletion)	1					
					A5	RJP17AS	Accessory, AC Plug (Deletion)	1					
						SPEA3	AC Plug Cover (Deletion)	1					
						RJP3A	AC Plug, Power Source Cord (Addition)	1					
						SPEA4	AC Plug Cover (Addition)	1					