

Service Manual

AV Control Stereo Receiver



Receiver

SA-AX7

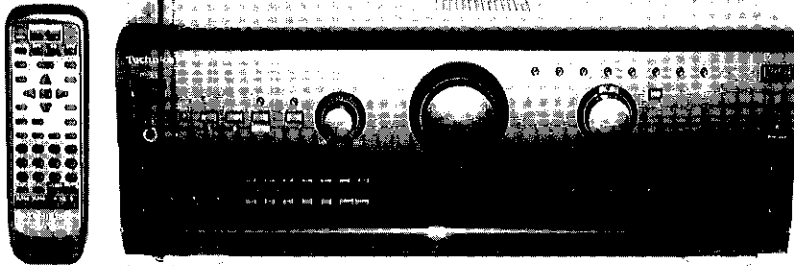

Colour

(K) Black Type

Area

Suffix for Model No.	Area	Colour
(E)	Europe	(K)
(EB)	Great Britain	
(EG)	Germany and Italy	

Manufactured under license from Dolby Laboratories Licensing Corporation. DOLBY, the double-D symbol and "PRO LOGIC" are trademarks of Dolby Laboratories Licensing Corporation.

Specifications

Amplifier Section

Power output (at 240 V)
 DIN 1 kHz (T.H.D. 1%) 2 x 100 W (6Ω)
 20 Hz-20 kHz continuous power output both channel driven 2 x 80 W (6Ω)

Total harmonic distortion
 Rated power at 20 Hz – 20 kHz 0.05 % (6Ω)
 Half power at 1 kHz 0.03 % (6Ω)

Power output at the Dolby Pro Logic operation
 DIN 1 kHz (T.H.D. 1%)
 Front 2 X 100 W (6Ω)
 Center 100 W (6Ω)
 Surround 2 X 100 W (6Ω)
 Subwoofer (f=100 Hz) 100 W (6Ω)

Power bandwidth
 both channel driven, -3 dB 10 Hz - 40 kHz (6Ω)

Damping factor 30 (6Ω)

Load impedance
 Front A or B 4 - 16 Ω
 A and B 8 - 16 Ω
 BI-WIRE 6 - 16 Ω
 Center 6 - 16 Ω
 Surround 6 - 16 Ω
 Subwoofer 6 - 16 Ω

Frequency response
 PHONO RIAA standard curve (30 Hz-15 kHz) ± 0.8 dB
 CD, TAPE, DVD, VCR 1, TV/VCR 2, VCR 3 10 Hz – 40 kHz, ± 3 dB

Input sensitivity and impedance
 PHONO 3 mV / 47 kΩ
 CD, TAPE, DVD, VCR 1, TV/VCR 2, VCR 3 200 mV / 22 kΩ

S/N at rated power (6 Ω) (VGCA ON)
 PHONO 70 dB (IHF, A: 80 dB)
 CD, TAPE, DVD (L/R/C/LS/RS), VCR 1, TV/VCR 2, VCR 3 98 dB (IHF, A: 100 dB)
 110 dB (IHF A, rated power, S=2 V)

Tone controls
 BASS 50 Hz, +10 to -10 dB
 TREBLE 20 kHz, +10 to -10 dB

Output voltage
 TAPE REC (OUT), VCR 1 OUT 200 mV
 Channel balance (250 Hz-6.3 kHz) ± 1 dB
 Channel separation 55 dB
 Adaptive control (volume at -30 dB) 50 Hz, +5 dB
 Headphones output level and impedance 430 mV / 330Ω
 Subwoofer cut off frequency control 50 – 200 Hz

FM Tuner Section

Frequency range 87.50 — 108.00 MHz

Sensitivity
 S/N 30 dB 1.5 μV/75 Ω
 S/N 26 dB 1.3 μV/75 Ω
 S/N 20 dB 1.2 μV/75 Ω

46 dB quieting sensitivity 22 μV/75 Ω

Total harmonic distortion
 MONO 0.2 %
 STEREO 0.3 %

S/N
 MONO 60 dB (75 dB, IHF)
 STEREO 58 dB (71 dB, IHF)

Frequency response 20 Hz — 15 kHz (+1 dB, -2 dB)

Alternate channel selectivity 65 dB
Capture ratio 1.5 dB
Image rejection at 98 MHz 40 dB
IF rejection at 98 MHz 70 dB
Spurious response rejection at 98 MHz 70 dB
AM suppression 50 dB
Stereo separation
 1 kHz 40 dB
Antenna terminal 75 Ω (unbalanced)

WARNING

This service information is designed for experienced repair technicians only and is not designed for use by the general public. It does not contain warnings or cautions to advise non-technical individuals of potential dangers in attempting to service a product. Products powered by electricity should be serviced or repaired only by experienced professional technicians. Any attempt to service or repair the product or products dealt with in this service information by anyone else could result in serious injury or death.

■ AM Tuner Section

Frequency range	522 — 1611 kHz
	530 — 1620 kHz
Sensitivity	20 μ V, 330 μ V/m
Selectivity	55 dB
IF rejection at 1000 kHz	50 dB

■ Video Section

Output voltage at 1 V input (unbalanced)	1 \pm 0.1 Vp-p
Maximum input voltage	1.5 Vp-p
Input/output impedance	75 Ω

■ General

Power consumption	300 W
Power supply (E/EG)	AC 230 V, 50 Hz
(EB)	AC 230 – 240 V, 50 Hz
Dimensions (W x H x D)	430 x 158 x 378.4 mm
Weight	11 kg

Notes :

- Specifications are subject to change without notice. Weight and dimensions are approximate.
- Total harmonic distortion is measured by the digital spectrum analyzer.

■ Contents

	PAGE	PAGE	
• BEFORE REPAIR AND ADJUSTMENT	2	• OPERATION CHECKS	15 ~ 18
• PROTECTION CIRCUITRY	2	• TERMINAL FUNCTION OF ICs	19
• CAUTION FOR AC MAINS LEAD	3	• TYPE ILLUSTRATION OF ICs, TRANSISTORS & DIODES	20
• ACCESSORIES	4	• SCHEMATIC DIAGRAM	21 ~ 35
• FRONT PANEL CONTROLS	4 ~ 5	• PRINTED CIRCUIT BOARD	36 ~ 45
• EQUIPMENT CONNECTIONS	5 ~ 7	• WIRING DIAGRAM	46
• SPEAKER CONNECTIONS	7 ~ 8	• BLOCK DIAGRAM	47 ~ 52
• BASIC OPERATIONS	9 ~ 10	• CABINET PARTS LOCATION	53
• DOLBY PRO LOGIC	10 ~ 12	• REPLACEMENT PARTS LIST	54 ~ 57
• DVD 6CH INPUT MODE	12	• RESISTORS & CAPACITORS	58 ~ 63
• VGCA MODE	13	• PACKAGING MATERIALS & ACCESSORIES	64
• OTHER FUNCTIONS	13	• PACKAGING	64
• MAKING A RECORDING	14		

■ Before Repair and Adjustment

Disconnect AC power, discharge 2 Power Supply Capacitors C703, C704, C705 and C706 through a 10 Ω , 5W resistor to ground. DO NOT SHORT-CIRCUIT DIRECTLY (with a screwdriver blade, for instance), as this may destroy solid state devices.

After repairs are completed, restore power gradually using a variac, to avoid overcurrent.

For E, EG: Current consumption at AC 230 V, 50Hz in NO SIGNAL mode should be 120 ~ 380 mA.

For EB: Current consumption at AC 230/240 V, 50Hz in NO SIGNAL mode should be 130 ~ 410 mA.

■ Protection Circuitry

The protection circuitry may have operated if either of the following conditions are noticed :

- No sound is heard when the power is turned on.
- Sound stops during a performance.

The function of this circuitry is to prevent circuitry damage if, for example, the positive and negative speaker connection wires are "shorted", or if speaker systems with an impedance less than the indicated rated impedance of the amplifier are used.

If this occurs, follow the procedure outlines below:

1. Turn off the power.
2. Determine the cause of the problem and correct it.
3. Turn on the power once again after one minute.

Note:

When the protection circuitry functions, the unit will not operate unless the power is first turned off and then on again.

Caution for AC Mains Lead

("EB" area code model only)

For your safety, please read the following text carefully.

This appliance is supplied with a moulded three pin mains plug for your safety and convenience.

A 5-ampere fuse is fitted in this plug.

Should the fuse need to be replaced please ensure that the replacement fuse has a rating of 5-ampere and that it is approved by ASTA or BSI to BS1362.

Check for the ASTA mark  or the BSI mark  on the body of the fuse.

If the plug contains a removable fuse cover you must ensure that it is refitted when the fuse is replaced.

If you lose the fuse cover the plug must not be used until a replacement cover is obtained.

A replacement fuse cover can be purchased from your local dealer.

CAUTION!

IF THE FITTED MOULDED PLUG IS UNSUITABLE FOR THE SOCKET OUTLET IN YOUR HOME THEN THE FUSE SHOULD BE REMOVED AND THE PLUG CUT OFF AND DISPOSED OF SAFELY.

THERE IS A DANGER OF SEVERE ELECTRICAL SHOCK IF THE CUT OFF PLUG IS INSERTED INTO ANY 13-AMPERE SOCKET.

If a new plug is to be fitted please observe the wiring code as stated below.

If in any doubt please consult a qualified electrician.

IMPORTANT

The wires in this mains lead are coloured in accordance with the following code:

Blue: Neutral

Brown: Live

As these colours may not correspond with the coloured markings identifying the terminals in your plug, proceed as follows:

The wire which is coloured Blue must be connected to the terminal which is marked with the letter N or coloured Black or Blue.

The wire which is coloured Brown must be connected to the terminal which is marked with the letter L or coloured Brown or Red.

WARNING: DO NOT CONNECT EITHER WIRE TO THE EARTH TERMINAL WHICH IS MARKED WITH THE LETTER E, BY THE EARTH SYMBOL \perp OR COLOURED GREEN OR GREEN/YELLOW.

THIS PLUG IS NOT WATERPROOF—KEEP DRY.

Before use

Remove the connector cover.

How to replace the fuse

The location of the fuse differ according to the type of AC mains plug (figures A and B). Confirm the AC mains plug fitted and follow the instructions below. Illustrations may differ from actual AC mains plug.

1. Open the fuse cover with a screwdriver.

Figure A

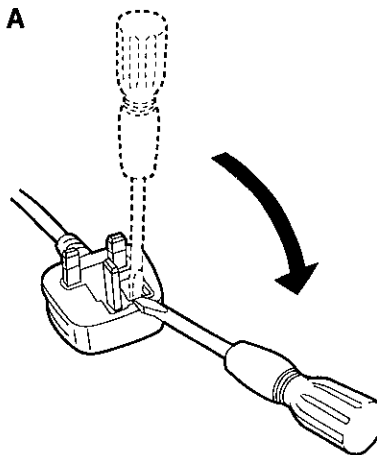
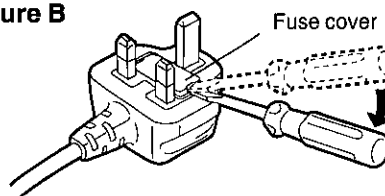

Figure B



2. Replace the fuse and close or attach the fuse cover.

Figure A

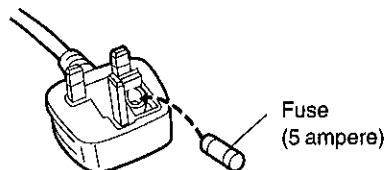
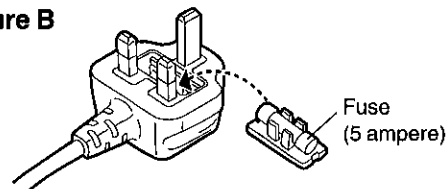
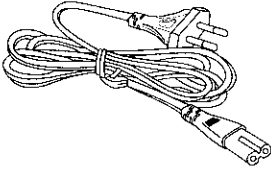
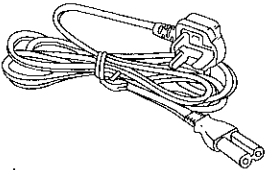

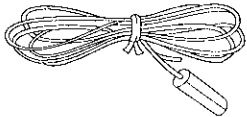
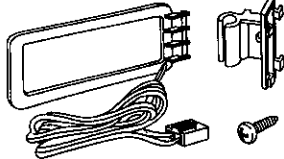

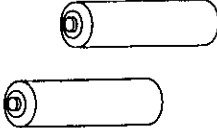

Figure B



Accessories

 <p>For other AC power supply cord 1pc.</p>	 <p>For United Kingdom AC power supply cord 1pc.</p>	 <p>Remote control1pc.</p>	 <p>FM indoor antenna1pc.</p>
 <p>AM loop antenna set1pc.</p>	 <p>FM indoor antenna1pc.</p>	 <p>Batteries 2pc.</p>	

Front Panel Controls

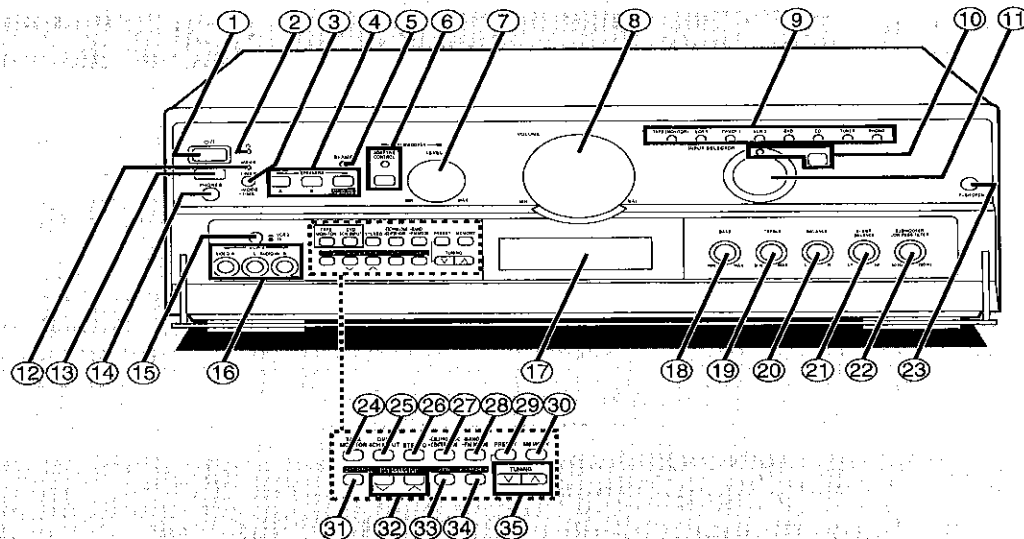

Main unit

No.	Name	No.	Name
①	Standby/on switch (⏻/⏻) Press to switch the unit from on to standby mode or vice versa. In standby mode, the unit is still consuming a small amount of power.	①7	Display section
②	Standby Indicator (⏻) When the unit is connected to the AC mains supply, this indicator lights up in standby mode and goes out when the unit is turned on.	①8	Bass control (BASS)
③	Timer button (TIMER, -MODE, -TIME)	①9	Treble control (TREBLE)
④	Speaker select buttons (SPEAKERS A, B, BI-WIRE)	②0	Balance control (BALANCE)
⑤	BI-amp indicator (BI-AMP)	②1	Bi-amp balance control (BI-AMP BALANCE)
⑥	Adaptive subwoofer control/indicator (SUBWOOFER ADAPTIVE CONTROL)	②2	Subwoofer low pass filter control (SUBWOOFER LOW PASS FILTER)
⑦	Subwoofer level control (SUBWOOFER LEVEL)	②3	Front cover open button (PUSH OPEN)
⑧	Volume control (VOLUME)	②4	Tape monitor button (TAPE MONITOR)
⑨	Input indicator	②5	DVD 6CH INPUT select button (DVD 6CH INPUT)
⑩	VGCA mode select button/indicator (VGCA)	②6	Dolby Pro Logic mode off button (STEREO)
⑪	Input selector (INPUT SELECTOR)	②7	Dolby Pro Logic mode/center mode select button (-□□PRO LOGIC, -CENTER MODE)
⑫	Wake indicator (WAKE)	②8	Band select/FM mode select button (-BAND, -FM MODE)
⑬	Remote control signal sensor	②9	Preset channel button (PRESET)
⑭	Headphone jack (PHONES)	③0	Memory button (MEMORY)
⑮	TV/VCR 2 input select button (TV, VCR 2)	③1	RDS display mode select button (DISPLAY MODE)
⑯	VCR 2 terminals (VCR 2)	③2	PTY selector (PTY SELECTOR ∇, ^)
		③3	EON button (EON)
		③4	PTY search button (PTY SEARCH)
		③5	Tuning buttons (TUNING ∇, ^)

Front panel controls

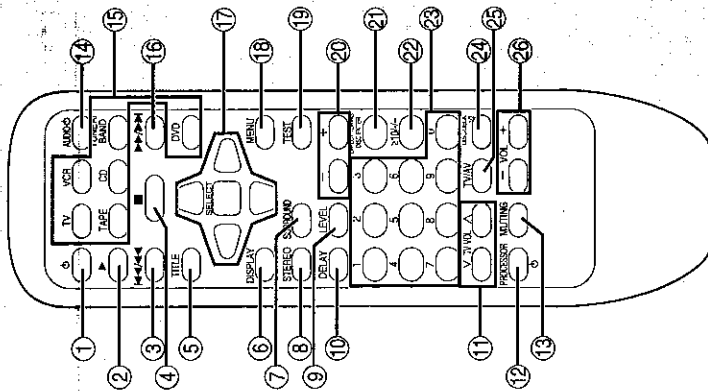

- | Remote control | No. | Name |
|----------------|-----|--|
| | 1 | Standby/on button (⏻) |
| | 2 | ▶ button (▶) |
| | 3 | ◀◀/▶▶ button (◀◀/▶▶) |
| | 4 | ■ button (■) |
| | 5 | Title button (TITLE) |
| | 6 | Display button (DISPLAY) |
| | 7 | Dolby Pro Logic surround select button (SURROUND) |
| | 8 | Dolby Pro Logic off button (STEREO) |
| | 9 | Speaker channel select button (LEVEL) |
| | 10 | Delay time button (DELAY) |
| | 11 | TV volume buttons (V TV VOL ▲) |
| | 12 | Processor standby/on button (PROCESSOR ⏻) |
| | 13 | Muting button (MUTING) |
| | 14 | Audio standby button (AUDIO ⏻) |
| | 15 | Input select buttons (TV, VCR, TAPE, CD, TUNER/BAND, DVD) |
| | 16 | ▶▶/▶▶▶▶ button (▶▶/▶▶▶▶) |
| | 17 | Cursor/select buttons |
| | 18 | Menu button (MENU) |
| | 19 | Test button (TEST) |
| | 20 | Delay time/level adjust buttons (–, +) |
| | 21 | Direct tuning/disc enter button (DIRECT TUNING/DISC ENTER) |
| | 22 | ≥10/– button (≥10/–) |
| | 23 | Numeric buttons |
| | 24 | Disc/deck 1/2 select button (DISC/DECK 1/2) |
| | 25 | TV/AV select button (TV/AV) |
| | 26 | Volume buttons (–VOL+) |

Equipment connections

Make sure that the power supply for all components has been turned off before making any connections.
To connect equipment, refer to the appropriate operating instructions.

NOTE

Do not place books, etc., on the top of this unit or block the heat radiation vents in any way.

Connecting audio equipment



Stereo phone cable (not included)
White (L)
Red (R)

Tape deck (not included)
REC (IN)
PLAY (OUT)

CD player (or CD changer) (not included)
OUTPUT

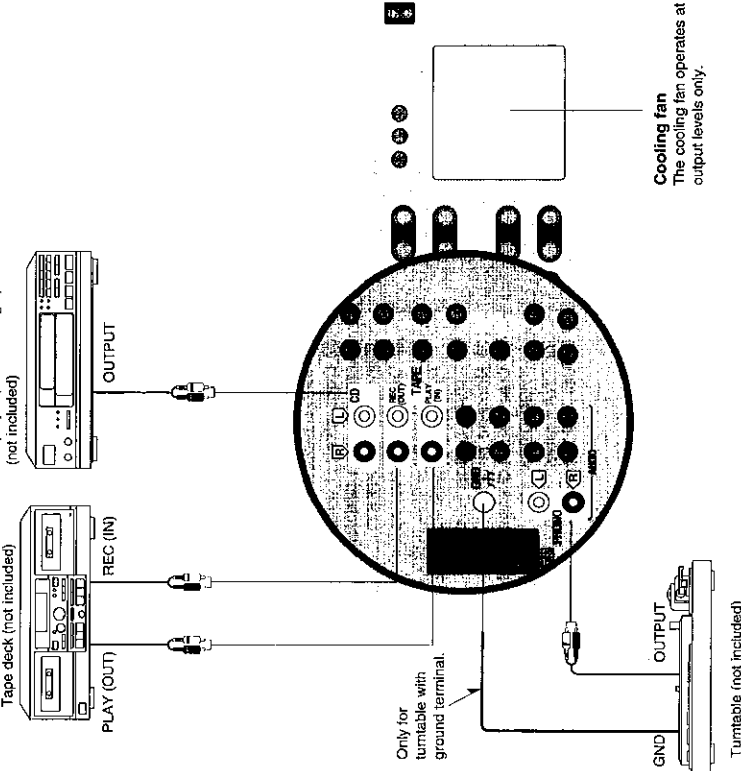

Cooling fan
The cooling fan operates at high power output levels only.

Turntable (not included)

Equipment connections



Connecting a DVD player

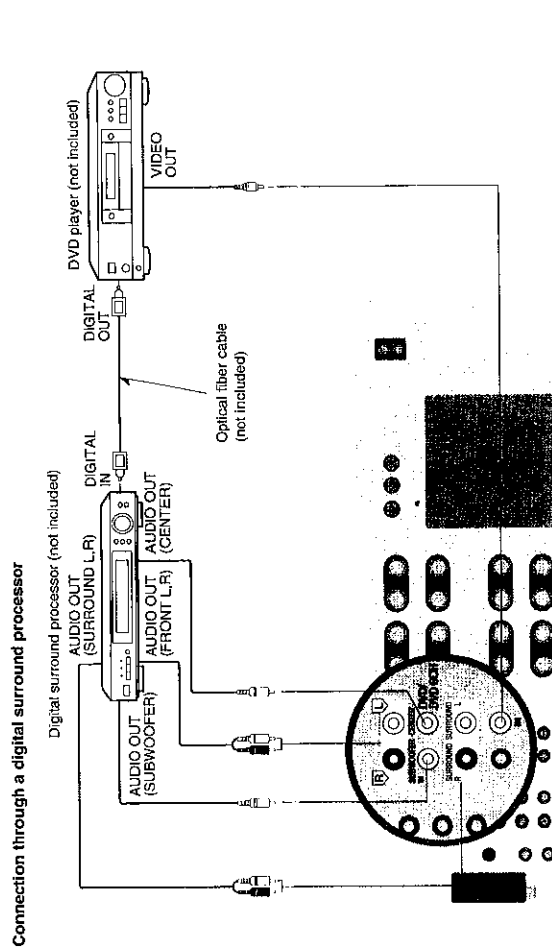

Direct connection of the DVD player

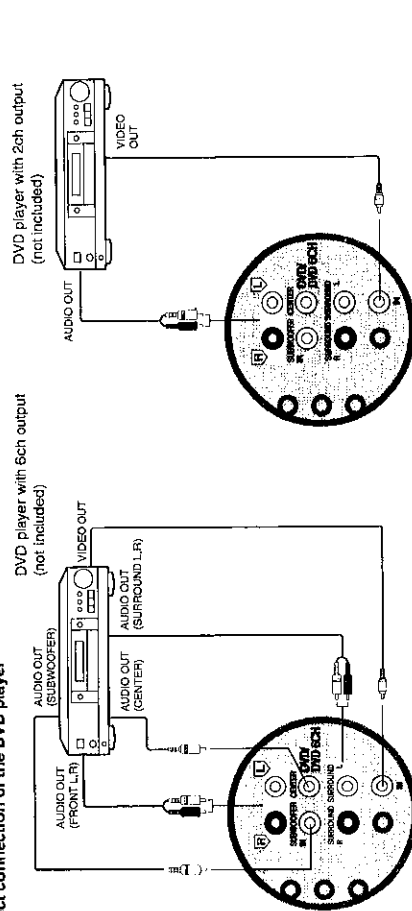

Connecting video equipment

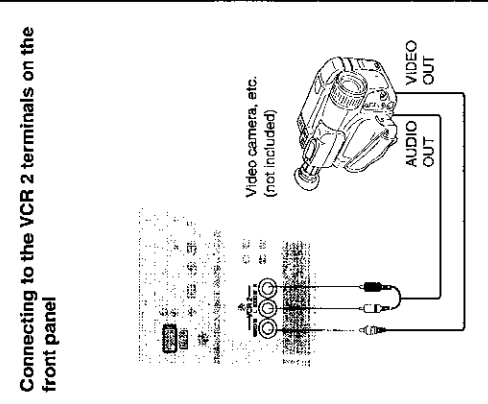
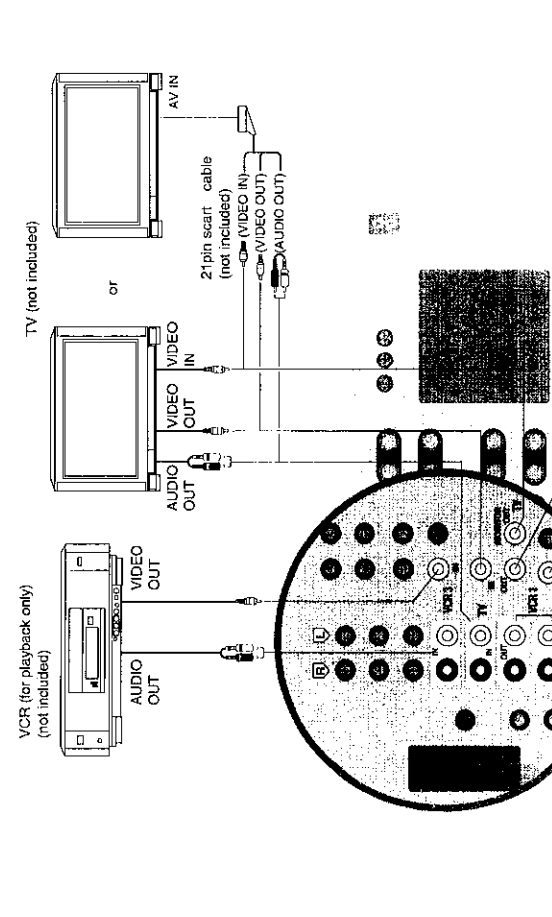

Speaker connections

Placement of speakers

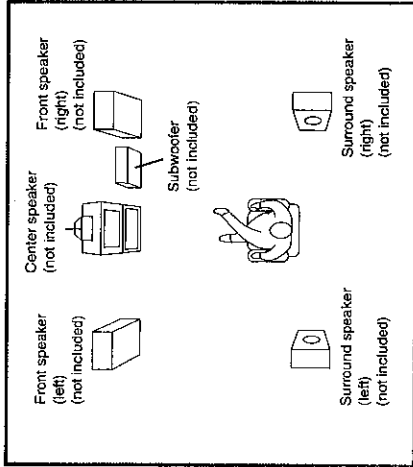

Front speakers
Place the front speakers on the left and right of the TV at seated ear height so that there is good coherency between the picture and sound.

Center speaker
Place this speaker underneath or above the center of the TV. Aim the speaker at the seating area.

Surround speakers
Place these speakers on the side of or slightly behind the listener, and about one meter higher than ear level.

Subwoofer
The subwoofer can be placed in any position as long as it is at a reasonable distance from the TV.
Note that some experimentation can yield the smoothest, low frequency performance. Placement near a corner can increase the apparent output level, but can result in unnatural bass.

Connecting speakers

Other connections are possible depending on your speaker system. See your speaker system's operating instructions for details.

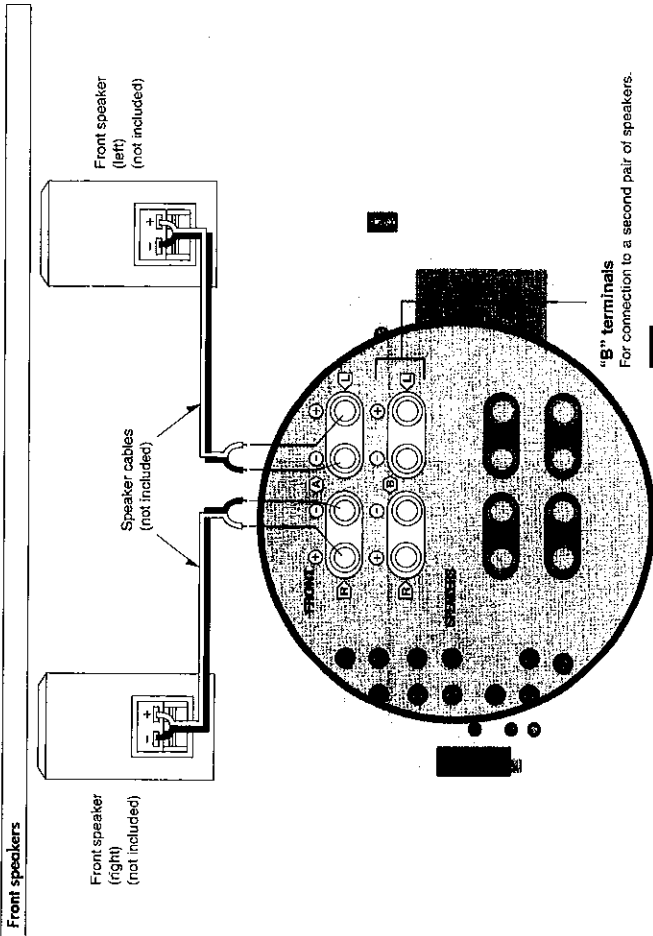

Connections to/from S-VIDEO terminals

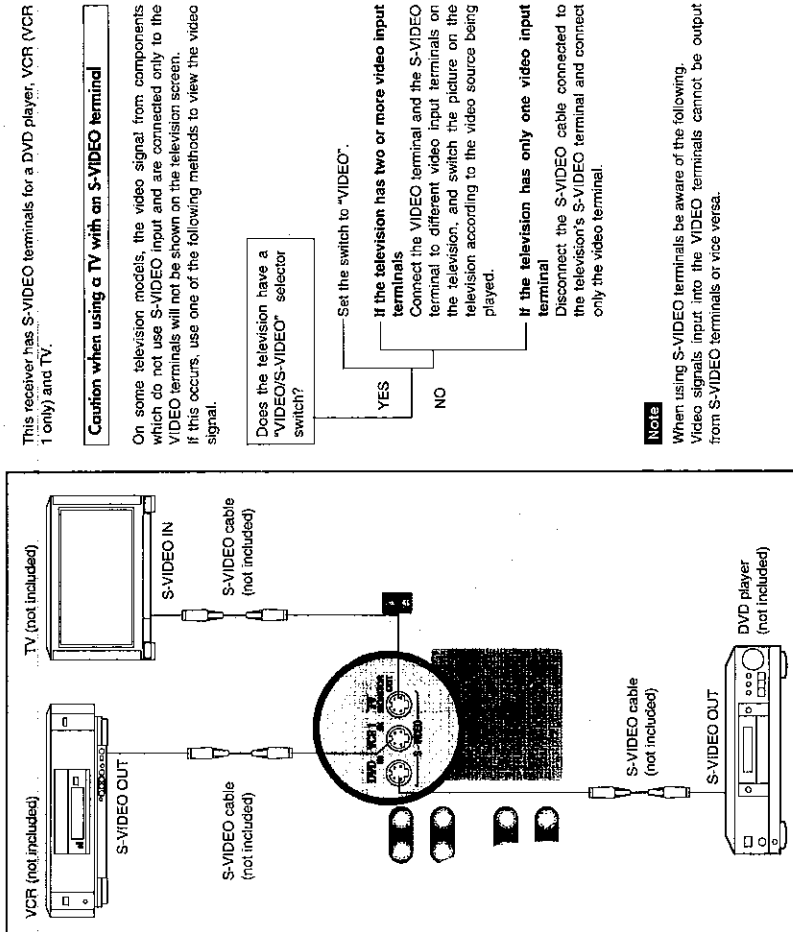

This receiver has S-VIDEO terminals for a DVD player, VCR (VCR 1 only) and TV.

Caution when using a TV with an S-VIDEO terminal

On some television models, the video signal from components which do not use S-VIDEO input and are connected only to the VIDEO terminals will not be shown on the television screen. If this occurs, use one of the following methods to view the video signal.

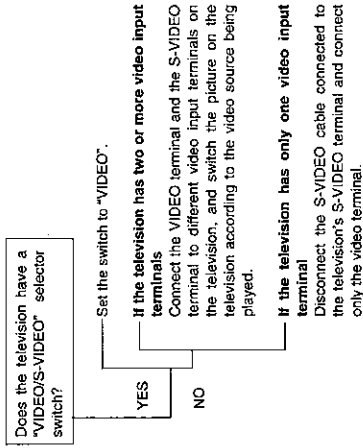

Notes

When using S-VIDEO terminals be aware of the following. Video signals input into the VIDEO terminals cannot be output from S-VIDEO terminals or vice versa.

AC power supply cord

Connect this cord only after all other cables and cords are connected.

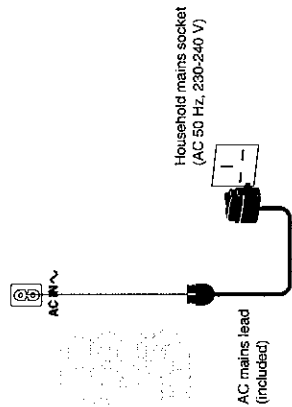

Insertion of connector

Even when the connector is perfectly inserted, depending on the type of inlet used, the front part of the connector may jut out as shown in the drawing. However there is no problem using the unit.

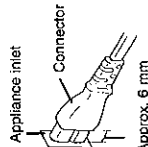

(For United Kingdom only)
BE SURE TO READ THE CAUTION FOR THE AC MAINS LEAD ON PAGE 3 BEFORE CONNECTION.

Speaker connections

Other speakers

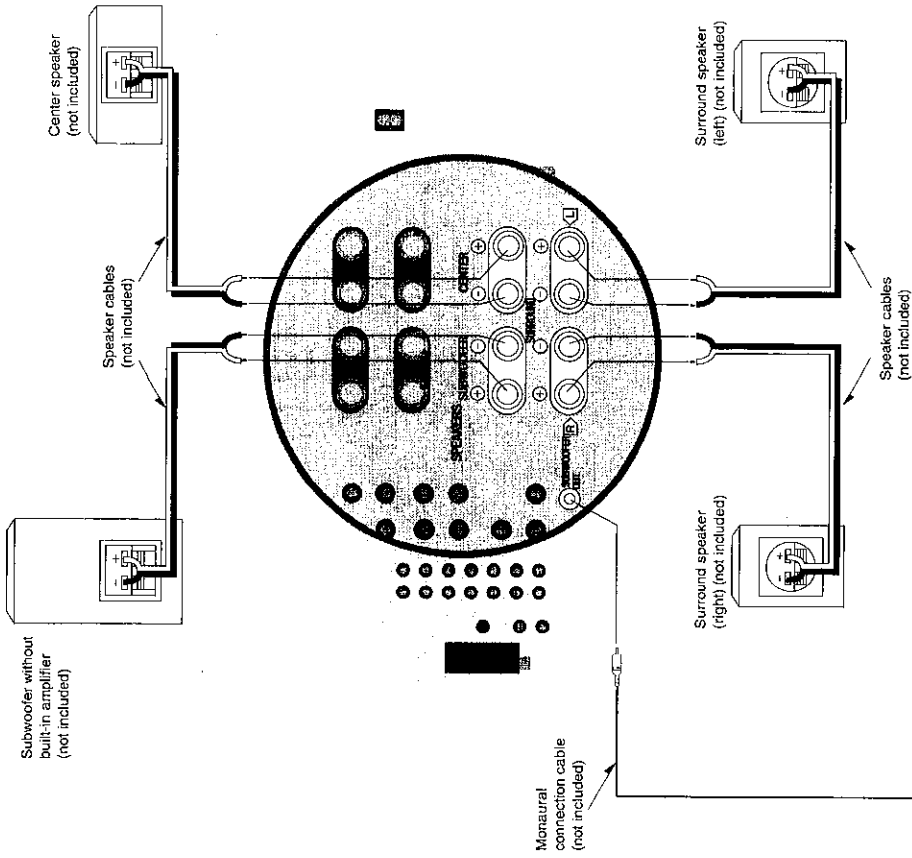

Note

For subwoofer

You only need to make one of the shown connections to get sound from the subwoofer.

Speaker impedance:

Center speaker:	6-16 Ω
Surround speaker:	6-16 Ω
Subwoofer:	6-16 Ω

Bi-wiring connection

Note

When bi-wiring, use speakers designed for that purpose that have combined impedance of 6-16 Ω.

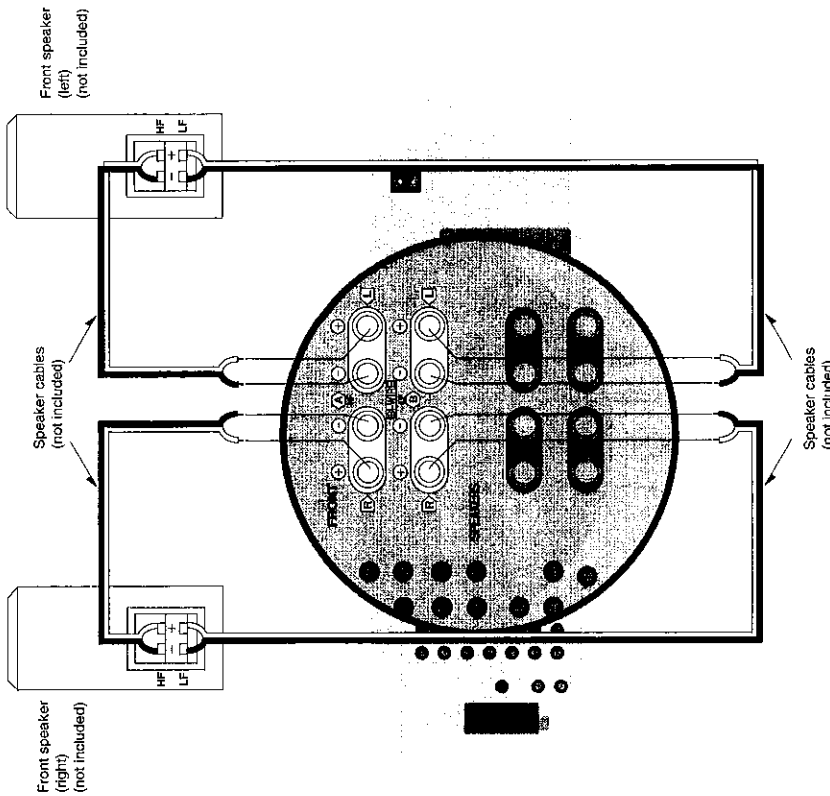

Speaker impedance:

A or B:	4-16 Ω
A and B:	6-16 Ω
BI-WIRE:	6-16 Ω

Connecting the cables

- 1
- 2
- 3

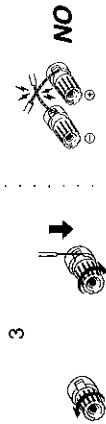

Note

To prevent damage to circuitry, never short-circuit positive (+) and negative (-) speaker wires.

NO



Basic operations

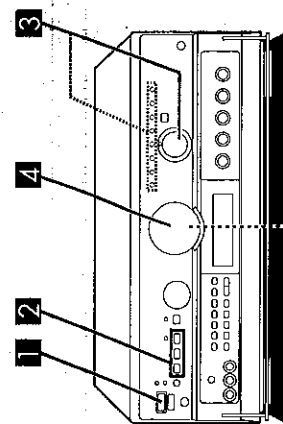

Before operation, set [VOLUME] to the "MIN" position.

- 1 Press [ϕ /I].
- 2 Select the speaker system(s) to be used.
The buttons A, B and **SWIRE** refer to the speaker terminals at the rear of the unit.
If the button is pressed once more, the indicator will switch off and no sound will be heard from the speakers.
SWIRE and A, or **SWIRE** and B cannot both be used at the same time.
- 3 Turn [INPUT SELECTOR] to select and start the desired source.
(Refer to the appropriate operating instructions for details.)

The indicator corresponding to the selected source lights and the source is shown on the display.
The selected source and "INPUT" will be shown on the display.

TAPE (MONITOR): To listen to cassette tapes
VCR 1: To watch video tapes (VCR 1)
VCR 2: To watch TV or video tapes (VCR 2)
VCR 3: To watch video tapes (VCR 3)
DVD: To watch DVD
CD: To listen to compact discs
TUNER: To listen to radio broadcasts
PHONO: To listen to phono discs

NOTE

To watch a video (or DVD) or the TV, set the TV to either the TV mode or VIDEO mode.

- 4 Adjust the volume level.

For your reference

- If a Dolby Pro Logic mode has been selected
After displaying the selected source, the display will then change to show the Dolby Pro Logic mode and "INPUT" will go out.
If the source chosen was TUNER then the display will change again to show the frequency.
- If you are using VCR and you select TAPE, CD, TUNER, or PHONO
The picture will remain on the screen.
- The volume control
The volume control on this unit allows more gradual adjustment compared to past models, thus making it easier to make fine volume adjustments during normal use.

When you finish listening

Be sure to reduce the volume level, and switch the power to the standby condition by pressing [ϕ /I].

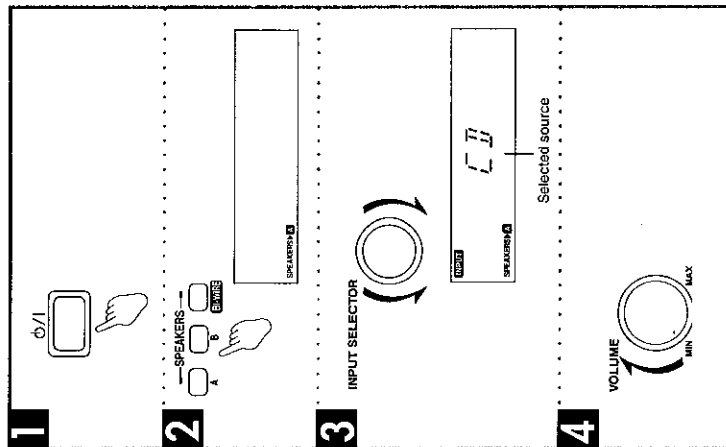

Basic operations

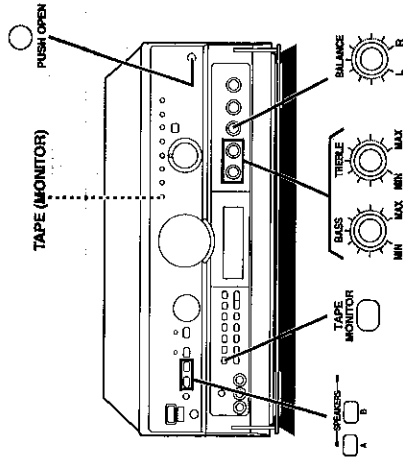

To open the front cover [A]

Press [PUSH OPEN].
Push the cover closed by hand.

For front speakers with an impedance under 6 Ω [B]

Press and hold [A] or [B] until "LOW IMP" lights up on the display.

If even one of the speakers being used has an impedance under 6 Ω , press and hold down either [A] or [B] for 4 seconds or more to set the impedance on the main unit to LOW.

(Press and hold down once again for 4 seconds or more to turn it off.)

Note that when "LOW IMP" is illuminated, speakers A and B cannot both be used at the same time.

To change speakers when "LOW IMP" is on:
e.g. To use speakers B, press [A] ("A" goes out), and then press [B] to activate speakers B.

The TAPE (MONITOR) indicator

This indicator lights in the following two situations:

1. While TAPE is selected.
2. While TAPE MONITOR is in use.

Tape monitor [C]

If [TAPE MONITOR] is pressed while a source other than TAPE is selected, the "TAPE (MONITOR)" indicator lights and the tape monitor comes on.

Sources other than tape can still be selected with [INPUT SELECTOR] while the "TAPE (MONITOR)" indicator is on.

Press [TAPE MONITOR] again to turn the tape monitor off.

(\rightarrow See "Making a recording" for details on how to use the tape monitor during recording.)

To adjust the tone quality

Turn [BASS] to adjust the low frequency sound.
Turn [TREBLE] to adjust the high frequency sound.

To adjust the sound balance

Turn [BALANCE] to adjust the left/right sound balance.

Dolby Pro Logic

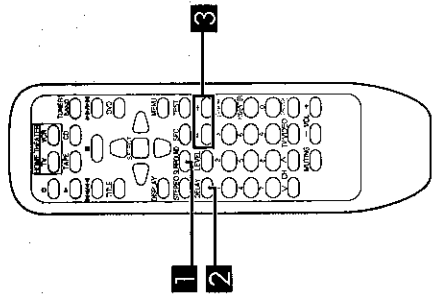

Adjusting the delay time

By remote control only

Adjust the sound from the surround speakers until the proper effect is produced.

1 Press [SURROUND].

NOTE

This procedure can be done only in the SURROUND mode.

2 Press [DELAY].

When the button is pressed, the current delay time is displayed.

3 Press [-] or [+] to set the time.

The delay time changes by 5 ms with each press, between 15 ms and 30 ms.

The standard setting is 20 ms.

To calculate the delay time

- D₁: Distance from front speakers
- D₂: Distance from surround speakers
- If D₁ is equal to or less than D₂, Set to 15 ms.
- If D₁ is less than D₂, Start at 15 ms and increase by 5 ms for every 1.5 m of difference between D₁ and D₂.

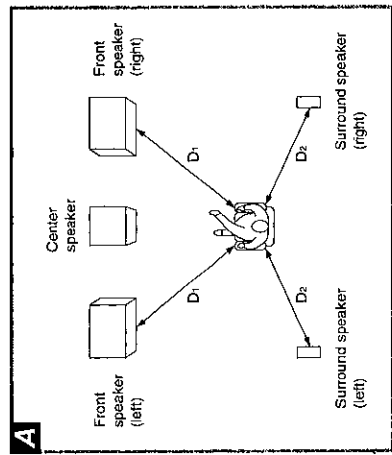
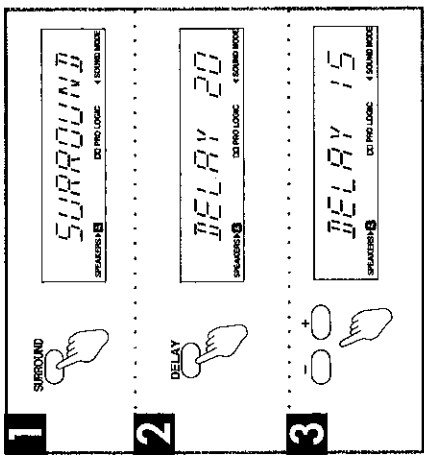

Manufactured under license from Dolby Laboratories Licensing Corporation. Dolby, the double-D symbol and "PRO LOGIC" are trademarks of Dolby Laboratories Licensing Corporation.

Dolby Pro Logic

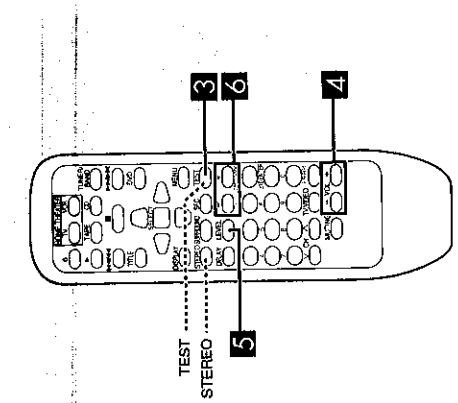

By remote control only

Press [TEST] to output a test signal.

The speaker outputting the test signal is displayed while the test is running.

- L: Front speaker (left)
- C: Center speaker
- R: Front speaker (right)
- S: Surround speakers

The subwoofer is muted while testing.

In the PHANTOM mode, the center speaker is OFF, so there is no center test signal and "C" is not displayed.

By remote control

Press [VOL (-) or (+)] to set the volume level normally used for enjoying the source.

By remote control only

Press [LEVEL] to select the center or surround speakers.

By remote control only

Press [-] or [+] to adjust the output level to the same apparent level as the front speakers.

- : Decrease the output level.
- +: Increase the output level.
- Output level can be varied within a range of -12 dB to +12 dB with front speaker output level serving as the zero point.

NOTE

During steps 5 and 6 above the test signal sequence is interrupted and the signal will only come from the selected speaker. The sequence will resume when adjustments are stopped.

Repeat step 5 and 6 for each speaker channel.

To stop the test signal

Press [TEST].

To turn off the Dolby Pro Logic systems

Press [STEREO].

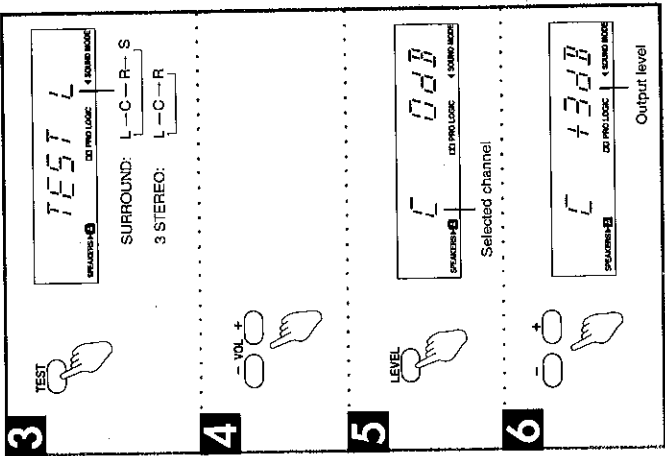

Dolby Pro Logic

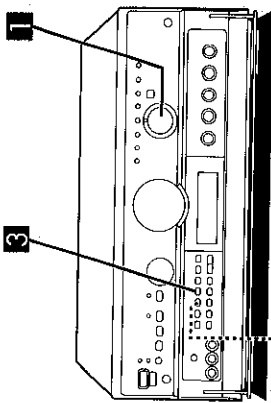

Ensure you have your speakers set up in either of the following ways.

- The front speakers are connected to the A terminals (➔ page 14) and "SPEAKERS A" is selected.
- The front speakers are bi-wired (➔ page 15) and "SPEAKERS BI-WIRE" is selected.

1 Turn [INPUT SELECTOR] to select the desired source.

2 Start the source.

3 Select the mode.
The selected reproduction mode appears on the display. (➔ Page 29 for descriptions of the modes.)

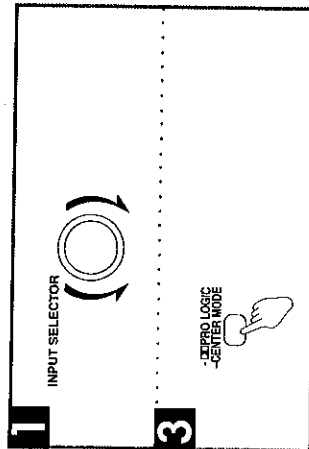

To turn off the Dolby Pro Logic modes
Press [STEREO].

NOTE

- These modes cannot be turned on while "SPEAKERS B" is on. These modes are automatically switched to STEREO if SPEAKERS B is selected and the modes in the memory for all sources will also be switched to STEREO. The modes must be selected again for all sources when SPEAKERS B is turned off again.
- BI-AMP and Dolby Pro Logic cannot be used at the same time. If you are using BI-AMP and you select a Dolby Pro Logic mode, BI-AMP will turn OFF and the "BI-AMP" indicator will go out.

DVD 6CH INPUT mode

Use this mode when playing back 6 channel discrete sources such as Dolby Digital and DTS. To use this mode connect a DVD player, digital surround processor or any other component that has 6 channel discrete output capabilities.

Dolby Digital, DTS and other 6 channel discrete sources are recorded with each speaker channel discrete from the other. Depth, movement, position and other characteristics are maintained, so using this mode will make you feel as if you were at a movie theater.

Ensure you have your speakers set up in either of the following ways.

- The front speakers are connected to the A terminals and "SPEAKERS A" is selected.
- The front speakers are bi-wired and "SPEAKERS BI-WIRE" is selected.

1 Turn [INPUT SELECTOR] to select "DVD."

2 Press [DVD 6CH INPUT] to select "DVD 6CH."
Changes as follows, each time the button is pressed.
DVD 6CH = DVD (2CH)

If you press this button while another source (CD, PHONO, etc.) is selected, the receiver switches the source to DVD and engages the DVD 6CH INPUT mode.

3 Start the desired source.

Follow your equipment's operating instructions.

Note

- This mode cannot be turned on while SPEAKERS B is on. This mode is automatically cancelled if SPEAKERS B is selected and the modes in the memory for all sources will also be switched to STEREO. The modes must be selected again for all sources when SPEAKERS B is turned off again.
- You cannot select Dolby Pro Logic modes while in the DVD 6CH INPUT mode.
- BI-AMP and DVD 6CH INPUT cannot be used at the same time. If you are using BI-AMP and you select DVD 6CH INPUT, BI-AMP will turn OFF and the "BI-AMP" indicator will go out.

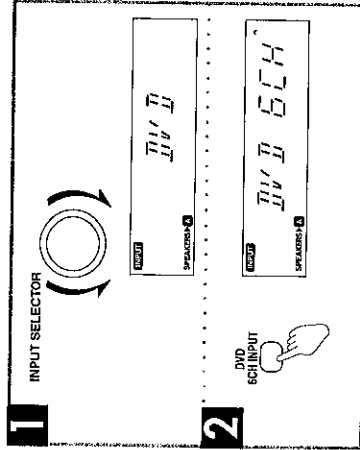
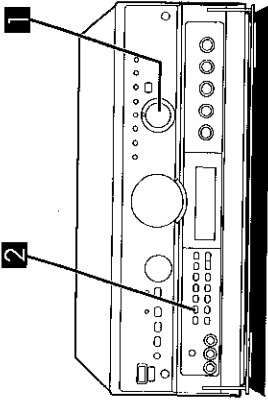

Other functions

To mute the sound level

by remote control only

Press [MUTING].

The message "MUTING ON NOW" runs repeatedly from right to left across the display as long as the muting function is on.

Press once again to return to the previous volume level.

Note

Muting is cancelled when the receiver is turned off.

To listen through headphones

- 1 Reduce the volume level.
- 2 Connect the headphones.
- 3 Adjust the volume level.

Turn the speakers off when using headphones. Turning the speakers off automatically engages STEREO mode and ensures no sound is heard from the subwoofer. If either SURROUND or 3 STEREO is used, the sound heard through the headphones will seem unusual.

Note

Avoid listening for prolonged periods of time to prevent hearing damage.

When using the VCR 2 terminals (front panel)

This button can be used only when TV/VCR 2 is selected as the input source.

The TV, VCR 2 input select button works for both TV input and input from the source connected to the front panel "VCR 2" terminals.

Select "TV" or "VCR 2".

To turn off the blue light

by remote control only

Turning off the blue light can improve video viewing in dark or dimly lit rooms.

- 1 Press [MUTING].
- 2 (within 3 seconds) Press [DISPLAY].
- 3 Press [MUTING] to cancel the muting function.

Repeat to turn on again.

Note

This light comes on when the power is turned on.

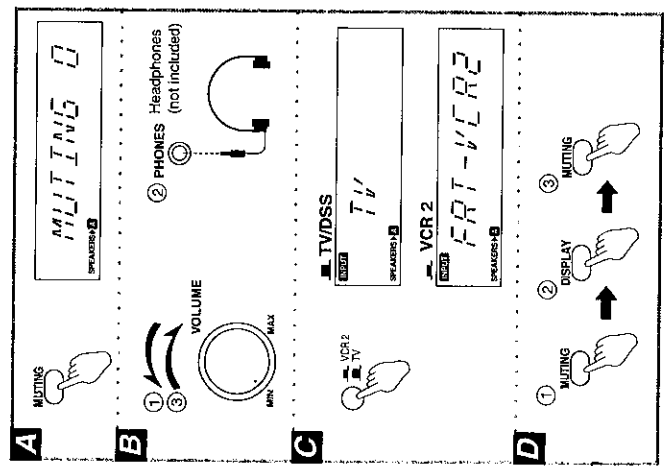
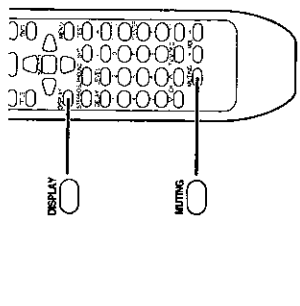
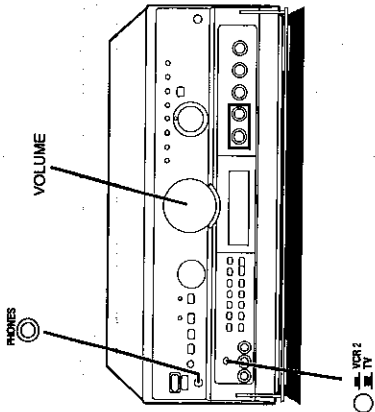

VGCA mode

This unit features a state-of-the-art variable gain control amplifier (VGCA). This feature cuts down greatly on noise encountered during normal use.

- 1 Turn [INPUT SELECTOR] to select the source.
- 2 Press [VGCA]. The "VGCA" indicator lights when "VGCA" is selected. "VGCA ON" is displayed, then "TONE DEFEAT / DISPLAY OFF" scrolls across the display. The display then turns off. If TUNER was chosen as the source, the current frequency is shown.
- 3 Start the desired source. Follow your equipment's operating instructions.

To confirm the current display

Press [STEREO]. The display comes on for about 3 seconds.

For your reference

You can set the VGCA mode for each source. Each source will retain the selected mode.

Note

- Tone quality (bass and treble) cannot be adjusted in this mode.
- Dolby Pro Logic modes cannot be selected while VGCA is on. These modes are also cancelled when VGCA is turned on and STEREO mode is engaged.

To have the display on constantly

The display is turned off while VGCA is on to cut down on unnecessary noise. Do the following if you would prefer to have the display on.

- 1 Turn [INPUT SELECTOR] to select a source other than TUNER.
- 2 Press [VGCA] to turn VGCA on.
- 3 Press and hold [VGCA] for about 4 seconds until the display comes on.

This setting remains active even if the unit is turned off. Repeat the procedure to turn the display off again.

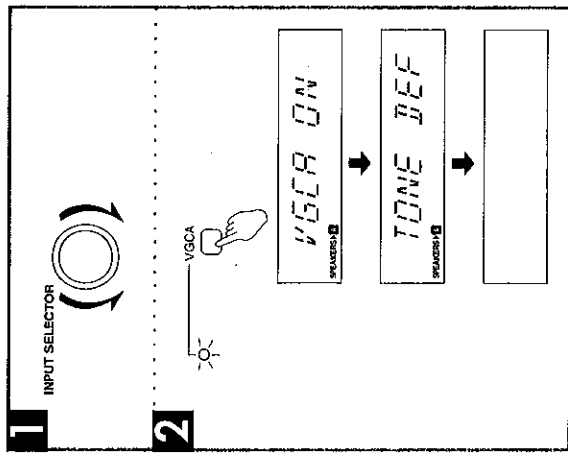
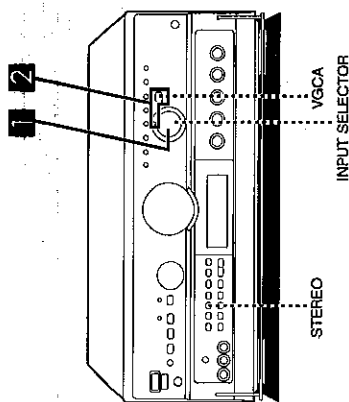

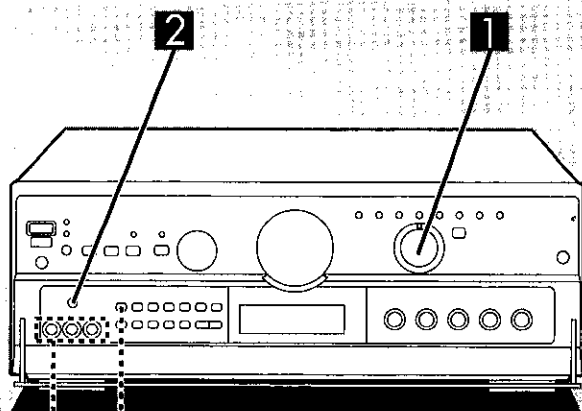

VCR 2 TAPE MONITOR

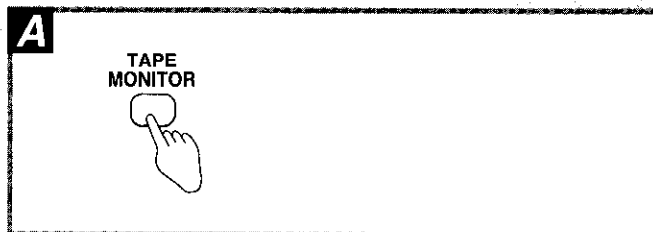
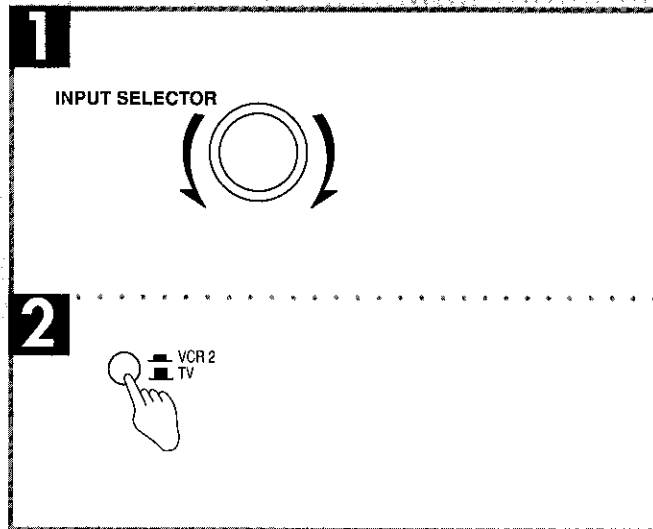

Making a recording

Note

When you select DVD 6CH INPUT mode, only sound from the front left and right speakers is recorded.

To record all 6 channels

Set the playback mode on your DVD player or decoder to 2 channel (stereo) mode.

For details, see the instruction manual that came with the connected equipment.

Recording to a tape deck or VCR

You can record to a tape deck connected to TAPE REC (OUT) or to a VCR connected to VCR 1 OUT.

See the recording unit's operating instructions for details on how to prepare it for recording.

When recording with a tape deck, you can record any source except TAPE.

When recording with a VCR, you can record any source except TAPE or VCR 1.

Note

Recording from the tape deck to the VCR is not possible.

- 1** Turn [INPUT SELECTOR] to select the source to be recorded.
- 2** If you selected TV/VCR 2 in step 1, set [TV, VCR 2] to the required position.
- 3** Begin recording.
Follow your recording unit's operating instructions.
- 4** Start the source to be recorded.
Follow your equipment's operating instructions.

To monitor sound being recorded onto a tape deck **A**

It is possible to check the sound being recorded if your tape deck is a 3 head system.

Press [TAPE MONITOR] on this unit and set the monitor button on the tape deck to "TAPE."

Press [TAPE MONITOR] once again to turn it off.

For your reference

Use the VCR 2 terminals on the front of the unit when dubbing from a video camera.

■ Operation Checks

"ATTENTION SERVICER" Some chassis components may have sharp edges. Be careful when disassembling and servicing.

1. This section describes procedures for checking the operation of the major printed circuit boards and replacing the main components.
2. For reassembly after operation checks or replacement, reverse the respective procedures. Special reassembly procedures are described only when required.
3. Select items from the following index when checks or replacement are required.

• Contents

	page
• Checking Procedure For Each Major P.C.B.	15 ~ 17
• Main Component Replacement Procedures	17 ~ 18

■ Checking Procedure For Each Major P.C.B.

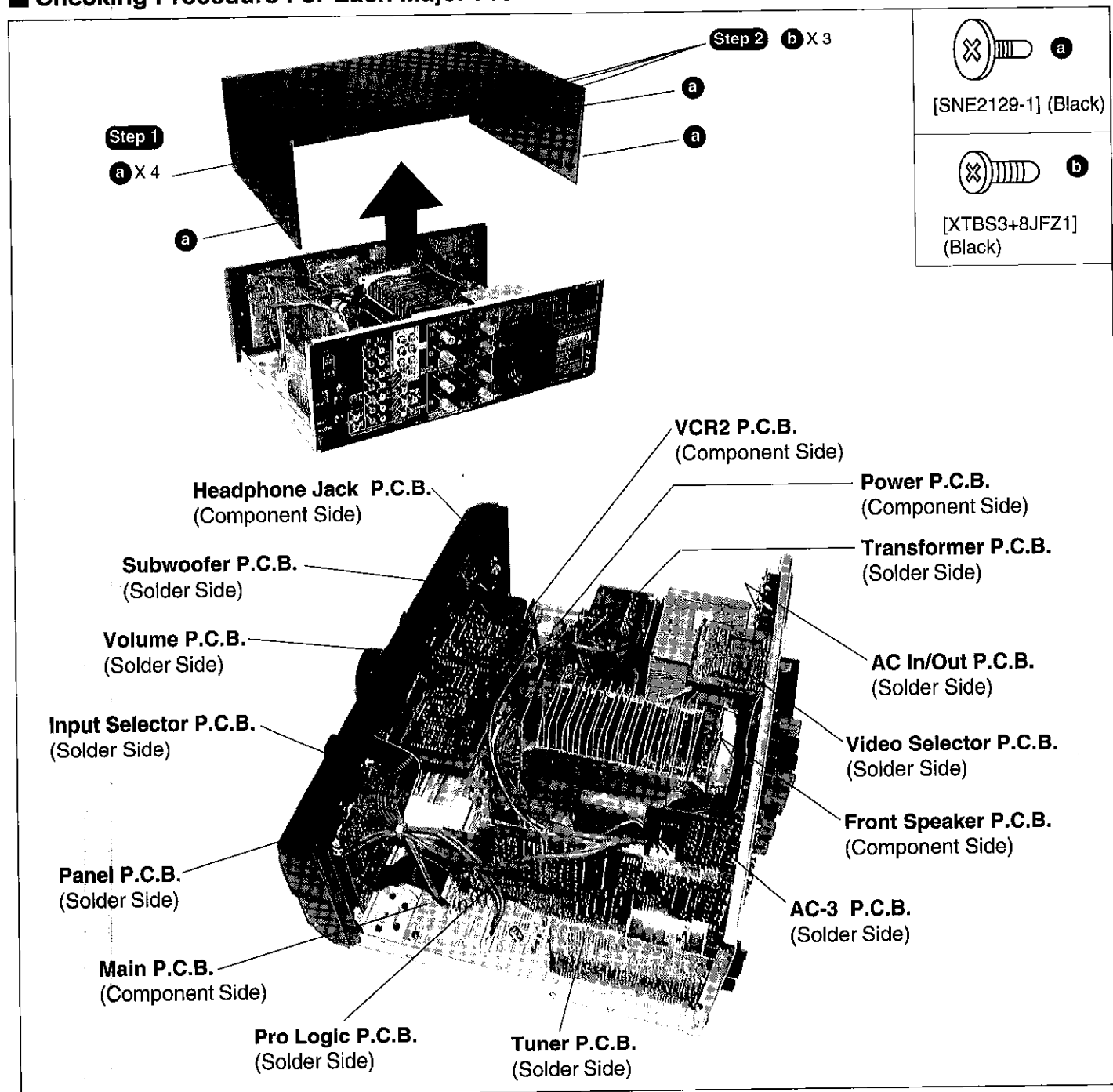

To remove Front Panel

Step 1
Remove the top cabinet.

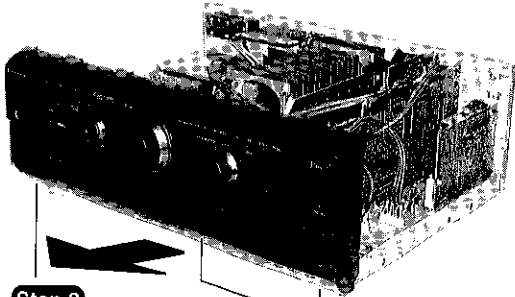

Step 2
b X 3

Step 3
Remove the Front Panel in the direction of arrow.

Input Selector P.C.B.

Step 8
Remove Subwoofer P.C.B. and Input Selector P.C.B. to check on Blue LED P.C.B. (Right/Left).

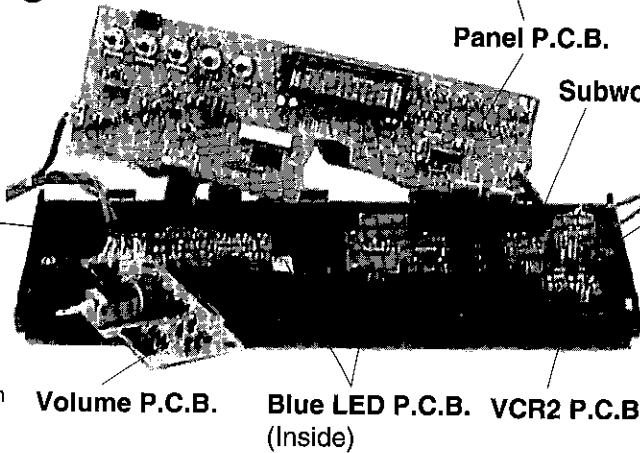

Step 4
Remove all Knobs and Nuts from Front Panel.

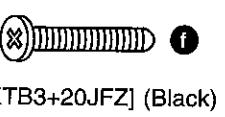
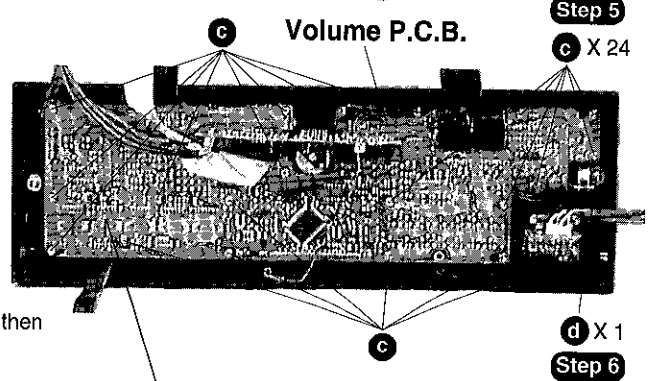
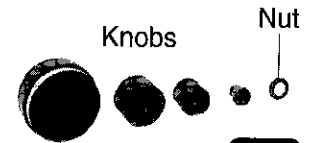

To remove Rear Panel

Step 4
Release the AC In/Out P.C.B. catches and the fan motor connector, then pull out the rear panel in the direction of arrow.

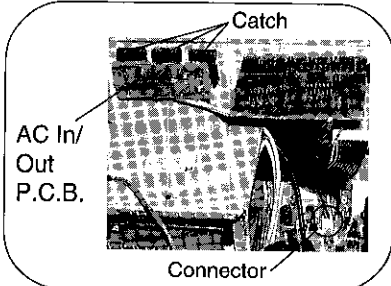

Step 1
Remove the top cabinet.

Step 2
Remove the front panel.

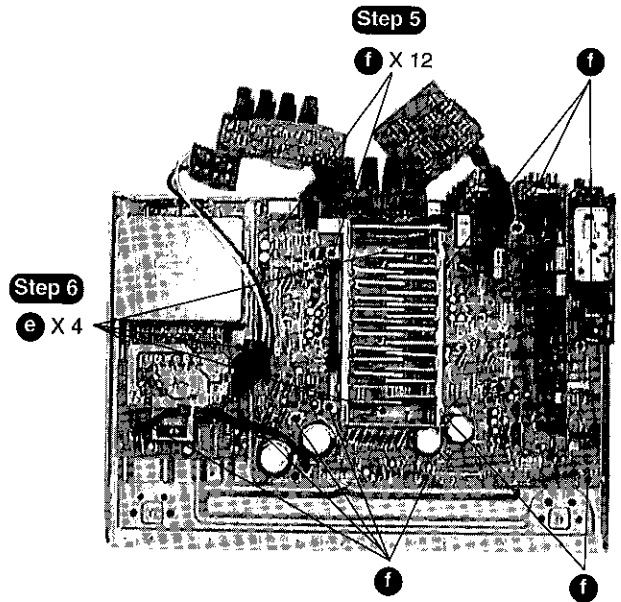
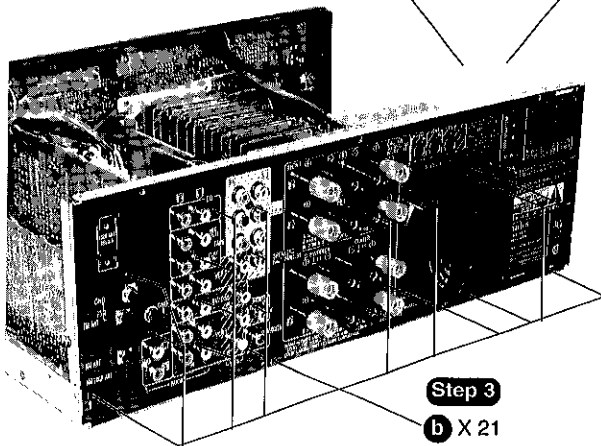

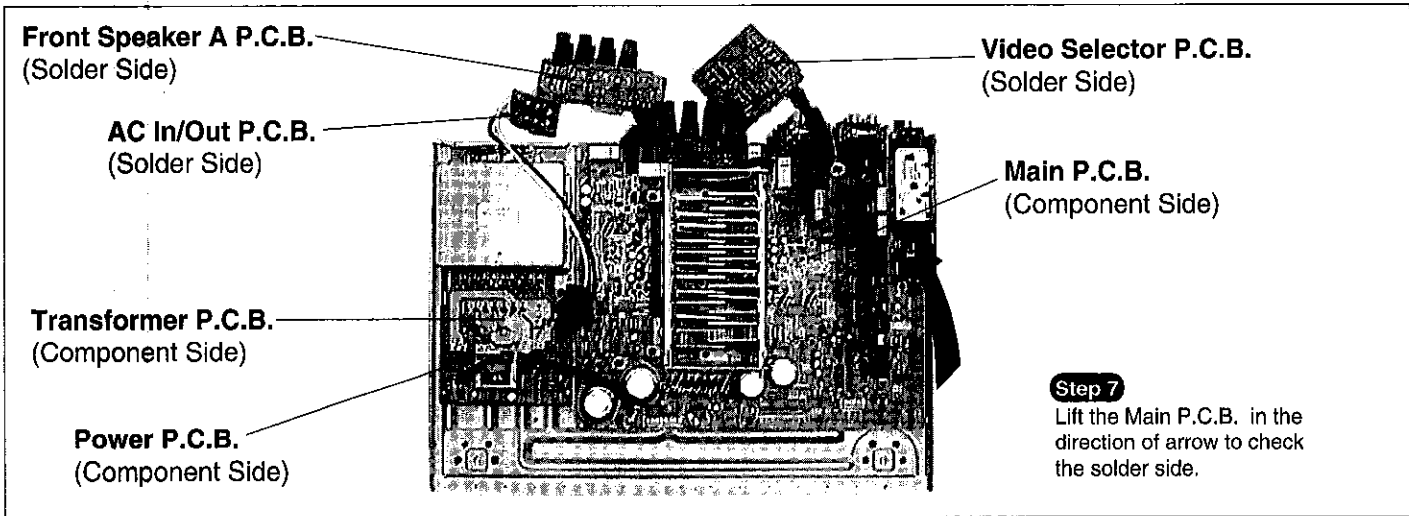

Main Component Replacement Procedures

1. Replacement of the Power IC and Regulator Transistor

Step 1
Remove the top cabinet.

Step 2 Cut the joints as shown below. (8 joints)

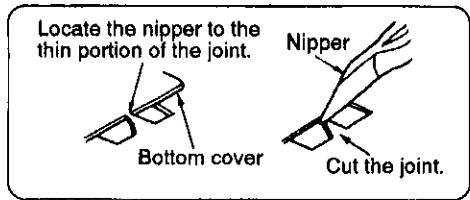

Step 3 Fold the joints. (8 joints)

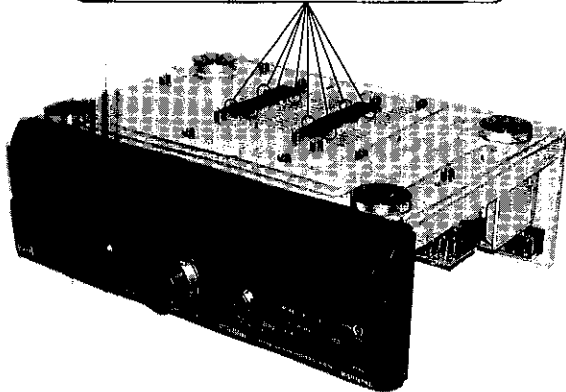
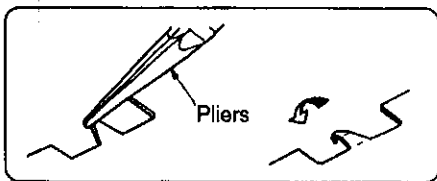

Step 4
Desolder the terminals of Power IC and Regulator Transistor.

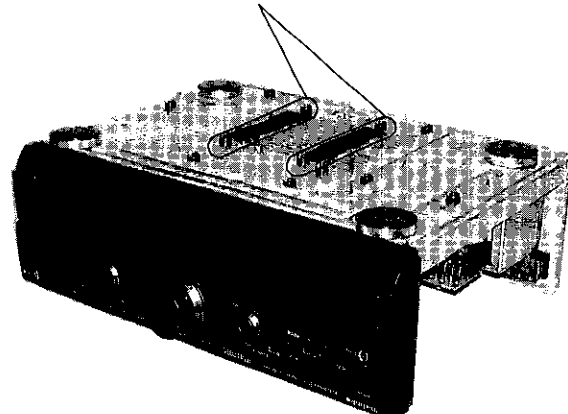

Step 5

Remove all screws (b) for the Tuner, AC-3 and Pro Logic P.C.B.'s at the Rear Panel and pull out these P.C.B.'s from the Main P.C.B.

Power IC (IC651)
[RSN310R36-P]

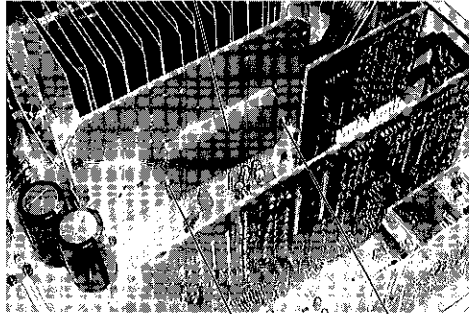

Step 6 g X 2

g

Power IC (IC601)
[RSN310R36-P]

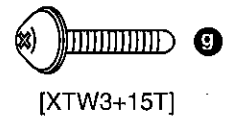
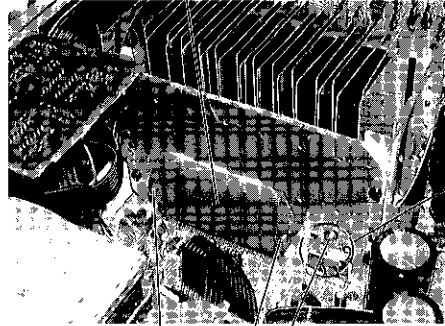

Regulator transistor (Q701, Q708)
[2SD2374PQAU, 2SB1548PQAU]

Step 7

g X 3



The PROTO Offset Screwdriver No. 34-1/4 is recommended for use in the application above.

Installation of the bottom cover after replacement

Step 1

Bottom cover

* Upset the bottom cover



Ribs

Lugs

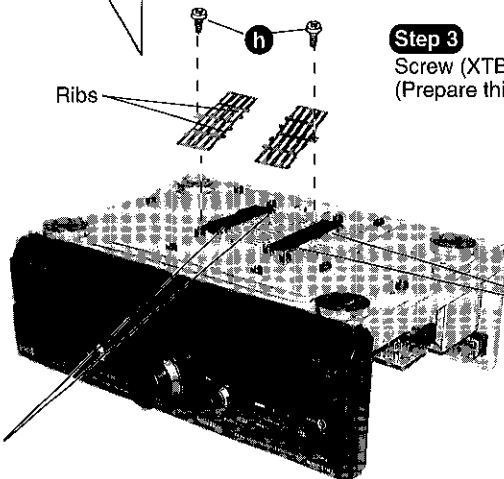

Step 3

Screw (XTB3+8J)
(Prepare this screw to fix the bottom cover.)

Step 2

Align the ribs of bottom cover into the lugs.



[XTB3+8J] (Black)

CAUTION

1. After replacing the power IC or regulator transistor, apply a sufficient quantity of compound grease (RFKX0002/SZZ0L15) between the heat sink and the power IC or regulator transistor (Radiation of power IC).
2. Tighten enough the screws (g) after replacing the power IC and regulator transistor. Otherwise, the heat radiation works little.
3. When installing or removing the power IC or transistor holder, be sure to use an offset screwdriver.

- A long straight screwdriver cannot be used for removing or mounting the screws since its long grip interferes with the neighbouring P.C.B. (See Fig.1)
- A short straight screwdriver may be used for removal, but cannot be used for mounting because the limited space in the unit will not allow sufficient tightening torque.(See Fig.2)

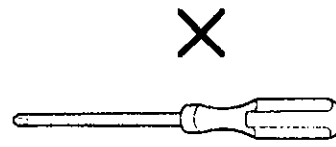

A long straight screwdriver

Fig.1

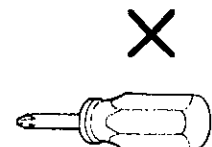

A short straight screwdriver

Fig.2

- Insufficient tightening will cause poor heat dissipation from the power IC and regulator transistor and, in the worst case, may lead to their thermal breakdown.

■ Terminal Functions Of ICs

• IC901 (M38B57M6123F) System Micro-computer

Pin No.	Mark	I/O	Function
1~2	KEY2~KEY1	I	Key Input 1 ~ 2
3	THERM/OVLD1	I	Thermal/Over load input 1
4	KEY4	I	Key Input 4
5	THERM/OVLD2	I	Thermal/Over load input 2
6	FM_ST	I	Stereo signal detect terminal
7	VALUE	-	No connection
8	RDS_DI	I	Control of RDS IC (ST) stereo signal
9	REMOTE	I	Remote control terminal
10	RESET	-	Reset detect terminal
11	RDS_CK	I	Control of RDS IC (CK) clock signal
12	RDS_DT	I	Control of RDS IC (DT) data signal
13	GND	-	GND terminal
14	XIN	-	Crystal oscillator terminal (4 MHz)
15	XOUT	-	Crystal oscillator terminal (4 MHz)
16	VDD (+4.9V)	-	Power supply terminal +5V
17	LED_CK	O	LED driver IC (CK) clock signal
18	LED_DATA	O	LED driver IC (DT) data signal
19	SFC 1	I	SFC mode encoder input 1
20	SFC 2	I	SFC mode encoder input 2
21	SEL1	I	Selector encoder for input 1
22	HOLD	I	Blackout detection terminal
23	SEL2	I	Selector encoder for input 2
24	TV_VCR2	I	VCR2 control input
25	RELAY	-	Relay control output
26	LOUDNESS	O	ABS control output
27	6ch_ST	O	6 ch sw control output (ST)
28	VEE (-22V)	-	Power supply for FL driver
29	S/C_SP	O	Surround/Center speaker control output

Pin No.	Mark	I/O	Function
30	SP_B	O	Speaker B control output
31	SP_A	O	Speaker A control output
32	AF_MUTE	O	Muting control output
33~48	SEG16~SEG1	O	FL segment signal output
49~58	DEG1~DEG10	O	FL digit signal output
59	INIT_IN	I	Diode input initial settings
60	VOL_DOWN	O	Volume control output (Down)
61	VOL_UP	O	Volume control output (Up)
62	REC_MUTE	O	REC Mute control
63	IF_DATA	I	Serial data signal
64	LIMITTER	O	Power limiter control output
65	TNR_CE	O	Tuner control (CE) chip enable signal
66	SEL/TNR_CK	O	Selector/Tuner (CK) clock signal
67	SEL/TNR_DT	O	Selector/Tuner (DT) data signal
68	SEL_ST	O	Selector control terminal
69	MMD	O	MMD control terminal
70	SURR/OSD_CK	O	Surround control (CK) clock signal
71	SURR/OSD_DT	O	Surround control (DT) data signal
72	SURR_CE	O	Surround control (CE) chip enable signal
73	AVSS	-	GND for A-D converter
74	VREF	-	Reference voltage for A-D converter
75	SD	I	SD signal detect input
76	TV4CH	I	Surround mode selector input
77	RDS_CE	O	Control of RDS IC (CE) chip enable signal
78	VIDEO_C	I	Video selector control output C
79	VIDEO_B	O	Video selector control output B
80	VIDEO_A	O	Video selector control output A

■ Type Illustration of ICs, Transistors and Diodes

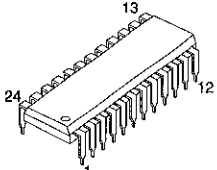
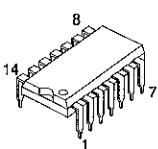
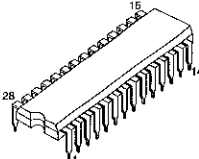
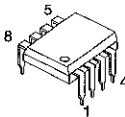
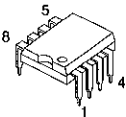
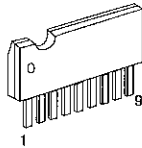
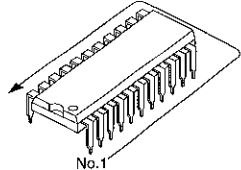
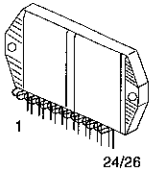
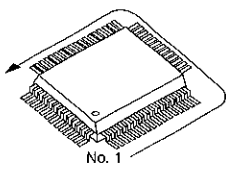
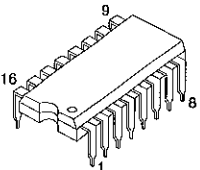
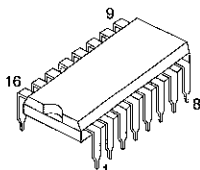
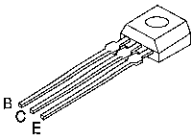
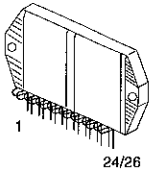
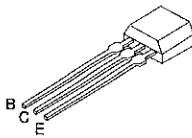
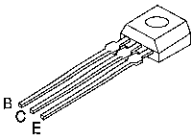
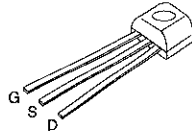
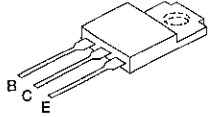
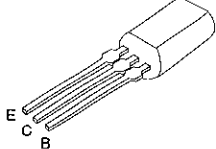
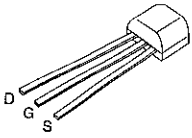
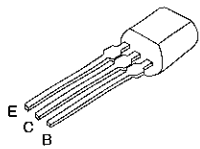
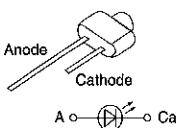
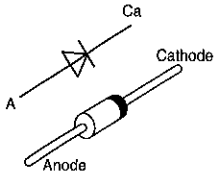
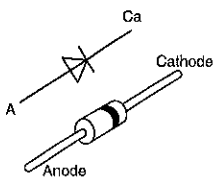
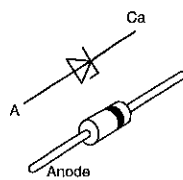
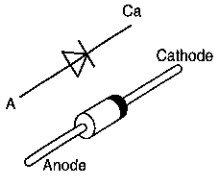
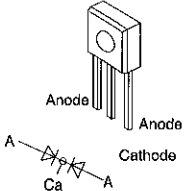
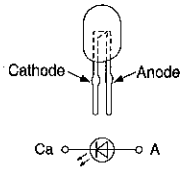







<p>LA1832A LC7218 LV1016L</p> 	<p>NJM2279D NJM2296D</p> 	<p>TC9163AN TC9162AN</p> 	<p>NJM4580DD</p> 	<p>AN6558F</p> 
<p>BA6218</p> 	<p>LA2786L (42Pin)</p> 	<p>RSN310R36-P</p> 	<p>M38B57M6123F (80 Pin)</p> 	<p>TC9214P</p> 
<p>BU2090</p> 	<p>2SC2785FETA 2SC2786MTA</p> 	<p>2SC2787FL1TA 2SC2787LTA 2SD1915FTA 2SC3311ARTA</p> 	<p>2SA933SSTA 2SA933SQRSTA</p> 	<p>2SC1740SQSTA RVTDTA114EST RVTDTA113ZST RVTDTA143XST RVTDTA143YST RVTDTA143ZST</p> 
<p>2SK544F-AC</p> 	<p>2SB1548PQAU 2SD2374PQAU</p> 	<p>2SC3940AQSTA 2SA1534AQRSTA</p> 	<p>2SK2880CTA</p> 	<p>2SB621AQSTA</p> 
<p>SLR325MCT31 SLR325VCT31</p> 	<p>1N5402BM21 RK306LFU1</p> 	<p>RVD1SS133TA 1SR35200TB MA700ATA 1SS291TA MA167ATA</p> 	<p>MTZJ10CTA MTZJ11CTA MTZJ15CTA</p> 	<p>MTZJ30DTA MTZJ3R0BTA MTZJ3R9ATA MTZJ4R7BTA MTZJ5R1BTA MTZJ5R6BTA MTZJ6R2BTA MTZJ6R8BTA MTZJ7R5CTA MTZJ8R2CTA</p> 
<p>SVC211SPA-AL</p> 	<p>LNG995PFBOA1</p> 			

■ Schematic Diagram

(All schematic diagrams may be modified at any time with the development of new technology)

Note :	• S301	:	TV/DSS and VCR2 mode switch	• S982	:	Loud switch
	• S946	:	Power switch	• S983	:	Tape monitor switch
	• S951	:	Band select switch	• S984	:	DVD 6CH mode switch
	• S952	:	Tuning decrease switch	• S985	:	Surround switch
	• S953	:	Tuning increase switch	• S986	:	Stereo switch
	• S955	:	Memory switch	• S988	:	Bi-wire switch
	• S956	:	Preset switch			
	• S958	:	Timer switch	• VR501	:	Motor volume control
	• S970	:	Search switch	• VR502	:	Balance control
	• S971	:	EON switch	• VR503	:	Subwoofer control
	• S972	:	PTY + switch	• VR511	:	Bass control
	• S973	:	PTY – switch	• VR512	:	Treble control
	• S974	:	DISPLAY MODE switch	• VR513	:	Bi-amp balance control
	• S976	:	6CH switch	• VR514	:	Subwoofer low-pass control
	• S980	:	Speakers A switch	• VR901	:	Input selector control
	• S981	:	Speakers B switch			

• Signal line

	: +B line		: AM signal line		: FM signal line
	: - B line		: AM OSC signal line		: FM OSC signal line
	: FM/AM signal line		: Main signal line		

- The voltage value and waveforms are the reference voltage of this unit measured by DC electronic voltmeter (high impedance) and oscilloscope on the basis of chassis. Accordingly, there may arise some error in voltage values and waveforms depending upon the internal impedance of the tester or the measuring unit.

< > FM

• Importance safety notice:

Components identified by  mark have special characteristics important for safety. Furthermore, special parts which have purposes of fire-retardant (resistors), high-quality sound (capacitors), low-noise (resistors), etc. are used. When replacing any of components, be sure to use only manufacturer's specified parts shown in the parts list.

Caution 1

IC, LSI and VLSI are sensitive to static electricity.

Secondary trouble can be prevented by taking care during repair.

- Cover the parts boxes made of plastics with aluminium foil.
- Ground the soldering iron.
- Do not touch the pins of IC, LSI or VLSI with fingers directly.
- Put a conductive mat on the work table.

SCHEMATIC DIAGRAM-1

A MAIN CIRCUIT
(P.C.Board on page 36)

— : +B Line ⇨ : Main Signal Line
 - - : -B Line ⇨ : FM/AM Signal Line

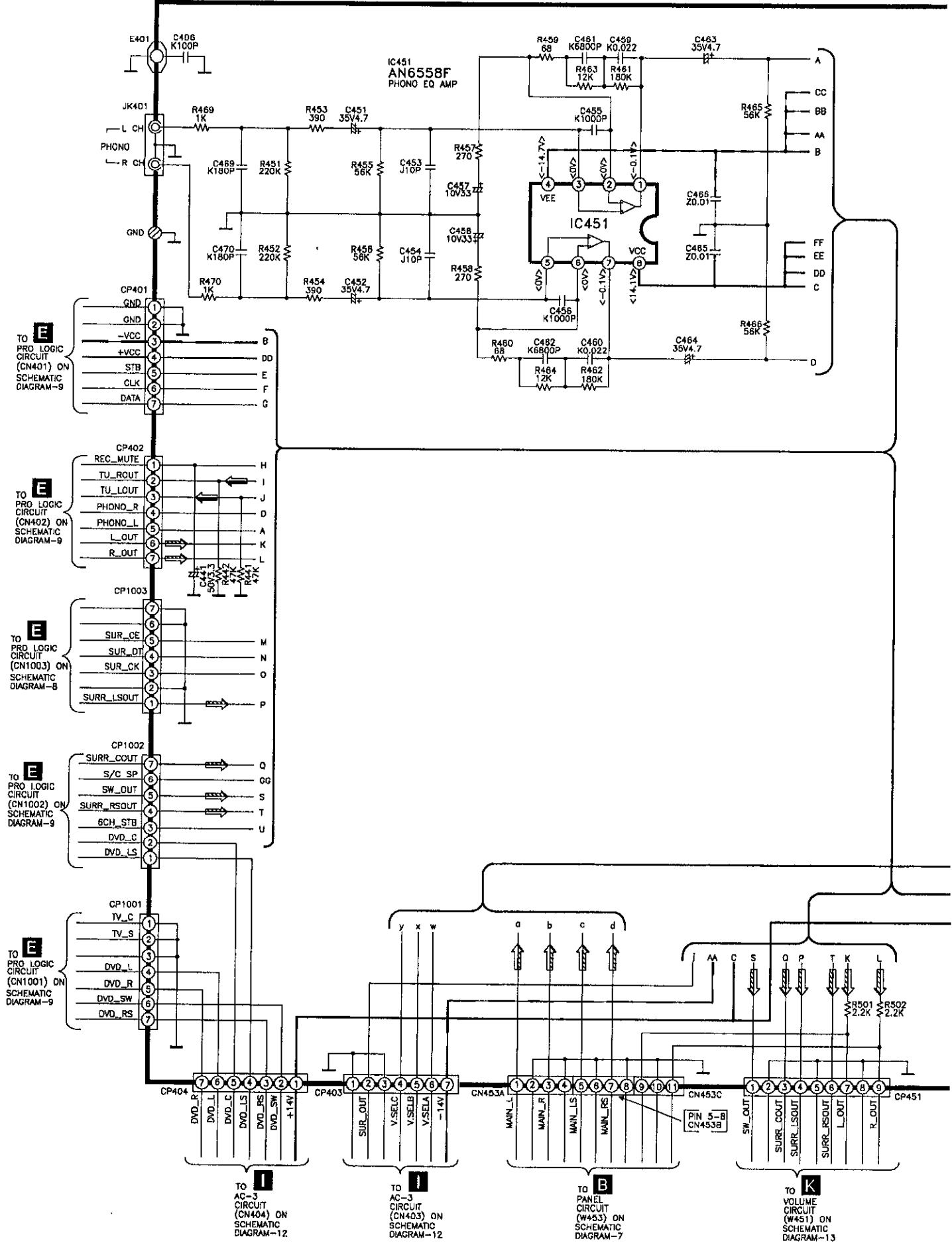

SCHEMATIC DIAGRAM-2

— : +B Line
 - - - : -B Line

⇨ : Main Signal Line
 ⇨ : FM/AM Signal Line

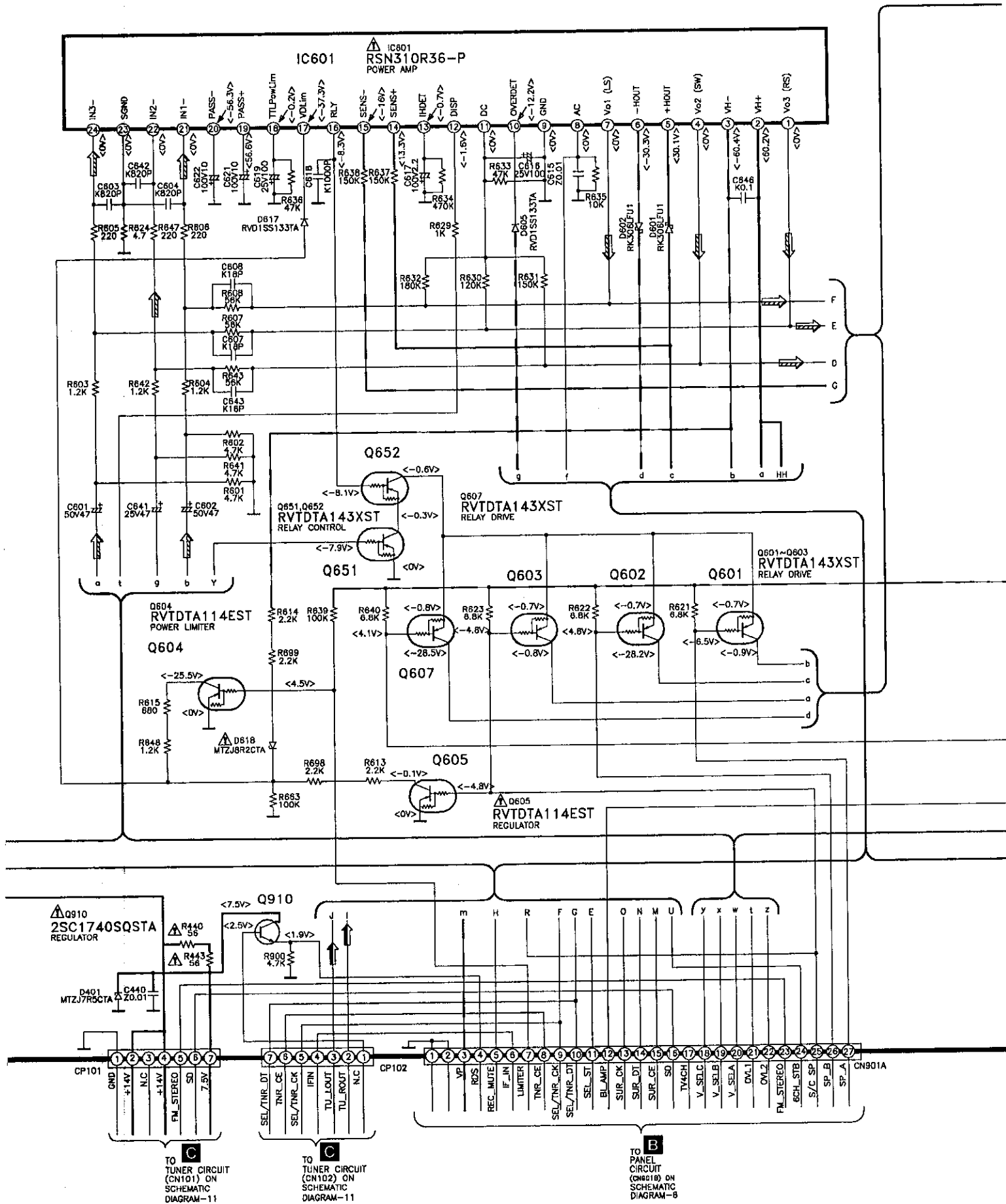

SCHEMATIC DIAGRAM-3

— : +B Line

- - - : -B Line

⇒ : Main Signal Line

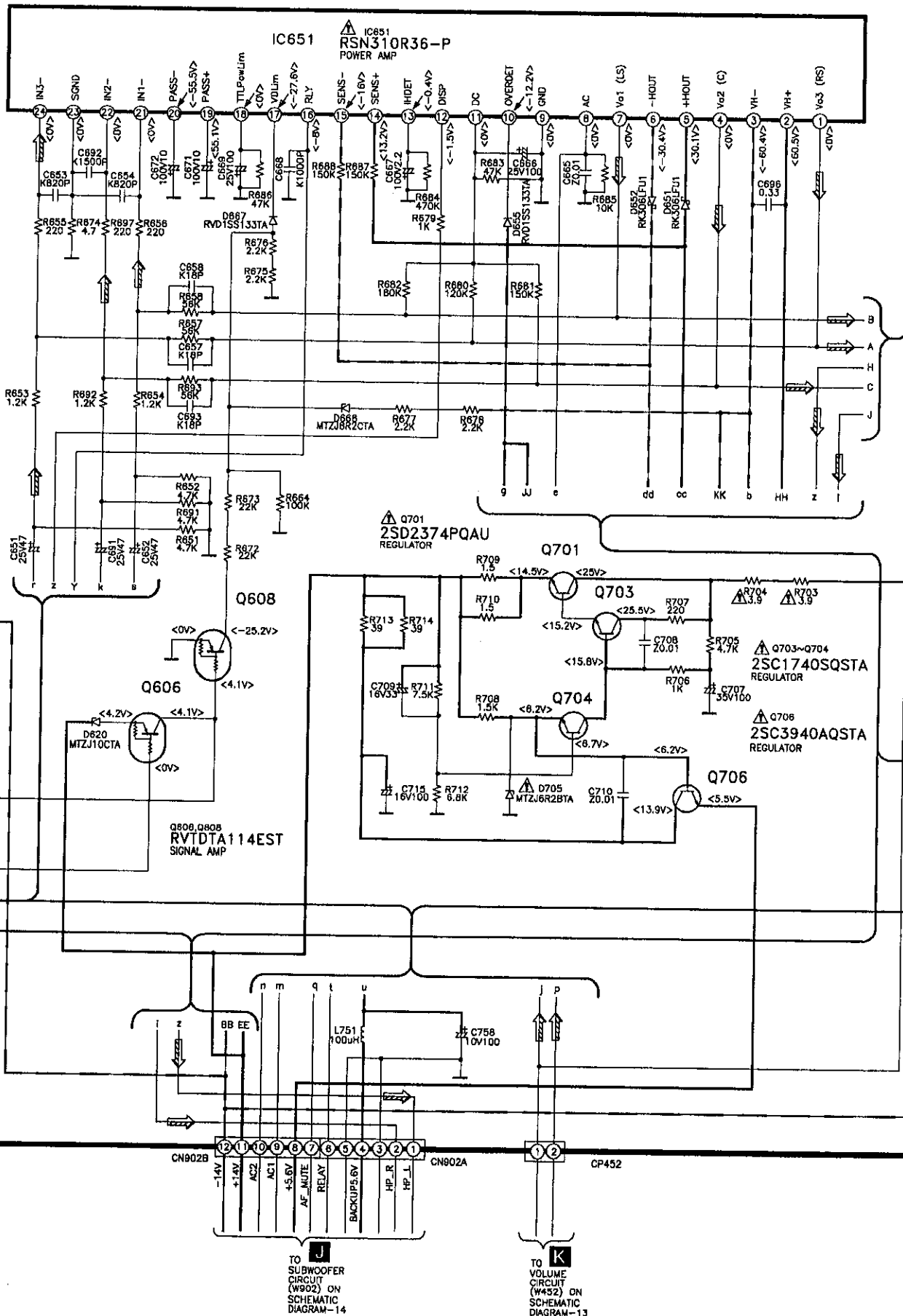

TO SUBWOOFER CIRCUIT (W902) ON SCHEMATIC DIAGRAM-14

TO VOLUME CIRCUIT (W452) ON SCHEMATIC DIAGRAM-13

SCHEMATIC DIAGRAM-4

— : +B Line - - - : -9 Line ⇒ : Main Signal Line

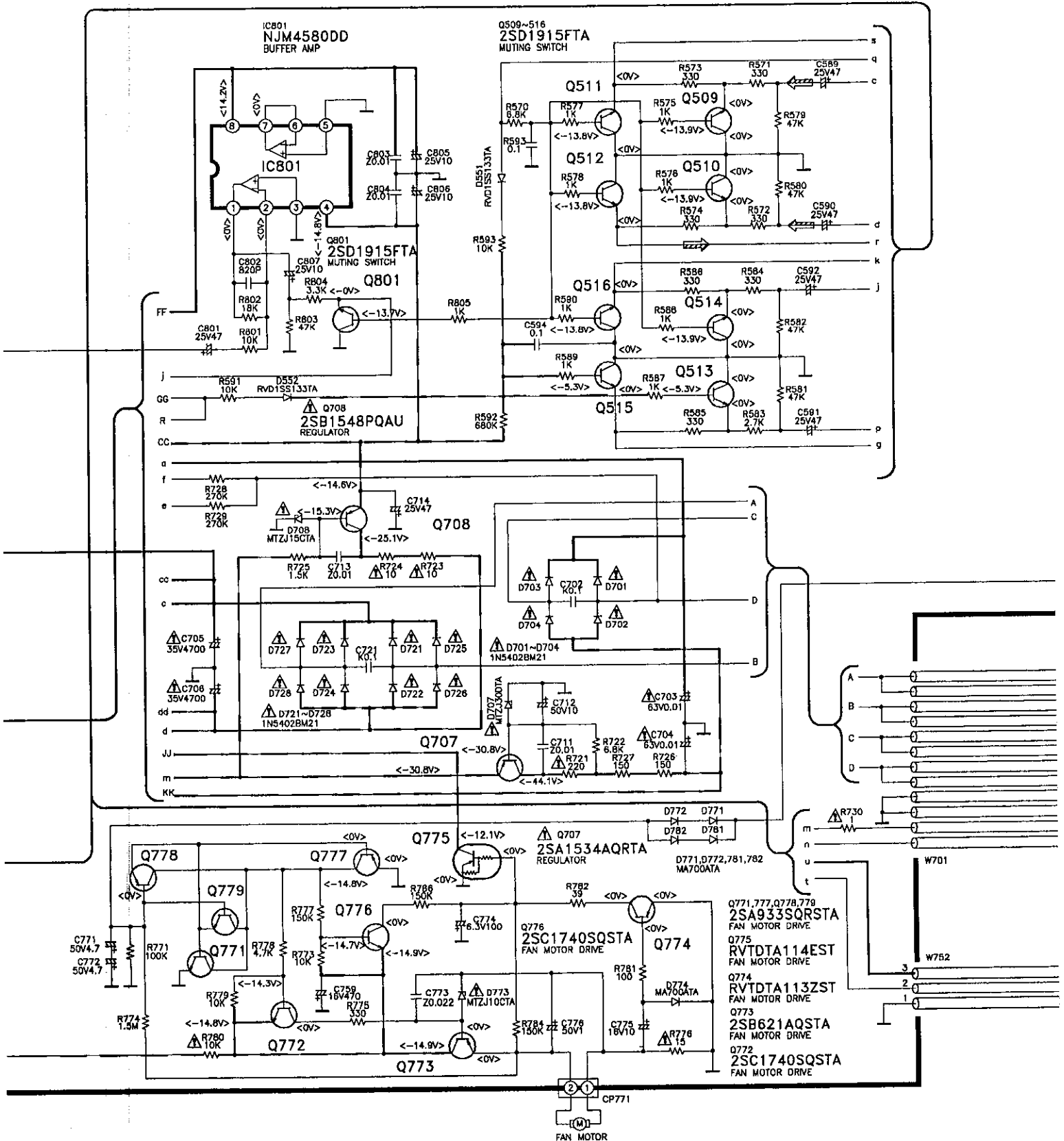

SCHEMATIC DIAGRAM-5

— : +B Line - - - : -B Line ⇨ : Main Signal Line

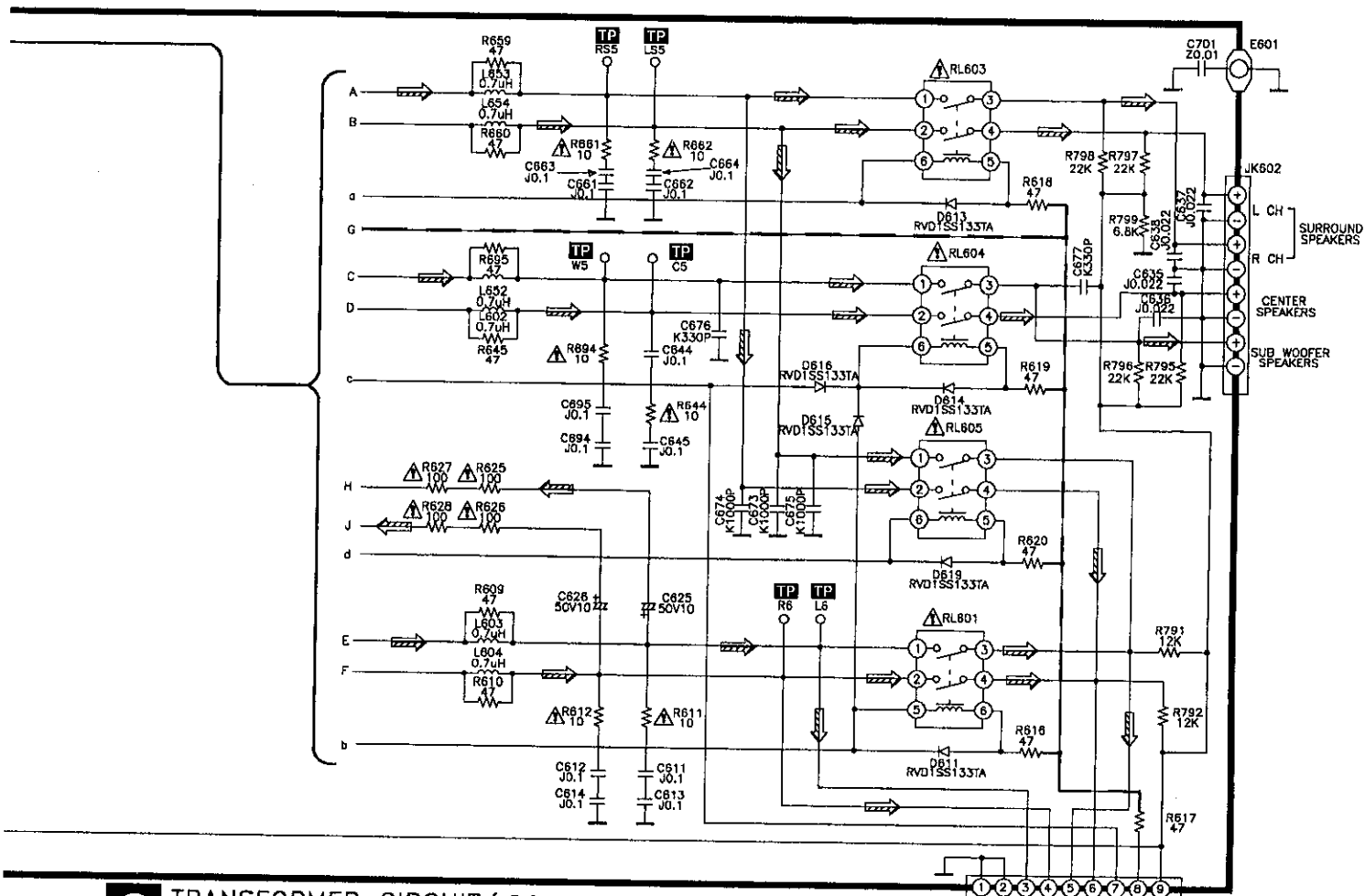

G TRANSFORMER CIRCUIT (P.C.Board on page 41)

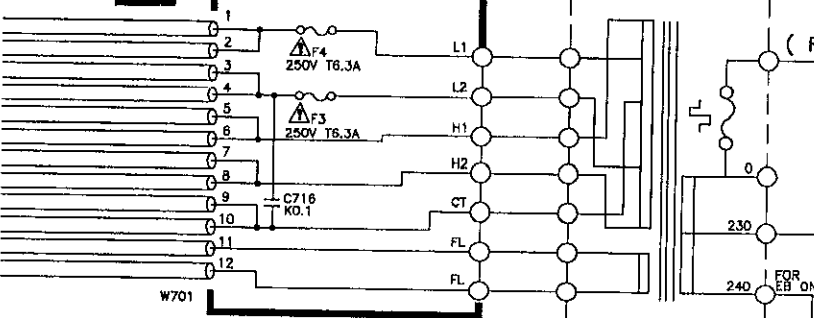

N FRONT SPEAKER CIRCUIT (P.C.Board on Page 43)

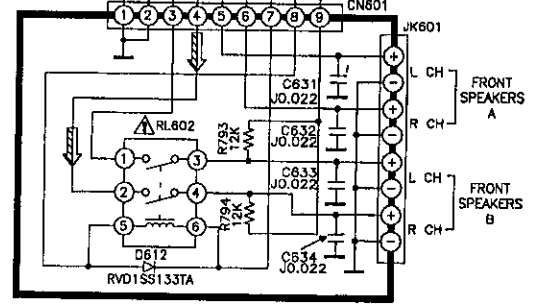

F POWER CIRCUIT (P.C.Board on page 41)

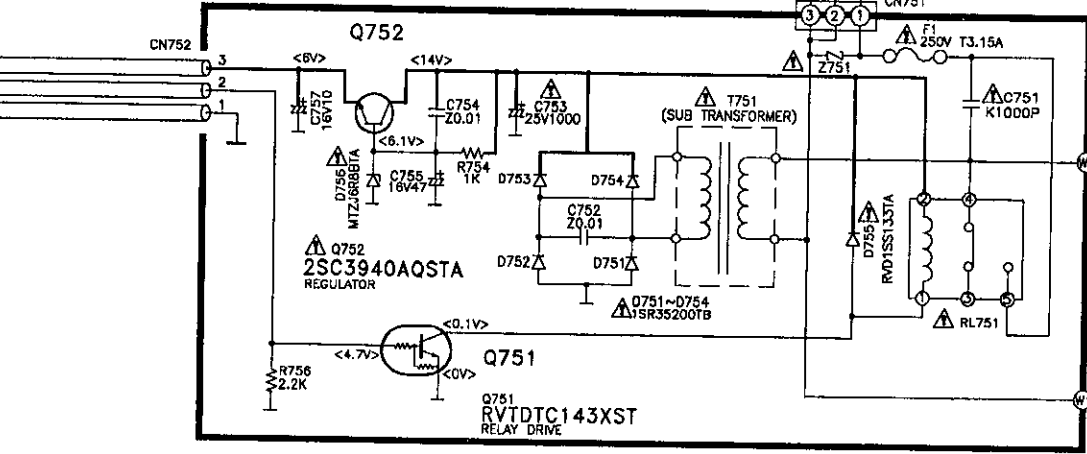

H AC IN/OUT CIRCUIT (P.C.Board on page 45)

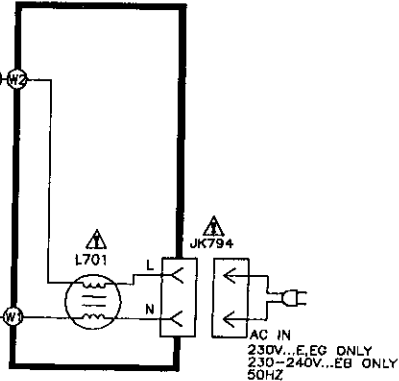

AC IN
230V...F,EG ONLY
230~240V...EB ONLY
50HZ

SCHEMATIC DIAGRAM-7

— : +B Line - - - : -B Line ⇨ : Main Signal Line

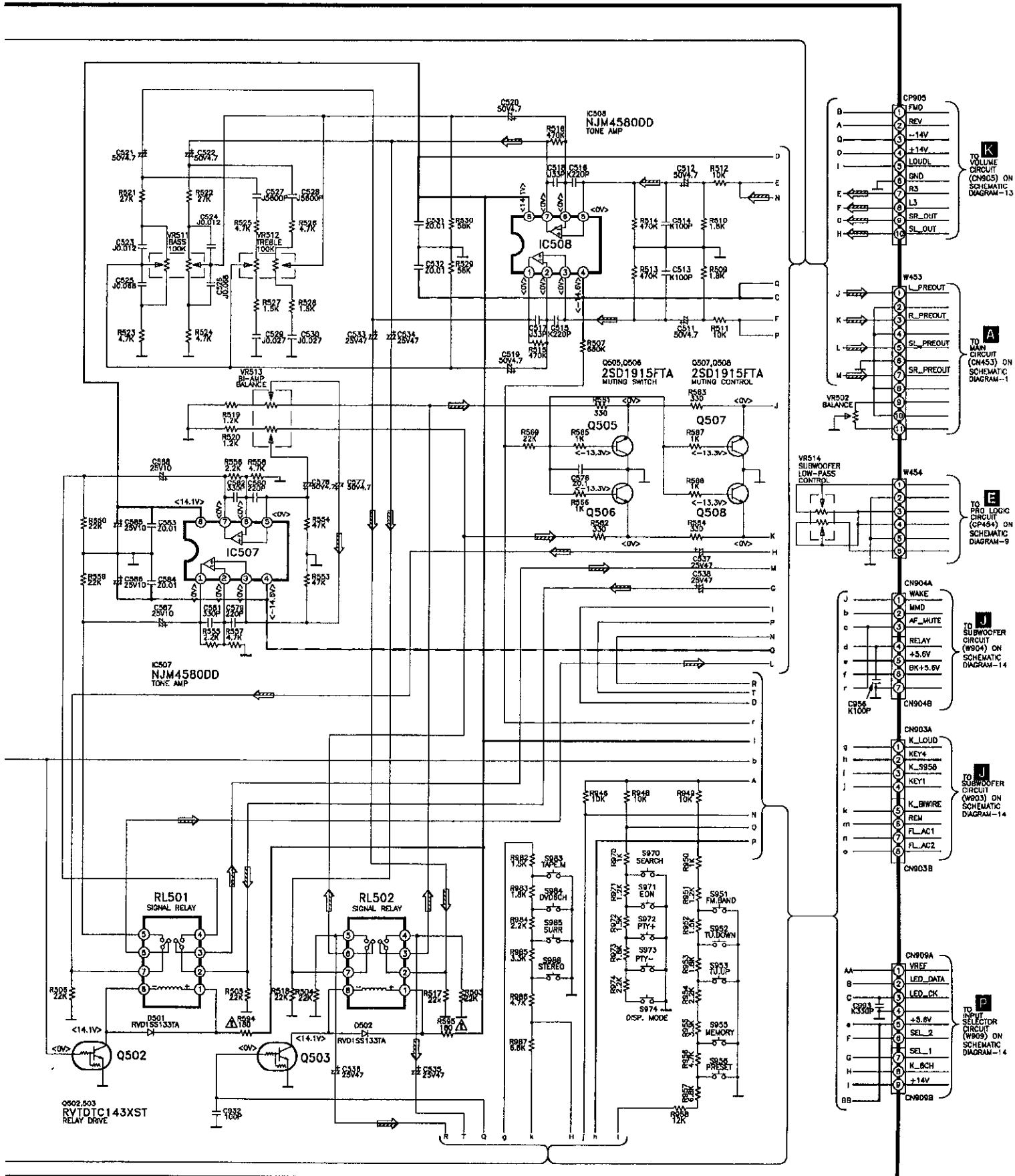

SCHEMATIC DIAGRAM-9

— : +B Line → : Main Signal Line
 - - - : -B Line

M VCR2 CIRCUIT
 (P.C.Board on page 42)

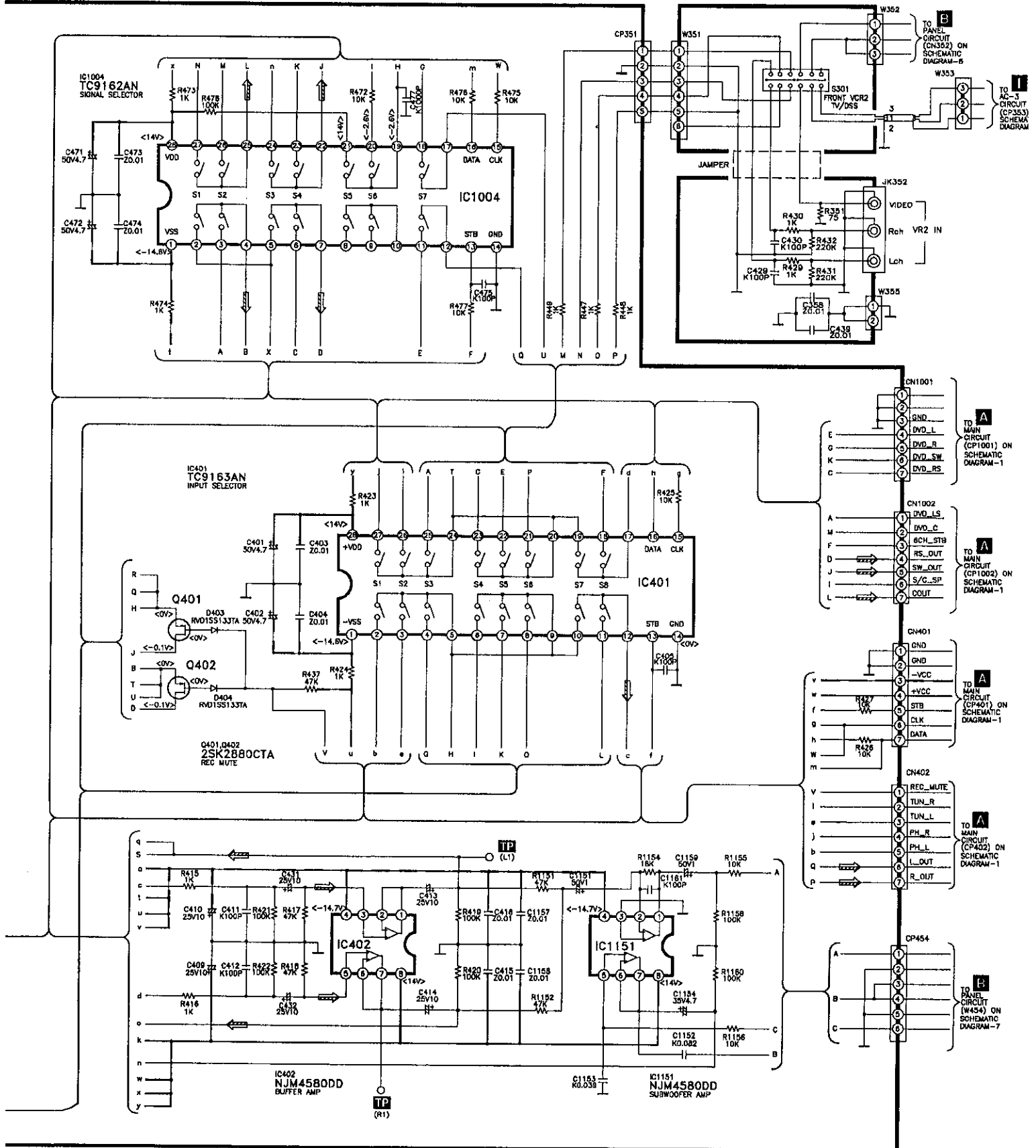

SCHEMATIC DIAGRAM-10



TUNER CIRCUIT

(P.C.Board on page 45)

- ↗ : FM Signal Line
- ↘ : FM OSC Signal Line
- : AM Signal Line
- ⇨ : AM OSC Signal Line
- : +B Line
- ⇨ : FM/AM Signal Line

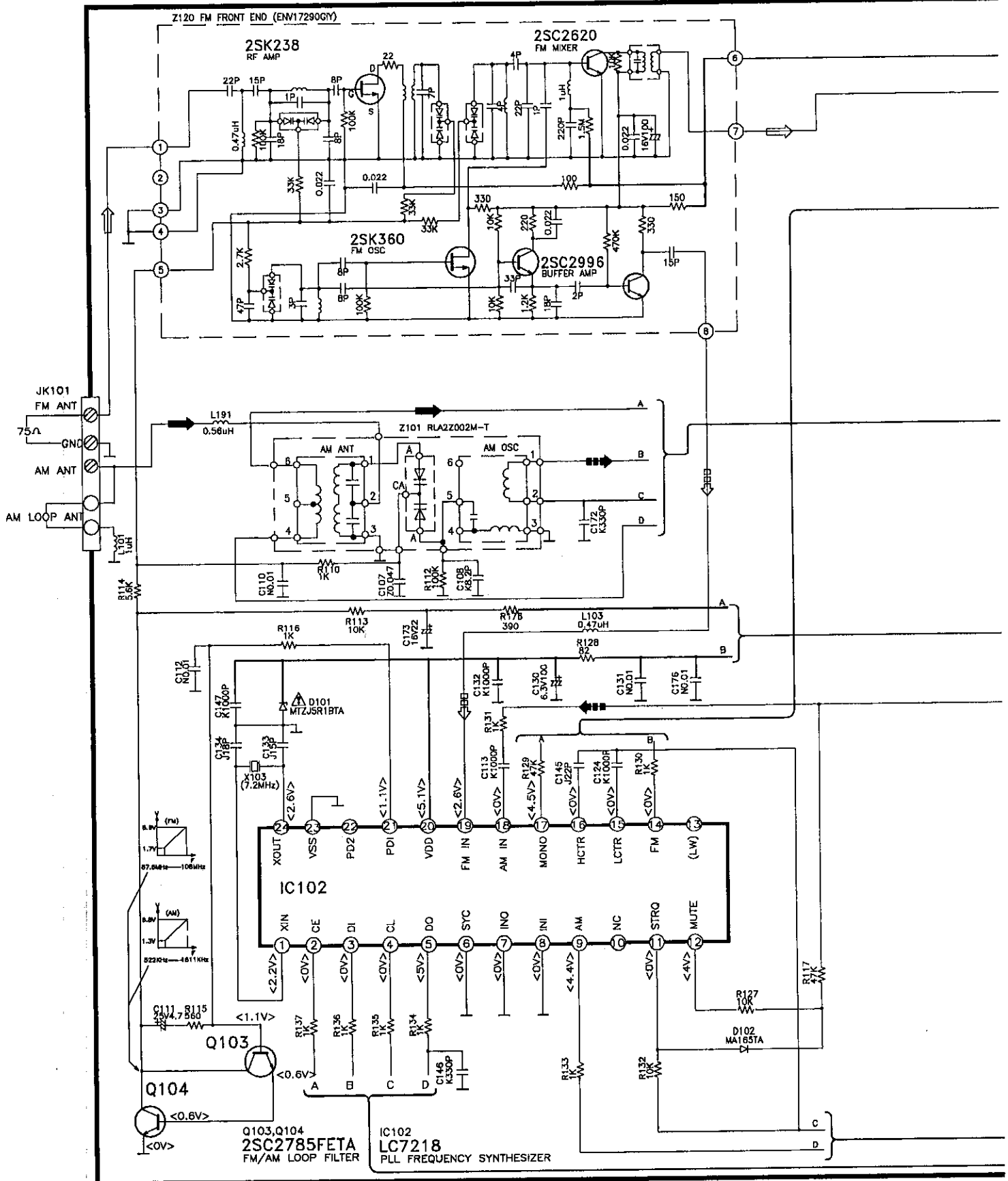

SCHEMATIC DIAGRAM-12

— : +B Line - - - : -B Line

AC-3 CIRCUIT (P.C.Board on page 43)

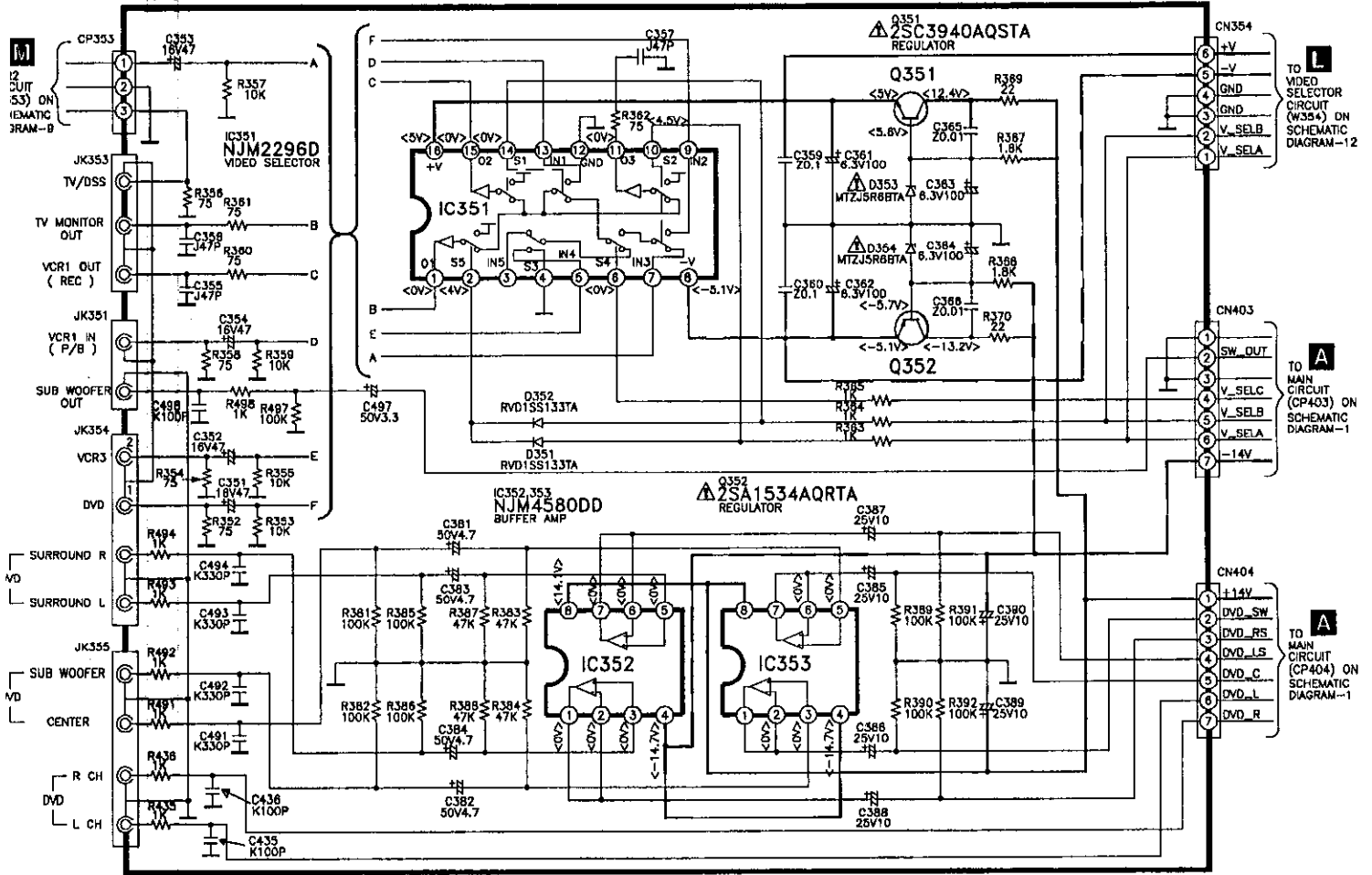

VIDEO SELECTOR CIRCUIT (P.C.Board on page 42)

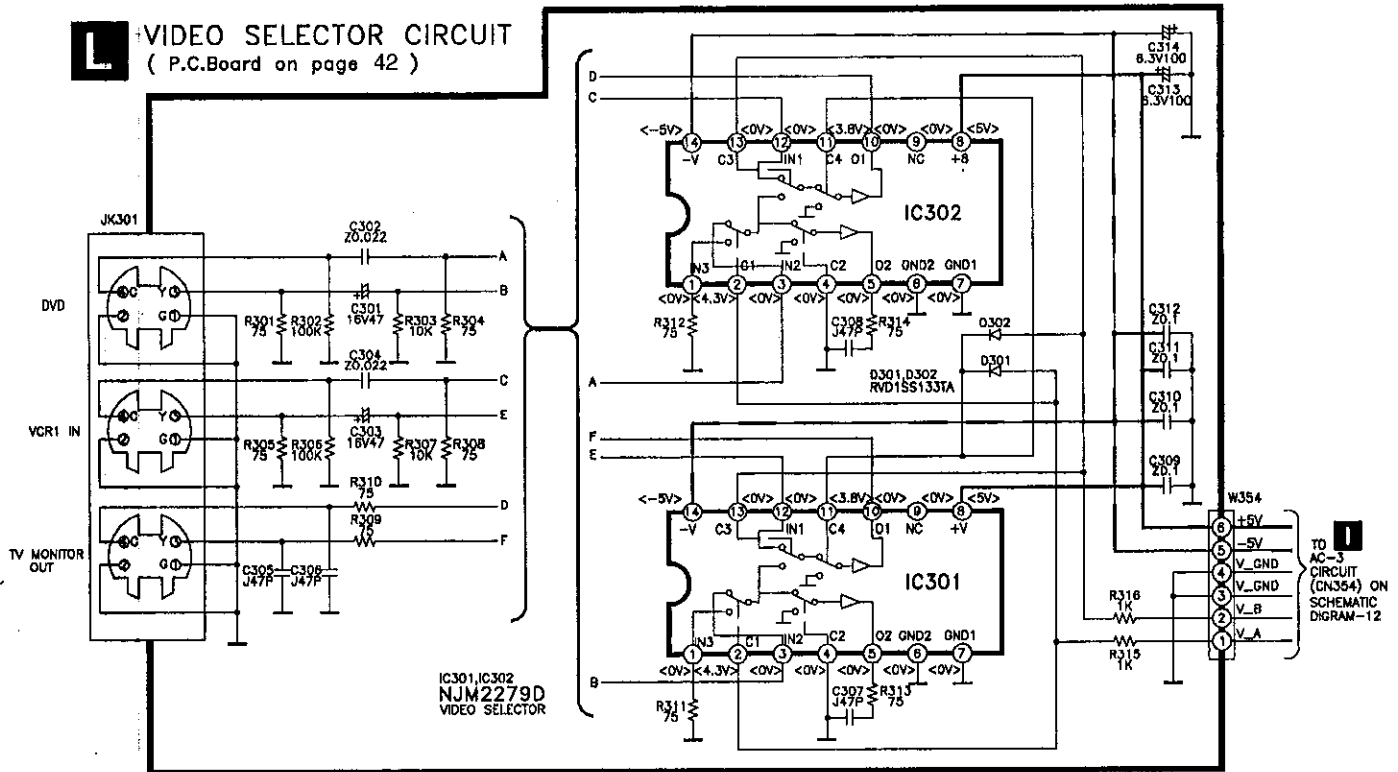

SCHEMATIC DIAGRAM-14

J SUBWOOFER CIRCUIT
(P.C.BOARD ON PAGE 38)

— : +B Line - - - : -B Line

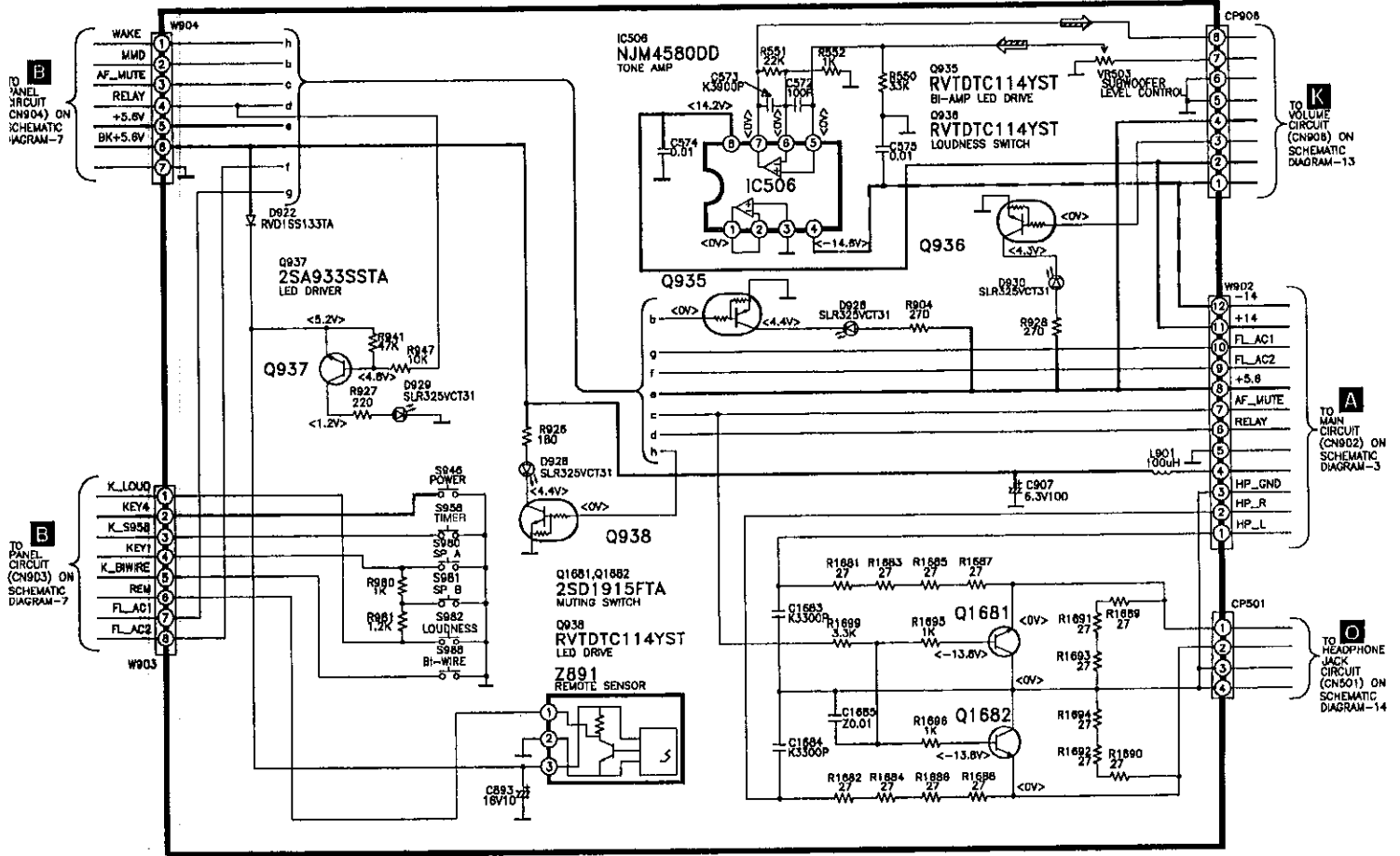

P INPUT SELECTOR CIRCUIT
(P.C.BOARD ON PAGE 44)

Q BLUE LED CIRCUIT (LEFT)
(P.C.Board on page 44)

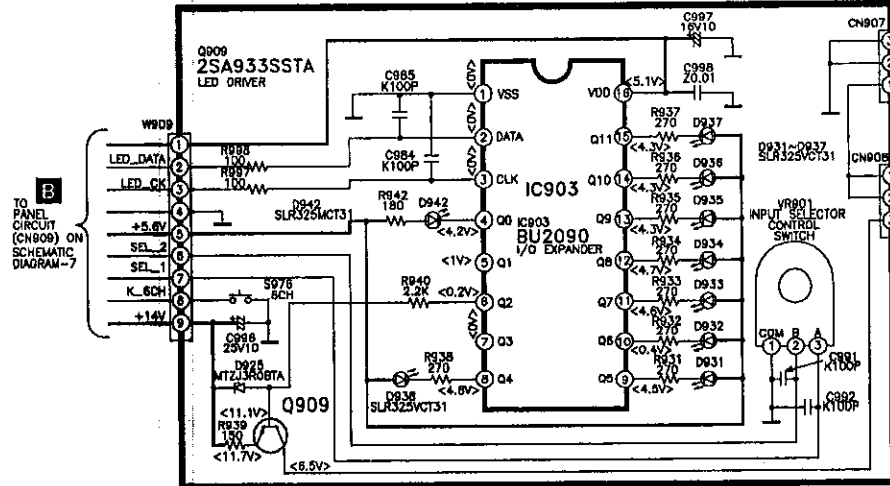

Q BLUE LED CIRCUIT (RIGHT)
(P.C.Board on page 44)

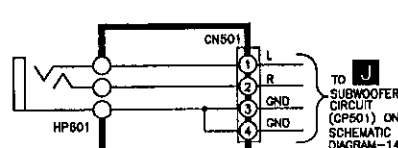

O HEADPHONE JACK CIRCUIT
(P.C.Board on page 44)

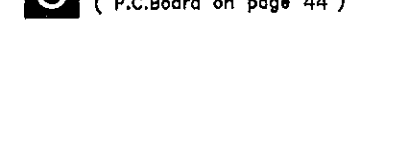

■ Printed Circuit Board

A B C D E F G T

A MAIN P.C.B. (REP2854B-M)

1
2
3
4
5
6
7
8
9
10

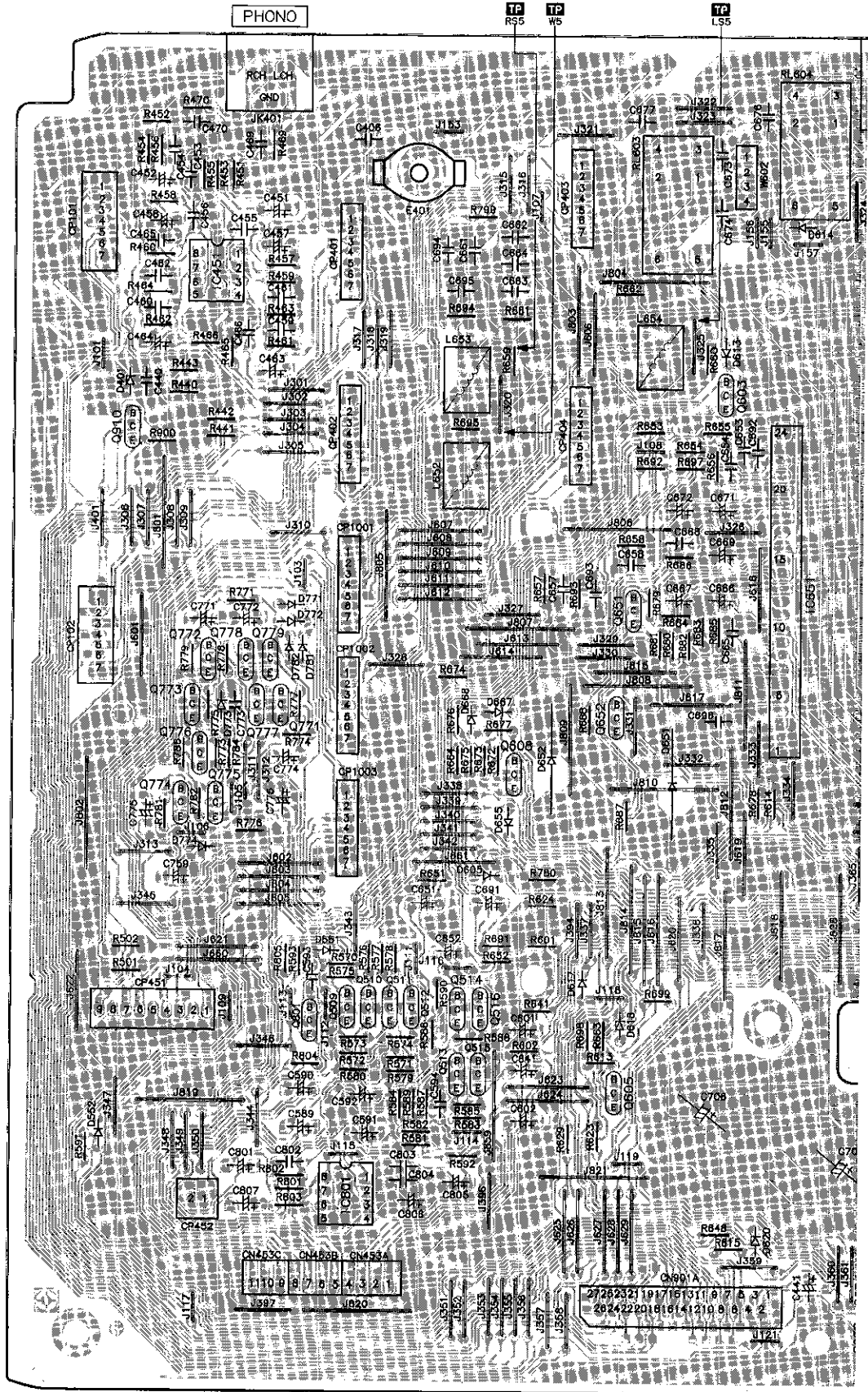

J K L M N O P

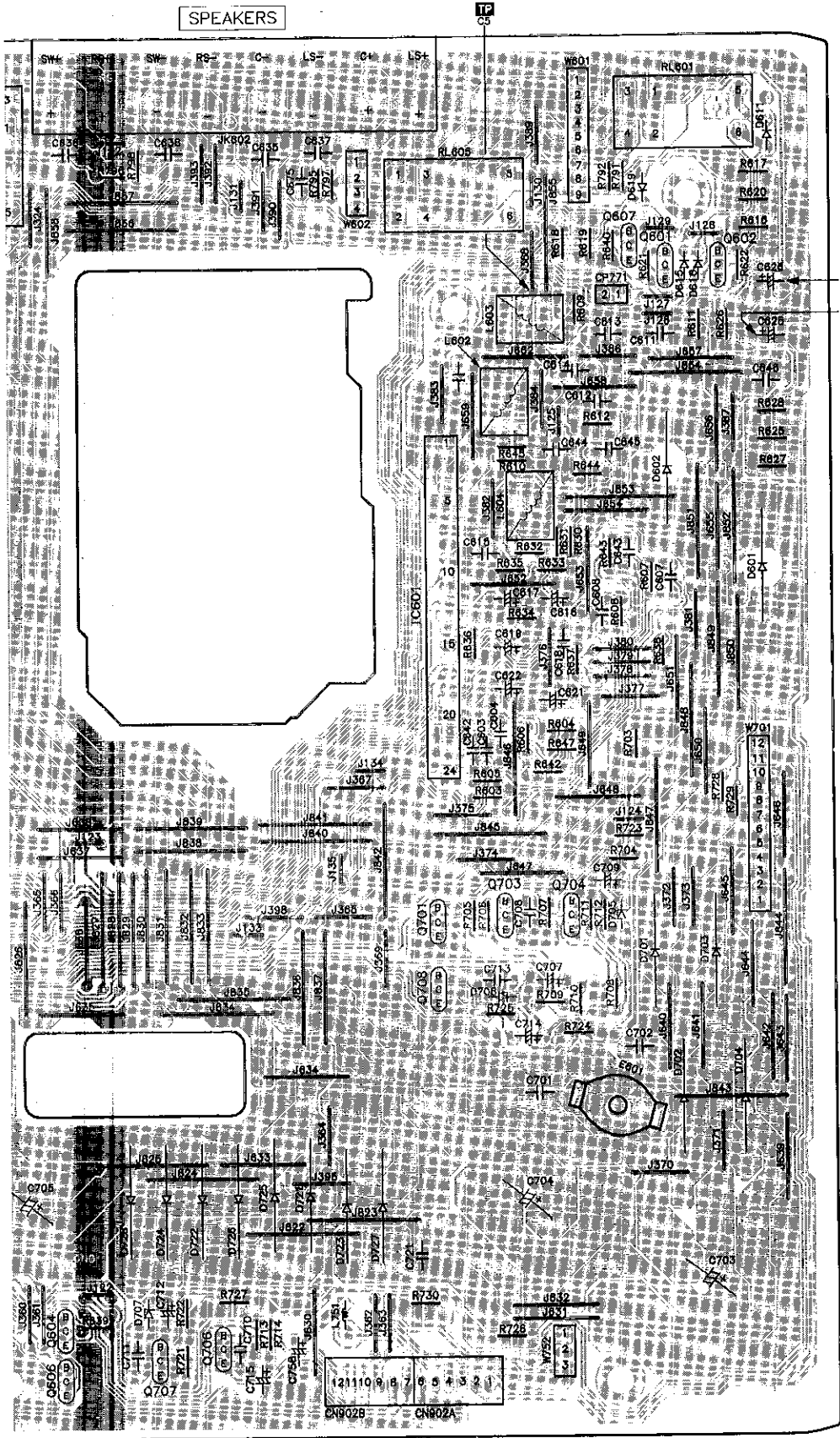

Parts Location Table

Ref No.	Loc. No.	Ref No.	Loc. No.
CN453A	D9	E401	E2
CN453B	D9	E601	M8
CN453C	D9	IC451	C3
CN901A	G10	IC601	L5
CN902A	L10	IC651	G5
CN902B	X10	IC801	D9
CP1001	D5	JK401	D2
CP1002	D6	JK602	K2
CP1003	D6	L602	L3
CP101	C2	L603	M3
CP102	C5	L604	M4
CP401	D3	L652	E4
CP402	D4	L653	E3
CP403	F2	L654	F3
CP404	F4	L751	K10
CP451	C7	Q509	D7
CP452	C9	Q510	D7
CP771	M3	Q511	E7
D401	C4	Q512	E7
D552	C8	Q513	E8
D601	N4	Q514	E7
D602	M4	Q516	E7
D605	E7	Q515	E8
D611	N2	Q601	N3
D613	G3	Q602	N9
D614	G2	Q603	G3
D615	N3	Q604	J10
D616	N3	Q605	F8
D617	F7	Q606	J10
D618	F8	Q607	M3
D619	M2	Q608	E6
D620	G9	Q651	F5
D651	G6	Q652	F6
D652	F6	Q701	L7
D655	E6	Q703	L7
D667	E6	Q704	M7
D668	E6	Q705	M7
D701	M7	Q706	K10
D702	N8	Q707	J10
D703	N7	Q708	L7
D704	N8	Q772	C5
D705	M7	Q773	C6
D707	J10	Q774	C6
D708	L7	Q775	C6
D721	K9	Q776	C6
D722	J9	Q777	D6
D723	K9	Q778	D5
D724	J9	Q910	C4
D725	K9	RL601	M2
D726	K9	RL603	F2
D727	L9	RL604	G2
D728	J9	RL605	L2
D771	D5	W601	M2
D772	D5	W602	G2
D773	C6	W701	N6
D774	C7	W752	M10

A B C D E F G

B PANEL P.C.B. (REP2855B-S)

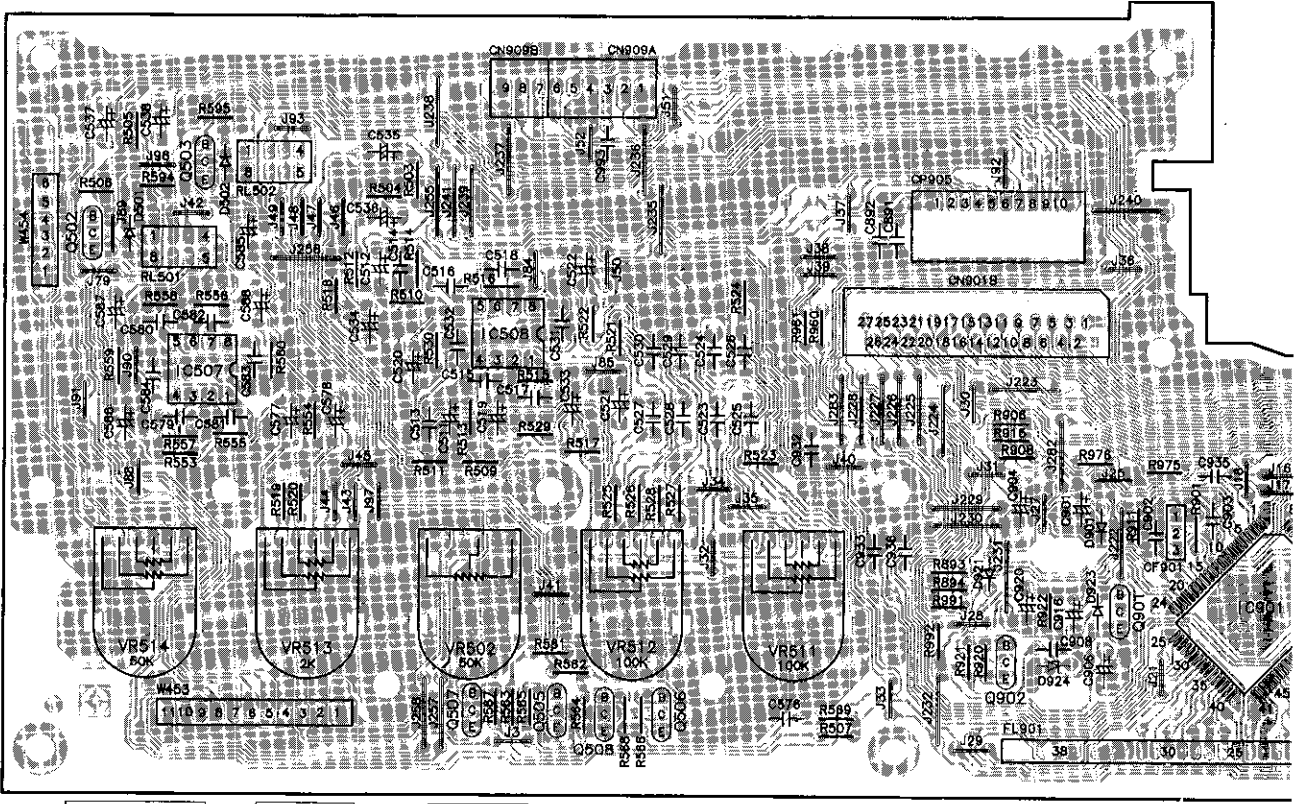

SUB-WOOFER LOW-PASS FILTER BI-AMP BALANCE BALANCE TREBLE BASS

J SUBWOOFER P.C.B. (REP2855B-S)

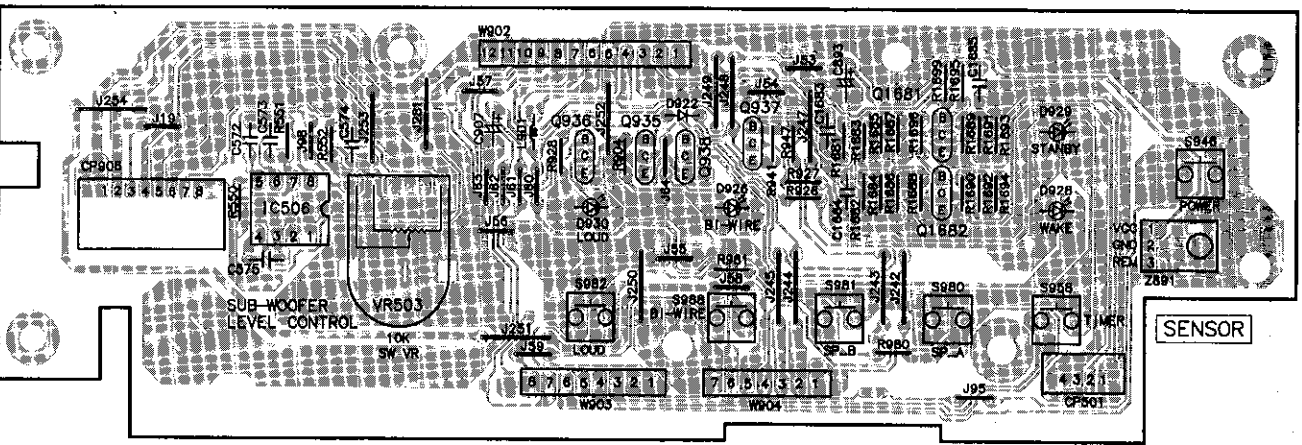

SUB-WOOFER LEVEL CONTROL SW VR BI-WIRE BI-WIRE STANDBY WAKE TIMER SENSOR

1
2
3
4
5
6
7
8
9
10

G H I J K L N

Parts Location Table

Ref. No.	Loc. No.
CF901	G4
CN352	L3
CN901B	E3
CN903A	K3
CN903B	K3
CN904A	L3
CN904B	L3
CN909A	D2
CN909B	D2
CP905	F2
D901	G4
D903	I3
D911	H5
D921	F4
D923	F4
D924	F4
D927	I3
FL901	F5
IC507	B3
IC508	C3
IC901	G4
IC902	J3
Q505	D5
Q506	D5
Q507	B5
Q508	D5
Q901	G4
Q902	F5
S951	J4
S952	J5
S953	I5
S955	I4
S956	J4
S970	J5
S971	K5
S972	K5
S973	K5
S974	L5
S983	L4
S984	K4
S985	K4
S986	K4
VR502	C4
VR511	E4
VR512	D4
VR514	A4
W453	B5
W454	A2
X901	J3
L902	J3
L903	I3

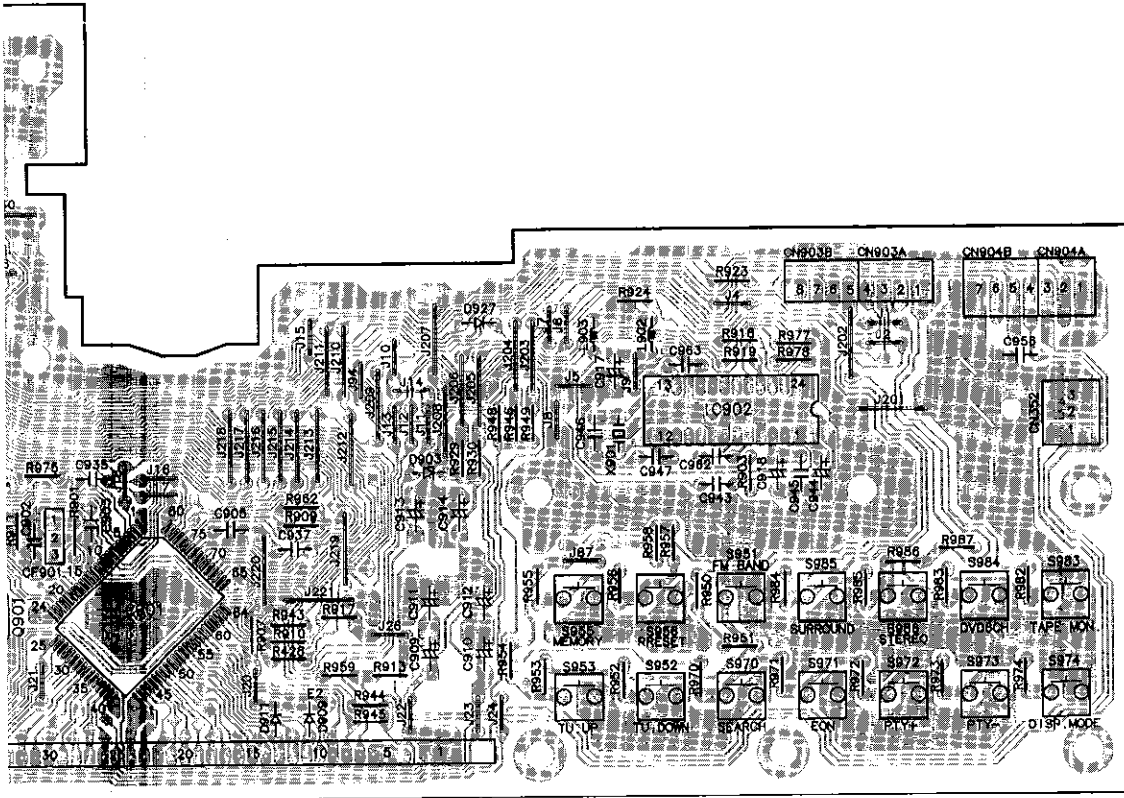

**☐ VOLUME P.C.B. (REP2856B-P) ... E/EG
(REP2856C-P) ... EB**

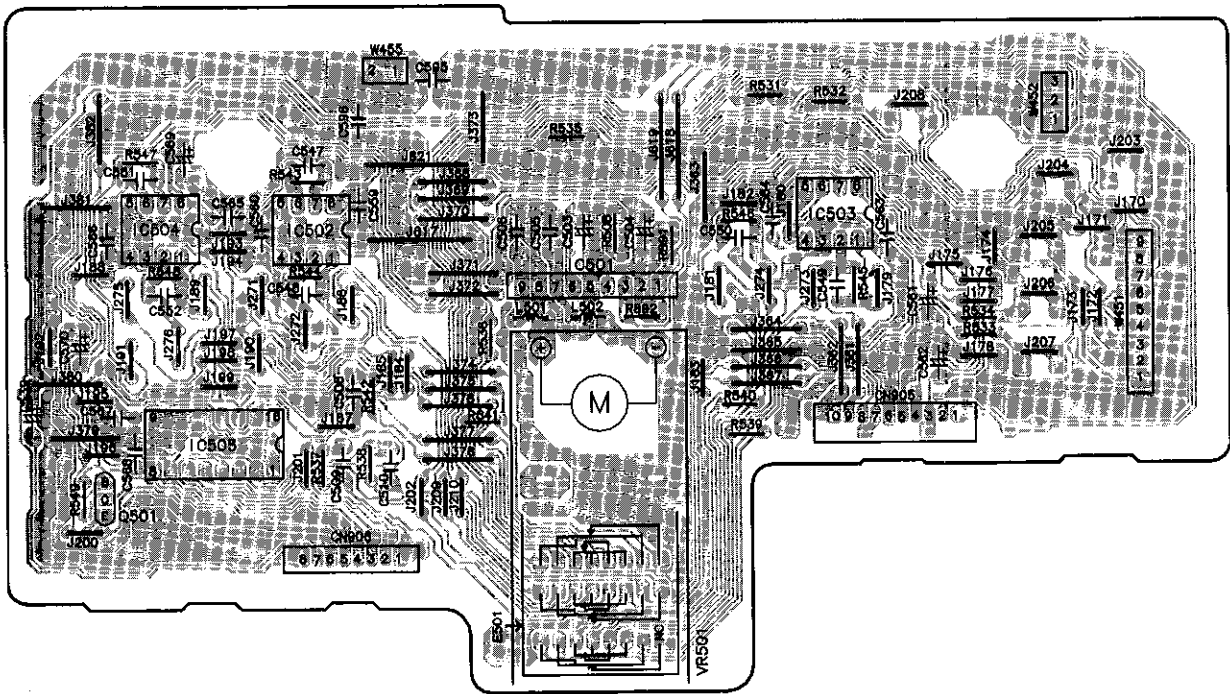

VOLUME

A B C D E F G

E PRO LOGIC P.C.B. (REP2856B-P) ... E/EG
(REP2856C-P) ... EB

1
2
3
4
5
6
7
8
9
10

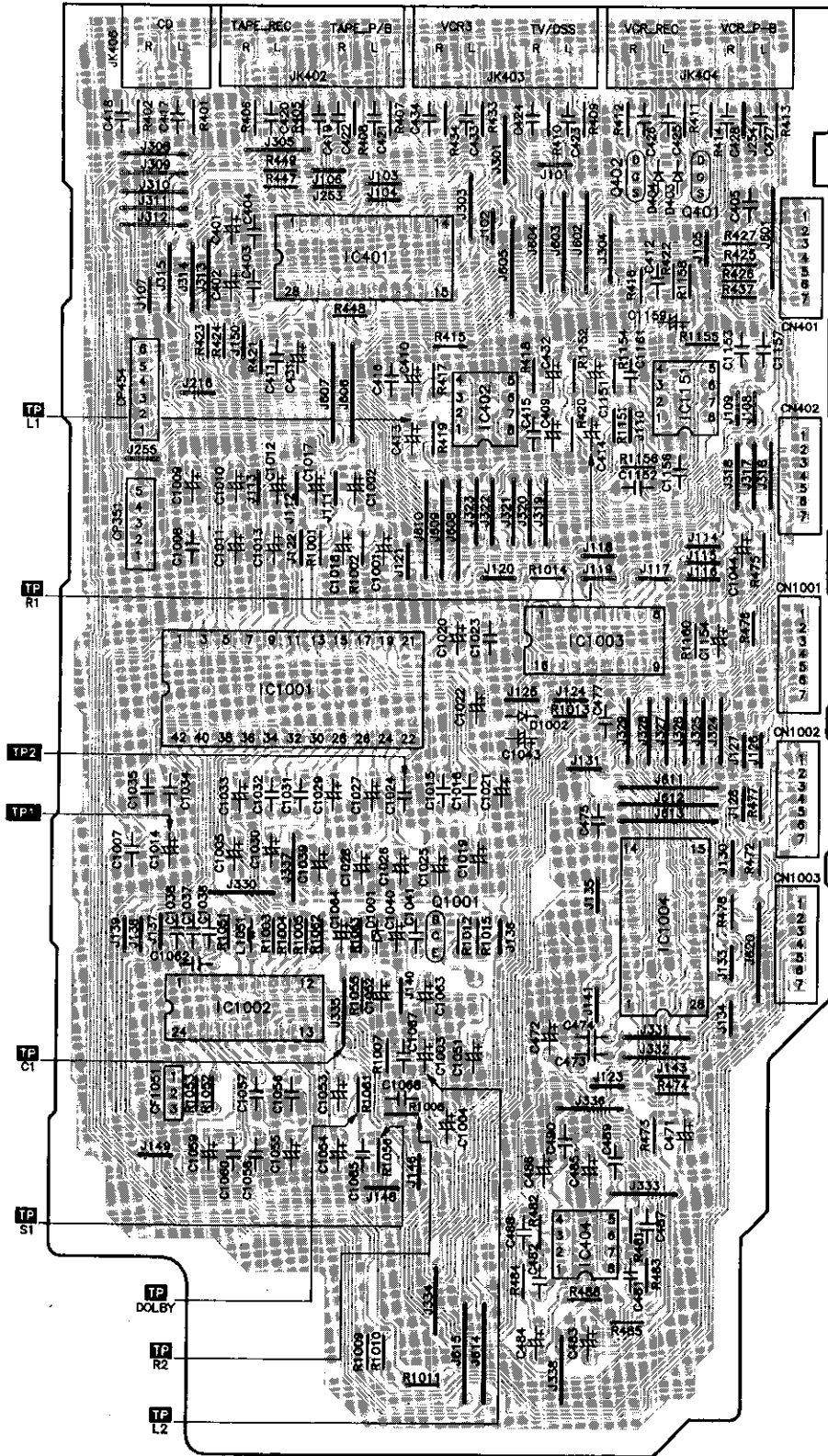

Parts Location Table

Ref No.	Loc. No.
CF1051	B8
CN1001	F6
CN1002	F6
CN1003	F7
CN401	F3
CN402	F4
CP351	B5
CP454	B4
D403	E3
D404	E3
D1001	C7
D1002	D6
IC1001	B6
IC1002	B7
IC1003	D6
IC1004	E7
IC1151	E4
IC401	C3
IC402	D4
IC404	D9
JK402	C2
JK403	D2
JK404	E2
JK406	B2
L1051	B7
Q1001	D7
Q401	E3
Q402	E3

G TRANSFORMER P.C.B. (REP2854B-M)

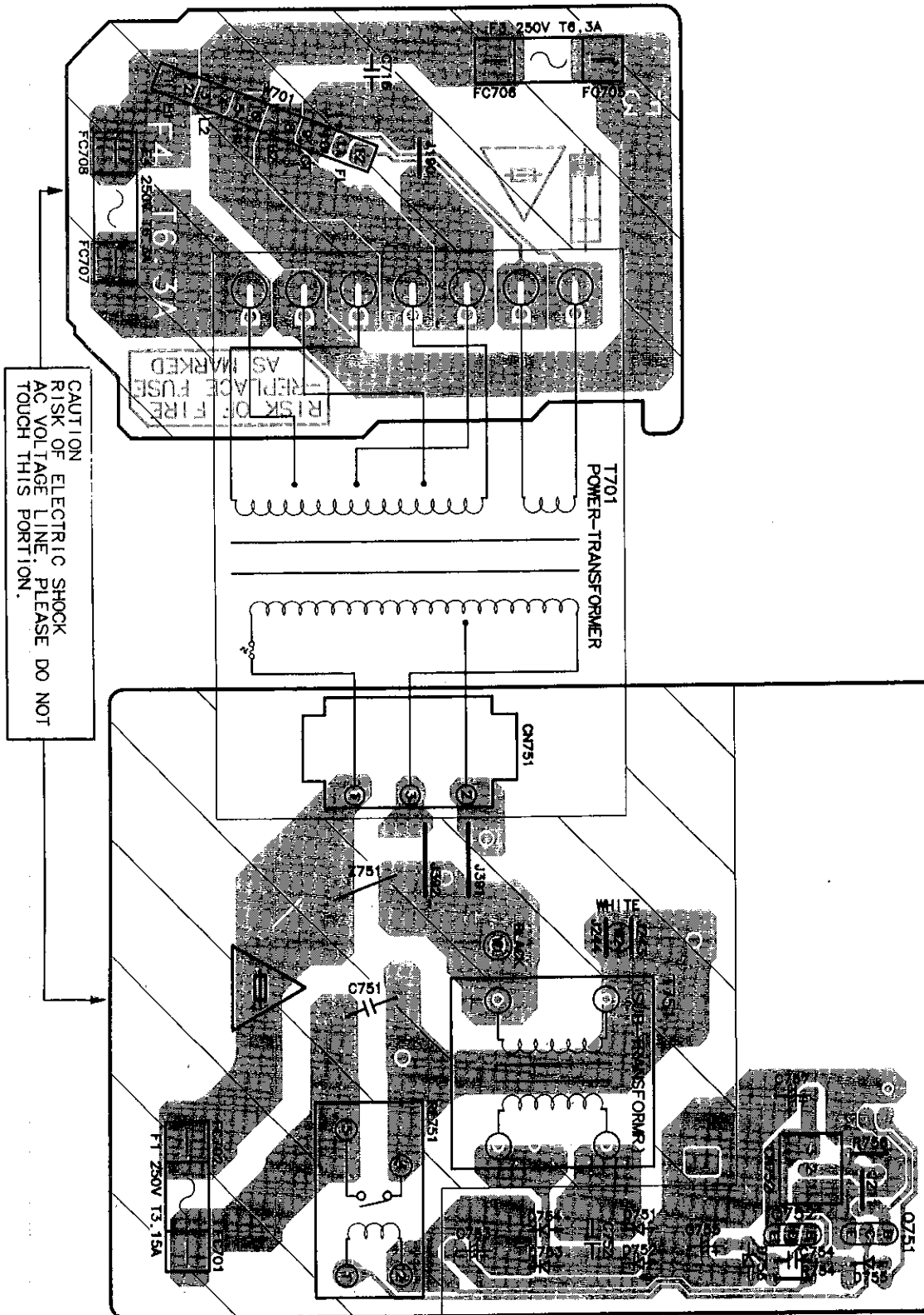

F POWER P.C.B. (REP2856B-P) ... E/EG
 (REP2856C-P) ... EB

L VIDEO SELECTOR P.C.B. (REP2855B-S)

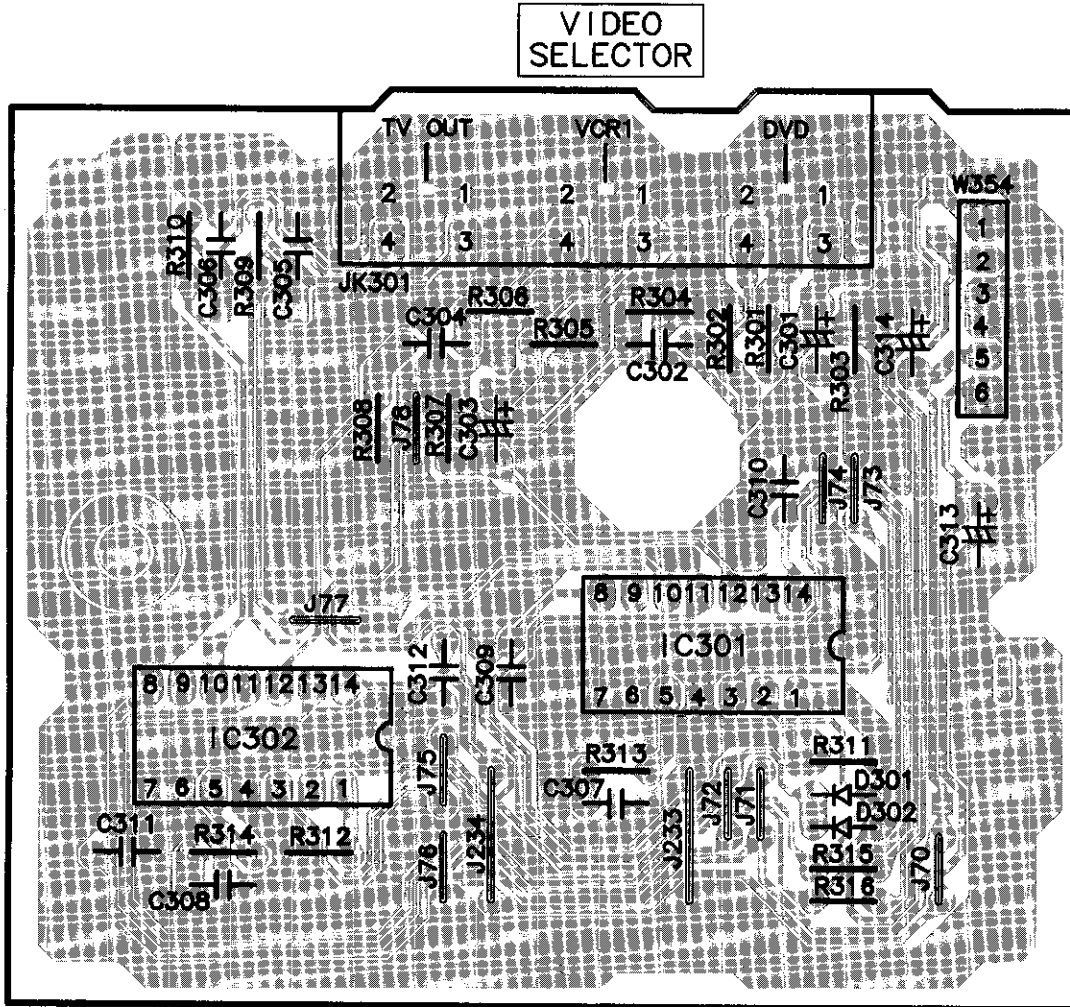

M VCR2 P.C.B. (REP2855B-S)

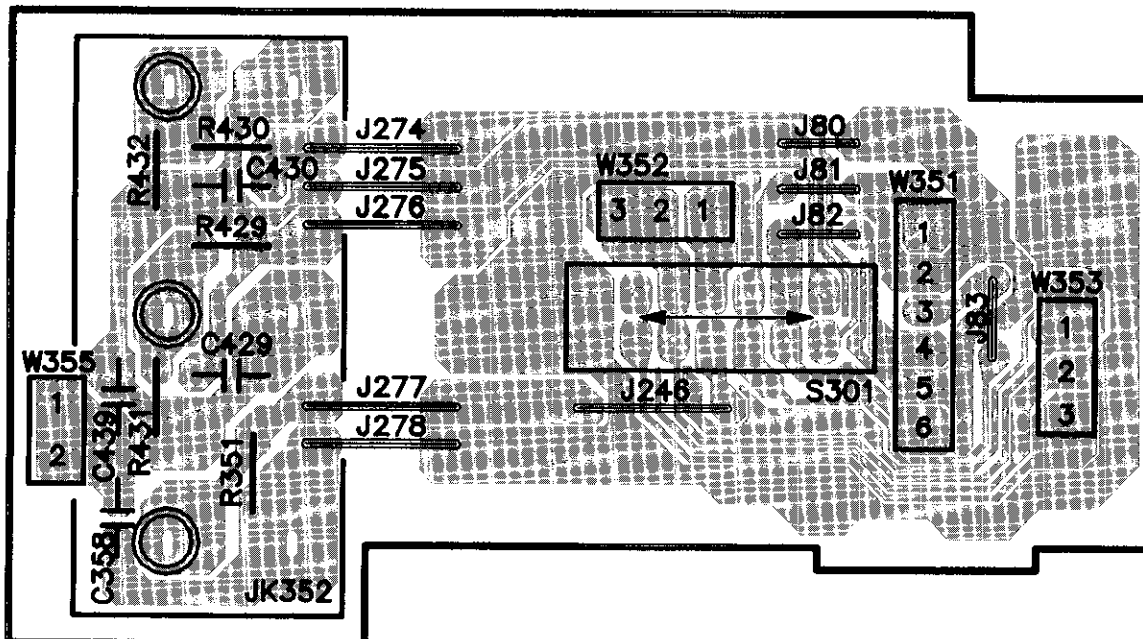

N FRONT SPEAKER P.C.B. (REP2856B-P) ... E/EG
(REP2856C-P) ... EB

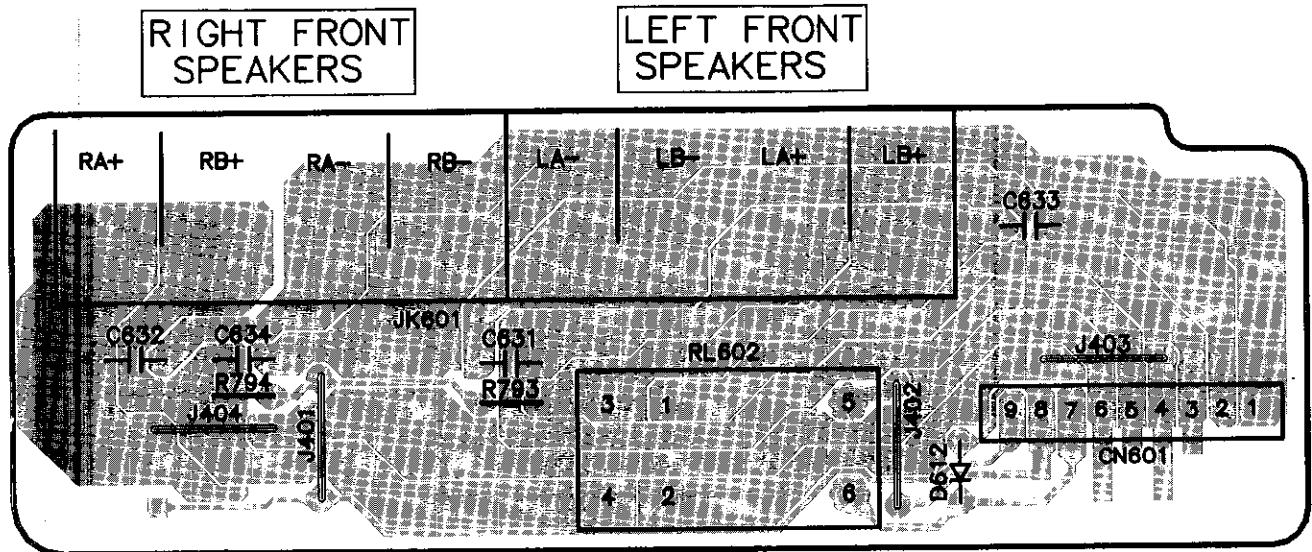

I AC-3 P.C.B. (REP2856B-P) ... E/EG
(REP2856C-P) ... EB

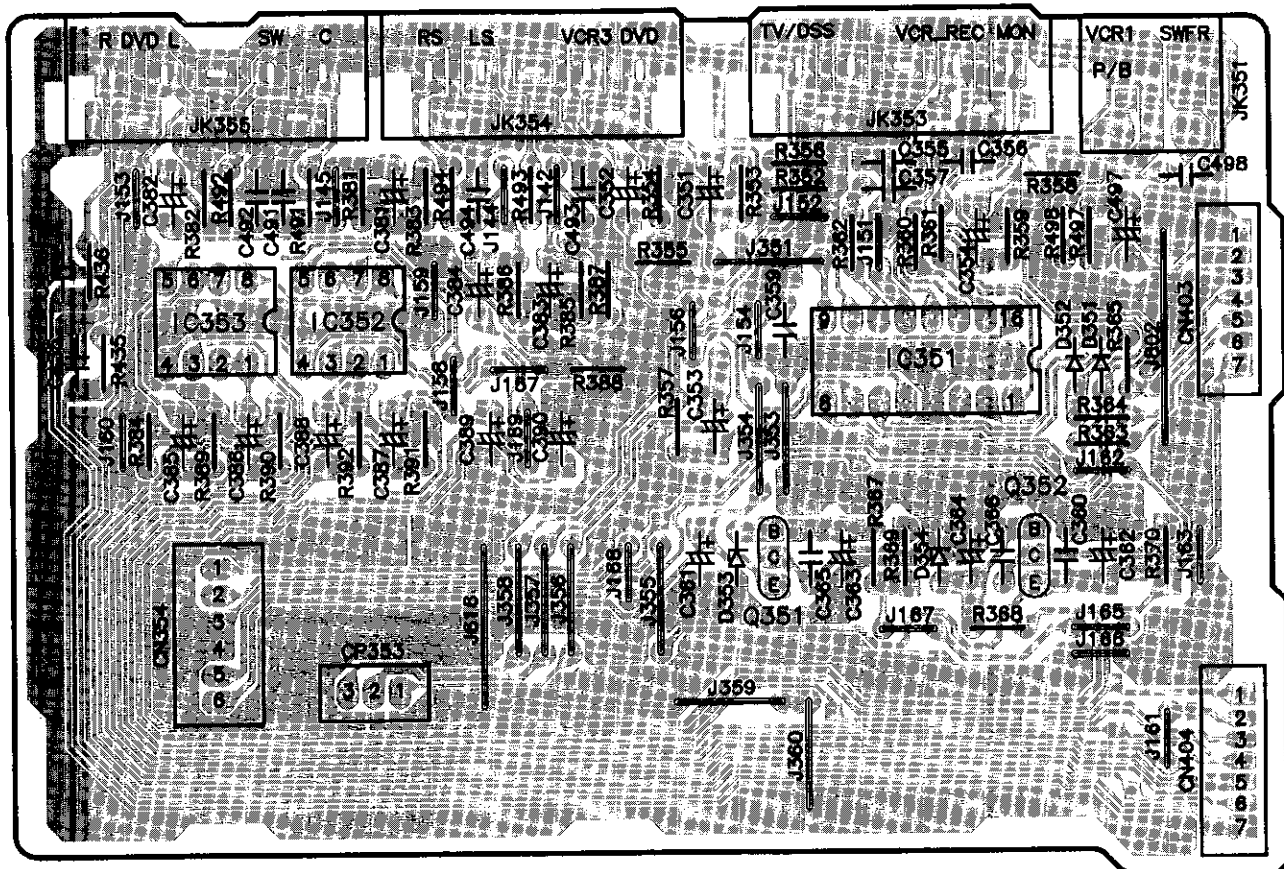

P INPUT SELECTOR P.C.B. (REP2855B-S)

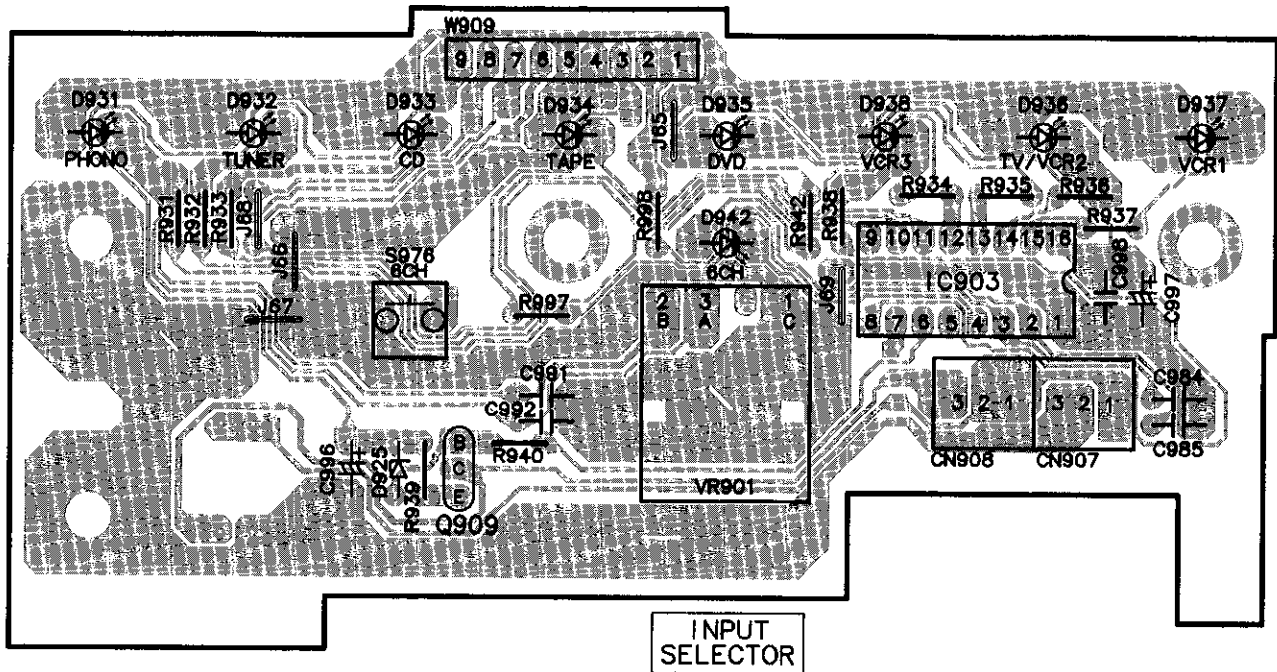

Q BLUE LED P.C.B. (REP2709A-S)

O HEADPHONE JACK P.C.B. (REP2855B-S)

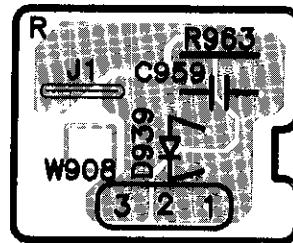
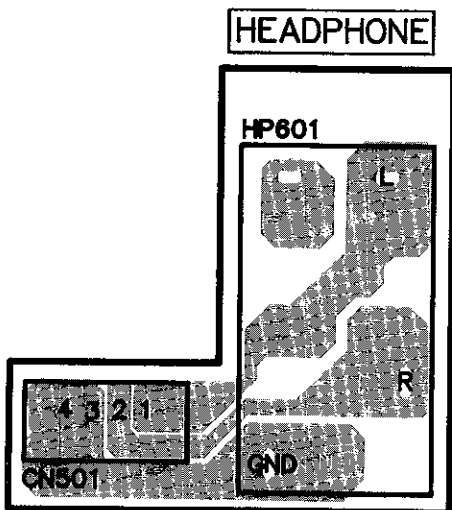

(RIGHT)

(LEFT)

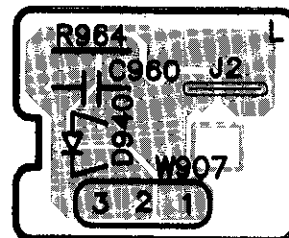

C TUNER P.C.B. (REP2254C-T)

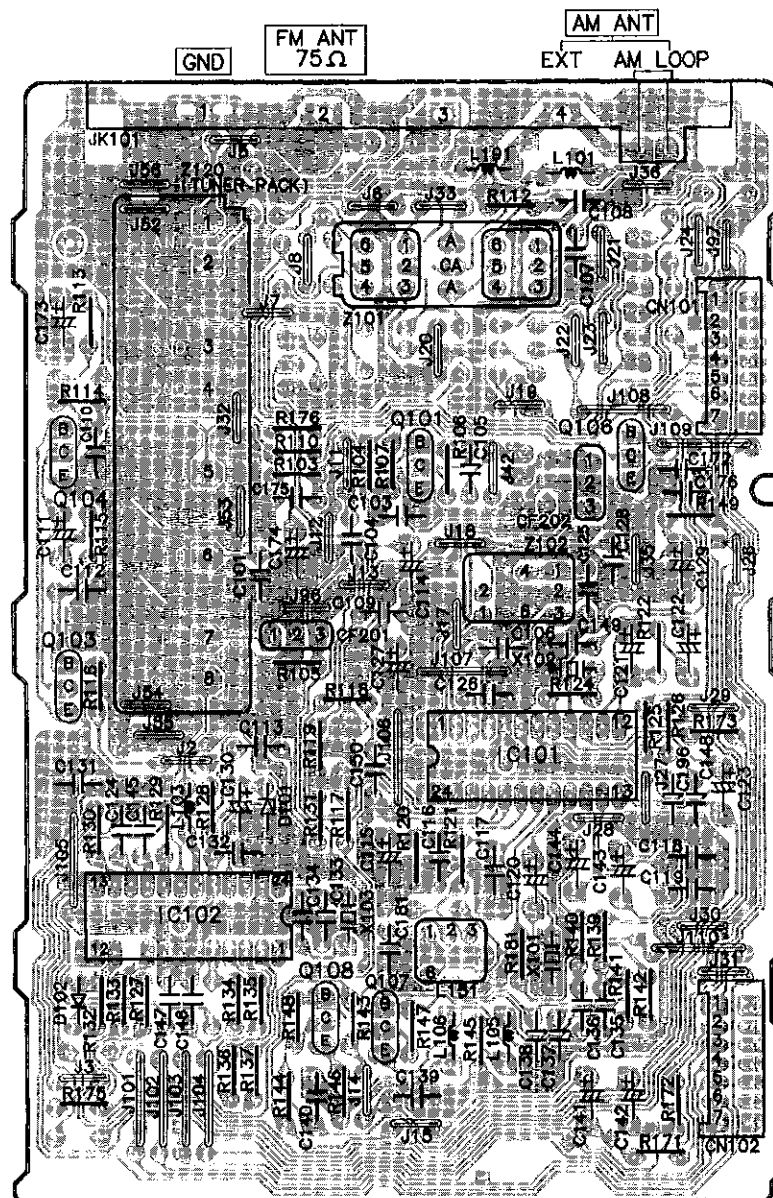

H AC IN/OUT P.C.B.
 (REP2856B-P) ... E/EG
 (REP2856C-P) ... EB

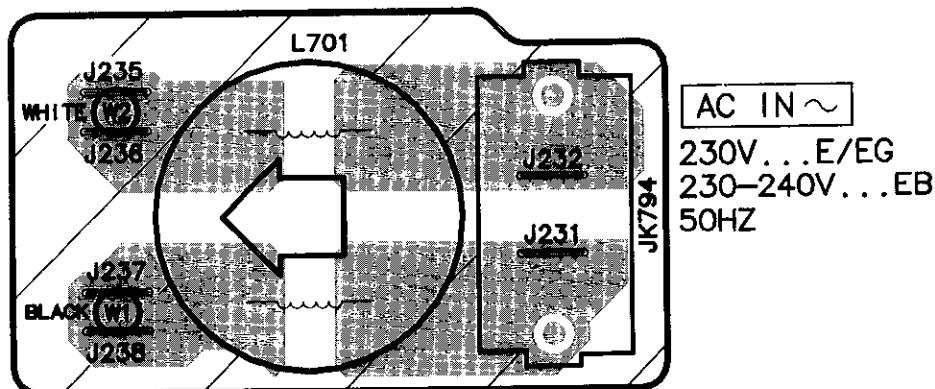

Wiring Connection Diagram

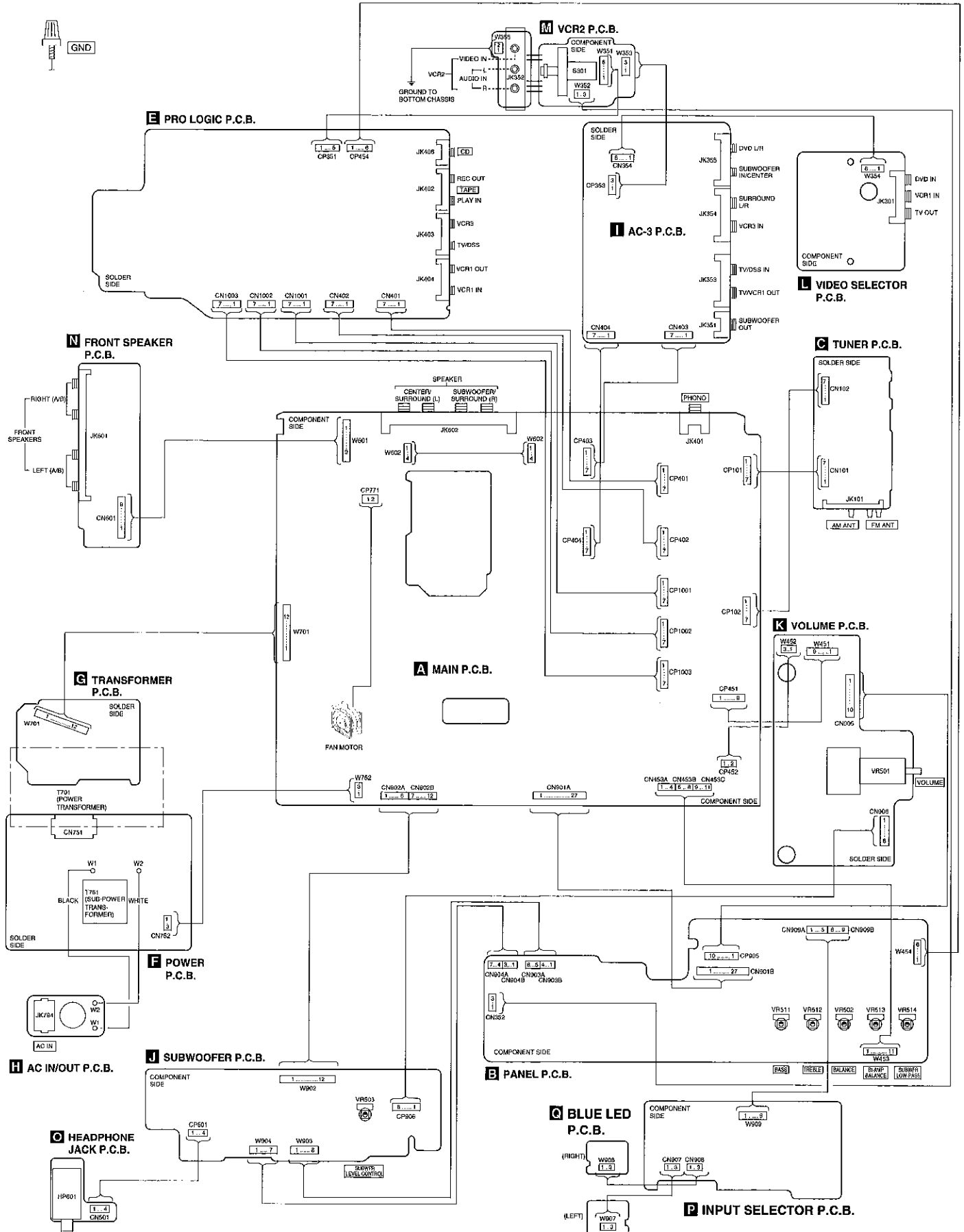

Block Diagram

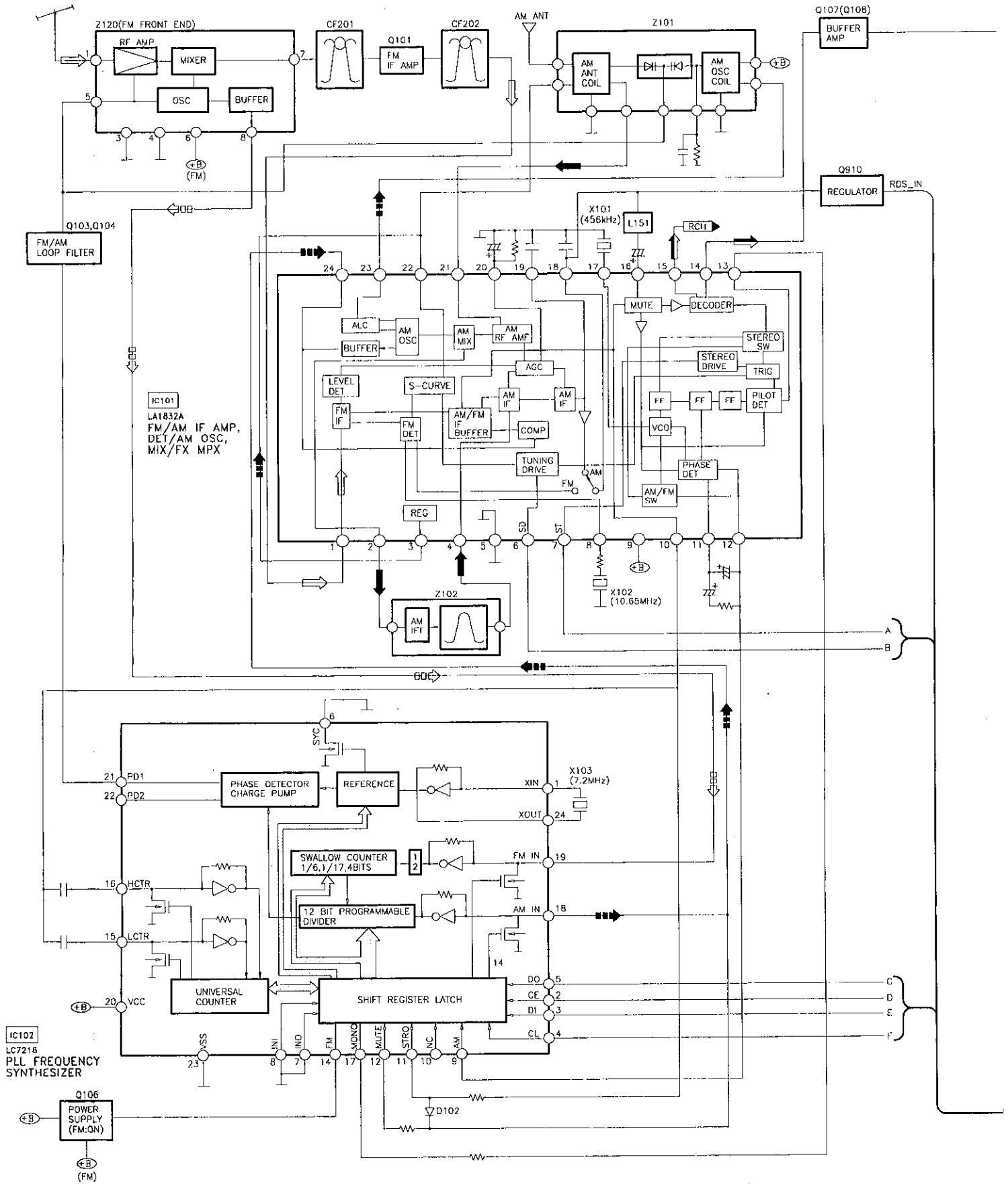

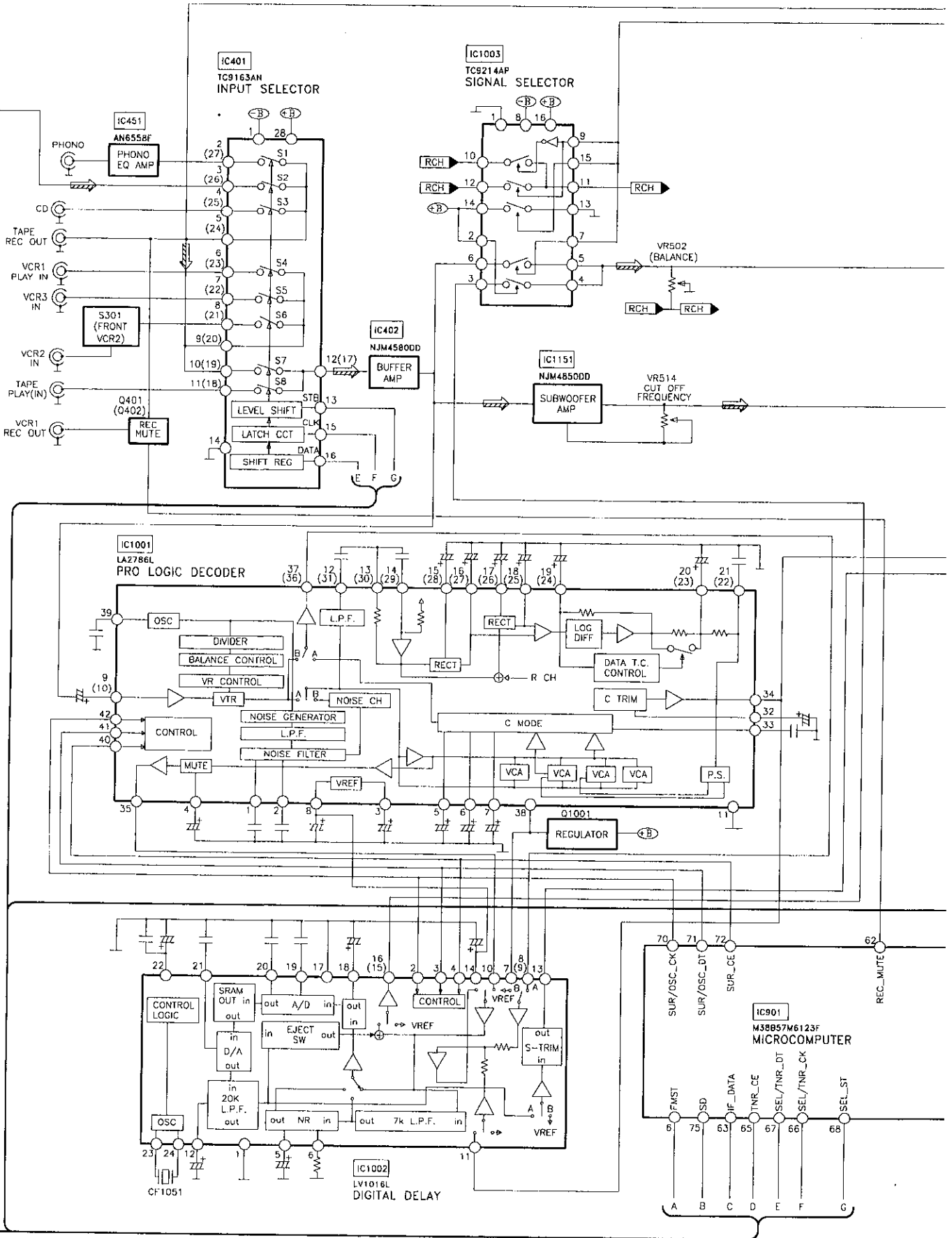

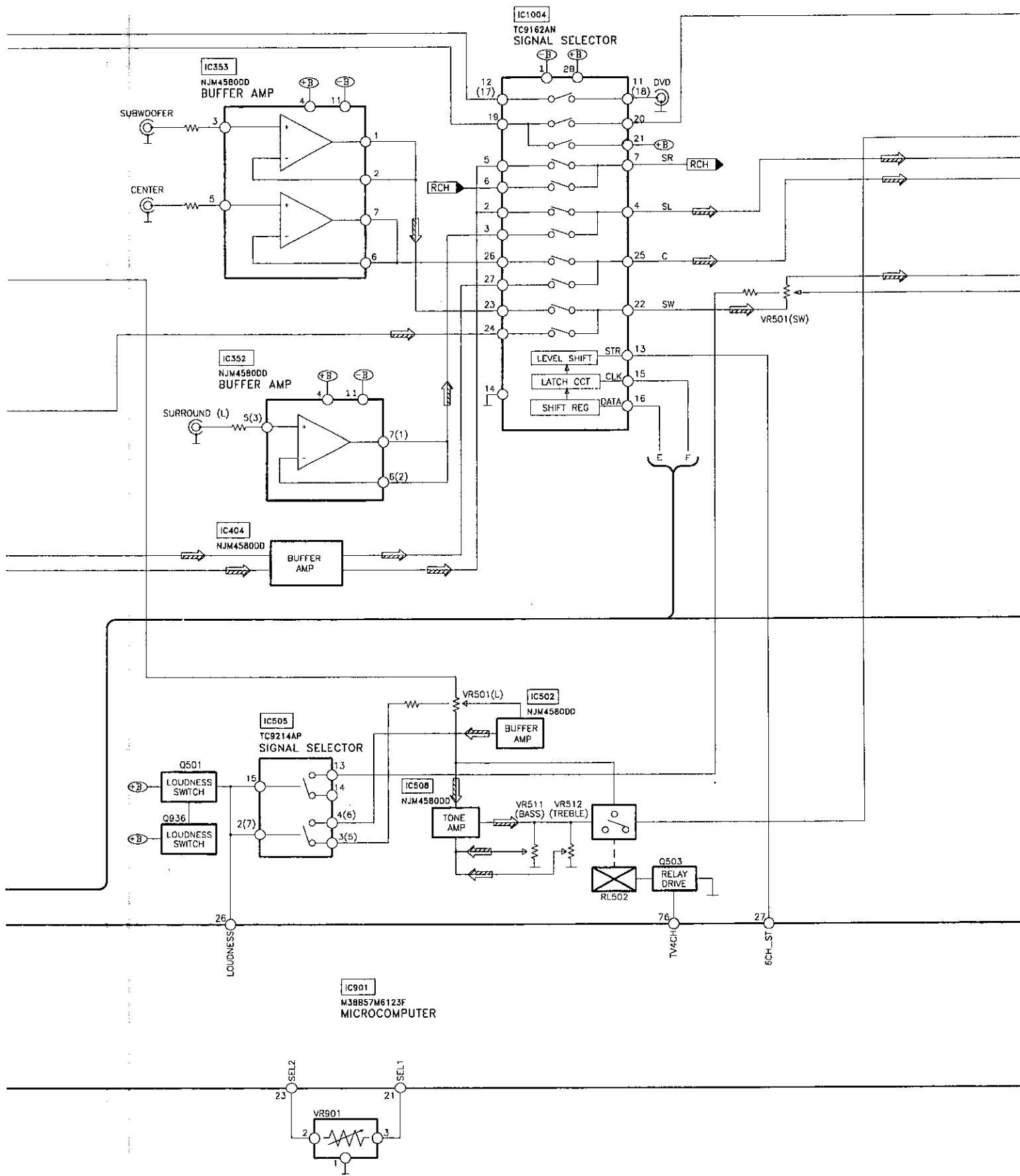

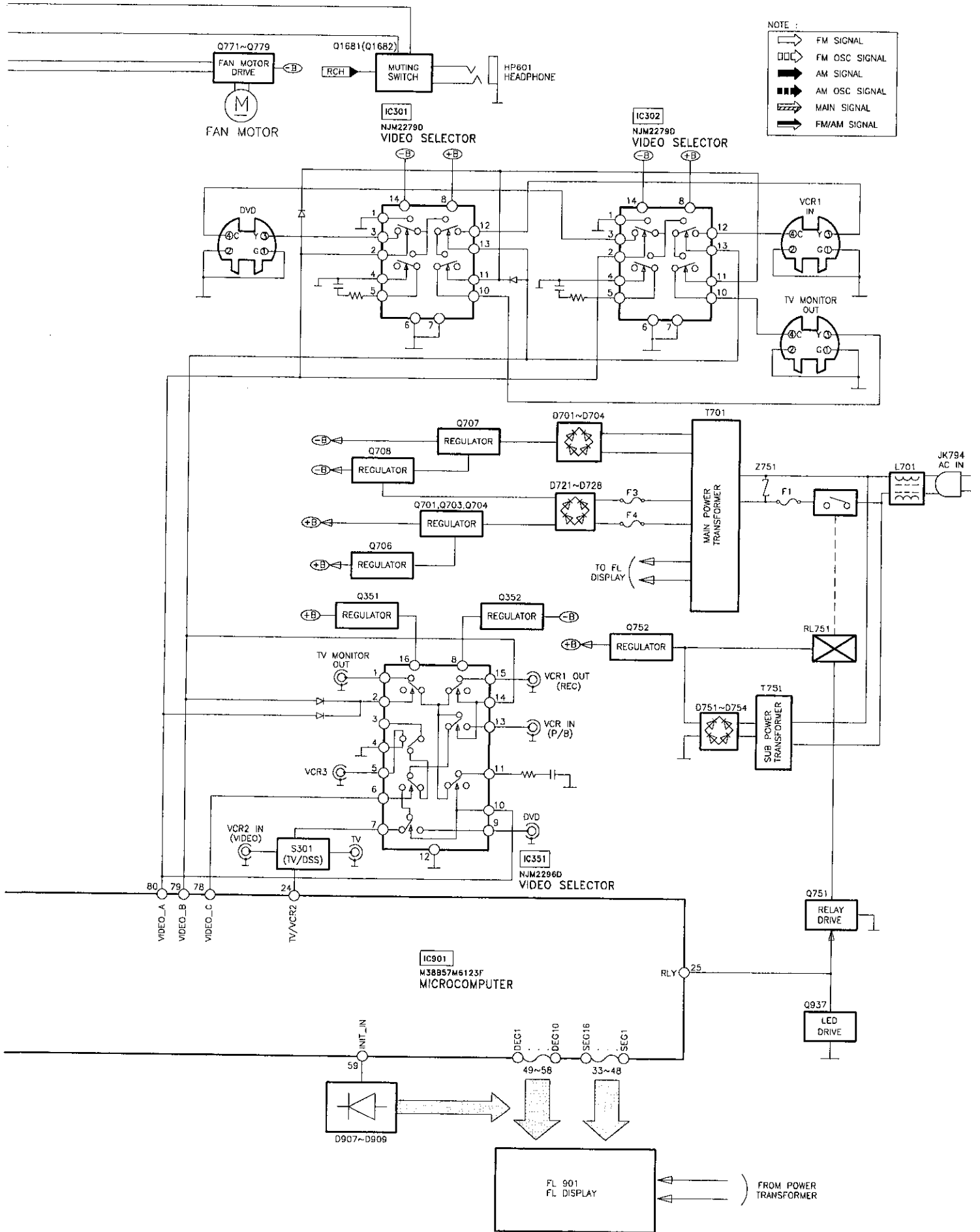

Ref No.	Part No.	Part Name & Description	Remarks	Ref No.	Part No.	Part Name & Description	Remarks	Ref No.	Part No.	Part Name & Description	Remarks
VR514	EWC2SA016B54	VR, SUBWOOFER LFP	[M]	CN903A	RJS1A6604T1	4P TAPING CONNECTOR	[M]	L751	RLQB101KTA-Y	CHOKE COIL	[M]
VR901	EVQVBHFK112B	VR, INPUT SELECTOR	[M]	CN903B	RJS1A6604T1	4P TAPING CONNECTOR	[M]	L901	RLQB101KTA-Y	CHOKE COIL	[M]
				CN904A	RJS1A6603T1	3P TAPING CONNECTOR	[M]	L902	RLQZP101KT-Y	AXIAL COIL	[M]
		SWITCHES		CN904B	RJS1A6604T1	4P TAPING CONNECTOR	[M]	L903	RLQZP101KT-Y	AXIAL COIL	[M]
S301	RSP2D009-J	SWITCH	[M]	CN905	RJU003K010M1	10P B/B CONNECTOR	[M]	L1051	RLQB101KTA-Y	CHOKE COIL	[M]
S946	EVQ21405R	SW, POWER	[M]	CN906	RJU003K008M1	BOARD IN CONNECTOR	[M]	T701	RTP1Q5B004-V	POWER TRANSFORMER	[M] ⚠
S951	EVQ21405R	SW, FM BAND	[M]	CN907	RJS1A6603T1	3P TAPING CONNECTOR	[M]	T751	RTP1I5E006	POWER TRANSFORMER	[M] ⚠
S952	EVQ21405R	SW, TUNER DOWN	[M]	CN908	RJS1A6603T1	3P TAPING CONNECTOR	[M]				
S953	EVQ21405R	SW, TUNER UP	[M]	CN909A	RJS1A6606T1	6P TAPING CONNECTOR	[M]			COMPONENT COMBINATION	
S955	EVQ21405R	SW, MEMORY	[M]	CN909B	RJS1A6603T1	3P TAPING CONNECTOR	[M]				
S956	EVQ21405R	SW, PRESET	[M]	CN1001	RJU100W07	7P CONNECTOR	[M]	Z101	RLA22002M-T	AM ANT. COIL	[M]
S958	EVQ21405R	SW, TIMER	[M]	CN1002	RJU100W07	7P CONNECTOR	[M]	Z102	RLI22006M-T	AM IFT	[M]
S970	EVQ21405R	SW, SEARCH	[M]	CN1003	RJU100W07	7P CONNECTOR	[M]	Z120	ENV17290G1Y	FM TUNER PACK	[M]
S971	EVQ21405R	SW, ECO	[M]	CP101	RJT057W007-1	7P CONNECTOR	[M]	Z751	ERZV10V511CS	ZNR	[M] ⚠
S972	EVQ21405R	SW, PTY +	[M]	CP102	RJT057W007-1	7P CONNECTOR	[M]	Z891	RCD12042TE	REMOTE SENSOR	[M]
S973	EVQ21405R	SW, PTY -	[M]	CP351	RJP5G9YA	5P CONNECTOR	[M]				
S974	EVQ21405R	SW, DISPLAY MODE	[M]	CP353	RJP3G9YA	CONNECTOR	[M]			CERAMIC FILTERS	
S976	EVQ21405R	SW, 6CH	[M]	CP401	RJT100W07	7P CONNECTOR	[M]				
S980	EVQ21405R	SW, SP_A	[M]	CP402	RJT100W07	7P CONNECTOR	[M]	CF201	RLFFETNGD01L	CERAMIC CAPACITOR	[M]
S981	EVQ21405R	SW, SP_B	[M]	CP403	RJT100W07	7P CONNECTOR	[M]	CF202	RLFFETMGD01L	CERAMIC FILTER	[M]
S982	EVQ21405R	SW, LOUD	[M]	CP404	RJT100W07	7P CONNECTOR	[M]	CF901	RVBCST4R00MT	CERAMIC OSCILLATOR	[M]
S983	EVQ21405R	SW, TAPE MONITOR	[M]	CP451	RJP9G4YA	CONNECTOR	[M]	CF1051	RSXY8M00D01T	CERAMIC OSCILLATOR	[M]
S984	EVQ21405R	SW, DVD 6CH	[M]	CP452	SJT3213	CONNECTOR (FAN)	[M]				
S985	EVQ21405R	SW, SURROUND	[M]	CP454	RJP8G9YA	6P CONNECTOR	[M]			RELAY	
S986	EVQ21405R	SW, STEREO	[M]	CP501	RJT100W04	4P CONNECTOR	[M]				
S988	EVQ21405R	SW, BI-WIRE	[M]	CP771	SJT3213	CONNECTOR (FAN)	[M]	RL501	RSY0045M-D	SIGNAL RELAY	[M]
				CP905	RJT003K010M1	10P CONNECTOR	[M]	RL502	RSY0045M-D	SIGNAL RELAY	[M]
		CONNECTORS		CP906	RJT003K008M1	8P CONNECTOR	[M]	RL601	RSY0038-C	RELAY	[M] ⚠
CN101	RJU057W007	7P CONNECTOR	[M]	CP1001	RJT100W07	7P CONNECTOR	[M]	RL602	RSY0038-C	RELAY	[M] ⚠
CN102	RJU057W007	7P CONNECTOR	[M]	CP1002	RJT100W07	7P CONNECTOR	[M]	RL603	RSY0038-C	RELAY	[M] ⚠
CN352	RJS1A6603T1	3P TAPING CONNECTOR	[M]	CP1003	RJT100W07	7P CONNECTOR	[M]	RL604	RSY0038-C	RELAY	[M] ⚠
CN354	RJS1A6606T1	6P TAPING CONNECTOR	[M]					RL605	RSY0038-C	RELAY	[M] ⚠
CN401	RJU100W07	7P CONNECTOR	[M]			COILS & TRANSFORMERS		RL751	RSY0019M-0	12V TV-5 RELAY	[M] ⚠
CN402	RJU100W07	7P CONNECTOR	[M]	L101	ELESN1R0MA	CHOKE COIL	[M]			OSCILLATORS	
CN403	RJU100W07	7P CONNECTOR	[M]	L103	ELETR47MA9	CHOKE COIL	[M]				
CN404	RJU100W07	7P CONNECTOR	[M]	L105	RLQZB822KT-D	TAPING COIL	[M]	X101	RSXZ456KM07M	CERAMIC OSCILLATOR	[M]
CN453A	RJS1A6604T1	4P TAPING CONNECTOR	[M]	L106	RLQZB822KT-D	TAPING COIL	[M]	X102	RLFDGTD01I	FM REZONATOR	[M]
CN453B	RJS1A6604T1	4P TAPING CONNECTOR	[M]	L151	SLM1B10-1M	A.B. FILTER	[M]	X103	RSXD7M20C01	CRYSTAL 7.2 MHZ	[M]
CN453C	RJS1A6603T1	3P TAPING CONNECTOR	[M]	L191	ELESNR58MA	CHOKE COIL	[M]	X901	RSXC4M33S02T	CRYSTAL 4.33 MHZ	[M]
CN501	RJU100W04	4P CONNECTOR	[M]	L501	RLQZP1R0KT-Y	AXIAL COIL	[M]				
CN601	RJS9T62A	CONNECTOR	[M]	L502	RLQZP1R0KT-Y	AXIAL COIL	[M]			DISPLAY TUBE	
CN751	SJS305-1	3P CONNECTOR	[M]	L602	RLQYR73MW-E	CHOKE COIL	[M]	FL901	RSL0256-F	FL	[M]
CN752	RJS1A6603T1	3P TAPING CONNECTOR	[M]	L603	RLQYR73MW-E	CHOKE COIL	[M]				
CN901A	RJS1A9427	FPC CONNECTOR	[M]	L604	RLQYR73MW-E	CHOKE COIL	[M]			FUSES	
CN901B	RJS1A6227-1	FPC CONNECTOR	[M]	L652	RLQYR73MW-E	CHOKE COIL	[M]				
CN902A	RJS1A6606T1	6P TAPING CONNECTOR	[M]	L653	RLQYR73MW-E	CHOKE COIL	[M]	F1	XBA2C31TB0	FUSE	[M] ⚠
CN902B	RJS1A6606T1	6P TAPING CONNECTOR	[M]	L654	RLQYR73MW-E	CHOKE COIL	[M]	F3	XBA2C63TB0	FUSE	[M] ⚠
				L701	SLQZ650MH49	AC LINE COIL	[M] ⚠				

Ref No.	Part No.	Part Name & Description	Remarks	Ref No.	Part No.	Part Name & Description	Remarks	Ref No.	Part No.	Part Name & Description	Remarks
F4	XBA2C63T80	FUSE	[M] ⚠	W452	REX0920	WIRE	[M]				
				W453	RWJ1811160SQ	WIRE	[M]				
		FUSE HOLDERS		W454	REX0921	WIRE	[M]				
				W455	REZ1146	WIRE	[M]				
FC701	RJR0169T	FUSE HOLDER	[M]	W601	RWJ1809150KQ	WIRE	[M]				
FC702	RJR0169T	FUSE HOLDER	[M]	W602	RWJ1804150SS	4P WIRE	[M]				
FC705	RJR0169T	FUSE HOLDER	[M]	W701	RWJ1812220KK	12P WIRE	[M]				
FC706	RJR0169T	FUSE HOLDER	[M]	W752	RWJ1803290SQ	3P WIRE	[M]				
FC707	RJR0169T	FUSE HOLDER	[M]	W901	REE0866	WIRE	[M]				
FC708	RJR0169T	FUSE HOLDER	[M]	W902	RWJ1812300SQ	12P WIRE	[M]				
				W903	RWJ1808170KQ	WIRE	[M]				
		FL HOLDER		W904	RWJ1807170KQ	WIRE	[M]				
				W907	RWJ1803150SQ	3P WIRE	[M]				
HL901	RMN0483	FL HOLDER	[M]	W908	RWJ1803150SQ	3P WIRE	[M]				
				W909	RWJ1809160KQ	WIRE	[M]				
		JACKS									
HP601	RJJ63TA01	HP JACK	[M]								
JK101	RJH4202-1	JK, ANT TERMINAL	[M]								
JK301	RJS1D1304	JK, SPK. TERMINAL	[M]								
JK351	RJH3210N	JK, 2P RCA PIN	[M]								
JK352	SJFK5-2A	JK, VCR IN	[M]								
JK353	SJF3069-12N	JK, LINE IN	[M]								
JK354	SJF3069-9N	JK, LINE IN	[M]								
JK355	SJF3069-13N	JK, LINE IN	[M]								
JK401	SJF3068-7N	JK, RCA TERMINAL	[M]								
JK402	SJF3069N	JK, LINE IN	[M]								
JK403	SJF3069N	JK, LINE IN	[M]								
JK404	SJF3069N	JK, LINE IN	[M]								
JK406	SJF3068-7N	JK, RCA TERMINAL	[M]								
JK601	RJH4802	JK, SPEAKER TERMINAL	[M]								
JK602	RJH4802	JK, SPEAKER TERMINAL	[M]								
JK794	SJS9231-1B	JK, SOCKET	[M] ⚠								
		EARTH TERMINAL									
E401	SNE1004-2	EARTH TERMINAL	[M]								
E601	SNE1004-2	EARTH TERMINAL	[M]								
		WIRES									
W1	REE0889	WIRE	[M]								
W2	REE0890	WIRE	[M]								
W351	REX0918	WIRE	[M]								
W352	RWJ1803100SQ	3P WIRE	[M]								
W353	REX0917	WIRE	[M]								
W354	RWJ1806200KQ	WIRE	[M]								
W355	REZ1127	EARTH WIRE UNIT	[M]								
W451	REX0919	WIRE	[M]								

Resistors & Capacitors

- Notes: * Important safety notice:
 Components identified by Δ mark have special characteristics important for safety.
 Furthermore, special parts which have purposes of fire-retardant (resistors), high-quality sound (capacitors), low noise (resistors), etc are used.
 When replacing any of these components, be sure to use only manufacturer's specified parts shown in the parts list .
- * The parenthesized indications in the Remarks columns specify the areas or colour. (Refer to the cover page for area or colour)
 - Parts without these indications can be used for all areas.
 - * [M] Indicates in the values & remarks column indicates parts supplied by MESA
 - * Capacitor values are in microfarads (μ F) unless specified otherwise, P=Pico-farads (pF), F=Farads (F).
 - * Resistance values are in ohms, unless specified otherwise, 1K=1,000 (OHM), 1M=1,000k (OHM).

Ref. No.	Part No.	Values & Remarks	Ref. No.	Part No.	Values & Remarks	Ref. No.	Part No.	Values & Remarks	Ref. No.	Part No.	Values & Remarks
		RESISTORS	R146	ERDS2TJ821T	820 1/4W [M]	R365	ERDS2TJ102T	1K 1/4W [M]	R426	ERDS2TJ103T	10K 1/4W [M]
			R147	ERDS2TJ474T	470K 1/4W [M]	R367	ERDS2TJ182T	1.8K 1/4W [M]	R427	ERDS2TJ103T	10K 1/4W [M]
R103	ERDS2TJ101T	100 1/4W [M]	R148	ERDS2TJ474T	470K 1/4W [M]	R368	ERDS2TJ182T	1.8K 1/4W [M]	R428	ERDS2TJ332T	3.3K 1/4W [M]
R104	ERDS2TJ102T	1K 1/4W [M]	R149	ERDS2TJ680T	68 1/4W [M]	R369	ERD2FCVG220T	22 1/4W [M]	R429	ERDS2TJ102T	1K 1/4W [M]
R105	ERDS2TJ471T	470 1/4W [M]	R171	ERDS2TJ102T	1K 1/4W [M]	R370	ERD2FCVG220T	22 1/4W [M]	R430	ERDS2TJ102T	1K 1/4W [M]
R106	ERDS2TJ224T	220K 1/4W [M]	R172	ERDS2TJ102T	1K 1/4W [M]	R381	ERDS2TJ104T	100K 1/4W [M]	R431	ERDS2TJ224T	220K 1/4W [M]
R107	ERDS2TJ471T	470 1/4W [M]	R173	ERDS2TJ471T	470 1/4W [M]	R382	ERDS2TJ104T	100K 1/4W [M]	R432	ERDS2TJ224T	220K 1/4W [M]
R110	ERDS2TJ102T	1K 1/4W [M]	R175	ERDS2TJ102T	1K 1/4W [M]	R383	ERDS2TJ473T	47K 1/4W [M]	R433	ERDS2TJ102T	1K 1/4W [M]
R112	ERDS2TJ104T	100K 1/4W [M]	R176	ERDS2TJ391T	390 1/4W [M]	R384	ERDS2TJ473T	47K 1/4W [M]	R434	ERDS2TJ102T	1K 1/4W [M]
R113	ERDS2TJ103T	10K 1/4W [M]	R181	ERDS2TJ332T	3.3K 1/4W [M]	R385	ERDS2TJ104T	100K 1/4W [M]	R435	ERDS2TJ102T	1K 1/4W [M]
R114	ERDS2TJ562T	5.6K 1/4W [M]	R301	ERDS2TJ750T	75 1/4W [M]	R386	ERDS2TJ104T	100K 1/4W [M]	R436	ERDS2TJ102T	1K 1/4W [M]
R115	ERDS2TJ561T	560 1/4W [M]	R302	ERDS2TJ104T	100K 1/4W [M]	R387	ERDS2TJ473T	47K 1/4W [M]	R437	ERDS2TJ473T	47K 1/4W [M]
R116	ERDS2TJ102T	1K 1/4W [M]	R303	ERDS2TJ103T	10K 1/4W [M]	R388	ERDS2TJ473T	47K 1/4W [M]	R440	ERDS1FVJ560T	56 1/2W Δ [M]
R117	ERDS2TJ473T	47K 1/4W [M]	R304	ERDS2TJ750T	75 1/4W [M]	R389	ERDS2TJ104T	100K 1/4W [M]	R441	ERDS2TJ473T	47K 1/4W [M]
R118	ERDS2TJ562T	5.6K 1/4W [M]	R305	ERDS2TJ750T	75 1/4W [M]	R390	ERDS2TJ104T	100K 1/4W [M]	R442	ERDS2TJ473T	47K 1/4W [M]
R119	ERDS2TJ183T	18K 1/4W [M]	R306	ERDS2TJ104T	100K 1/4W [M]	R391	ERDS2TJ104T	100K 1/4W [M]	R443	ERDS1FVJ560T	56 1/2W Δ [M]
R120	ERDS2TJ473T	47K 1/4W [M]	R307	ERDS2TJ103T	10K 1/4W [M]	R392	ERDS2TJ104T	100K 1/4W [M]	R447	ERDS2TJ102T	1K 1/4W [M]
R121	ERDS2TJ332T	3.3K 1/4W [M]	R308	ERDS2TJ750T	75 1/4W [M]	R401	ERDS2TJ102T	1K 1/4W [M]	R448	ERDS2TJ102T	1K 1/4W [M]
R122	ERDS2TJ272T	2.7K 1/4W [M]	R309	ERDS2TJ750T	75 1/4W [M]	R402	ERDS2TJ102T	1K 1/4W [M]	R449	ERDS2TJ102T	1K 1/4W [M]
R124	ERDS2TJ301T	300 1/4W [M]	R310	ERDS2TJ750T	75 1/4W [M]	R405	ERDS2TJ102T	1K 1/4W [M]	R451	ERDS2TJ224T	220K 1/4W [M]
R125	ERDS2TJ472T	4.7K 1/4W [M]	R311	ERDS2TJ750T	75 1/4W [M]	R406	ERDS2TJ102T	1K 1/4W [M]	R452	ERDS2TJ224T	220K 1/4W [M]
R126	ERDS2TJ472T	4.7K 1/4W [M]	R312	ERDS2TJ750T	75 1/4W [M]	R407	ERDS2TJ102T	1K 1/4W [M]	R453	ERDS2TJ391T	390 1/4W [M]
R127	ERDS2TJ103T	10K 1/4W [M]	R313	ERDS2TJ750T	75 1/4W [M]	R408	ERDS2TJ102T	1K 1/4W [M]	R454	ERDS2TJ391T	390 1/4W [M]
R128	ERDS2TJ820T	82 1/4W [M]	R314	ERDS2TJ750T	75 1/4W [M]	R409	ERDS2TJ102T	1K 1/4W [M]	R455	ERDS2TJ563T	56K 1/4W [M]
R129	ERDS2TJ473T	47K 1/4W [M]	R315	ERDS2TJ102T	1K 1/4W [M]	R410	ERDS2TJ102T	1K 1/4W [M]	R456	ERDS2TJ563T	56K 1/4W [M]
R130	ERDS2TJ102T	1K 1/4W [M]	R316	ERDS2TJ102T	1K 1/4W [M]	R411	ERDS2TJ102T	1K 1/4W [M]	R457	ERDS2TJ271T	270 1/4W [M]
R131	ERDS2TJ102T	1K 1/4W [M]	R351	ERDS2TJ750T	75 1/4W [M]	R412	ERDS2TJ102T	1K 1/4W [M]	R458	ERDS2TJ271T	270 1/4W [M]
R132	ERDS2TJ103T	10K 1/4W [M]	R352	ERDS2TJ750T	75 1/4W [M]	R413	ERDS2TJ102T	1K 1/4W [M]	R459	ERDS2TJ680T	68 1/4W [M]
R133	ERDS2TJ102T	1K 1/4W [M]	R353	ERDS2TJ103T	10K 1/4W [M]	R414	ERDS2TJ102T	1K 1/4W [M]	R460	ERDS2TJ680T	68 1/4W [M]
R134	ERDS2TJ102T	1K 1/4W [M]	R354	ERDS2TJ750T	75 1/4W [M]	R415	ERDS2TJ102T	1K 1/4W [M]	R461	ERDS2TJ184T	180K 1/4W [M]
R135	ERDS2TJ102T	1K 1/4W [M]	R355	ERDS2TJ103T	10K 1/4W [M]	R416	ERDS2TJ102T	1K 1/4W [M]	R462	ERDS2TJ184T	180K 1/4W [M]
R136	ERDS2TJ102T	1K 1/4W [M]	R356	ERDS2TJ750T	75 1/4W [M]	R417	ERDS2TJ473T	47K 1/4W [M]	R463	ERDS2TJ123T	12K 1/4W [M]
R137	ERDS2TJ102T	1K 1/4W [M]	R357	ERDS2TJ103T	10K 1/4W [M]	R418	ERDS2TJ473T	47K 1/4W [M]	R464	ERDS2TJ123T	12K 1/4W [M]
R139	ERDS2TJ272T	2.7K 1/4W [M]	R358	ERDS2TJ750T	75 1/4W [M]	R419	ERDS2TJ104T	100K 1/4W [M]	R485	ERDS2TJ563T	56K 1/4W [M]
R140	ERDS2TJ272T	2.7K 1/4W [M]	R359	ERDS2TJ103T	10K 1/4W [M]	R420	ERDS2TJ104T	100K 1/4W [M]	R466	ERDS2TJ563T	56K 1/4W [M]
R141	ERDS2TJ102T	1K 1/4W [M]	R360	ERDS2TJ750T	75 1/4W [M]	R421	ERDS2TJ104T	100K 1/4W [M]	R469	ERDS2TJ102T	1K 1/4W [M]
R142	ERDS2TJ102T	1K 1/4W [M]	R361	ERDS2TJ750T	75 1/4W [M]	R422	ERDS2TJ104T	100K 1/4W [M]	R470	ERDS2TJ102T	1K 1/4W [M]
R143	ERDS2TJ222T	2.2K 1/4W [M]	R362	ERDS2TJ750T	75 1/4W [M]	R423	ERDS2TJ102T	1K 1/4W [M]	R472	ERDS2TJ103T	10K 1/4W [M]
R144	ERDS2TJ222T	2.2K 1/4W [M]	R363	ERDS2TJ102T	1K 1/4W [M]	R424	ERDS2TJ102T	1K 1/4W [M]	R473	ERDS2TJ102T	1K 1/4W [M]
R145	ERDS2TJ821T	820 1/4W [M]	R364	ERDS2TJ102T	1K 1/4W [M]	R425	ERDS2TJ103T	10K 1/4W [M]	R474	ERDS2TJ102T	1K 1/4W [M]

Ref. No.	Part No.	Values & Remarks	Ref. No.	Part No.	Values & Remarks	Ref. No.	Part No.	Values & Remarks	Ref. No.	Part No.	Values & Remarks
R475	ERDS2TJ103T	10K 1/4W [M]	R534	ERDS2TJ272T	2.7K 1/4W [M]	R583	ERDS2TJ331T	330 1/4W [M]	R637	ERDS2TJ154T	150K 1/4W [M]
R476	ERDS2TJ103T	10K 1/4W [M]	R535	ERDS2TJ272T	2.7K 1/4W [M]	R584	ERDS2TJ331T	330 1/4W [M]	R638	ERDS2TJ154T	150K 1/4W [M]
R477	ERDS2TJ103T	10K 1/4W [M]	R536	ERDS2TJ272T	2.7K 1/4W [M]	R585	ERDS2TJ331T	330 1/4W [M]	R639	ERDS2TJ104T	100K 1/4W [M]
R478	ERDS2TJ104T	100K 1/4W [M]	R537	ERDS2TJ103T	10K 1/4W [M]	R586	ERDS2TJ331T	330 1/4W [M]	R640	ERDS2TJ682T	6.8K 1/4W [M]
R481	ERDS2TJ102T	1K 1/4W [M]	R538	ERDS2TJ103T	10K 1/4W [M]	R587	ERDS2TJ102T	1K 1/4W [M]	R641	ERDS2TJ472T	4.7K 1/4W [M]
R482	ERDS2TJ102T	1K 1/4W [M]	R539	ERDS2TJ103T	10K 1/4W [M]	R588	ERDS2TJ102T	1K 1/4W [M]	R642	ERDPS2VF122T	1.2K 1/4W [M]
R483	ERDS2TJ272T	2.7K 1/4W [M]	R540	ERDS2TJ103T	10K 1/4W [M]	R589	ERDS2TJ102T	1K 1/4W [M]	R643	ERDPS2VF563T	56K 1/4W [M]
R484	ERDS2TJ272T	2.7K 1/4W [M]	R541	ERDS2TJ103T	10K 1/4W [M]	R590	ERDS2TJ102T	1K 1/4W [M]	R644	ERDS1FVJ100T	10 1/2W Δ [M]
R485	ERDS2TJ473T	47K 1/4W [M]	R542	ERDS2TJ103T	10K 1/4W [M]	R591	ERDS2TJ103T	10K 1/4W [M]	R645	ERDS2TJ470T	47 1/4W [M]
R486	ERDS2TJ473T	47K 1/4W [M]	R543	ERDS2TJ104T	100K 1/4W [M]	R592	ERDS2TJ684T	680K 1/4W [M]	R647	ERDS2TJ221T	220 1/4W [M]
R491	ERDS2TJ102T	1K 1/4W [M]	R544	ERDS2TJ104T	100K 1/4W [M]	R593	ERDS2TJ103T	10K 1/4W [M]	R648	ERDS2TJ122T	1.2K 1/4W [M]
R492	ERDS2TJ102T	1K 1/4W [M]	R545	ERDS2TJ104T	100K 1/4W [M]	R594	ERDS1FVJ181T	180 1/2W Δ [M]	R651	ERDS2TJ472T	4.7K 1/4W [M]
R493	ERDS2TJ102T	1K 1/4W [M]	R546	ERDS2TJ104T	100K 1/4W [M]	R595	ERDS1FVJ181T	180 1/2W Δ [M]	R652	ERDS2TJ472T	4.7K 1/4W [M]
R494	ERDS2TJ102T	1K 1/4W [M]	R547	ERDS2TJ104T	100K 1/4W [M]	R601	ERDS2TJ472T	4.7K 1/4W [M]	R653	ERDPS2VF122T	1.2K 1/4W [M]
R497	ERDS2TJ104T	100K 1/4W [M]	R548	ERDS2TJ104T	100K 1/4W [M]	R602	ERDS2TJ472T	4.7K 1/4W [M]	R654	ERDPS2VF122T	1.2K 1/4W [M]
R498	ERDS2TJ102T	1K 1/4W [M]	R549	ERDS2TJ223T	22K 1/4W [M]	R603	ERDPS2VF122T	1.2K 1/4W [M]	R655	ERDS2TJ221T	220 1/4W [M]
R501	ERDPS2VF222T	2.2K 1/4W [M]	R550	ERDS2TJ333T	33K 1/4W [M]	R604	ERDPS2VF122T	1.2K 1/4W [M]	R656	ERDS2TJ221T	220 1/4W [M]
R502	ERDPS2VF222T	2.2K 1/4W [M]	R551	ERDS2TJ223T	22K 1/4W [M]	R605	ERDS2TJ221T	220 1/4W [M]	R657	ERDPS2VF563T	56K 1/4W [M]
R503	ERDS2TJ223T	22K 1/4W [M]	R552	ERDS2TJ102T	1K 1/4W [M]	R606	ERDS2TJ221T	220 1/4W [M]	R658	ERDPS2VF563T	56K 1/4W [M]
R504	ERDS2TJ223T	22K 1/4W [M]	R553	ERDS2TJ473T	47K 1/4W [M]	R607	ERDPS2VF563T	56K 1/4W [M]	R659	ERDS2TJ470T	47 1/4W [M]
R505	ERDS2TJ223T	22K 1/4W [M]	R554	ERDS2TJ473T	47K 1/4W [M]	R608	ERDPS2VF563T	56K 1/4W [M]	R660	ERDS2TJ470T	47 1/4W [M]
R508	ERDS2TJ223T	22K 1/4W [M]	R555	ERDS2TJ222T	2.2K 1/4W [M]	R609	ERDS2TJ470T	47 1/4W [M]	R661	ERDS1FVJ100T	10 1/2W Δ [M]
R507	ERDS2TJ684T	680K 1/4W [M]	R556	ERDS2TJ222T	2.2K 1/4W [M]	R610	ERDS2TJ470T	47 1/4W [M]	R662	ERDS1FVJ100T	10 1/2W Δ [M]
R508	ERDS1FVJ2R2T	2.2 1/2W Δ [M]	R557	ERDS2TJ472T	4.7K 1/4W [M]	R611	ERDS1FVJ100T	10 1/2W Δ [M]	R663	ERDS2TJ104T	100K 1/4W [M]
R509	ERDS2TJ182T	1.8K 1/4W [M]	R558	ERDS2TJ472T	4.7K 1/4W [M]	R612	ERDS1FVJ100T	10 1/2W Δ [M]	R664	ERDS2TJ104T	100K 1/4W [M]
R510	ERDS2TJ182T	1.8K 1/4W [M]	R559	ERDS2TJ223T	22K 1/4W [M]	R613	ERDS2TJ222T	2.2K 1/4W [M]	R672	ERDS2TJ223T	22K 1/4W [M]
R511	ERDS2TJ103T	10K 1/4W [M]	R560	ERDS2TJ223T	22K 1/4W [M]	R614	ERDS2TJ222T	2.2K 1/4W [M]	R673	ERDS2TJ223T	22K 1/4W [M]
R512	ERDS2TJ103T	10K 1/4W [M]	R561	ERDS2TJ331T	330 1/4W [M]	R615	ERDS2TJ681T	680 1/4W [M]	R674	ERD25FVJ4R7T	4.7 1/4W [M]
R513	ERDS2TJ474T	470K 1/4W [M]	R562	ERDS2TJ331T	330 1/4W [M]	R616	ERD2FCVG470T	47 1/4W [M]	R675	ERDS2TJ222T	2.2K 1/4W [M]
R514	ERDS2TJ474T	470K 1/4W [M]	R563	ERDS2TJ331T	330 1/4W [M]	R617	ERD2FCVG470T	47 1/4W [M]	R676	ERDS2TJ222T	2.2K 1/4W [M]
R515	ERDS2TJ474T	470K 1/4W [M]	R564	ERDS2TJ331T	330 1/4W [M]	R618	ERD2FCVG470T	47 1/4W [M]	R677	ERDS2TJ222T	2.2K 1/4W [M]
R516	ERDS2TJ474T	470K 1/4W [M]	R565	ERDS2TJ102T	1K 1/4W [M]	R619	ERD2FCVG470T	47 1/4W [M]	R678	ERDS2TJ222T	2.2K 1/4W [M]
R517	ERDS2TJ223T	22K 1/4W [M]	R566	ERDS2TJ102T	1K 1/4W [M]	R620	ERD2FCVG470T	47 1/4W [M]	R679	ERDS2TJ102T	1K 1/4W [M]
R518	ERDS2TJ223T	22K 1/4W [M]	R667	ERDS2TJ102T	1K 1/4W [M]	R621	ERDS2TJ682T	6.8K 1/4W [M]	R680	ERDS2TJ124T	120K 1/4W [M]
R519	ERDS2TJ122T	1.2K 1/4W [M]	R568	ERDS2TJ102T	1K 1/4W [M]	R622	ERDS2TJ682T	6.8K 1/4W [M]	R681	ERDS2TJ154T	150K 1/4W [M]
R520	ERDS2TJ122T	1.2K 1/4W [M]	R569	ERDS2TJ223T	22K 1/4W [M]	R623	ERDS2TJ682T	6.8K 1/4W [M]	R682	ERDS2TJ184T	180K 1/4W [M]
R521	ERDS2TJ273T	27K 1/4W [M]	R570	ERDS2TJ682T	6.8K 1/4W [M]	R624	ERD25FVJ4R7T	4.7 1/4W [M]	R683	ERDS2TJ473T	47K 1/4W [M]
R522	ERDS2TJ273T	27K 1/4W [M]	R571	ERDS2TJ331T	330 1/4W [M]	R625	ERG1SJ101E	100 1W Δ [M]	R684	ERDS2TJ474T	470K 1/4W [M]
R623	ERDS2TJ472T	4.7K 1/4W [M]	R572	ERDS2TJ331T	330 1/4W [M]	R626	ERG1SJ101E	100 1W Δ [M]	R685	ERDS2TJ103T	10K 1/4W [M]
R524	ERDS2TJ472T	4.7K 1/4W [M]	R573	ERDS2TJ331T	330 1/4W [M]	R627	ERG1SJ101E	100 1W Δ [M]	R686	ERDS2TJ473T	47K 1/4W [M]
R525	ERDS2TJ472T	4.7K 1/4W [M]	R574	ERDS2TJ331T	330 1/4W [M]	R628	ERG1SJ101E	100 1W Δ [M]	R687	ERDS2TJ154T	150K 1/4W [M]
R526	ERDS2TJ472T	4.7K 1/4W [M]	R575	ERDS2TJ102T	1K 1/4W [M]	R629	ERDS2TJ102T	1K 1/4W [M]	R688	ERDS2TJ154T	150K 1/4W [M]
R527	ERDS2TJ152T	1.5K 1/4W [M]	R576	ERDS2TJ102T	1K 1/4W [M]	R630	ERDS2TJ124T	120K 1/4W [M]	R691	ERDS2TJ472T	4.7K 1/4W [M]
R528	ERDS2TJ152T	1.5K 1/4W [M]	R577	ERDS2TJ102T	1K 1/4W [M]	R631	ERDS2TJ154T	150K 1/4W [M]	R692	ERDS2TJ122T	1.2K 1/4W [M]
R529	ERDS2TJ563T	56K 1/4W [M]	R578	ERDS2TJ102T	1K 1/4W [M]	R632	ERDS2TJ184T	180K 1/4W [M]	R693	ERDS2TJ563T	56K 1/4W [M]
R530	ERDS2TJ563T	56K 1/4W [M]	R579	ERDS2TJ473T	47K 1/4W [M]	R633	ERDS2TJ473T	47K 1/4W [M]	R694	ERDS1FVJ100T	10 1/2W Δ [M]
R531	ERDS2TJ331T	330 1/4W [M]	R580	ERDS2TJ473T	47K 1/4W [M]	R634	ERDS2TJ474T	470K 1/4W [M]	R695	ERDS2TJ470T	47 1/4W [M]
R532	ERDS2TJ331T	330 1/4W [M]	R581	ERDS2TJ473T	47K 1/4W [M]	R635	ERDS2TJ103T	10K 1/4W [M]	R697	ERDS2TJ221T	220 1/4W [M]
R533	ERDS2TJ272T	2.7K 1/4W [M]	R582	ERDS2TJ473T	47K 1/4W [M]	R636	ERDS2TJ473T	47K 1/4W [M]	R698	ERDS2TJ222T	2.2K 1/4W [M]

Ref. No.	Part No.	Values & Remarks	Ref. No.	Part No.	Values & Remarks	Ref. No.	Part No.	Values & Remarks	Ref. No.	Part No.	Values & Remarks
R699	ERDS2TJ222T	2.2K 1/4W [M]	R803	ERDS2TJ473T	47K 1/4W [M]	R948	ERDS2TJ103T	10K 1/4W [M]	R1013	ERDS2TJ103T	10K 1/4W [M]
R703	ERDS1FVJ3R9T	3.9 1/2W Δ [M]	R804	ERDS2TJ332T	3.3K 1/4W [M]	R949	ERDS2TJ103T	10K 1/4W [M]	R1014	ERDS2TJ104T	100K 1/4W [M]
R704	ERDS1FVJ3R9T	3.9 1/2W Δ [M]	R805	ERDS2TJ102T	1K 1/4W [M]	R950	ERDS2TJ102T	1K 1/4W [M]	R1015	ERD2FCVJ4R7T	4.7 1/4W [M]
R705	ERDS2TJ472T	4.7K 1/4W [M]	R891	ERDS2TJ103T	10K 1/4W [M]	R951	ERDS2TJ122T	1.2K 1/4W [M]	R1051	ERDS2TJ393T	39K 1/4W [M]
R706	ERDS2TJ102T	1K 1/4W [M]	R892	ERDS2TJ103T	10K 1/4W [M]	R952	ERDS2TJ152T	1.5K 1/4W [M]	R1052	ERDS2TJ105T	1M 1/4W [M]
R707	ERD25FVJ221T	220 1/4W [M]	R893	ERDS2TJ103T	10K 1/4W [M]	R953	ERDS2TJ182T	1.8K 1/4W [M]	R1053	ERDS2TJ102T	1K 1/4W [M]
R708	ERDS2TJ152T	1.5K 1/4W [M]	R894	ERDS2TJ103T	10K 1/4W [M]	R954	ERDS2TJ222T	2.2K 1/4W [M]	R1055	ERDS2TJ224T	220K 1/4W [M]
R709	ERDS2TJ1R5T	1.5 1/4W [M]	R900	ERDS2TJ472T	4.7K 1/4W [M]	R955	ERDS2TJ332T	3.3K 1/4W [M]	R1056	ERDS2TJ153T	15K 1/4W [M]
R710	ERDS2TJ1R5T	1.5 1/4W [M]	R901	ERDS2TJ102T	1K 1/4W [M]	R956	ERDS2TJ472T	4.7K 1/4W [M]	R1061	ERDS2TJ222T	2.2K 1/4W [M]
R711	ERDS2TJ752T	7.5K 1/4W [M]	R903	ERDS2TJ104T	100K 1/4W [M]	R957	ERDS2TJ682T	6.8K 1/4W [M]	R1062	ERDS2TJ273T	27K 1/4W [M]
R712	ERDS2TJ682T	6.8K 1/4W [M]	R904	ERDS2TJ271T	270 1/4W [M]	R958	ERDS2TJ123T	12K 1/4W [M]	R1063	ERDS2TJ332T	3.3K 1/4W [M]
R713	ERDS2TJ390T	39 1/4W [M]	R906	ERDS2TJ222T	2.2K 1/4W [M]	R959	ERDS2TJ103T	10K 1/4W [M]	R1151	ERDS2TJ473T	47K 1/4W [M]
R714	ERDS2TJ390T	39 1/4W [M]	R907	ERDS2TJ104T	100K 1/4W [M]	R960	ERDS2TJ332T	3.3K 1/4W [M]	R1152	ERDS2TJ473T	47K 1/4W [M]
R721	ERDS1FVJ221T	220 1/2W Δ [M]	R908	ERDS2TJ104T	100K 1/4W [M]	R961	ERDS2TJ332T	3.3K 1/4W [M]	R1154	ERDS2TJ183T	18K 1/4W [M]
R722	ERDS2TJ682T	6.8K 1/4W [M]	R909	ERDS2TJ473T	47K 1/4W [M]	R962	ERDS2TJ103T	10K 1/4W [M]	R1155	ERDS2TJ103T	10K 1/4W [M]
R723	ERDS1FVJ100T	10 1/2W Δ [M]	R910	ERDS2TJ102T	1K 1/4W [M]	R963	ERDS2TJ105T	1M 1/4W [M]	R1156	ERDS2TJ103T	10K 1/4W [M]
R724	ERDS1FVJ100T	10 1/2W Δ [M]	R911	ERDS2TJ104T	100K 1/4W [M]	R964	ERDS2TJ105T	1M 1/4W [M]	R1158	ERDS2TJ104T	100K 1/4W [M]
R725	ERDS2TJ152T	1.5K 1/4W [M]	R913	ERDS2TJ103T	10K 1/4W [M]	R970	ERDS2TJ102T	1K 1/4W [M]	R1160	ERDS2TJ104T	100K 1/4W [M]
R726	ERD25FVJ151T	150 1/4W [M]	R915	ERDS2TJ222T	2.2K 1/4W [M]	R971	ERDS2TJ122T	1.2K 1/4W [M]	R1681	ERDS2TJ270T	27 1/4W [M]
R727	ERD25FVJ151T	150 1/4W [M]	R917	ERDS2TJ103T	10K 1/4W [M]	R972	ERDS2TJ152T	1.5K 1/4W [M]	R1682	ERDS2TJ270T	27 1/4W [M]
R728	ERDS2TJ274T	270K 1/4W [M]	R918	ERDS2TJ102T	1K 1/4W [M]	R973	ERDS2TJ182T	1.8K 1/4W [M]	R1683	ERDS2TJ270T	27 1/4W [M]
R729	ERDS2TJ274T	270K 1/4W [M]	R919	ERDS2TJ102T	1K 1/4W [M]	R974	ERDS2TJ222T	2.2K 1/4W [M]	R1684	ERDS2TJ270T	27 1/4W [M]
R730	ERDS1FVJ1R0T	1 1/2W Δ [M]	R920	ERDS2TJ271T	270 1/4W [M]	R975	ERDS2TJ223T	22K 1/4W [M]	R1685	ERDS2TJ270T	27 1/4W [M]
R754	ERDS2TJ102T	1K 1/4W [M]	R921	ERDS2TJ121T	120 1/4W [M]	R976	ERDS2TJ223T	22K 1/4W [M]	R1686	ERDS2TJ270T	27 1/4W [M]
R756	ERDS2TJ222T	2.2K 1/4W [M]	R922	ERDS2TJ472T	4.7K 1/4W [M]	R977	ERDS2TJ102T	1K 1/4W [M]	R1687	ERDS2TJ270T	27 1/4W [M]
R771	ERDS2TJ104T	100K 1/4W [M]	R923	ERDS2TJ472T	4.7K 1/4W [M]	R978	ERDS2TJ102T	1K 1/4W [M]	R1688	ERDS2TJ270T	27 1/4W [M]
R773	ERDS2TJ103T	10K 1/4W [M]	R924	ERDS2TJ103T	10K 1/4W [M]	R980	ERDS2TJ102T	1K 1/4W [M]	R1689	ERDS2TJ270T	27 1/4W [M]
R774	ERDS2TJ155T	1.5M 1/4W [M]	R926	ERDS2TJ181T	180 1/4W [M]	R981	ERDS2TJ122T	1.2K 1/4W [M]	R1690	ERDS2TJ270T	27 1/4W [M]
R775	ERDS2TJ331T	330 1/4W [M]	R927	ERDS2TJ221T	220 1/4W [M]	R982	ERDS2TJ152T	1.5K 1/4W [M]	R1691	ERDS2TJ270T	27 1/4W [M]
R776	ERDS1FVJ150T	15 1/2W Δ [M]	R928	ERDS2TJ271T	270 1/4W [M]	R983	ERDS2TJ182T	1.8K 1/4W [M]	R1692	ERDS2TJ270T	27 1/4W [M]
R777	ERDS2TJ154T	150K 1/4W [M]	R929	ERDS2TJ101T	100 1/4W [M]	R984	ERDS2TJ222T	2.2K 1/4W [M]	R1693	ERDS2TJ270T	27 1/4W [M]
R778	ERDS2TJ472T	4.7K 1/4W [M]	R930	ERDS2TJ101T	100 1/4W [M]	R985	ERDS2TJ332T	3.3K 1/4W [M]	R1694	ERDS2TJ270T	27 1/4W [M]
R779	ERDS2TJ103T	10K 1/4W [M]	R931	ERDS2TJ271T	270 1/4W [M]	R986	ERDS2TJ472T	4.7K 1/4W [M]	R1695	ERDS2TJ102T	1K 1/4W [M]
R780	ERD25FVJ100T	10 1/4W Δ [M]	R932	ERDS2TJ271T	270 1/4W [M]	R987	ERDS2TJ682T	6.8K 1/4W [M]	R1696	ERDS2TJ102T	1K 1/4W [M]
R781	ERDS2TJ101T	100 1/4W [M]	R933	ERDS2TJ271T	270 1/4W [M]	R989	ERDS2TJ104T	100K 1/4W [M]	R1699	ERDS2TJ332T	3.3K 1/4W [M]
R782	ERDS2TJ390T	39 1/4W [M]	R934	ERDS2TJ271T	270 1/4W [M]	R992	ERDS2TJ104T	100K 1/4W [M]			
R784	ERDS2TJ154T	150K 1/4W [M]	R935	ERDS2TJ271T	270 1/4W [M]	R997	ERDS2TJ101T	100 1/4W [M]		CAPACITORS	
R786	ERDS2TJ154T	150K 1/4W [M]	R936	ERDS2TJ271T	270 1/4W [M]	R998	ERDS2TJ101T	100 1/4W [M]			
R791	ERDS2TJ123T	12K 1/4W [M]	R937	ERDS2TJ271T	270 1/4W [M]	R1001	ERDS2TJ102T	1K 1/4W [M]	C101	ECBT1C103NS5	0.01 16V [M]
R792	ERDS2TJ123T	12K 1/4W [M]	R938	ERDS2TJ271T	270 1/4W [M]	R1002	ERDS2TJ102T	1K 1/4W [M]	C103	ECBT1C103NS5	0.01 16V [M]
R793	ERDS2TJ123T	12K 1/4W [M]	R939	ERDS2TJ151T	150 1/4W [M]	R1003	ERDS2TJ102T	1K 1/4W [M]	C104	ECBT1H102KB5	1000P 50V [M]
R794	ERDS2TJ123T	12K 1/4W [M]	R940	ERDS2TJ222T	2.2K 1/4W [M]	R1004	ERDS2TJ102T	1K 1/4W [M]	C105	ECBT1H470J5	47P 50V [M]
R795	ERDS2TJ223T	22K 1/4W [M]	R941	ERDS2TJ473T	47K 1/4W [M]	R1005	ERDS2TJ203T	20K 1/4W [M]	C106	ECBT1C103NS5	0.01 16V [M]
R796	ERDS2TJ223T	22K 1/4W [M]	R942	ERDS2TJ181T	180 1/4W [M]	R1007	ERDS2TJ473T	47K 1/4W [M]	C107	ECBT1H473ZF5	0.047 50V [M]
R797	ERDS2TJ223T	22K 1/4W [M]	R943	ERDS2TJ102T	1K 1/4W [M]	R1008	ERDS2TJ473T	47K 1/4W [M]	C108	ECBT1H8R2KC5	8.2P 50V [M]
R798	ERDS2TJ223T	22K 1/4W [M]	R944	ERDS2TJ104T	100K 1/4W [M]	R1009	ERDS2TJ332T	3.3K 1/4W [M]	C109	ECBT1C103NS5	0.01 16V [M]
R799	ERDS2TJ682T	6.8K 1/4W [M]	R945	ERDS2TJ104T	100K 1/4W [M]	R1010	ERDS2TJ332T	3.3K 1/4W [M]	C110	ECBT1C103NS5	0.01 16V [M]
R801	ERDS2TJ103T	10K 1/4W [M]	R946	ERDS2TJ103T	10K 1/4W [M]	R1011	ERDS2TJ332T	3.3K 1/4W [M]	C111	ECEA1EKA4R7B	4.7 25V [M]
R802	ERDS2TJ183T	18K 1/4W [M]	R947	ERDS2TJ103T	10K 1/4W [M]	R1012	ERDS2TJ102T	1K 1/4W [M]	C112	ECBT1C103NS5	0.01 16V [M]

Ref. No.	Part No.	Values & Remarks	Ref. No.	Part No.	Values & Remarks	Ref. No.	Part No.	Values & Remarks	Ref. No.	Part No.	Values & Remarks
C113	ECBT1H102KB5	1000P 50V [M]	C305	ECBT1H470J5	47P 50V [M]	C416	ECBT1E103ZF5	0.01 25V [M]	C482	ECBT1H681KB5	680P 50V [M]
C114	ECEA1HKA3R3B	3.3 50V [M]	C306	ECBT1H470J5	47P 50V [M]	C417	ECBT1H101KB5	100P 50V [M]	C483	ECA1EPXS100B	10 25V [M]
C115	ECEA1EKA4R7B	4.7 25V [M]	C307	ECBT1H470J5	47P 50V [M]	C418	ECBT1H101KB5	100P 50V [M]	C484	ECA1EPXS100B	10 25V [M]
C116	ECBT1C822MS5	8200P 16V [M]	C308	ECBT1H470J5	47P 50V [M]	C419	ECBT1H331KB5	330P 50V [M]	C485	ECA1EPXS100B	10 25V [M]
C117	ECQB1H471JM3	470P 50V [M]	C309	ECBT1H104ZF5	0.1 50V [M]	C420	ECBT1H331KB5	330P 50V [M]	C486	ECA1EPXS100B	10 25V [M]
C118	ECQB1H103JM3	0.01 50V [M]	C310	ECBT1H104ZF5	0.1 50V [M]	C421	ECBT1H331KB5	330P 50V [M]	C487	ECBT1H101KB5	100P 50V [M]
C119	ECQB1H103JM3	0.01 50V [M]	C311	ECBT1H104ZF5	0.1 50V [M]	C422	ECBT1H331KB5	330P 50V [M]	C488	ECBT1H101KB5	100P 50V [M]
C120	ECEA1HKA010B	1 50V [M]	C312	ECBT1H104ZF5	0.1 50V [M]	C423	ECBT1H101KB5	100P 50V [M]	C489	ECBT1E103ZF5	0.01 25V [M]
C121	ECEA1HKA010B	1 50V [M]	C313	ECEA0JKA101B	100 6.3V [M]	C424	ECBT1H101KB5	100P 50V [M]	C490	ECBT1E103ZF5	0.01 25V [M]
C122	ECEA1HKA2R2B	2.2 50V [M]	C314	ECEA0JKA101B	100 6.3V [M]	C425	ECBT1H101KB5	100P 50V [M]	C491	ECBT1H331KB5	330P 50V [M]
C123	ECEA1HKA010B	1 50V [M]	C351	ECEA1CKA470B	47 16V [M]	C426	ECBT1H101KB5	100P 50V [M]	C492	ECBT1H331KB5	330P 50V [M]
C124	ECBT1H102KB5	1000P 50V [M]	C352	ECEA1CKA470B	47 16V [M]	C427	ECBT1H221KB5	220P 50V [M]	C493	ECBT1H331KB5	330P 50V [M]
C125	ECBT1H150JC5	15P 50V [M]	C353	ECEA1CKA470B	47 16V [M]	C428	ECBT1H221KB5	220P 50V [M]	C494	ECBT1H331KB5	330P 50V [M]
C126	ECBT1H104ZF5	0.1 50V [M]	C354	ECEA1CKA470B	47 16V [M]	C429	ECBT1H101KB5	100P 50V [M]	C497	ECEA1HKA3R3B	3.3 50V [M]
C127	ECEA1CKA220B	22 16V [M]	C355	ECBT1H470J5	47P 50V [M]	C430	ECBT1H101KB5	100P 50V [M]	C498	ECBT1H101KB5	100P 50V [M]
C128	ECBT1C103NS5	0.01 16V [M]	C356	ECBT1H470J5	47P 50V [M]	C431	ECA1EPXS100B	10 25V [M]	C503	ECEA0JKA101B	100 6.3V [M]
C129	ECEA0JKA101B	100 6.3V [M]	C357	ECBT1H470J5	47P 50V [M]	C432	ECA1EPXS100B	10 25V [M]	C504	ECEA0JKA101B	100 6.3V [M]
C130	ECEA0JKA101B	100 6.3V [M]	C358	ECBT1E103ZF5	0.01 25V [M]	C433	ECBT1H101KB5	100P 50V [M]	C505	ECQV1H104JZ3	0.1 60V [M]
C131	ECBT1C103NS5	0.01 16V [M]	C359	ECBT1H104ZF5	0.1 50V [M]	C434	ECBT1H101KB5	100P 50V [M]	C506	ECQV1H104JZ3	0.1 50V [M]
C132	ECBT1H102KB5	1000P 50V [M]	C360	ECBT1H104ZF5	0.1 50V [M]	C435	ECBT1H101KB5	100P 50V [M]	C508	ECQV1H473JZ3	0.047 50V [M]
C133	ECBT1H150JC5	15P 50V [M]	C361	ECEA0JKA101B	100 6.3V [M]	C436	ECBT1H101KB5	100P 50V [M]	C509	ECQV1H473JZ3	0.047 50V [M]
C134	ECBT1H180JC5	18P 50V [M]	C362	ECEA0JKA101B	100 6.3V [M]	C439	ECBT1E103ZF5	0.01 25V [M]	C510	ECQV1H473JZ3	0.047 50V [M]
C135	ECBT1C103MS5	0.01 16V [M]	C363	ECEA0JKA101B	100 6.3V [M]	C440	ECBT1E103ZF5	0.01 25V [M]	C511	ECA1HPXS4R7B	4.7 50V [M]
C136	ECBT1C103MS5	0.01 16V [M]	C364	ECEA0JKA101B	100 6.3V [M]	C441	ECEA1HKN3R3B	3.3 50V [M]	C512	ECA1HPXS4R7B	4.7 50V [M]
C137	ECBT1H561KB5	560P 50V [M]	C365	ECBT1E103ZF5	0.01 25V [M]	C451	ECEA1VKA4R7B	4.7 35V [M]	C513	ECBT1H101KB5	100P 50V [M]
C138	ECBT1H561KB5	560P 50V [M]	C366	ECBT1E103ZF5	0.01 25V [M]	C452	ECEA1VKA4R7B	4.7 35V [M]	C514	ECBT1H101KB5	100P 50V [M]
C139	ECQB1H682JM3	6800P 50V [M]	C381	ECA1HPXS4R7B	4.7 50V [M]	C453	ECBT1H100J5	10P 50V [M]	C515	ECBT1H221KB5	220P 50V [M]
C140	ECQB1H682JM3	6800P 50V [M]	C382	ECA1HPXS4R7B	4.7 50V [M]	C454	ECBT1H100J5	10P 50V [M]	C516	ECBT1H221KB5	220P 50V [M]
C141	ECEA1HKA010B	1 50V [M]	C383	ECA1HPXS4R7B	4.7 50V [M]	C455	ECBT1H102KB5	1000P 50V [M]	C517	ECBT1H330J5	33P 50V [M]
C142	ECEA1HKA010B	1 50V [M]	C384	ECA1HPXS4R7B	4.7 50V [M]	C456	ECBT1H102KB5	1000P 50V [M]	C518	ECBT1H330J5	33P 50 [M]
C143	ECEA1HKA010B	1 50V [M]	C385	ECA1EPXS100B	10 25V [M]	C457	ECEA1AKA330B	33 10V [M]	C519	ECA1HPXS4R7B	4.7 50V [M]
C144	ECEA1HKA010B	1 50V [M]	C386	ECA1EPXS100B	10 25V [M]	C458	ECEA1AKA330B	33 10V [M]	C520	ECA1HPXS4R7B	4.7 50V [M]
C145	ECBT1H220JC5	22P 50V [M]	C387	ECA1EPXS100B	10 25V [M]	C459	ECFR1E223KR	0.022 25V [M]	C521	ECA1HPXS4R7B	4.7 50V [M]
C146	ECBT1H331KB5	330P 50V [M]	C388	ECA1EPXS100B	10 25V [M]	C460	ECFR1E223KR	0.022 25V [M]	C522	ECA1HPXS4R7B	4.7 50V [M]
C147	ECBT1H102KB5	1000P 50V [M]	C389	ECA1EPXS100B	10 25V [M]	C461	ECFR1E682KR	6800P 25V [M]	C523	ECQB1H123JM3	0.01 250V [M]
C148	ECBT1C103NS5	0.01 16V [M]	C390	ECA1EPXS100B	10 25V [M]	C462	ECFR1E682KR	6800P 25V [M]	C524	ECQB1H123JM3	0.012 50V [M]
C149	ECBT1C103NS5	0.01 16V [M]	C401	ECA1HPXS4R7B	4.7 50V [M]	C463	ECEA1VKA4R7B	4.7 35V [M]	C525	ECQV1H683JM3	0.068 50V [M]
C150	ECBT1H104ZF5	0.1 50V [M]	C402	ECA1HPXS4R7B	4.7 50V [M]	C464	ECEA1VKA4R7B	4.7 35V [M]	C526	ECQV1H683JM3	0.068 50V [M]
C172	ECBT1H331KB5	330P 50V [M]	C403	ECBT1E103ZF5	0.01 25V [M]	C465	ECBT1E103ZF5	0.01 25V [M]	C527	ECQB1H562JF3	5600P 50V [M]
C173	ECEA1CKA220B	22 16V [M]	C404	ECBT1E103ZF5	0.01 25V [M]	C466	ECBT1E103ZF5	0.01 25V [M]	C528	ECQB1H562JF3	5600P 50V [M]
C174	ECEA1CKA101B	100 16V [M]	C405	ECBT1H101KB5	100P 50V [M]	C469	ECBT1H181KB5	180P 50V [M]	C529	ECQV1H273JM3	0.027 50V [M]
C175	ECBT1C103NS5	0.01 16V [M]	C406	ECBT1H101KB5	100P 50V [M]	C470	ECBT1H181KB5	180P 50V [M]	C530	ECQV1H273JM3	0.027 50V [M]
C176	ECBT1C103NS5	0.01 16V [M]	C409	ECA1EPXS100B	10 25V [M]	C471	ECA1HPXS4R7B	4.7 50V [M]	C531	ECBT1E103ZF5	0.01 25V [M]
C181	ECBT1H471KB5	470P 50V [M]	C410	ECA1EPXS100B	10 25V [M]	C472	ECA1HPXS4R7B	4.7 50V [M]	C532	ECBT1E103ZF5	0.01 25V [M]
C196	ECBT1H102KB5	1000P 50V [M]	C411	ECBT1H101KB5	100P 50V [M]	C473	ECBT1E103ZF5	0.01 25V [M]	C533	ECA1EPXS470B	47 25V [M]
C301	ECEA1CKA470B	47 16V [M]	C412	ECBT1H101KB5	100P 50V [M]	C474	ECBT1E103ZF5	0.01 25V [M]	C534	ECA1EPXS470B	47 25V [M]
C302	ECBT1E223ZF5	0.022 25V [M]	C413	ECA1EPXS100B	10 25V [M]	C475	ECBT1H101KB5	100P 50V [M]	C535	ECA1EPXS470B	47 25V [M]
C303	ECEA1CKA470B	47 16V [M]	C414	ECA1EPXS100B	10 25V [M]	C477	ECBT1H102KB5	1000P 50V [M]	C536	ECA1EPXS470B	47 25V [M]
C304	ECBT1E223ZF5	0.022 25V [M]	C415	ECBT1E103ZF5	0.01 25V [M]	C481	ECBT1H681KB5	680P 50V [M]	C537	ECA1EPXS470B	47 25V [M]

Ref. No.	Part No.	Values & Remarks	Part No.	Values & Remarks	Ref. No.	Part No.	Values & Remarks	Ref. No.	Part No.	Values & Remarks	
C538	ECA1EPXS470B	47 25V [M]	C607	ECCR1H180KC5	18P 50V [M]	C676	ECBT1H331KB5	330P 50V [M]	C901	ECA0JM102B	1000P 6.3V Δ [M]
C539	ECA1HPXS4R7B	4.7 50V [M]	C608	ECCR1H180KC5	18P 50V [M]	C677	ECBT1H331KB5	330P 50V [M]	C902	ECBT1H104ZF5	0.1 50V [M]
C547	ECBT1H391KB5	390P 50V [M]	C611	ECQV1H104JZ3	0.1 50V [M]	C691	ECA1EPXS470B	47 25V [M]	C903	ECBT1H104ZF5	0.1 50V [M]
C548	ECBT1H391KB5	390P 50V [M]	C612	ECQV1H104JZ3	0.1 50V [M]	C692	ECBT1C152KR5	1500P 16V [M]	C904	ECA0JM102B	1000P 6.3V Δ [M]
C549	ECBT1H471KB5	470P 50V [M]	C613	ECQV1H104JZ3	0.1 50V [M]	C693	ECCR1H180KC5	18P 50V [M]	C905	ECBT1E103ZF5	0.01 25V [M]
C550	ECBT1H471KB5	470P 50V [M]	C614	ECQV1H104JZ3	0.1 50V [M]	C694	ECQV1H104JZ3	0.1 50V [M]	C906	ECEA0JKA101B	100 6.3V [M]
C551	ECBT1H471KB5	470P 50V [M]	C615	ECBT1E103ZF5	0.01 25V [M]	C695	ECQV1H104JZ3	0.1 50V [M]	C907	ECEA0JKA101B	100 6.3V [M]
C552	ECBT1H471KB5	470P 50V [M]	C616	ECA1EM101B	100 25V [M]	C696	ECQE2334B117	0.33 250V [M]	C908	ECBT1E103ZF5	0.01 25V [M]
C559	ECBT1E103ZF5	0.01 25V [M]	C617	ECEA2AN2R2SB	2.2 100V [M]	C701	ECBT1E103ZF5	0.01 25V [M]	C909	ECEA1VKA220B	22 35V [M]
C560	ECBT1E103ZF5	0.01 25V [M]	C618	ECBT1H102KB5	1000P 50V [M]	C702	ECQE2104KF3	0.1 250V [M]	C910	ECEA1VKA220B	22 35V [M]
C561	ECA1EPXS100B	10 25V [M]	C619	ECA1EM101B	100 25V [M]	C703	ECES1JV103UX	0.01 63V Δ [M]	C911	ECEA1VKA220B	22 35V [M]
C562	ECA1EPXS100B	10 25V [M]	C621	ECEA2AU100B	10 100V [M]	C704	ECES1JV103UX	0.01 63V Δ [M]	C912	ECEA1VKA220B	22 35V [M]
C563	ECBT1E103ZF5	0.01 25V [M]	C622	ECEA2AU100B	10 100V [M]	C705	ECES1VV472NX	4700 35V Δ [M]	C913	ECEA1VKA100B	10 35V [M]
C564	ECBT1E103ZF5	0.01 25V [M]	C625	ECEA1HN100SB	10 50V [M]	C706	ECES1VV472NX	4700 35V Δ [M]	C914	ECEA1VKA100B	10 35V [M]
C565	ECBT1E103ZF5	0.01 25V [M]	C626	ECEA1HN100SB	10 50V [M]	C707	ECA1VM101B	100 35V [M]	C916	ECEA1HKA010B	1 50V [M]
C566	ECBT1E103ZF5	0.01 25V [M]	C631	ECQB1H223JM3	0.022 50V [M]	C708	ECKR1H103ZF5	0.01 50V [M]	C917	ECEA0JKA101B	100 6.3V [M]
C567	ECBT1E103ZF5	0.01 25V [M]	C632	ECQB1H223JM3	0.022 50V [M]	C709	ECEA1CKA330B	33 16V [M]	C918	ECEA0JKA101B	100 6.3V [M]
C568	ECBT1E103ZF5	0.01 25V [M]	C633	ECQB1H223JM3	0.022 50V [M]	C710	ECBT1E103ZF5	0.01 25V [M]	C920	ECEA1HKA010B	1 50V [M]
C569	ECA1EPXS100B	10 25V [M]	C634	ECQB1H223JM3	0.022 50V [M]	C711	ECKR1H103ZF5	0.01 50V [M]	C932	ECBT1H101KB5	100P 50V [M]
C570	ECA1EPXS100B	10 25V [M]	C635	ECQB1H223JM3	0.022 50V [M]	C712	ECEA1HKA100B	10 50V [M]	C933	ECBT1H101KB5	100P 50V [M]
C572	ECBT1H101KB5	100P 50V [M]	C636	ECQB1H223JM3	0.022 50V [M]	C713	ECKR1H103ZF5	0.01 50V [M]	C935	ECBT1H101KB5	100P 50V [M]
C573	ECBT1C392KR5	3900P 16V [M]	C637	ECQB1H223JM3	0.022 50V [M]	C714	ECA1EPXS470B	47 25V [M]	C936	ECBT1H101KB5	100P 50V [M]
C574	ECBT1E103ZF5	0.01 25V [M]	C638	ECQB1H223JM3	0.022 50V [M]	C715	ECEA1CKA101B	100 16V [M]	C937	ECBT1H101KB5	100P 50V [M]
C575	ECBT1E103ZF5	0.01 25V [M]	C641	ECA1EPXS470B	47 25V [M]	C716	ECQE2104KF3	0.1 250V [M]	C943	ECBT1H331KB5	330P 50V [M]
C576	ECBT1H104ZF5	0.1 50V [M]	C642	ECBT1H821KB5	820P 50V [M]	C721	ECQE2104KF3	0.1 250V [M]	C944	ECEA1CKA100B	10 16V [M]
C577	ECA1HPXS4R7B	4.7 50V [M]	C643	ECCR1H180KC5	18P 50V [M]	C751	ECKWRS102MBC	1000P 400V Δ [M]	C945	ECBT1E103ZF5	0.01 25V [M]
C578	ECA1HPXS4R7B	4.7 50V [M]	C644	ECQV1H104JZ3	0.1 50V [M]	C752	ECKR1H103ZF5	0.01 50V [M]	C946	ECBT1H470J5	47P 50V [M]
C579	ECBT1H221KB5	220P 50V [M]	C645	ECQV1H104JZ3	0.1 50V [M]	C753	ECA1EM102E	1000 25V Δ [M]	C947	ECBT1H470J5	47P 50V [M]
C580	ECBT1H221KB5	220P 50V [M]	C646	ECQE2334B117	0.33 250V [M]	C754	ECBT1E103ZF5	0.01 25V [M]	C956	ECBT1H101KB5	100P 50V [M]
C581	ECBT1H331KB5	330P 50V [M]	C651	ECA1EPXS470B	47 25V [M]	C755	ECEA1CU470B	47 16V [M]	C959	ECBT1H104ZF5	0.1 50V [M]
C582	ECBT1H331KB5	330P 50V [M]	C652	ECA1EPXS470B	47 25V [M]	C757	ECEA1CKA100B	10 16V [M]	C960	ECBT1H104ZF5	0.1 50V [M]
C583	ECBT1E103ZF5	0.01 25V [M]	C653	ECBT1H821KB5	820P 50V [M]	C758	ECEA1AKA101B	100 10V [M]	C962	ECBT1H561KB5	560P 50V [M]
C584	ECBT1E103ZF5	0.01 25V [M]	C654	ECBT1H821KB5	820P 50V [M]	C759	ECA1CM471B	470 16V [M]	C963	ECBT1H102KB5	1000P 50V [M]
C585	ECA1EPXS100B	10 25V [M]	C657	ECCR1H180KC5	18P 50V [M]	C771	ECEA1HKA4R7B	4.7 50V [M]	C984	ECBT1H101KB5	100P 50V [M]
C586	ECA1EPXS100B	10 25V [M]	C658	ECCR1H180KC5	18P 50V [M]	C772	ECEA1HKA4R7B	4.7 50V [M]	C985	ECBT1H101KB5	100P 50V [M]
C587	ECA1EPXS100B	10 25V [M]	C661	ECQV1H104JZ3	0.1 50V [M]	C773	ECBT1E223ZF5	0.022 25V [M]	C991	ECBT1H101KB5	100P 50V [M]
C588	ECA1EPXS100B	10 25V [M]	C662	ECQV1H104JZ3	0.1 50V [M]	C774	ECEA0JKA101B	100 6.3V [M]	C992	ECBT1H101KB5	100P 50V [M]
C589	ECA1EPXS470B	47 25V [M]	C663	ECQV1H104JZ3	0.1 50V [M]	C775	ECEA1CKA100B	10 16V [M]	C993	ECBT1H331KB5	330P 50V [M]
C590	ECA1EPXS470B	47 25V [M]	C664	ECQV1H104JZ3	0.1 50V [M]	C776	ECEA1HKA010B	1 50V [M]	C996	ECA1EPXS100B	10 25V [M]
C591	ECA1EPXS470B	47 25V [M]	C665	ECBT1E103ZF5	0.01 25V [M]	C801	ECA1EPXS470B	47 25V [M]	C997	ECEA1CKA100B	10 16V [M]
C592	ECA1EPXS470B	47 25V [M]	C666	ECA1EM101B	100 25V [M]	C802	ECBT1H821KB5	820P 50V [M]	C998	ECBT1E103ZF5	0.01 25V [M]
C593	ECBT1H104ZF5	0.1 50V [M]	C667	ECEA2AN2R2SB	2.2 100V [M]	C803	ECBT1E103ZF5	0.01 25V [M]	C1001	ECEA1HKA010B	1 50V [M]
C594	ECBT1H104ZF5	0.1 50V [M]	C668	ECBT1H102KB5	1000P 50V [M]	C804	ECBT1E103ZF5	0.01 25V [M]	C1002	ECEA1HKA010B	1 50V [M]
C595	ECBT1H102KB5	1000P 50V [M]	C669	ECA1EM101B	100 25V [M]	C805	ECA1EPXS100B	10 25V [M]	C1003	ECEA1HKA3R3B	3.3 50V [M]
C596	ECBT1H102KB5	1000P 50V [M]	C671	ECEA2AU100B	10 100V [M]	C806	ECA1EPXS100B	10 25V [M]	C1004	ECEA1HKA3R3B	3.3 50V [M]
C601	ECA1EPXS470B	47 25V [M]	C672	ECEA2AU100B	10 100V [M]	C807	ECA1EPXS100B	10 25V [M]	C1005	ECEA1HKA010B	1 50V [M]
C602	ECA1EPXS470B	47 25V [M]	C673	ECBT1H102KB5	1000P 50V [M]	C891	ECBT1H102KB5	1000P 50V [M]	C1007	ECFR1E223KR	0.022 25V [M]
C603	ECBT1H821KB5	820P 50V [M]	C674	ECBT1H102KB5	1000P 50V [M]	C892	ECBT1H102KB5	1000P 50V [M]	C1008	ECFR1E473KR	0.047 25V [M]
C604	ECBT1H821KB5	820P 50V [M]	C675	ECBT1H102KB5	1000P 50V [M]	C893	ECEA1CKA100B	10 16V [M]	C1009	ECEA0JU221B	220 6.3V [M]

Ref. No.	Part No.	Values & Remarks	Part No.	Values & Remarks	Ref. No.	Part No.	Values & Remarks	Ref. No.	Part No.	Values & Remarks
C1010	ECEA1CKA100B	10 16V [M]	C1068	ECBT1C152KR5 1500P 16V [M]						
C1011	ECEA1CKA100B	10 16V [M]	C1151	ECEA1HKA010B 1 50V [M]						
C1012	ECEA1CKA100B	10 16V [M]	C1152	ECFR1E823KR 0.082 25V [M]						
C1013	ECEA1CKA100B	10 16V [M]	C1153	ECFR1E393KR 0.039 25V [M]						
C1014	ECEA0JU221B	220 6.3V [M]	C1154	ECEA1VKA4R7B 4.7 35V [M]						
C1015	ECQV1H104JM3	0.1 50V [M]	C1156	ECBT1E103ZF5 0.01 25V [M]						
C1016	ECQV1H104JM3	0.1 50V [M]	C1157	ECBT1E103ZF5 0.01 25V [M]						
C1017	ECEA1HKAR47B	0.47 50V [M]	C1159	ECEA1HKA010B 1 50V [M]						
C1018	ECEA1HKA4R7B	4.7 50V [M]	C1161	ECBT1H101KB5 100P 50V [M]						
C1019	ECEA1HKAR47B	0.47 50V [M]	C1683	ECBT1C332KR5 3300P 16V [M]						
C1020	ECEA1HKA4R7B	4.7 50V [M]	C1684	ECBT1C332KR5 3300P 16V [M]						
C1021	ECEA1HKAR15B	0.15 50V [M]	C1685	ECBT1E103ZF5 0.01 25V [M]						
C1022	ECEA1HKA3R3B	3.3 50V [M]								
C1023	ECQV1H154JM3	0.15 50V [M]								
C1024	ECQV1H154JM3	0.15 50V [M]								
C1025	ECEA1HKA3R3B	3.3 50V [M]								
C1026	ECEA1HKAR15B	0.15 50V [M]								
C1027	ECEA1HKA4R7B	4.7 50V [M]								
C1028	ECEA1HKAR47B	0.47 50V [M]								
C1029	ECEA1HKA4R7B	4.7 50V [M]								
C1030	ECEA1HKAR47B	0.47 50V [M]								
C1031	ECQV1H104JM3	0.1 50V [M]								
C1032	ECQV1H104JM3	0.1 50V [M]								
C1033	ECEA0JKA470B	47 6.3V [M]								
C1034	ECQV1H474JM3	0.47 50V [M]								
C1035	ECBT1H681KB5	680P 50V [M]								
C1036	ECBT1H101KB5	100P 50V [M]								
C1037	ECBT1H101KB5	100P 50V [M]								
C1038	ECBT1H101KB5	100P 50V [M]								
C1039	ECEA1CKA101B	100 16V [M]								
C1040	ECEA1CKA100B	10 16V [M]								
C1041	ECBT1E103ZF5	0.01 25V [M]								
C1043	ECA1EPXS100B	10 25V [M]								
C1044	ECA1EPXS100B	10 25V [M]								
C1051	ECEA1HKA2R2B	2.2 50V [M]								
C1052	ECEA1HKAR33B	0.33 50V [M]								
C1053	ECEA1HKA3R3B	3.3 50V [M]								
C1054	ECEA0JU221B	220 6.3V [M]								
C1055	ECEA1HKAR47B	0.47 50V [M]								
C1056	ECFR1E823KR	0.082 25V [M]								
C1057	ECFR1E332KR	3300P 25V [M]								
C1058	ECFR1E823KR	0.082 25V [M]								
C1059	ECEA1CKA101B	100 16V [M]								
C1060	ECBT1E223ZF5	0.022 25V [M]								
C1062	ECBT1E223ZF5	0.022 25V [M]								
C1063	ECEA1CKA101B	100 16V [M]								
C1064	ECEA1HKA010B	1 50V [M]								
C1065	ECBT1H681KB5	680P 50V [M]								
C1067	ECBT1C152KR5	1500P 16V [M]								

■ Packing Materials & Accessories

Notes: * Important safety notice:

Components identified by \triangle mark have special characteristics important for safety.

Furthermore, special parts which have purposes of fire-retardant (resistors), high-quality sound (capacitors), low noise (resistors), etc are used. When replacing any of these components, be sure to use only manufacturer's specified parts shown in the parts list.

* The parenthesized indications in the Remarks columns specify the areas. (Refer to the cover page for area)
Parts without these indications can be used for all areas.

* [M] indicates in the Remarks columns indicates parts supplied by MESA.

* Remote Control Unit : Supply period for three years from terminal of production.

* Reference for O/I book languages are as follows :

Ar : Arabic	Cf : Canadian French	Co : Chinese (old)	Cn : Chinese (new)	Cz : Czech	Da : Danish
Du : Dutch	En : English	Fr : French	Ge : German	It : Italian	Ko : Korean
Po : Polish	Ru : Russian	Sp : Spanish	Sw : Swedish		

Ref No.	Part No.	Part Name & Description	Remarks	Ref No.	Part No.	Part Name & Description	Remarks	Ref No.	Part No.	Part Name & Description	Remarks
		PACKING MATERIALS		A2	RJA0019-2K	AC CORD (SF) \triangle	[M]EG E	A3	RQT5030-R	O/I BOOK (Ru/Cz/Po)	[M]E
P1	RPG4485	PACKING CASE	[M]	A2	VJA0733	AC CORD (SF) \triangle	[M]EB	A3	RQT5031-D	O/I BOOK (Ge/It/Fr)	[M]EG
P2	RPN1129	POLYFORM	[M]	A3	RQT4904-E	O/I R/C (En/Sp/Sw)	[M]E	A3	RQT5032-H	O/I BOOK (Du/Da)	[M]EG
P3	RPFX0005	MIRAMAT BAG	[M]	A3	RQT4905-R	O/I R/C (Ru/Cz/Po)	[M]E	A3	RQT5033-B	O/I BOOK (En)	[M]EB
		ACCESSORIES		A3	RQT4906-D	O/I R/C (Ge/It/Fr)	[M]EG	A4	RSA0007	FM ANTENNA	[M]
A1	EUR646497	REMOTE CONTROL	[M]	A3	RQT4907-H	O/I R/C (Du/Da)	[M]EG	A5	RSA0010	LOOP ANT UNIT	[M]
A1-1	UR64EC1987B	R/C BATTERY COVER	[M]	A3	RQT4908-B	O/I R/C (En)	[M]EB	A6	SJP9009	ANT ADAPTER	[M]EB
				A3	RQT5029-E	O/I BOOK (En/Sp/Sw)	[M]E				

■ Packaging

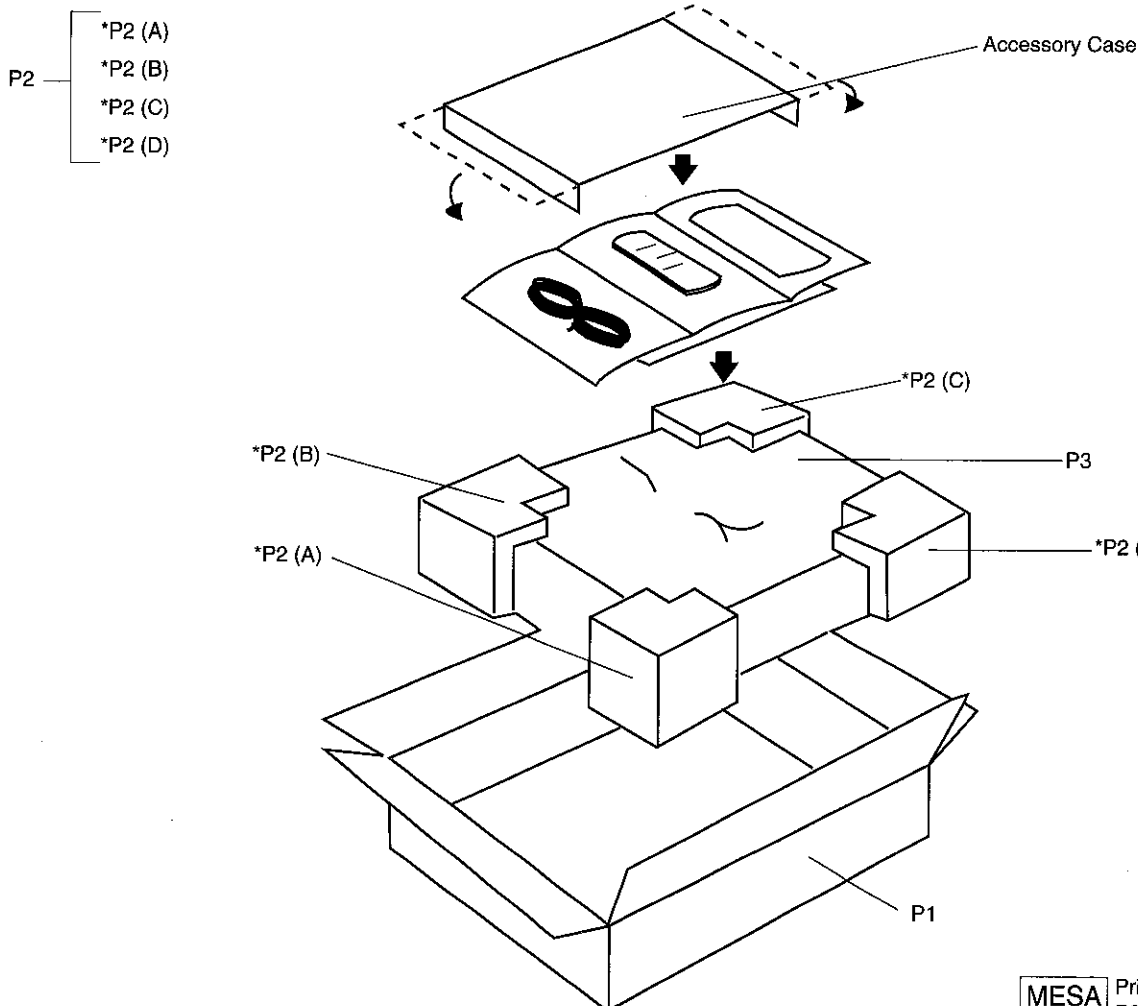

Door No. 3		Drop No. 0	
K83N			
Customer: TECHNICA42			
Load: SPOWE1			
Mesa1 : MDRR0711ZC2			Qty: 1