

**A** TUNER CIRCUIT For [E,EB] areas. (P.C.Board: on page 42)

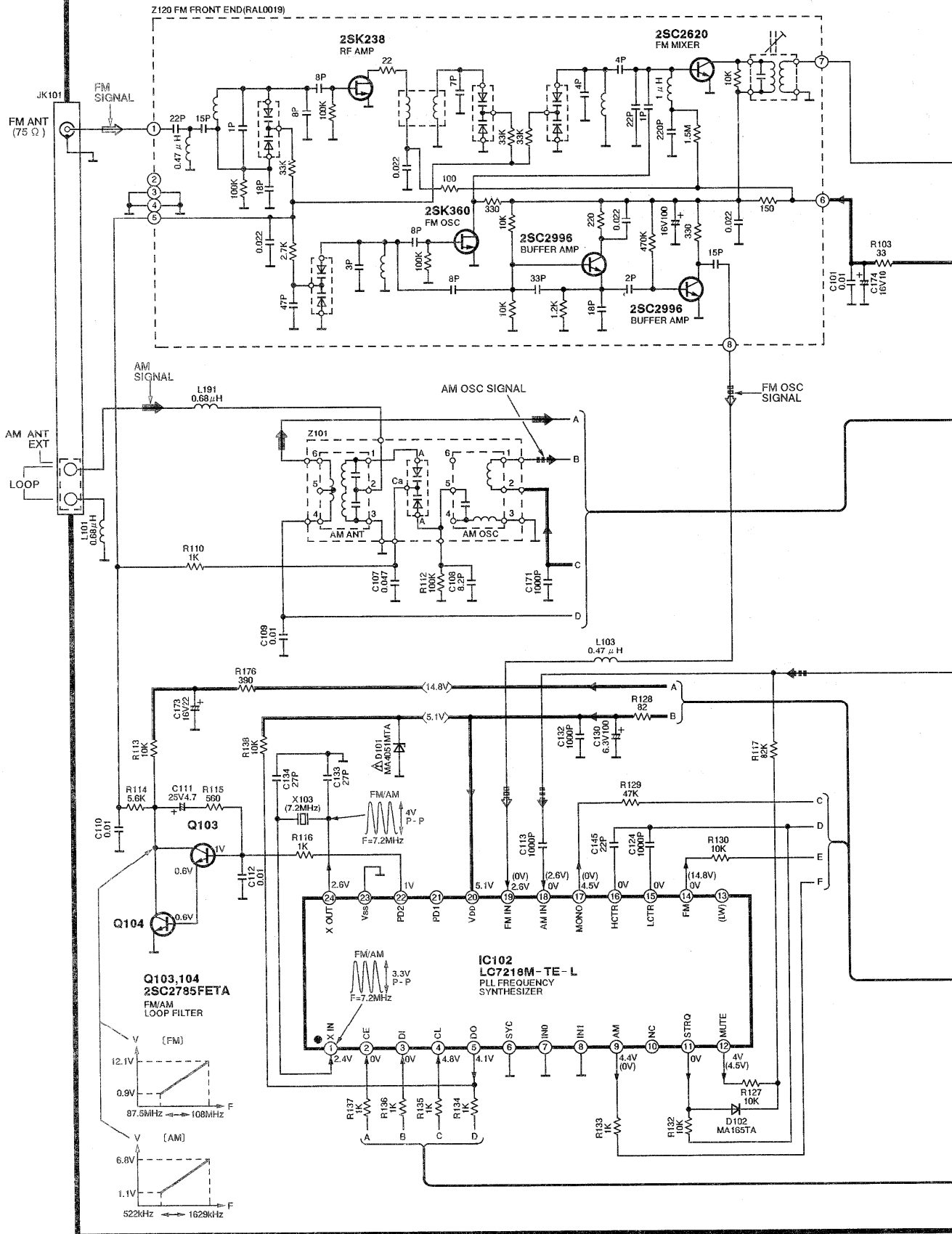

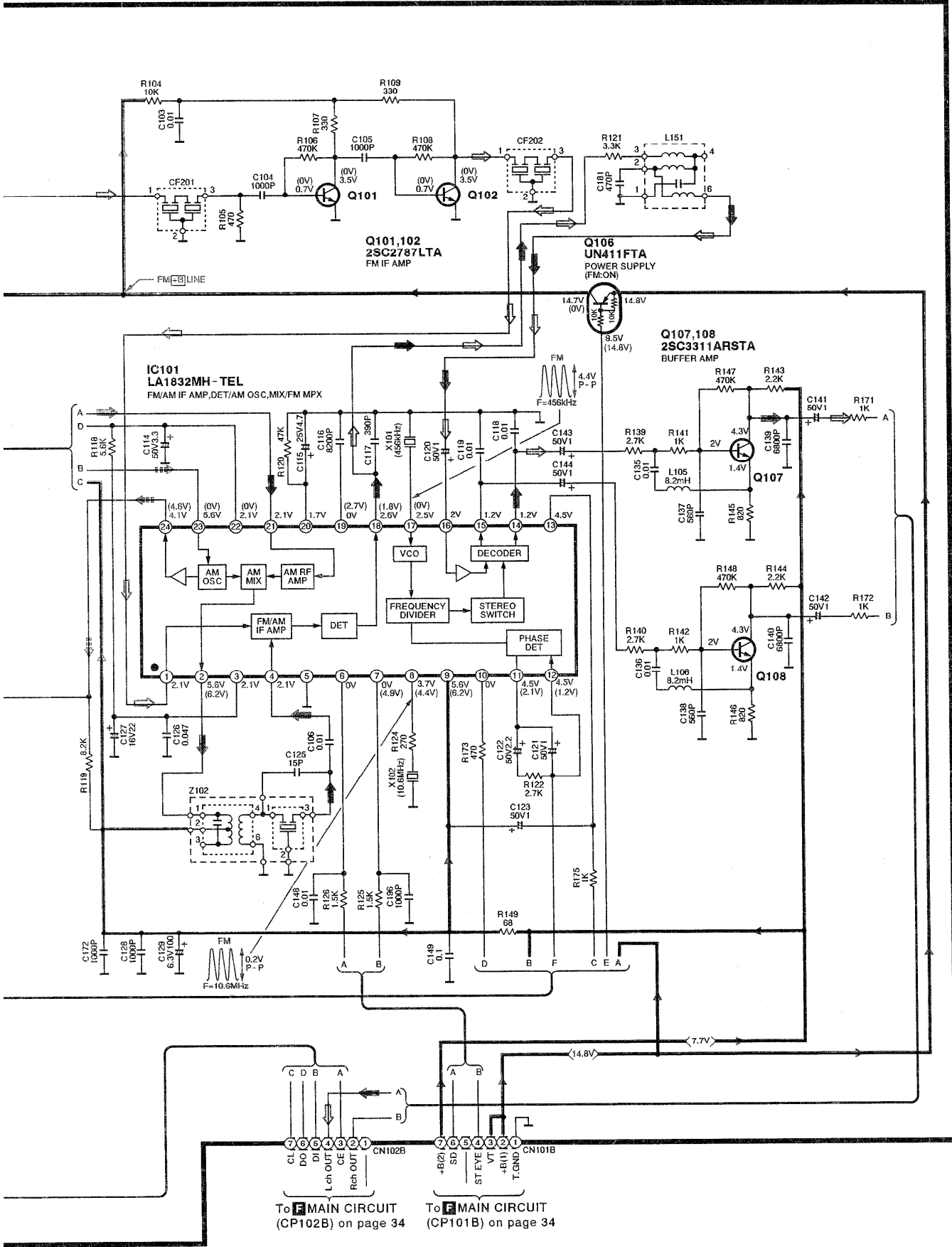

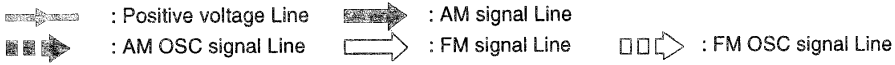

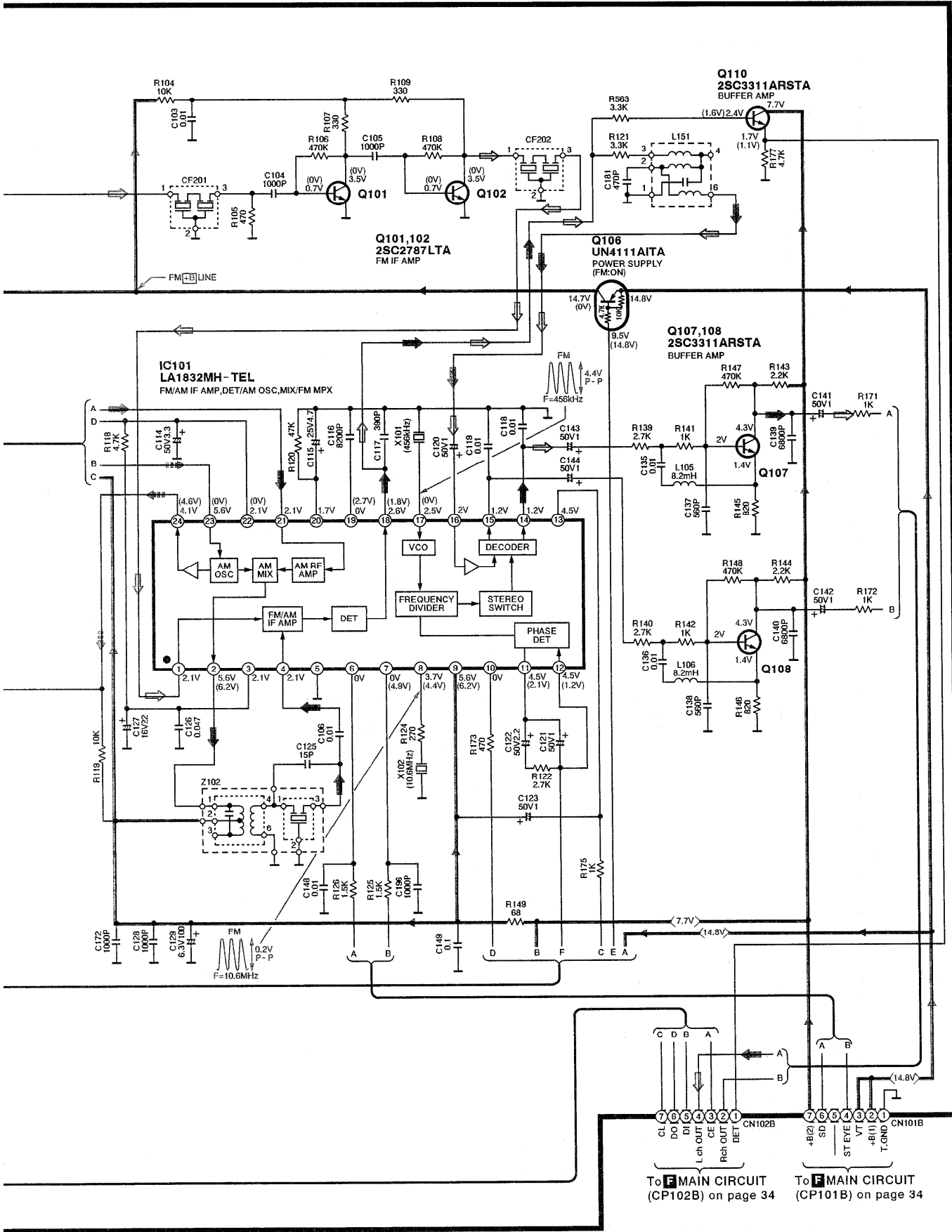
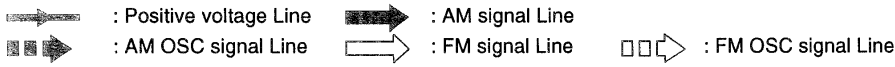

To MAIN CIRCUIT (CP102B) on page 34  
 To MAIN CIRCUIT (CP101B) on page 34

**A TUNER CIRCUIT** For [GC,GN] areas. (P.C.Board on page 43)

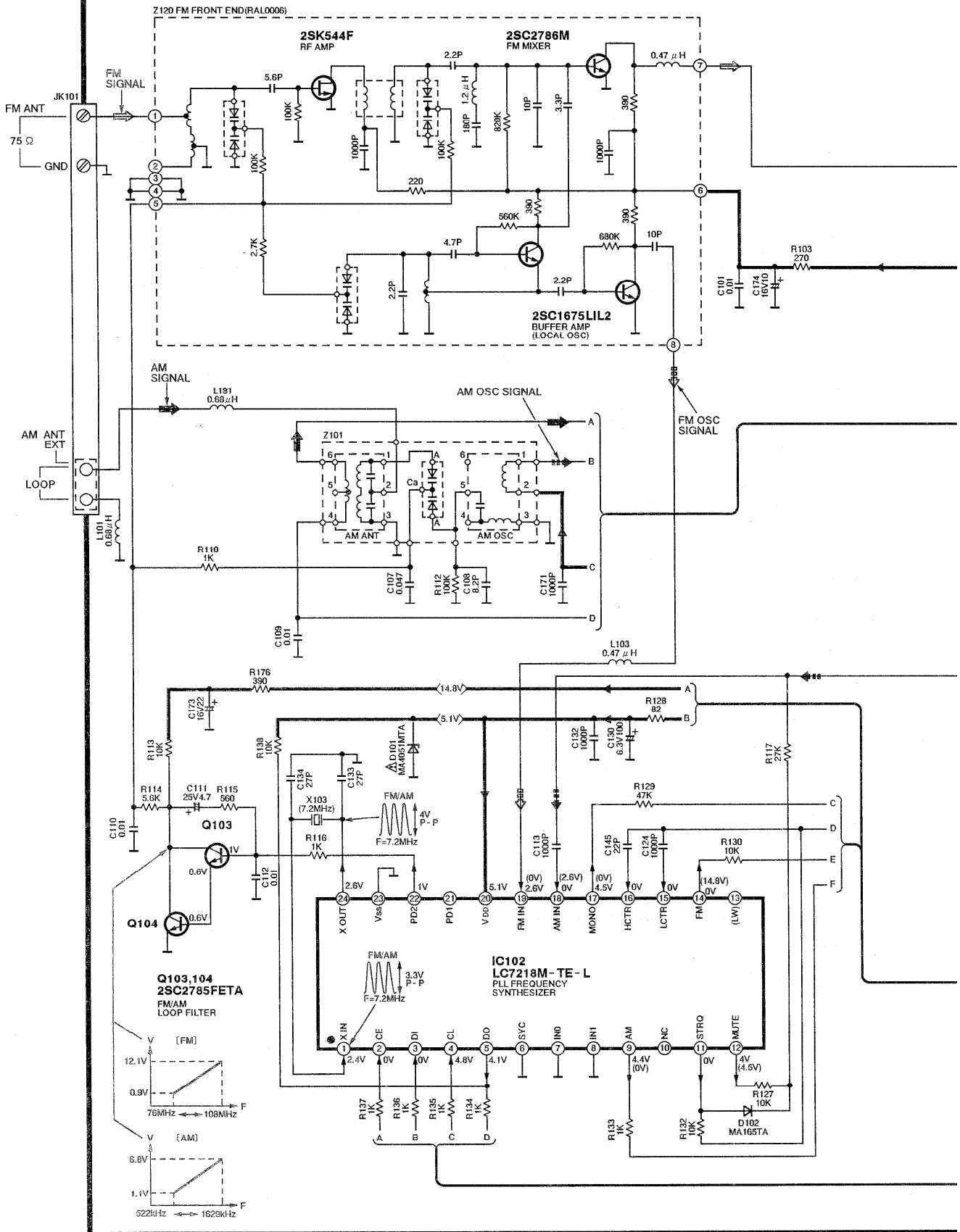

- : Positive voltage Line
- : AM signal Line
- : AM OSC signal Line
- : FM signal Line
- : FM OSC signal Line

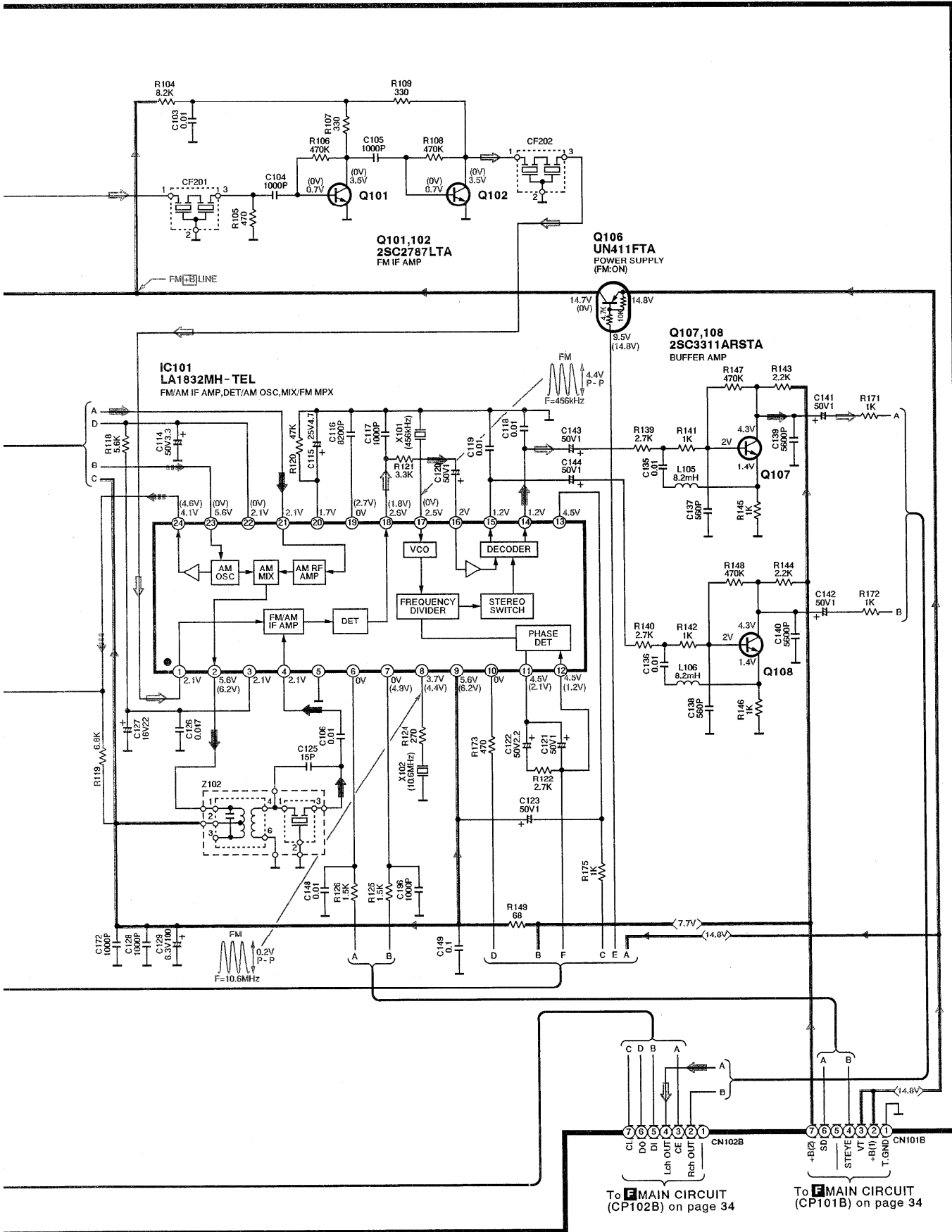

**B** OPERATION CIRCUIT (P.C.Board: on page 43)

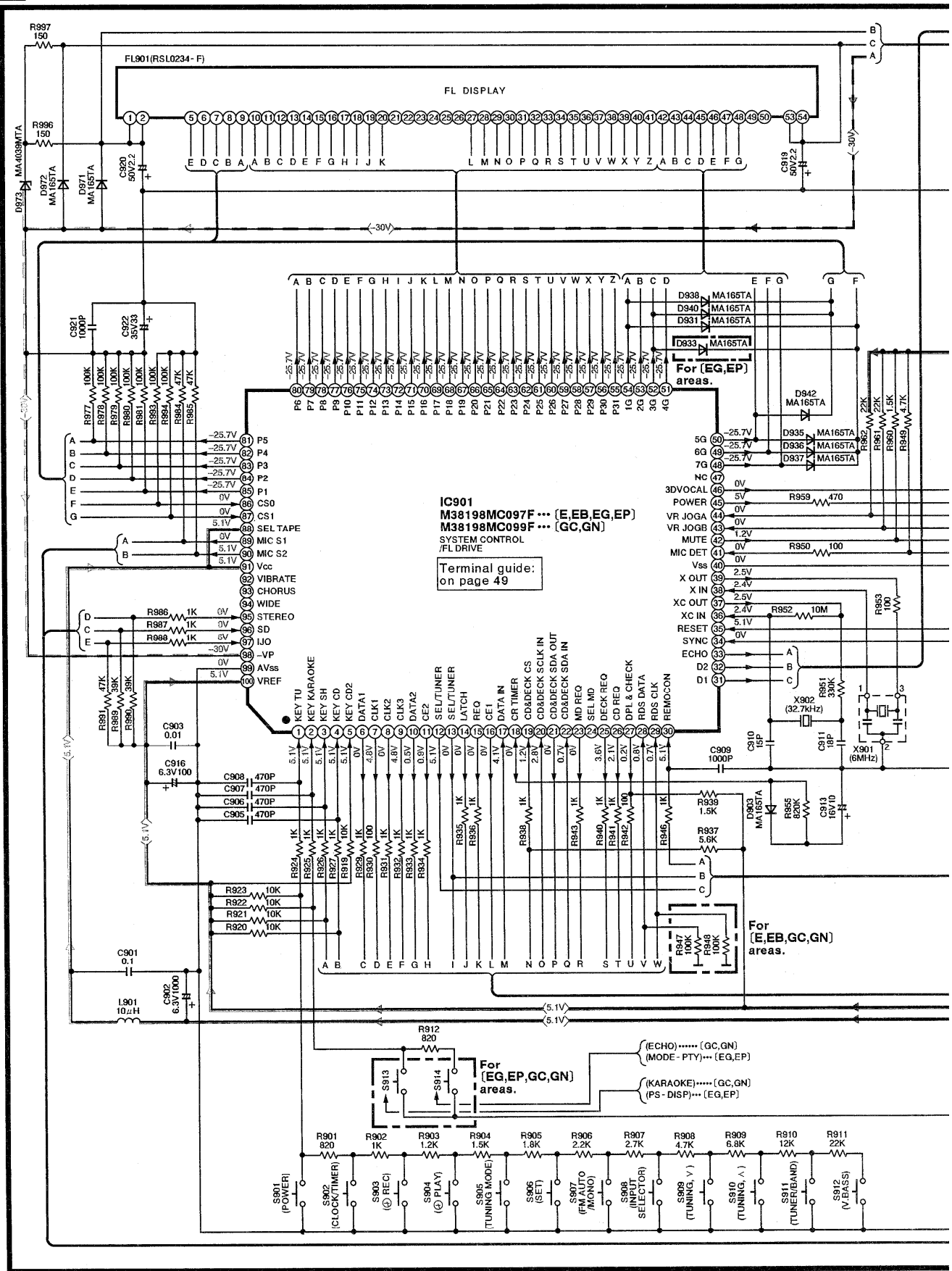

**IC901**  
**M38198MC097F ... [E,EB,EG,EP]**  
**M38198MC099F ... [GC,GN]**  
 SYSTEM CONTROL  
 /FL DRIVE

Terminal guide:  
 on page 49

For (EG,EP) areas.

For (E,EB,GC,GN) areas.

For (E,EB,GC,GN) areas.  
 (ECHO)..... [GC,GN]  
 (MODE - PTY).... [EG,EP]  
 (KARAOKE)..... [GC,GN]  
 (PS - DISP).... [EG,EP]

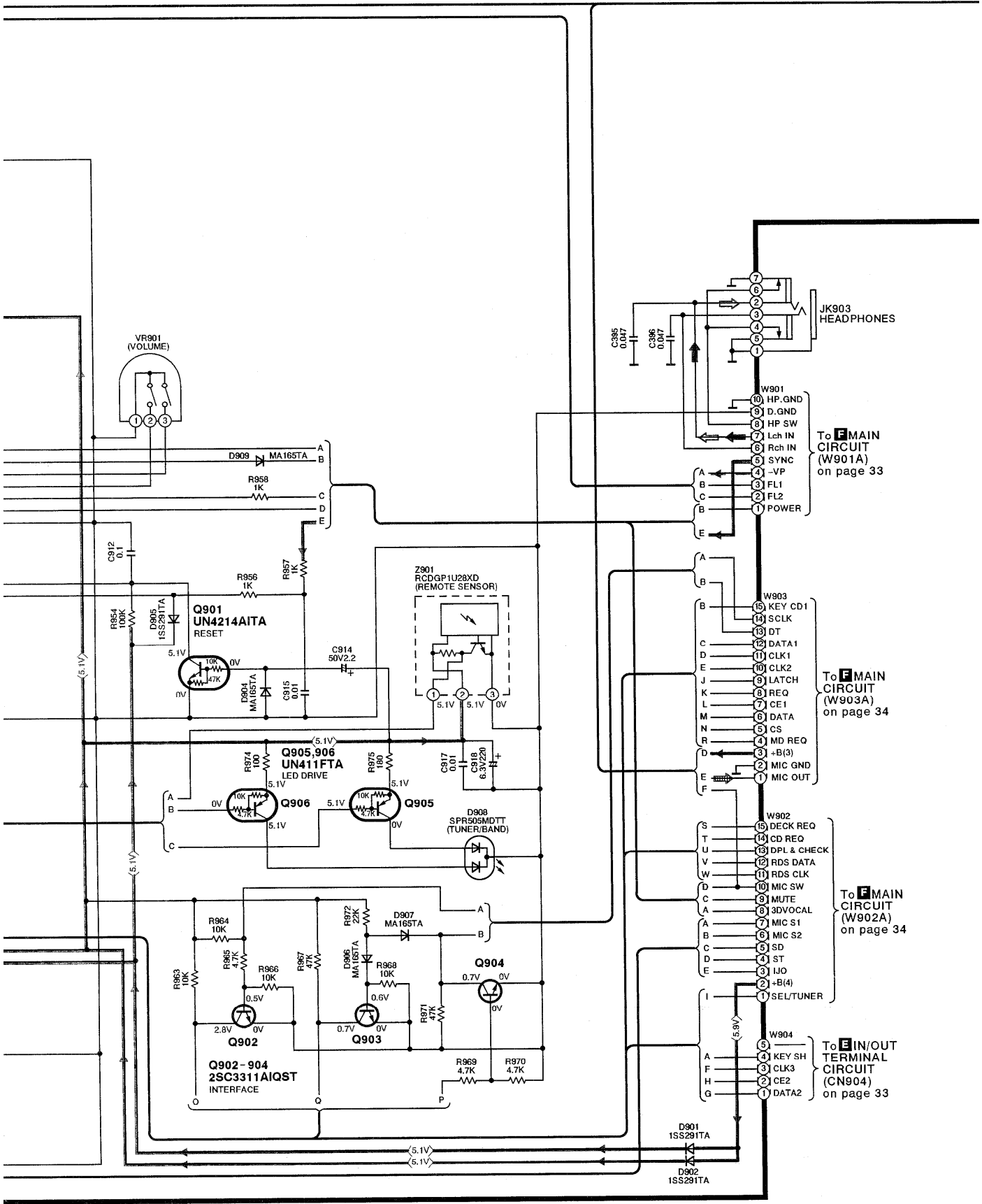
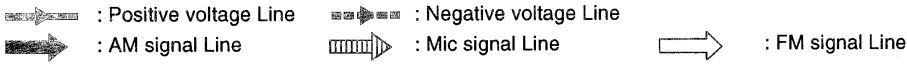

To MAIN CIRCUIT (W901A) on page 33

To MAIN CIRCUIT (W903A) on page 34

To MAIN CIRCUIT (W902A) on page 34

To IN/OUT TERMINAL CIRCUIT (CN904) on page 33



**B** OPERATION CIRCUIT (P.C.Board: on page 43)

**C** MIC JACK CIRCUIT (P.C.Board: on page 44)

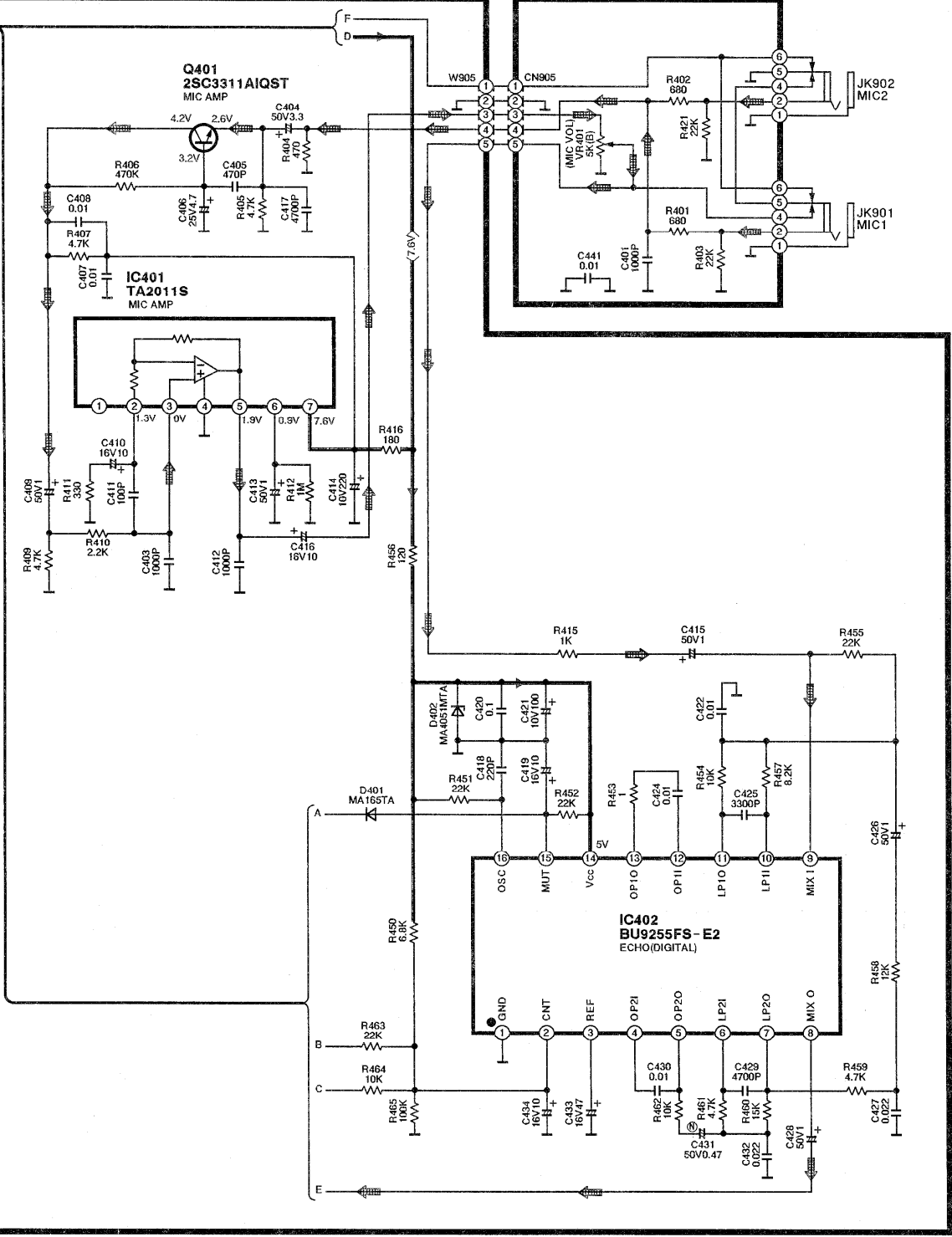

For [GC,GN] areas.

- : Positive voltage Line
- : Negative voltage Line
- : Surround Speaker signal Line
- : AM signal Line
- : FM signal Line
- : Mic signal Line
- : Center Speaker Drive signal Line

**D** DOLBY PROLOGIC CIRCUIT (P.C.Board: on page 44)

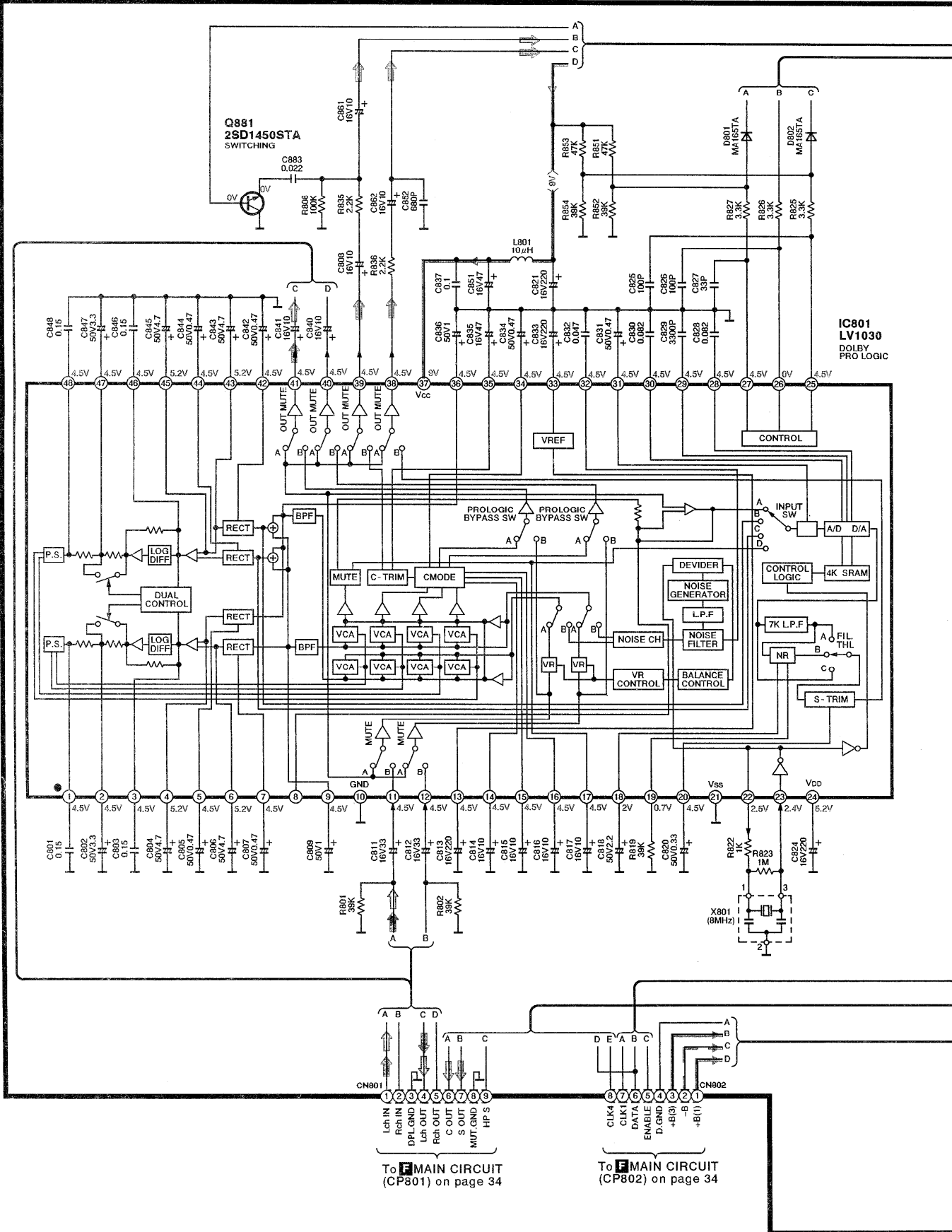

To MAIN CIRCUIT (CP801) on page 34

To MAIN CIRCUIT (CP802) on page 34

**D** DOLBY PROLOGIC CIRCUIT (P.C.Board: on page 44)

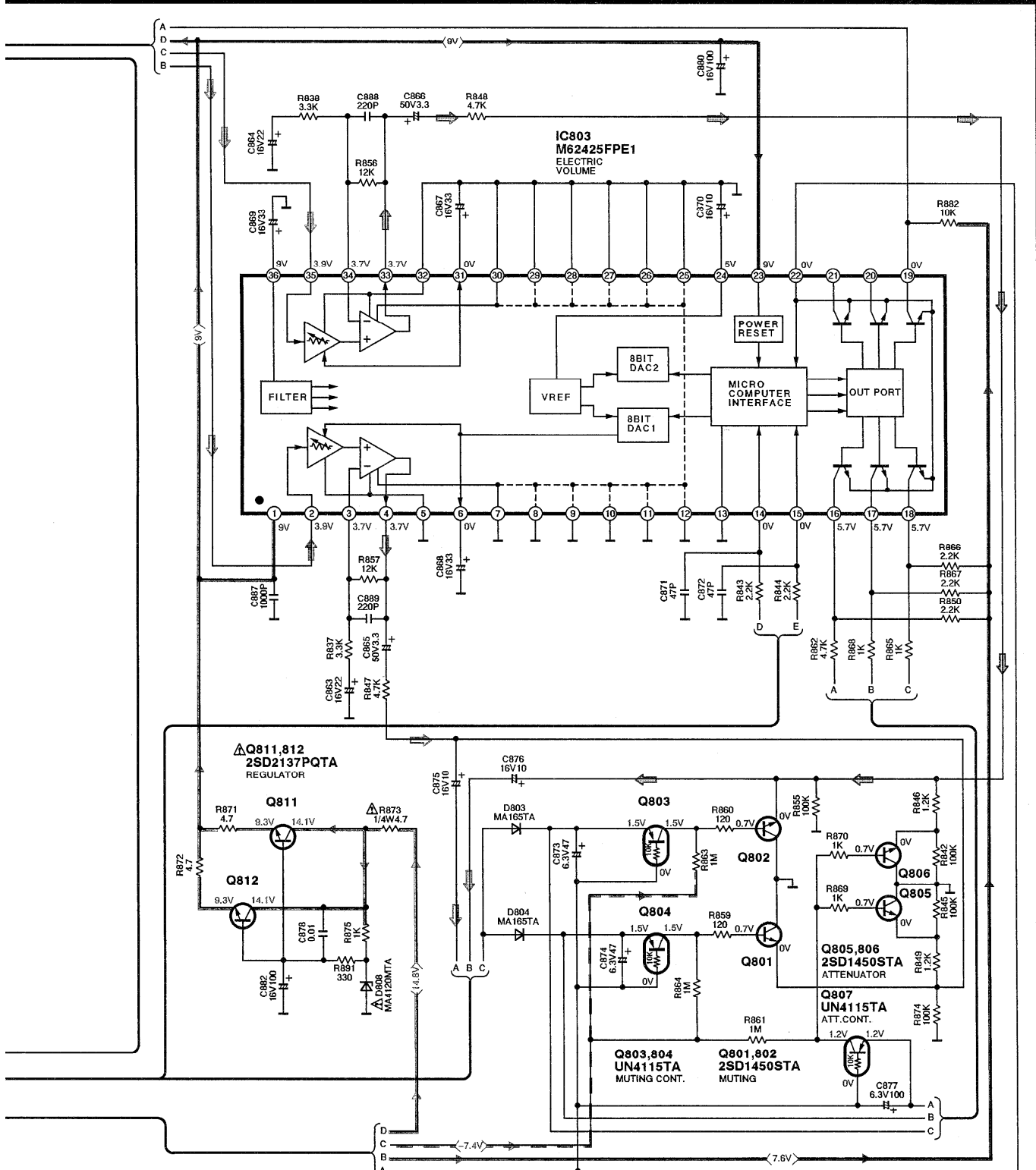

**E** IN/OUT TERMINAL CIRCUIT (P.C.Board: on page 44)

**F** MAIN CIRCUIT (P.C.Board: on pages 44,45)

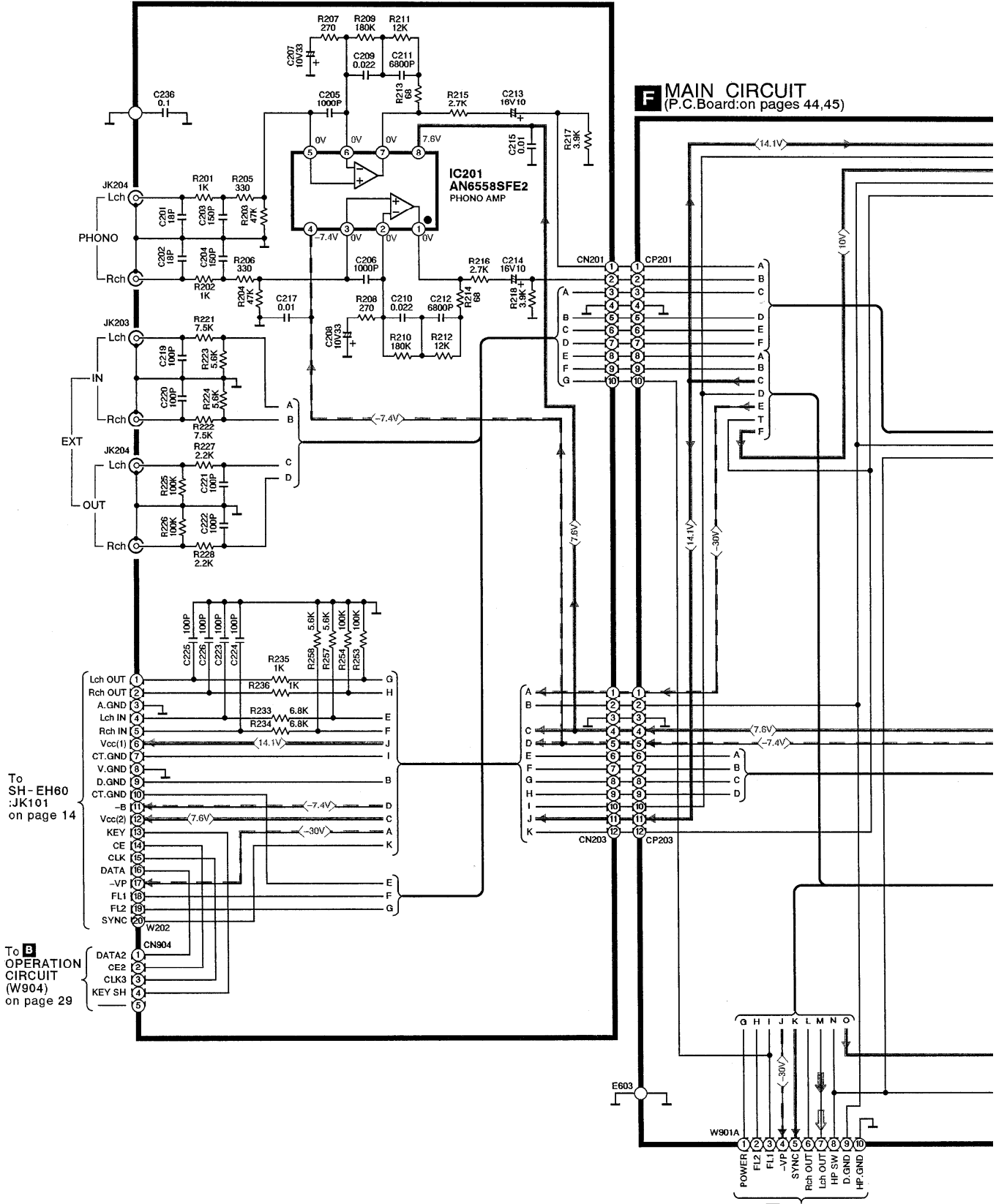

To SH-EH60 :JK101 on page 14

To OPERATION CIRCUIT (W904) on page 29

To OPERATION CIRCUIT (W901) on page 29

- : Positive voltage Line
- : Negative voltage Line
- : Surround Speaker signal Line
- : AM signal Line
- : FM signal Line
- : Mic signal Line
- : Center Speaker Drive signal Line

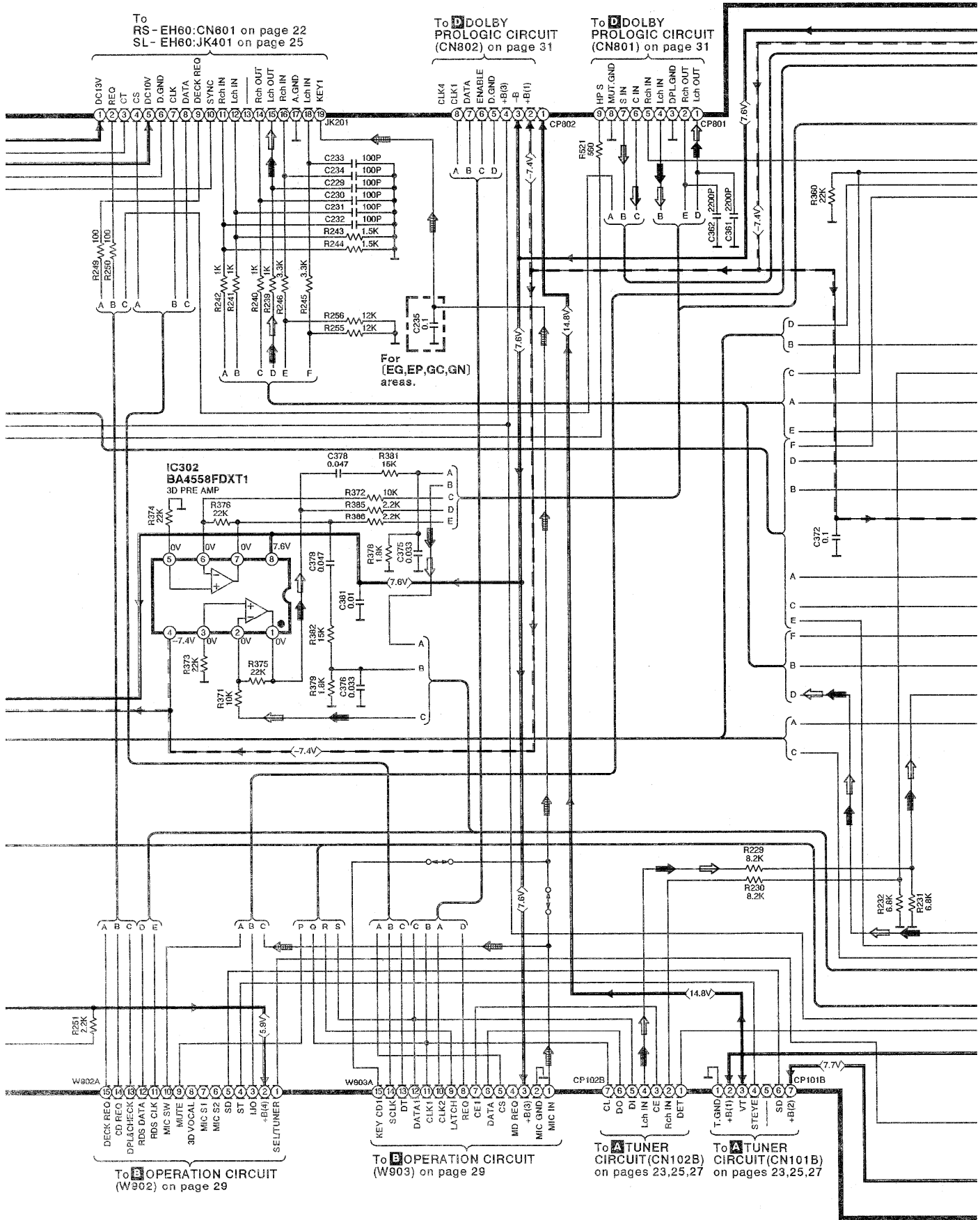
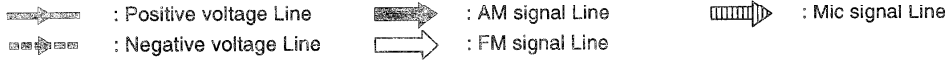

**F** MAIN CIRCUIT (P.C.Board: on pages 44,45)

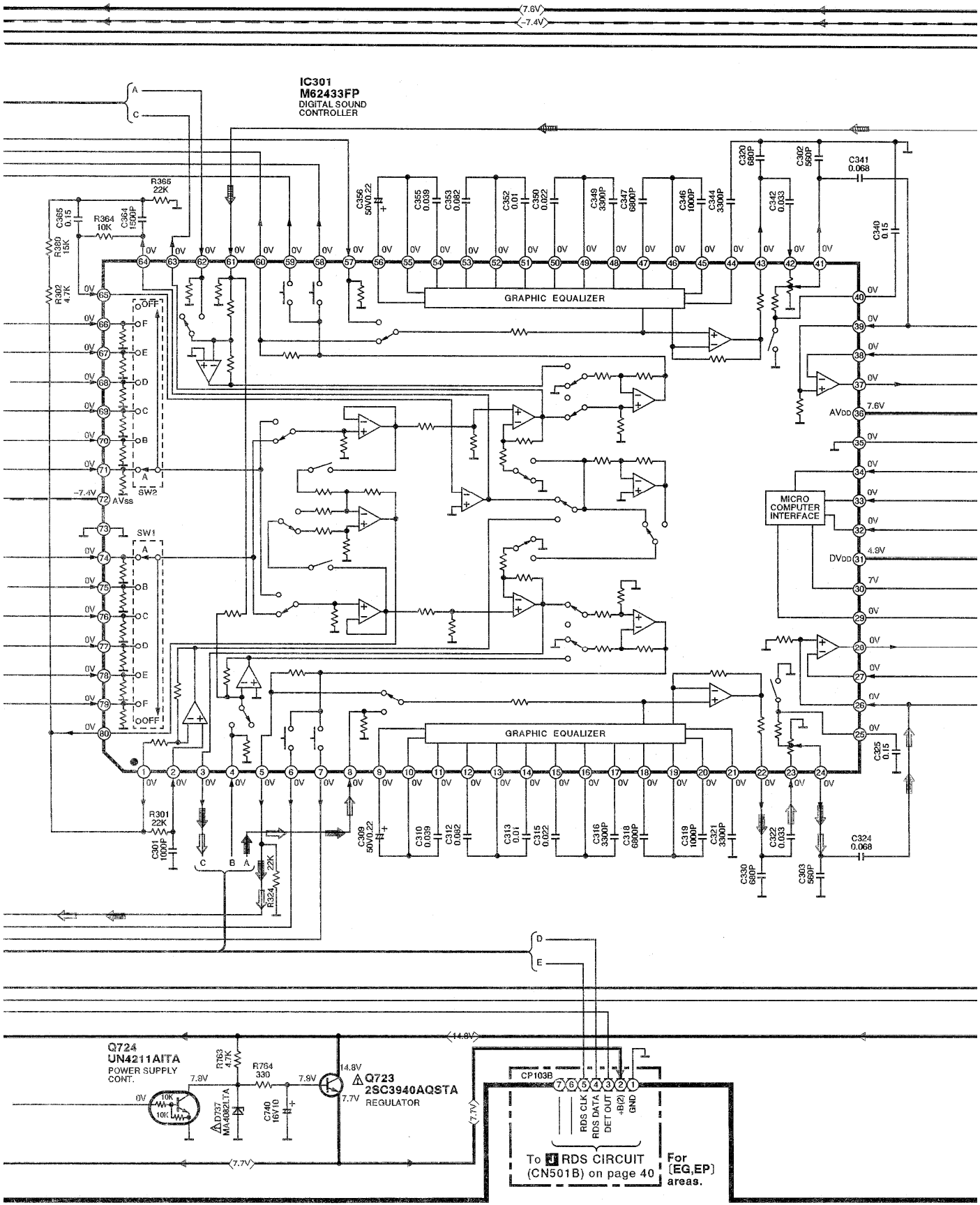

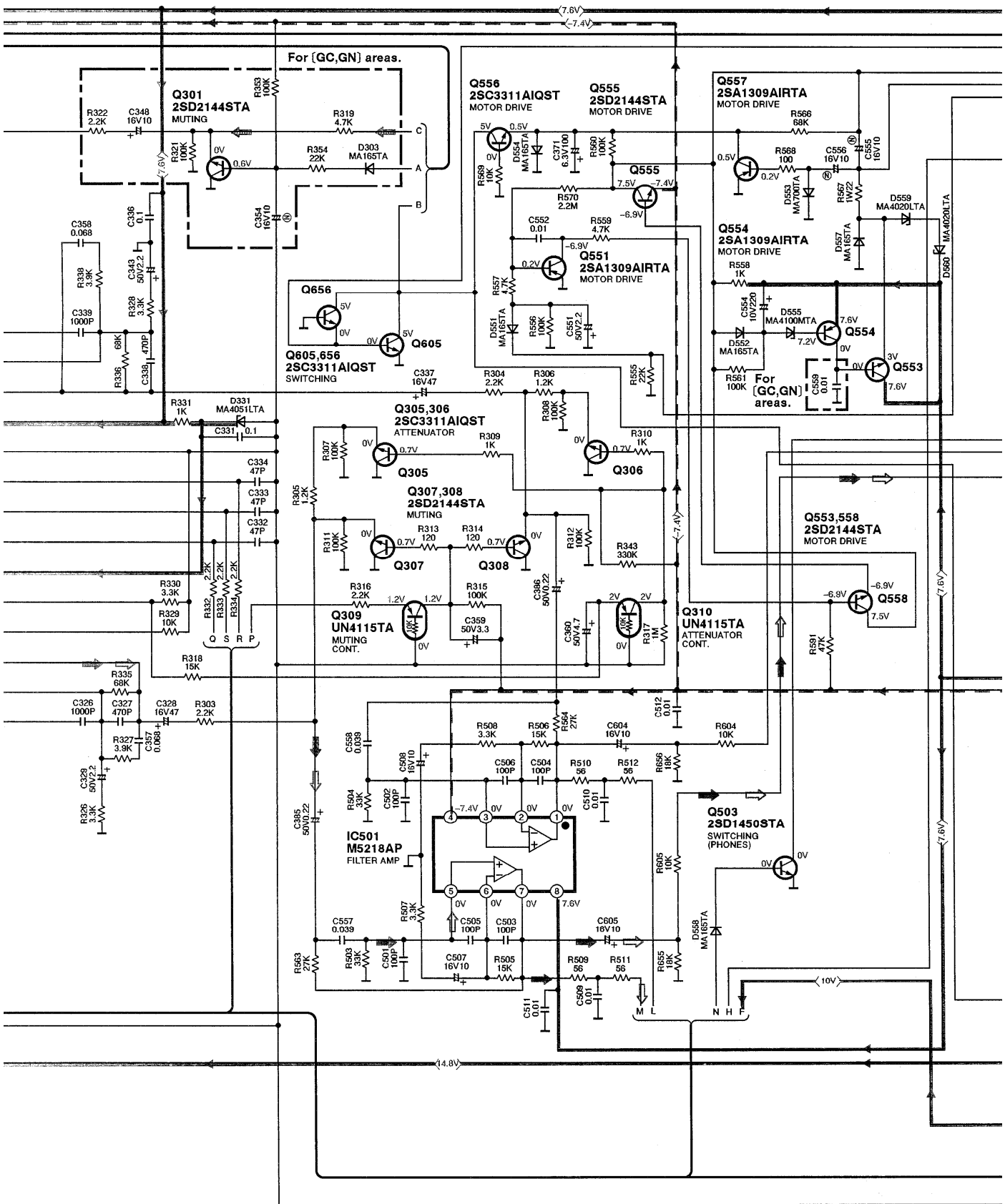
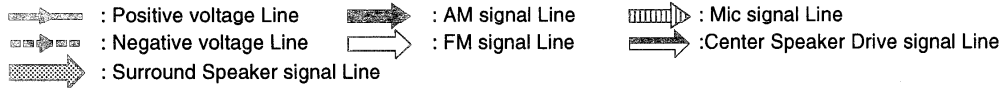

**F** MAIN CIRCUIT (P.C.Board: on pages 44,45)

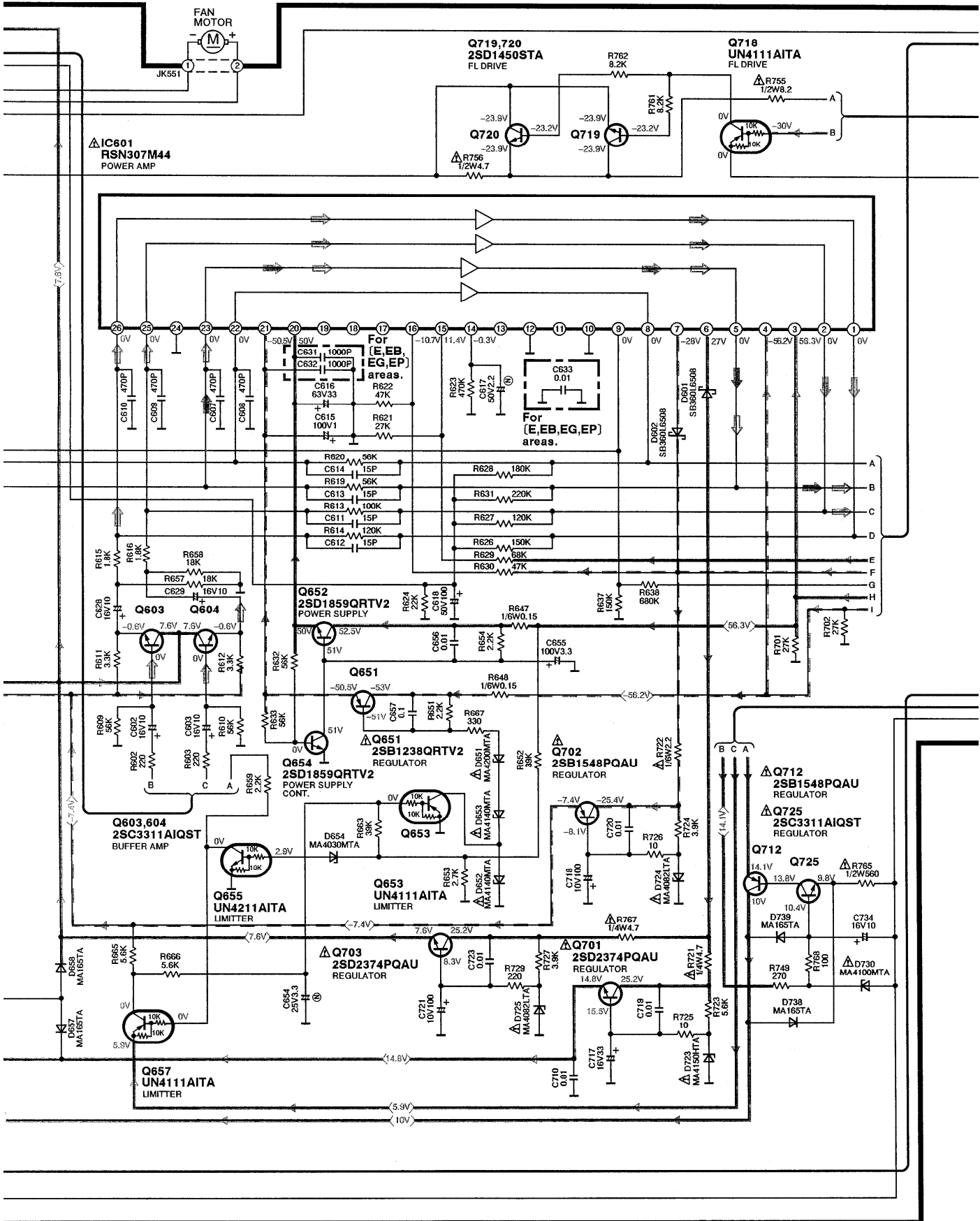



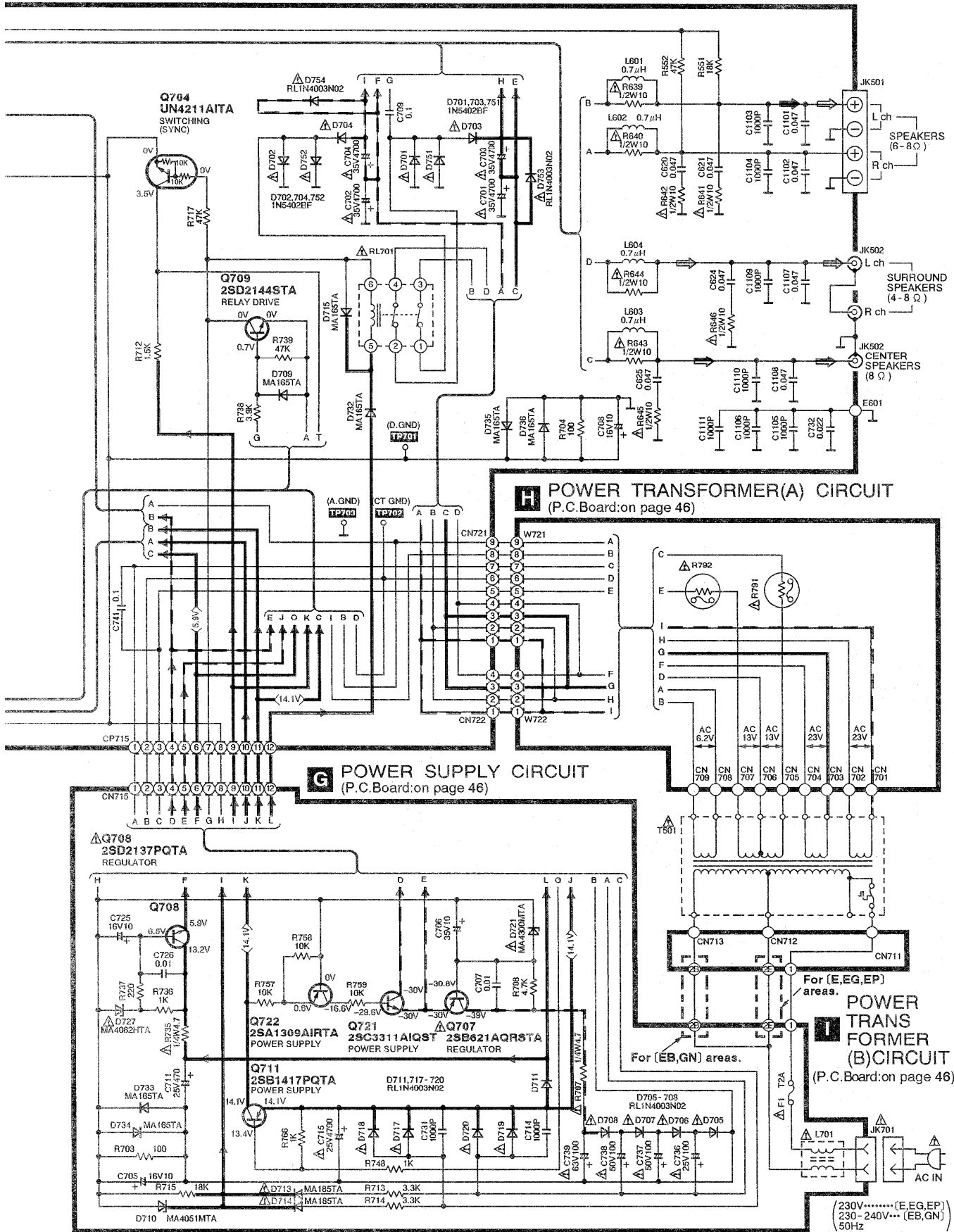

POWER SOURCE CIRCUIT For [GC] area.

**H** POWER TRANSFORMER(A) CIRCUIT  
(P.C.Board: on page 47)

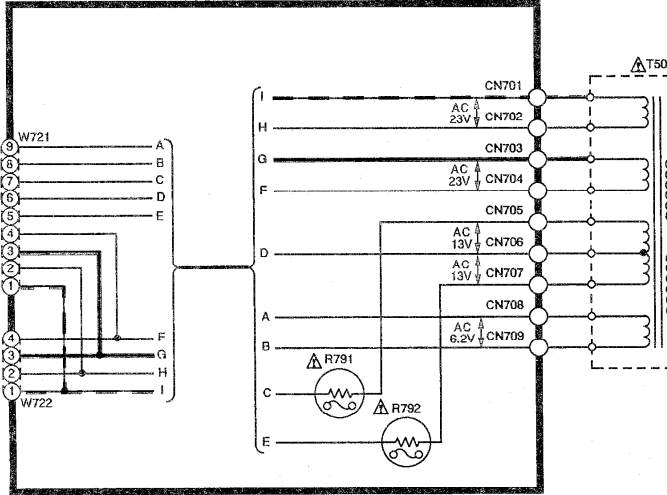

**L** POWER TRANSFORMER(B) CIRCUIT  
(P.C.Board: on page 47)

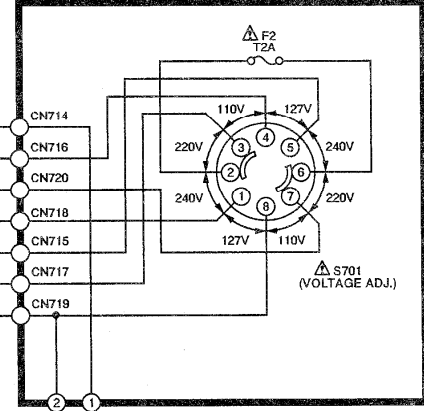

**G** POWER SUPPLY CIRCUIT  
(P.C.Board: on page 47)

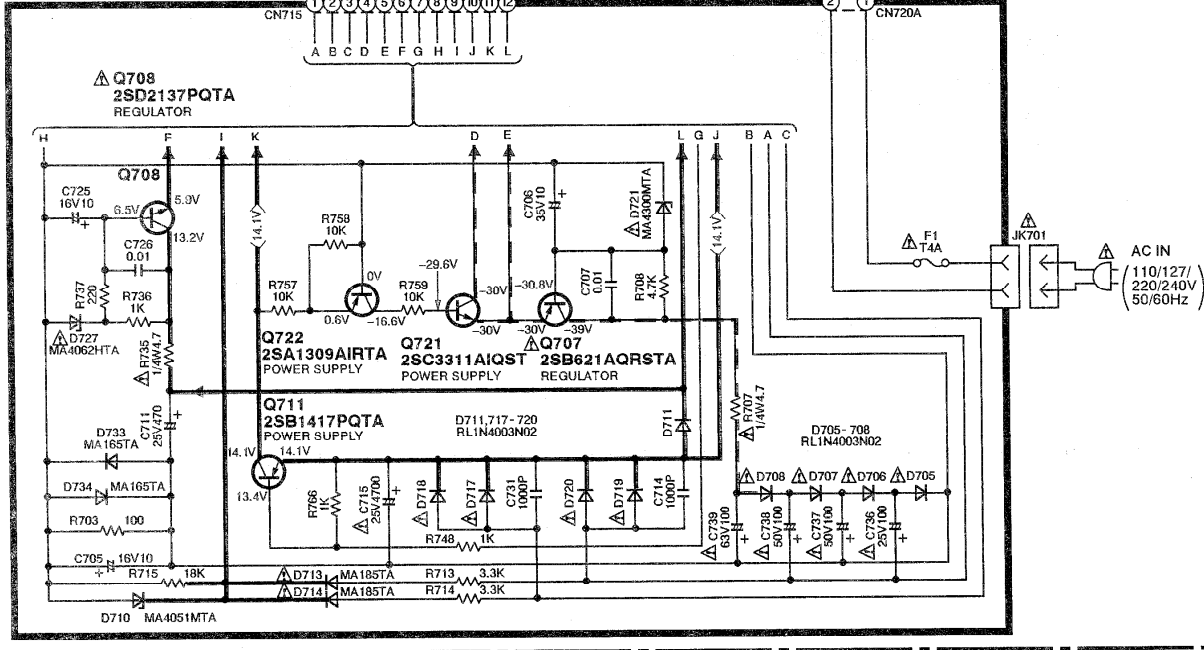

- : Positive voltage Line
- : Negative voltage Line
- : Surround Speaker signal Line
- : AM signal Line
- : FM signal Line
- : Mic signal Line
- : Center Speaker Drive signal Line

**J** RDS CIRCUIT For [EG,EP] areas. (P.C.Board: on page 46)

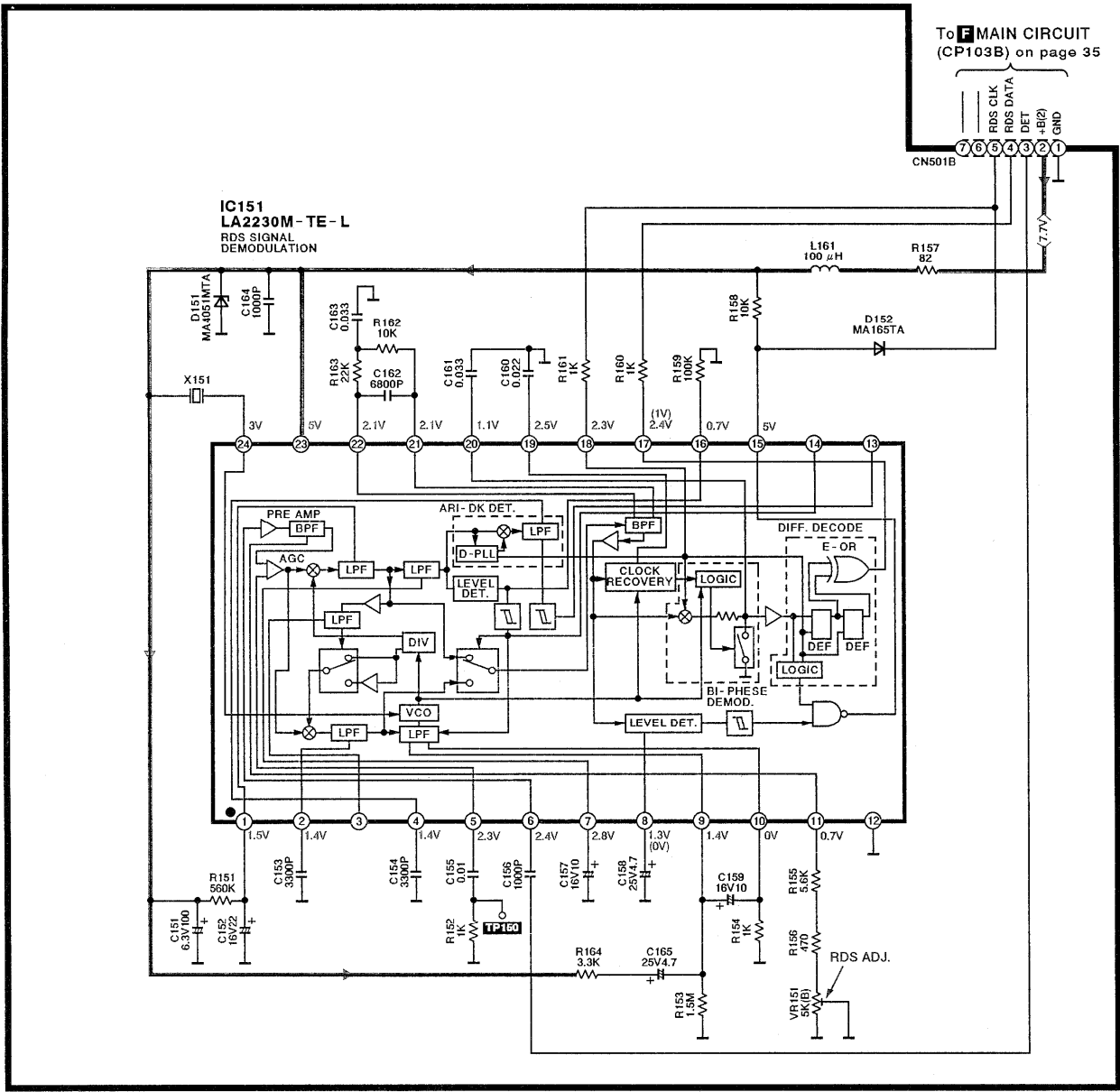

: Positive voltage Line