

Service Manual

AV Control Stereo Receiver

Receiver

SA-EX400

Colour

(K) Black Type

Simplified

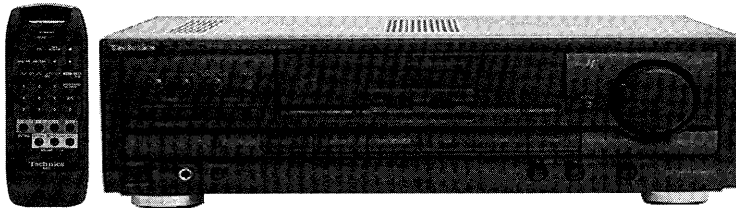

Area

Suffix for Model No.	Area	Colour
(P)	U.S.A	(K)
(PC)	Canada	

* Manufactured under license from Dolby Laboratories Licensing Corporation. Additionally licensed under one or more of the following patents: U.S. numbers 3,632,886, 3,746,792 and 3,959,590; Canadian numbers 1,004,603 and 1,037,877.

"Dolby" and the double-D symbol are trademarks of Dolby Laboratories Licensing Corporation.

Please file and use this manual together with the service manual for Model No. SA-EX500 (P/PC), Order No : MD9512131C1

Note : • This simplified service manual is provided to indicate the main differences between the original model no. SA-EX500 (P/PC) and the subsequent model SA-EX400 (P/PC) respectively.

CHANGES

Parts Comparison Table

Notes: • The parenthesized in the Description column specify the areas. (Refer to the cover page for area.)
Parts without these indication can be used for all areas.
• [MAV] in the Description column indicates parts that are supplied by MAV.

Ref. No.	Description	Change of Parts Number		Remarks
		SA-EX500 (P/PC) (Original)	➔ SA-EX400 (P/PC)	
CABINET AND CHASSIS				
2	REAR PANEL (P) [MAV]	RGR0234B-A	RGR0234B-C	Changed
2	REAR PANEL (PC) [MAV]	RGR0234B-B	RGR0234B-D	Changed
12	MODE BUTTON [MAV]	RGU1350-K	RGU1350A-K	Changed
16	FRONT PANEL ASS'Y [MAV]	RFKGAEX500PK	RFKGEX400PK	Changed
29	LED COVER [MAV]	—	RMV0113	Added
30	SFC BUTTON [MAV]	—	RGU1397-Q	Added
31	DOLBY BUTTON [MAV]	RGU1352B-K	RGU1352C-K	Changed
TRANSISTORS				
Q931	TRANSISTOR	—	RVTDTTC114YST	Added
Q933	TRANSISTOR	—	RVTDTTC114YST	Added
Q935	TRANSISTOR	—	RVTDTTC114YST	Added

⚠ WARNING

This service information is designed for experience repair technicians only and is not designed for use by the general public. It does not contain warnings or cautions to advise non-technical individuals of potential dangers in attempting to service a product. Products powered by electricity should be serviced or repaired only by experienced professional technicians. Any attempt to service or repair the product or products dealt with in this service information by anyone else could result in serious injury or death.

Technics®

© 1996 Matsushita Electronics (S) Pte. Ltd.
All rights reserved. Unauthorized copying and distribution is a violation of law.

Ref. No.	Description	Change of Parts Number		Remarks		
		SA-EX500 (P/PC) (Original)	SA-EX400 (P/PC)			
DIODES						
D931	DIODE	—	LN440YCP	Added		
D933	DIODE	—	LN440YCP	Added		
D935	DIODE	—	LN440YCP	Added		
SWITCHES						
S955	SW, SLEEP	—	EVQ21405R	Added		
S971	SW, THEATER	EVQ21405R	—	Deleted		
S973	SW, CLUB	EVQ21405R	—	Deleted		
RESISTORS						
R931	RESISTOR	150	1/4W	—	ERDS2TJ151T	Added
R933	RESISTOR	150	1/4W	—	ERDS2TJ151T	Added
R935	RESISTOR	150	1/4W	—	ERDS2TJ151T	Added
ACCESSORIES						
A5	INST. MANUAL ASS'Y (PC) [MAV]	RFKSAEX500PC	RFKSEX400PCK	Changed		
A5	INSTRUCTION MANUAL (P) [MAV]	RQT3278-P	RQT3556-P	Changed		
PACKING MATERIAL						
P3	PACKING CASE [MAV]	RPG2828	RPG2829	Changed		

Printed Circuit Board

C MOTOR P.C.B. (REP2305A-S)

B PANEL P.C.B. (REP2305A-S)

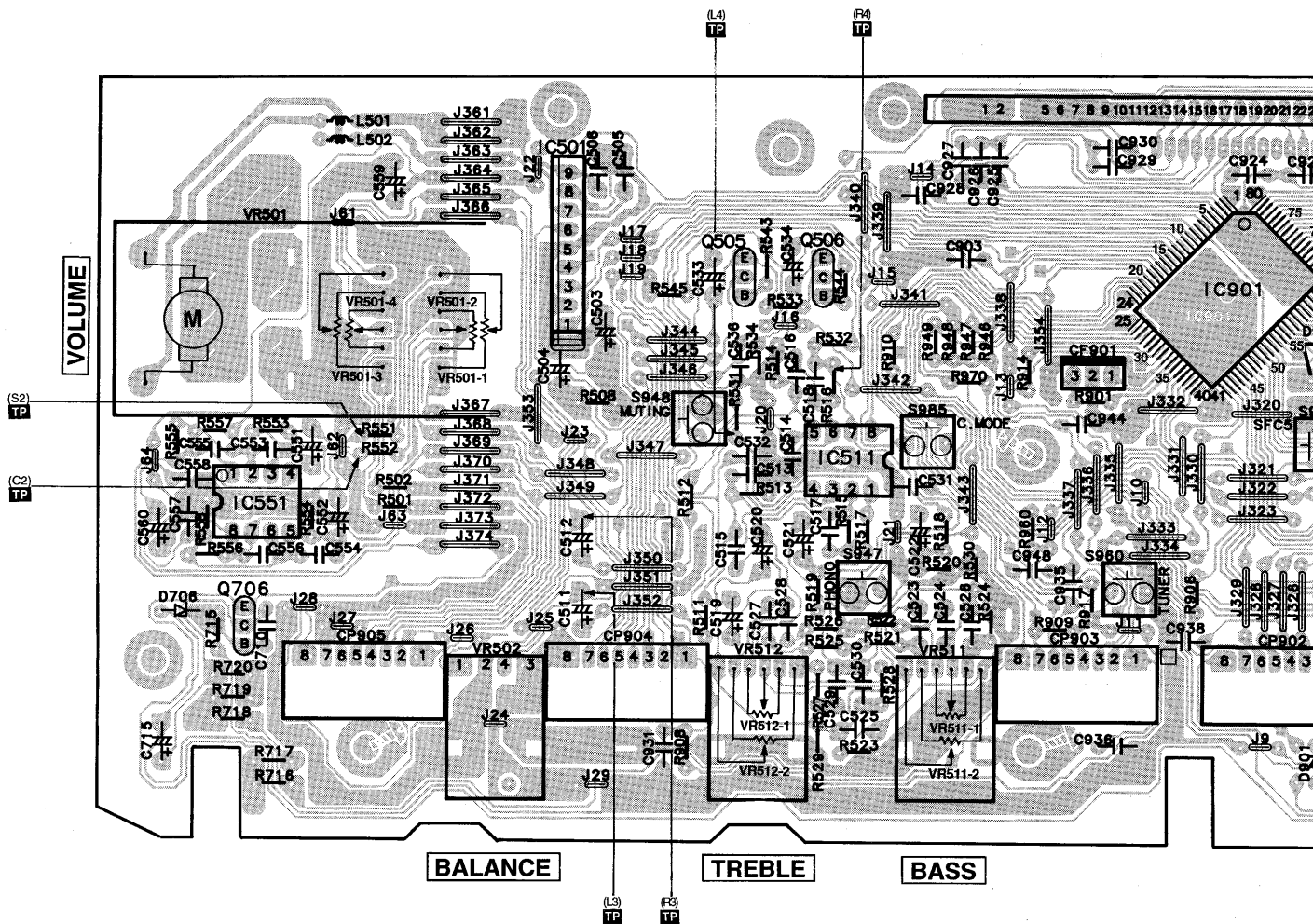

■ Cabinet Parts Location

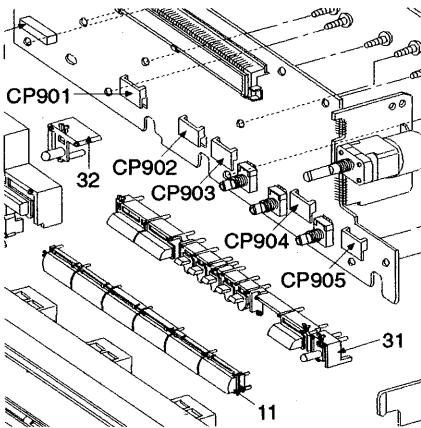

SA-EX500(P/PC) Original
(from page 40)

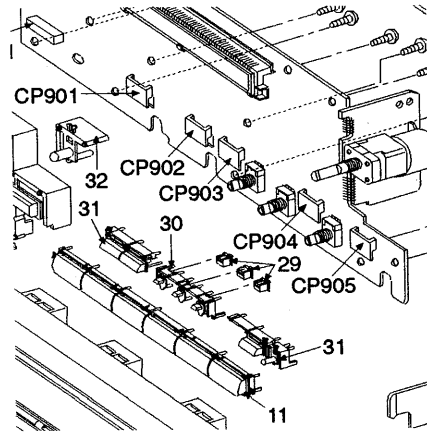

SA-EX400(P/PC)

For Headphone Jack P.C.B. and Power Switch P.C.B.
 REP2303A-S ... SA-EX500(P/PC) changed to REP2305A-S ... SA-EX400(P/PC)

SENSOR

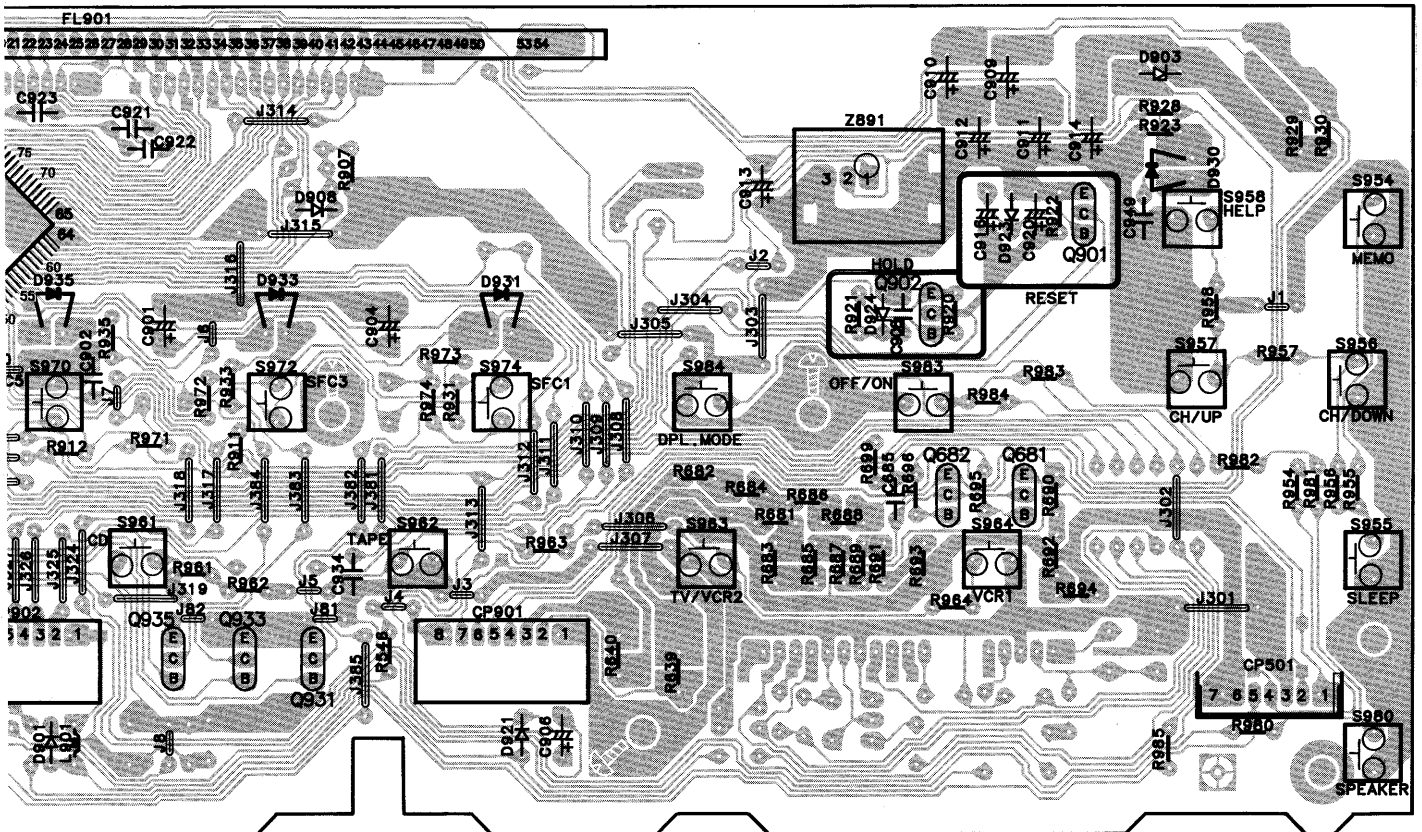

Schematic Diagram

PANEL CIRCUIT

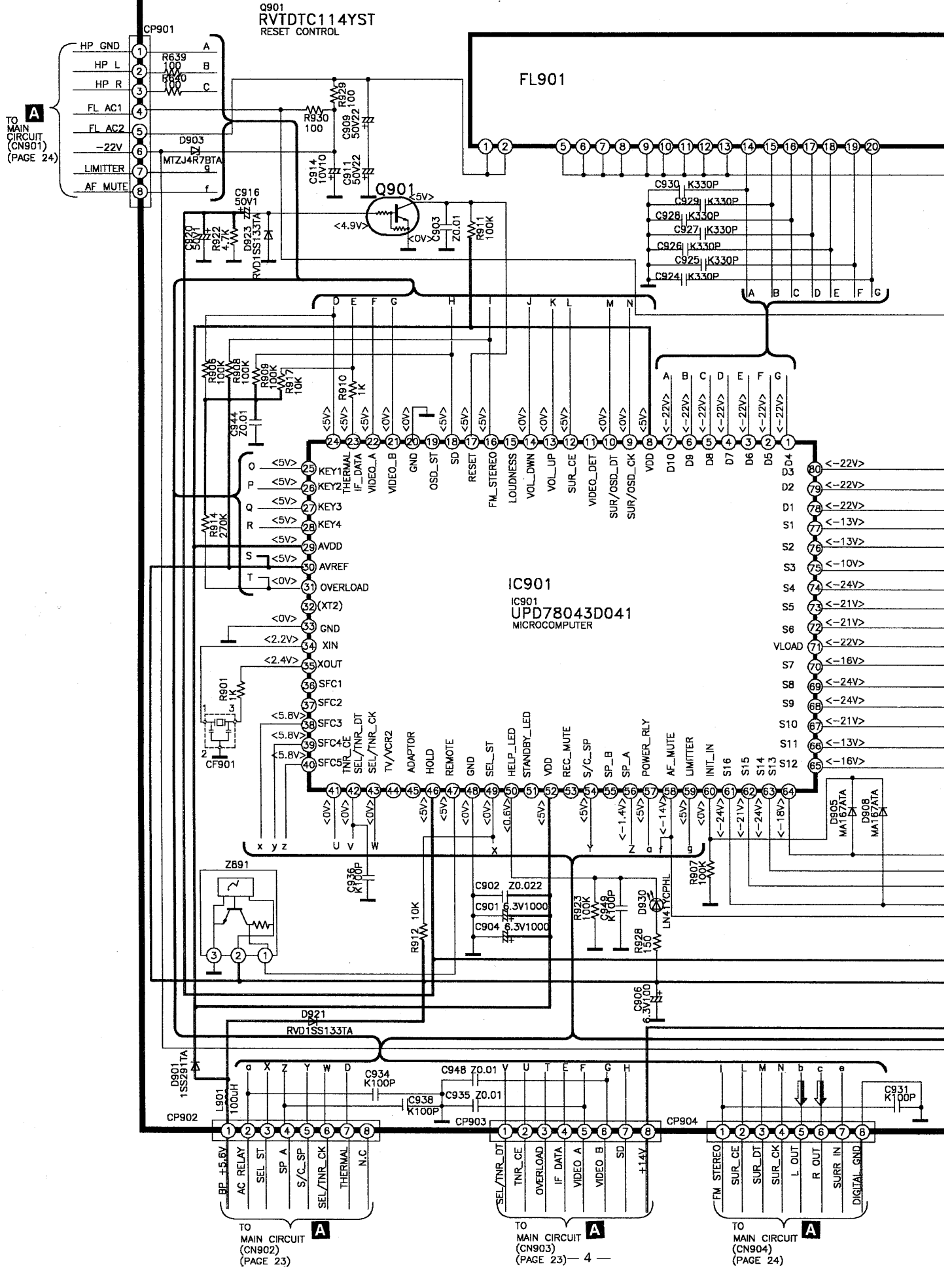

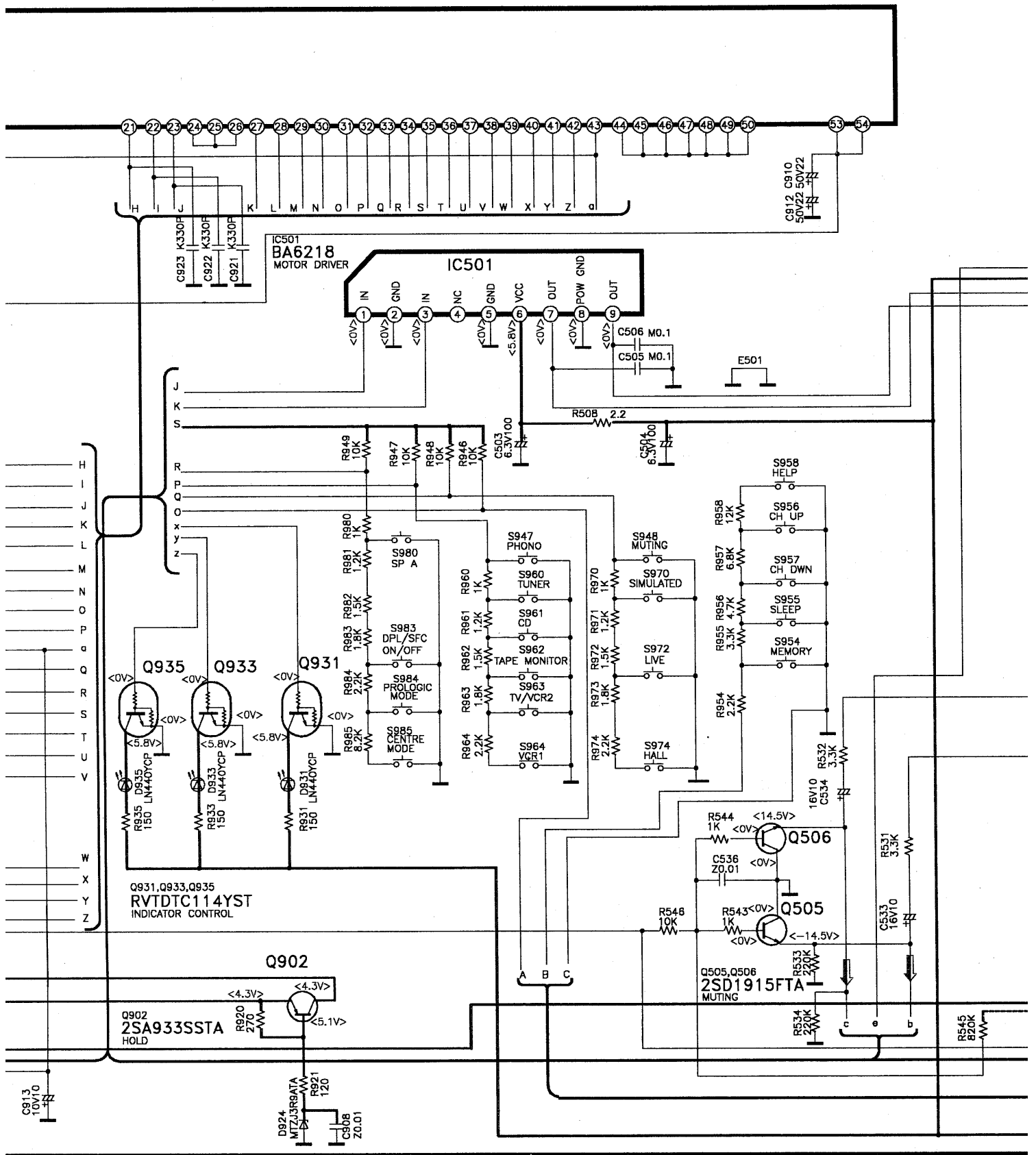

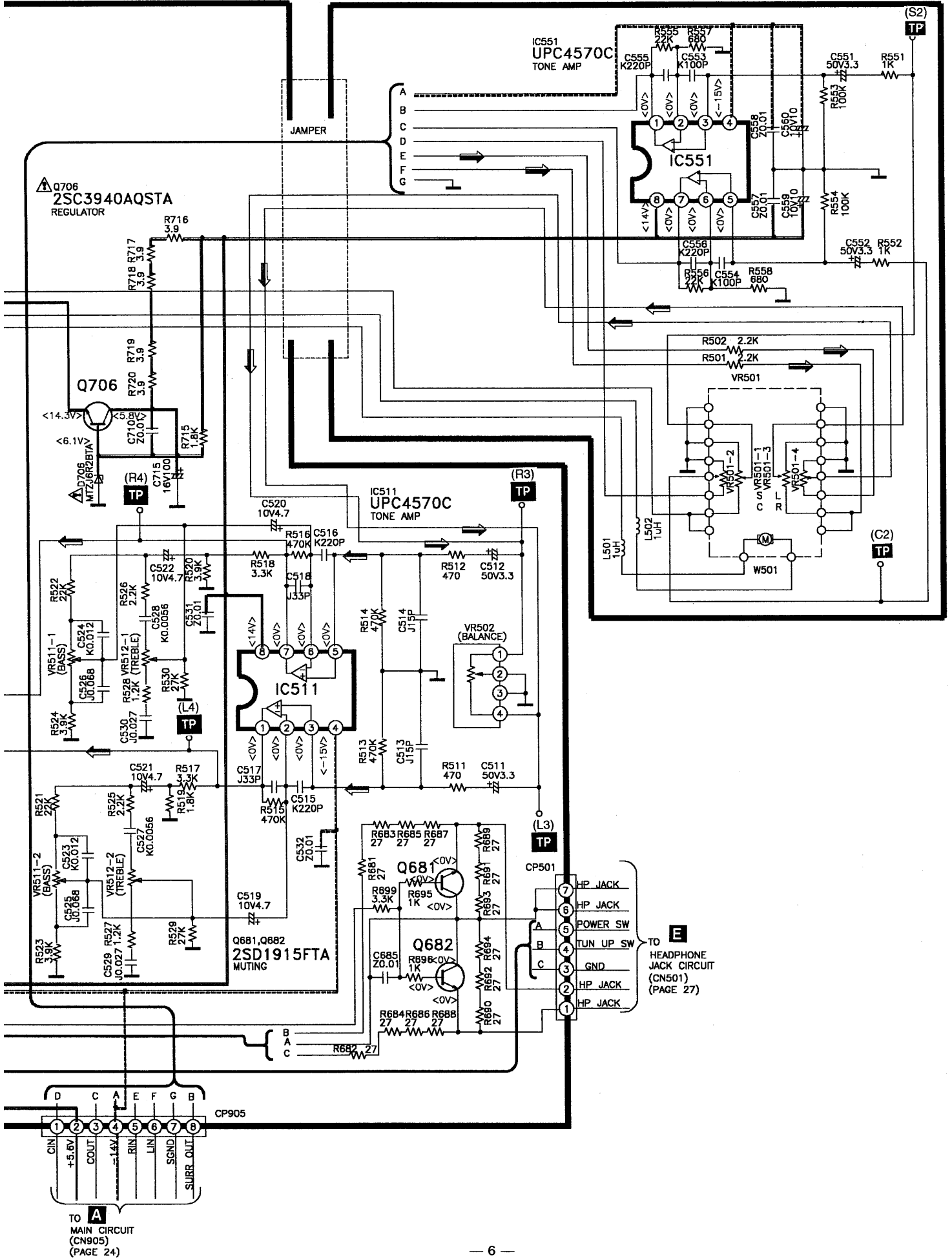

C MOTOR CIRCUIT

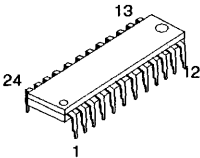
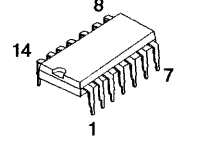
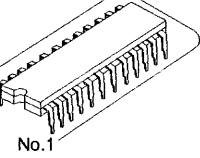
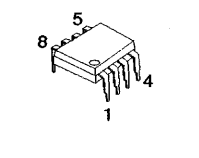
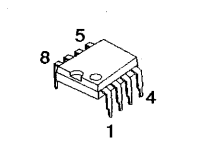
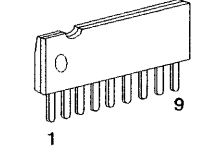
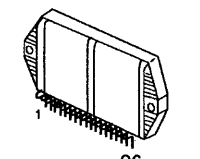
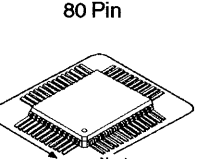
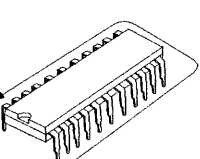
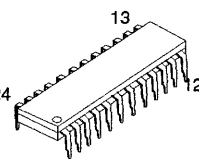
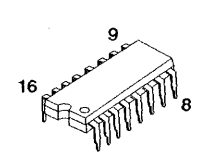
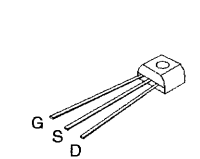
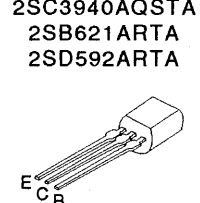
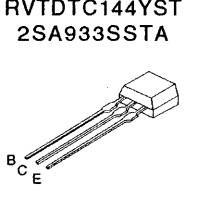
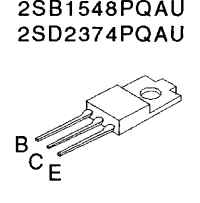
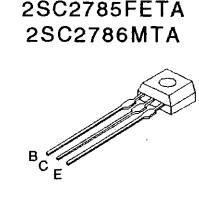

Terminal Guide of ICs, Transistors and Diodes

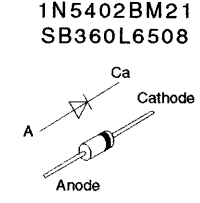
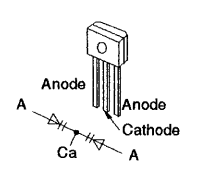
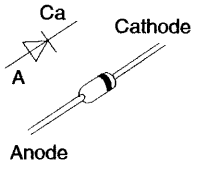
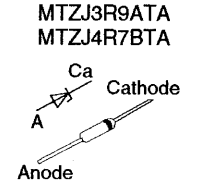
<p>LA1832A LC7218</p> 	<p>NJM2279D</p> 	<p>TC9163N 28Pin</p> 	<p>M5218AP</p> 	<p>AN6558-F UPC4570C</p> 	<p>BA6218</p> 
<p>RSN3305-P</p> 	<p>UPD78043A041 80 Pin</p> 	<p>LA2785</p> 	<p>LV1010N</p> 	<p>TC9214P</p> 	<p>2SK544F-AC</p> 
<p>2SC3940AQSTA 2SB621ARTA 2SD592ARTA</p> 	<p>RVTDTC144YST 2SA933SSTA</p> 	<p>2SB1548PQAU 2SD2374PQAU</p> 	<p>2SC2785FETA 2SC2786MTA</p> 	<p>2SC2787FL1TA 2SC2787LTA 2SA1309ARTA 2SC3311ARTA 2SD1915FTA UN411FTA UN421FTA UN4119TA</p> 	<p>1N5402BM21 SB360L6508</p> 
<p>SVC211SPA-AL</p> 		<p>RVD1SS133TA 1SR35200TB MA700ATA 1SS291TA MA167ATA</p>	<p>MTZJ10CTA MTZJ3R9ATA MTZJ4R7BTA</p> 	<p>MTZJ6R2BTA MTZJ6R8BTA MTZJ7R5CTA MTZJ5R1BTA MTZJ5R6BTA MTZJ3R0ATA MTZJ30DTA MTZJ15CTA MTZJ8R2BTA</p>	<p>LN41YCPHL LN440YCP</p> 