

TR401, 402 25A640A-D
 TR403 25C1328
 TR404 25A794
 TR406 25C1567

TR406 25C828
 TR407 25D381
 TR408 25B536
 TR409 25D2878

TR410 25B5396

D401 MA150
 D402, 403 SVDEGA0112R

D1 RVDSG5TS
 D2 RVDS05TR

TR801, 804
 TR808, 803, 802, 803
 TR804, 806, 801

28D390A
 28C509
 28A777

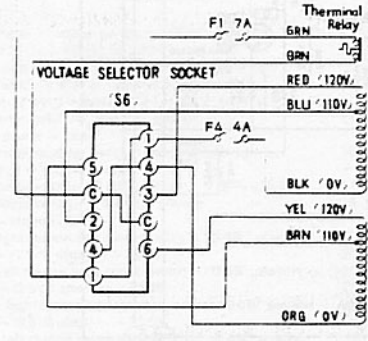
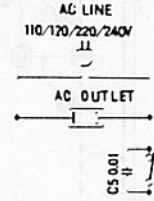
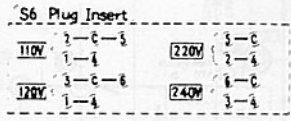
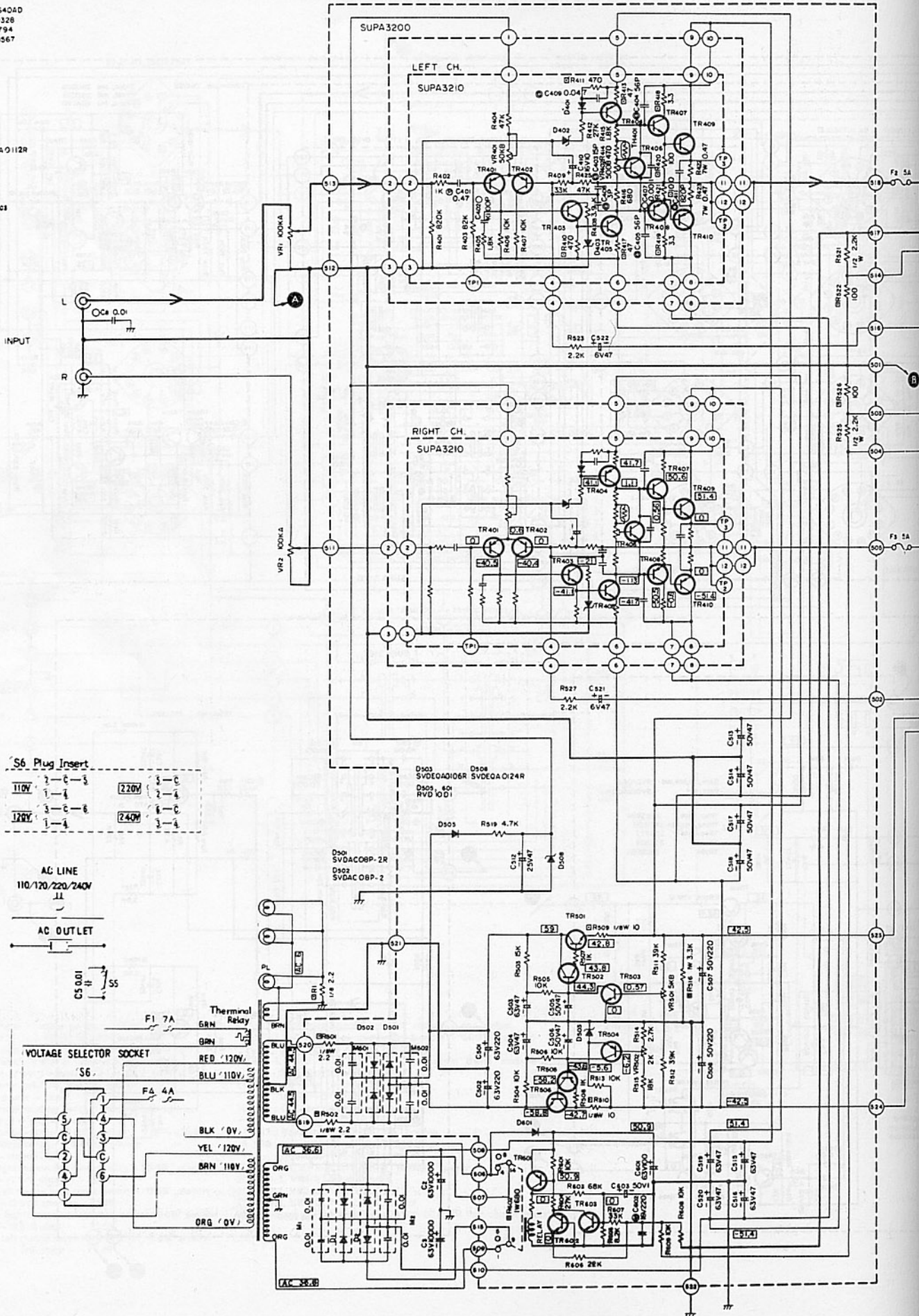

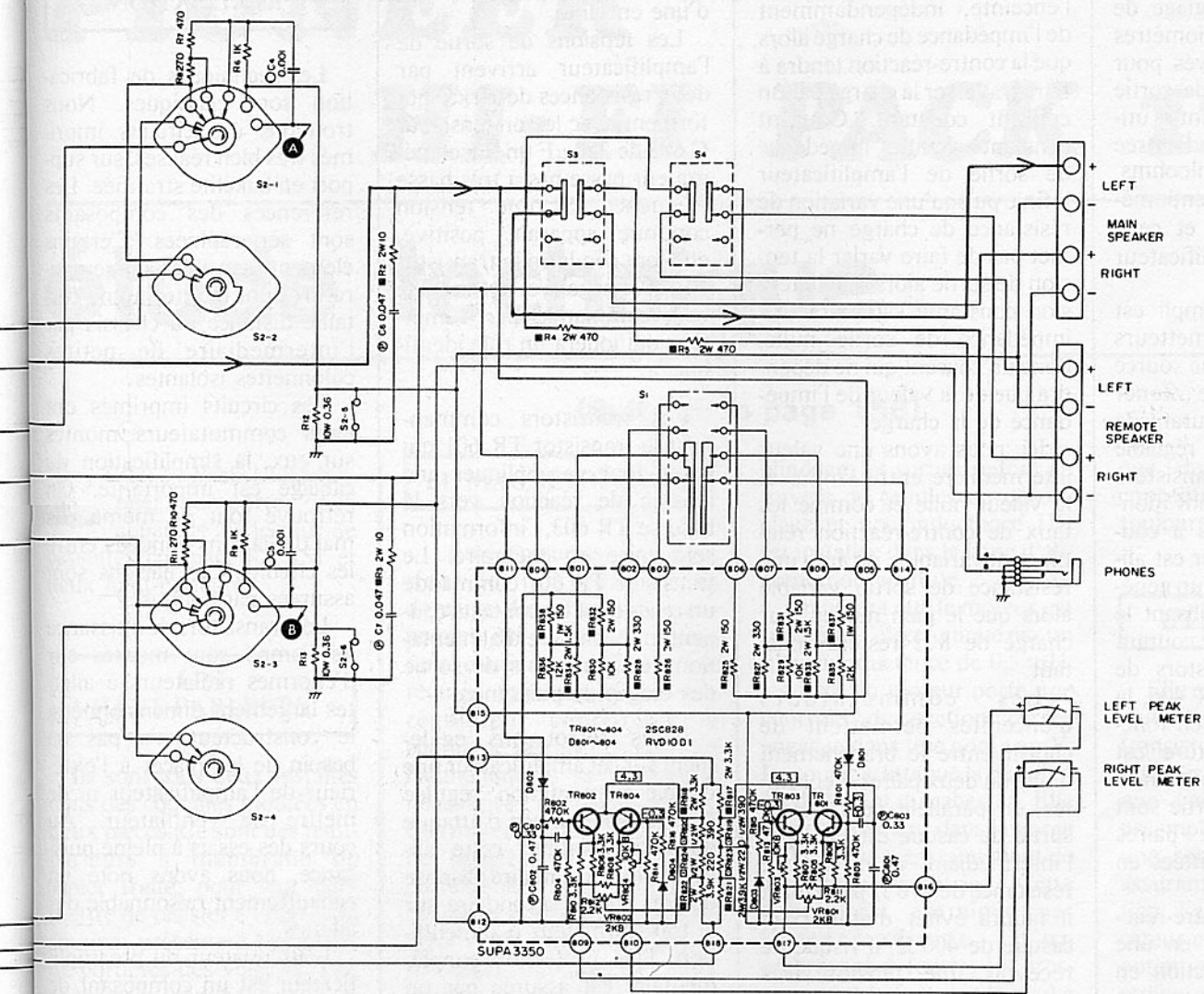

Notes :

1. **S1** : Meter range selector switch in "X1" position.
X1 ↔ X0.1 ↔ X0.01
2. **S2-1~S2-6** : Output impedance (damping factor) selector switch in "normal (0.08Ω)" position.
normal (0.08Ω) ↔ 0.8Ω ↔ 2.7Ω ↔ 8Ω
S2-5, S2-6 is short condition, when output impedance selector switch is normal position only.
3. **S3** : Main speakers switch in "on" position.
4. **S4** : Remote speakers switch in "on" position.
5. **S5** : Power source switch in "on" position.
6. **S6** : Voltage selector socket.
7. **RELAY 1** : Speakers protection relay in "normal" position.
8. DC voltage measurements are taken with DC VTVM from chassis ground.
9. Right channel main amplifier is same as left channel main amplifier.

