

Service Manual

Portable MD Recorder

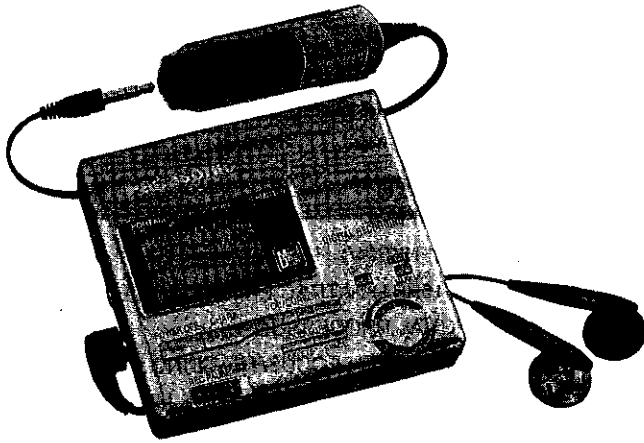

SJ-MR100

MD unit: RAE1620Z Mechanism Series

Colour

(S).....Silver Type

Areas

EB.....Great Britain.

EG.....Europe.

GH.....Hong Kong.

Specifications

●Audio

System:	MiniDisc digital audio system
Laser:	Semiconductor laser (=780 nm)
Sampling frequency:	44.1 kHz
Coding:	Adaptive Transform Acoustic Coding (ATRAC)
No. of channels:	2 (left and right, stereo) 1 (monaural)
Frequency response:	20 Hz-20 kHz (+0 dB, -8dB)
Wow and flutter:	Below measurable limit

●General

Input terminal

OPT/LINE IN jack

Impedance:	47k Ω
Input level:	SENS H: 178mV SENS L: 500mV

MIC jack

Impedance:	600 Ω
Input level:	0.4mV

Output terminal

Output Jack:	Phones, 14 Ω
Power output:	5 mW+5 mW

Power supply

Rechargeable battery: DC 1.2V

(included rechargeable battery)

Battery: DC 1.5V (One LR6, AA, UM-3 battery)

AC adaptor: DC 1.8V (included AC adaptor)

Dimensions (WxHxD)

Cabinet dimensions:	84x77x18.9 mm
incl.projecting parts:	84.9x78.3x20.5 mm
Weight:	161 g (with battery) 136 g (without battery)

●Play time

(When used in hold mode, at 25°C, on a flat, stable surface)

Battery type:	Play time	Record time
Rechargeable:	About 8.5 hours	About 4.5 hours
Panasonic alkaline:	About 10.5 hours	About 2.0 hours
Both together:	About 20 hours	About 9.5 hours

●Charger

Input: AC 220 V (GH) / AC230 V (EG) / AC 240V (EB), 50/60 Hz 8W

Recharging time: About 3 hours

Panasonic®

© 1999 Matsushita Electric Industrial Co., Ltd.
All rights reserved. Unauthorized copying and distribution is a violation of law.

Notes:

- The play time may be less depending on the operating conditions.
- Specifications are subject to change without notice. Weight and dimensions are approximate.

⚠ WARNING

This service information is designed for experienced repair technicians only and is not designed for use by the general public. It does not contain warnings or cautions to advise non-technical individuals of potential dangers in attempting to service a product. Products powered by electricity should be serviced or repaired only by experienced professional technicians. Any attempt to service or repair the product or products dealt with in this service information by anyone else could result in serious injury or death.

CONTENTS

	Page		Page
1 Precaution of Laser Diode	2	11 Schematic Diagram	46
2 Accessories	3	12 Printed Circuit Board and Wiring Connection Diagram	55
3 Operating Instructions	3	13 Block Diagram	59
4 Handling Precautions for Traverse Deck (Mechanism Unit)	20	14 Wiring Connection Diagram	65
4.1. Mechanism Unit (optical pickup)	20	15 Terminal Function of IC's	65
4.2. Caution for repairing of MD mechanism (optical pickup)	20	15.1. IC1 (AN8772FHKEBV) : RF AMP	65
4.3. Grounding for electrostatic breakdown prevention	20	15.2. IC101 (M6616RB1) : ATRAC ENCODER/DECORDER, SERVO SIGNAL PROCESSOR	66
5 Operation Checks and Main Component Replacement		15.3. IC301 (BD6604KVT) : FOCUS/TRACKING COIL, TRAVERSE MOTOR DRIVE, SPINDLE MOTOR DRIVE, ROTARY DETECTOR	67
Procedures	21	15.4. IC501 (MN101CF32GCA) : SYSTEM CONTROL	68
6 Operating Procedures	28	16 Caution in Use of Rechargeable Battery Ass'y	69
6.1. Operating Procedures	28	17 Supply of Rechargeable Battery Ass'y as Replacement Parts	
6.2. Block Diagram	29	69
7 Measurements and Adjustments	30	18 Resolution Procedure and Parts Format of Remote	
7.1. Laser Power Adjustment	31	Controller's Clip Unit	69
7.2. Self-diagnosis Function	33	19 Replacement Parts List	70
8 Troubleshooting Guide	34	20 Cabinet Parts Location	74
9 Checking Procedures of Main Components Parts on the Main		21 Packaging	75
P.C.B. (B side)	43		
10 Schematic Diagram Notes	44		
10.1. Schematic Diagram Notes	44		
10.2. Type Illustration of IC's, Transistors and Diodes	45		

1 Precaution of Laser Diode**CAUTION:**

This product utilizes a laser diode with the unit turned "on", invisible laser radiation is emitted from the pickup lens.

Wave length: 780 nm

Maximum output radiation power from pickup: 100 μ W/VDE

Laser radiation from the pickup lens is safety level, but be sure the followings:

1. Do not disassemble the optical pickup unit, since radiation from exposed laser diode is dangerous.
2. Do not adjust the variable resistor on the pickup unit. It was already adjusted.
3. Do not look at the focus lens using optical instruments.
4. Recommend not to look at pickup lens for a long time.

ACHTUNG:

Dieses Produkt enthält eine Laserdiode. Im eingeschalteten Zustand wird unsichtbare Laserstrahlung von der

Lasereinheit abgestrahlt.

Wellenlänge: 780 nm

Maximale Strahlungsleistung der Lasereinheit: 100 μ W/VDE

Die Strahlung der Lasereinheit ungefährlich, wenn folgende Punkte beachtet werden:

1. Die Lasereinheit nicht zerlegen, da die Strahlung an der freigelegten Laserdiode gefährlich ist.
2. Den werkseitig justierten Einstellregler der Lasereinheit nicht verstellen.
3. Nicht mit optischen Instrumenten in die Fokussierlinie blicken.
4. Nicht über längere Zeit in die Fokussierlinie blicken.

2 Accessories

- Rechargeable battery with carrying case1pc.
(RFKFBP140HSY)
- Battery case.....1 pc.
(RFA1320-S)
- Carrying case.....1pc.
(RFC0056-K)
- Wired remote control.....1pc.
(RFEV023P-SM)
- Stereo earphones.....1 pc.
(RFEV319P-SA)

- Line cable.....1pc.
(RJL2P007X08)

For EB area

- AC adaptor.....1pc.
(RFEA003B-S)

For EG area

- AC adaptor.....1pc.
(RFEA002E-S)

For GH area

- AC adaptor.....1pc.
(RFEA004H-S)

3 Operating Instructions

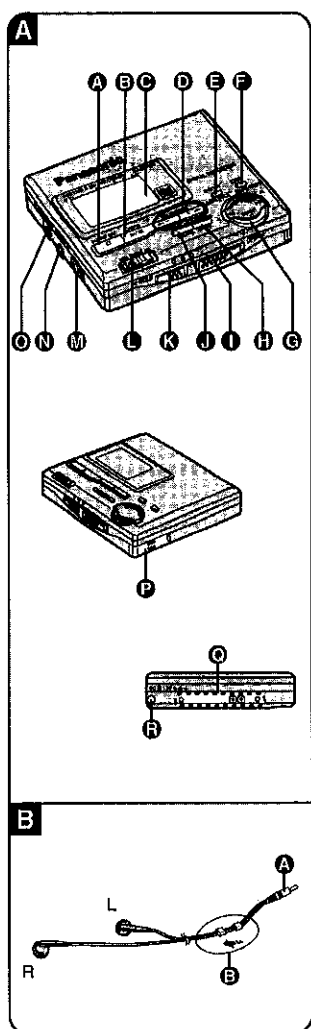

Location of controls

Main unit

- A** Stop/power off/edit cancel button (■, POWER OFF)
- B** Play/record/pause/power on/character type button (▶/■, CHARA)
- C** Display
- D** Volume/cursor buttons (←, →, VOL/CURSOR)
- E** Display, capital/lower case button (DISPLAY, CAPS LOCK)
- F** Changing edit mode, changing track mark mode, completing edit button (EDIT, MARK MODE)
- G** Jog dial (◀◀, ▶▶, ENTER ▶)
- H** Tone/recording sensitivity/space button (EQ/REC SENS, SPACE)
- I** Open switch (OPEN)
- J** Play and record mode/character delete button (MODE, DELETE)
- K** Hold switch (◀ HOLD)
- L** Recording pause/power on switch (REC PAUSE)
- M** Headphone jack (🎧)
- N** Optical digital in/line in jack (OPT/LINE IN)
- O** Microphone jack ((PLUG IN POWER) MIC)
- P** Rechargeable battery compartment cover (◀ OPEN)
- Q** Connection terminal for battery case
- R** DC in jack (DC IN 1.8 V ⚡)

Stereo earphones

- A** Plug
- B** Slider
Slide up to prevent tangling the cord when the earphones are not in use.

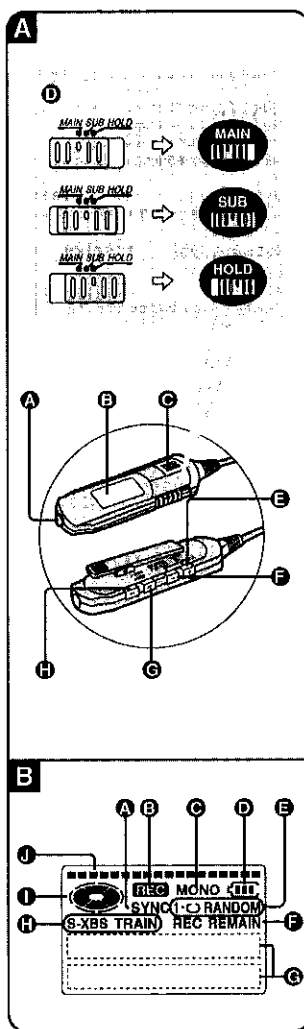

Location of controls

Wired remote control

- A** Earphone jack
- B** Display
- C** Play/record/stop button
- D** Function selector/hold switch (MAIN, SUB, HOLD)
The operation depends on the position of this switch. Ensure the switch is in the correct position before using the remote control. These symbols are used to indicate the position of this switch in the instructions.
- E** Volume control/tone control/track mark button (VOL +, EQ, T.MARK)
- F** Volume /play mode/recording pause button (VOL -, PLAY MODE, REC PAUSE)
- G** Skip/search(forward)/light/display button (▶▶, •LIGHT = DISP)
- H** Skip/search (backward) button (◀◀)

An operation tone sounds when buttons on the remote control are pressed. This tone is represented in these instructions by "♪".

Display information

- A** Synchronized recording display
- B** Recording display
- C** Monaural play/record display
- D** Battery indication
- E** Play mode
- F** Remaining recording time
- G** Text
- H** Sound quality
- I** Disc mark
- J** Level meter

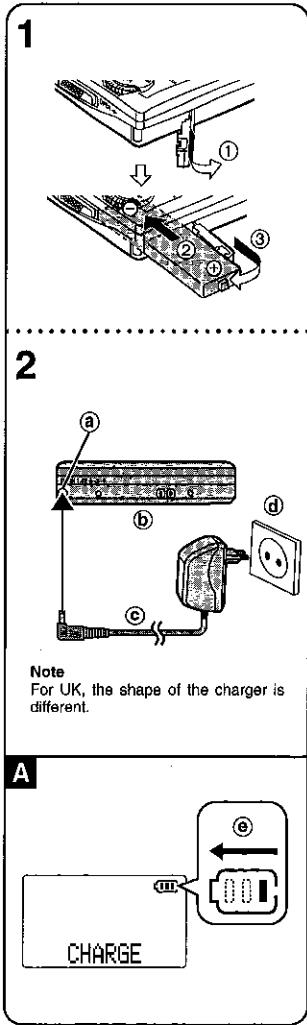

Power source

The rechargeable battery (included)

1 Put the battery into the unit.
The unit cannot recharge batteries other than the one supplied or recommended replacements.

2 Connect the AC adaptor.

- Ⓐ DC IN jack (DC IN 1.8 V ⚡)
 - Ⓑ Back panel of the unit
 - Ⓒ AC adaptor (included)
 - Ⓓ Household mains socket
- Recharging begins.
"CHARGE" appears on the display while recharging.
- Ⓔ Scrolls

"CHARGE" disappears when the battery is fully charged. It takes approximately 3 hours to recharge the supplied battery.

3 Disconnect the AC adaptor from the [DC IN 1.8 V ⚡] terminal and the household mains socket.

Note

• The unit can only be recharged while it is off.

• The AC adaptor and battery may become warm during recharging but this is normal.

Recharging time and duration.

(When using the included rechargeable battery.)

Charging: Approx. 3 hours

Playback: Approx. 8.5 hours

Recording: Approx. 4.5 hours

• Duration may be reduced under some conditions.

• If the unit is to be used for long periods, such as during recording, use the AC adaptor to power it.

Rechargeable number of times

About 300.

The battery has reached the end of its useful life if play time dramatically reduces after recharging.

Replacement

Nickel-metal hydride rechargeable battery (RFKFBP140HSY).
Please inquire at a Panasonic dealer for a replacement.

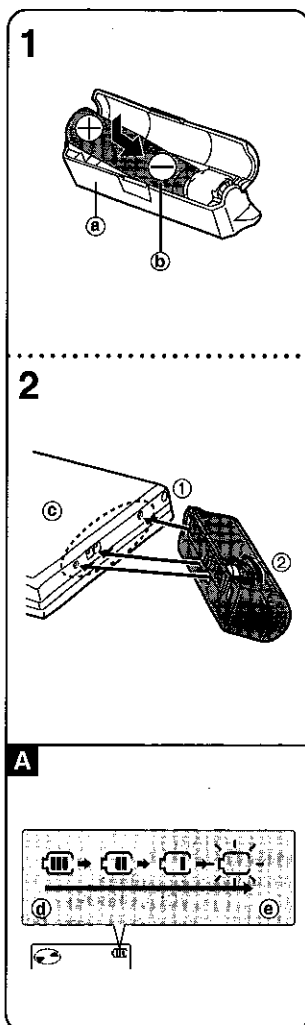

Power source

Dry cell battery (not included)

Use one LR6 alkaline battery. Use long-life Panasonic alkaline batteries.

1 Put the battery into the battery case.

- Ⓐ External battery case (included)
- Ⓑ One LR6, AA, UM-3 battery (not included)

2 Attach the case to the unit.

- Ⓒ Bottom of the unit

Note

Insert the rechargeable battery when recording on dry cell batteries.

The battery indicator

The illustration shows how the indicator on the remote control display appears as battery power runs down.

- Ⓒ Full
- Ⓓ Empty

When the indicator starts flashing

The battery is almost flat and should be replaced or recharged.

For longer use

• You will be able to playback for 20 hours and record for 9.5 hours if the two types of batteries are used together.

• We recommend using long-life Panasonic alkaline batteries.

Using the AC adaptor (included)

Connect the AC adaptor.

Refer to the step 2 of "The rechargeable battery" for connection instructions.

Note

• The unit is in the standby condition when the AC adaptor is connected. The primary circuit is always "live" as long as the AC adaptor is connected to an electrical outlet.

• Use only the supplied AC adaptor. Use of other adaptors can damage the unit. If the unit is not to be used for a long time disconnect the AC adaptor from the household mains socket and turn the unit off to save power.

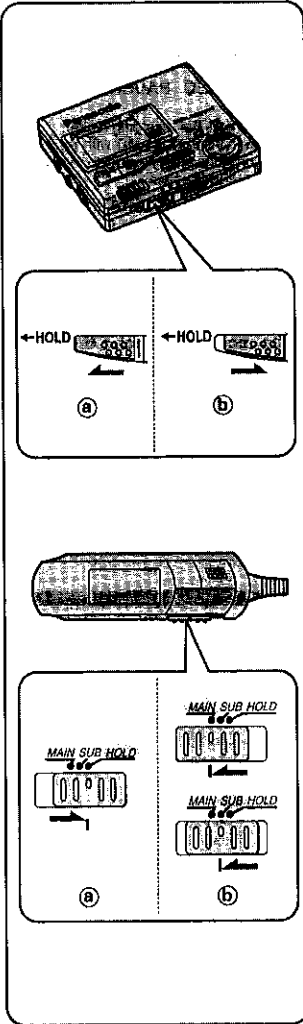

The HOLD function

This function stops the player and remote control from responding when a button is pressed.

- Ⓐ Hold mode
- Ⓑ Release

■ Guards against the following

- The unit is powered on accidentally when not in use, causing the batteries to run down.
- A button is accidentally pressed during play or recording, interrupting the operation.

Note

There is a HOLD switch on both the player and remote control, each of which works independent of the other.

■ The "HOLD" display

This is displayed for about 2 seconds on the main unit's and the remote control's display panels when the following occurs.

- The main unit is on hold and a button is pressed. (If off, display appears only if [▶/II], [CHARA] or [REC PAUSE] is operated.)
- The remote control's switch is moved to hold. The display also lights for about 5 seconds at this time.

Before recording

The two methods of recording

Digital

This method records the digital signals from CDs. Compared to analogue recording, this method makes it possible to make recordings of higher quality. Purchase an optical fiber cable (RP-CA2120 or RP-CA2220, sold separately) to record digitally.

Analogue

Use this method to make analogue recordings of digital material, CDs and MDs, and to record analogue sources such as the radio. Use the included line cord to make analogue recordings.

The recording modes

Normal

This method allows you to start and stop recording manually.

Synchronized

This method starts and stops recording at the same time as the source being record. Available with both digital and analogue recording.

One track synchronized

The first track on a CD is recorded and then the unit goes to recording standby. Recording starts again automatically when the first track on another CD is played. Available only when recording CDs digitally.

Note

This function only works with tracks numbered "1".

Monaural

This mode allows you to record approximately double the amount of material normally possible. (For example, it is possible to record about 148 minutes worth of material onto a 74 minute MD.) Available only when analogue recording.

Before recording

Track marks

■ Track marks and track numbers

Like CDs, it is possible to select and play a track on an MD by selecting its track number. There are marks at the beginning of each track, called track marks, that make this possible. The period between each track mark is called a track.

■ Putting track marks on an MD

Auto mark mode

The unit automatically decides where track marks are to be put.

Manual mark mode

You can manually put the track marks where you want them to go.

Time mark mode (3 MIN, 5 MIN, 10 MIN)

Track marks are put at a preselected distance from each other.

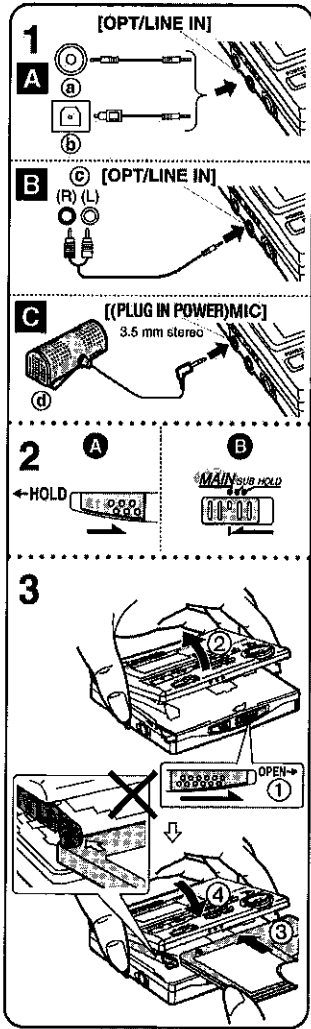

Recording

1 **Digital recording** **A**
Connect this unit to a unit that has a digital output terminal.

- Ⓐ Digital output terminal (portable ↔ portable)
- Ⓑ Purchase an optical fiber cable (RP-CA2220, sold separately).
- Ⓒ Digital output terminal (deck ↔ portable)
- Ⓓ Purchase an optical fiber cable (RP-CA2120, sold separately).

Analogue recording **B**
Connect this unit to a unit that has stereo LINE OUT terminals.

- Ⓔ LINE OUT terminal

Note
 Disconnect other cables from the [(PLUG IN POWER) MIC] terminal.

Recording with a microphone **C**
Connect the microphone.

- Ⓙ Stereo microphone (not included)
- Ⓚ Purchase a stereo microphone (RP-VC200, sold separately).

Note
 • Disconnect other cables from the [OPT/LINE IN] terminal.
 • Stereo recording is made if a stereo microphone is used.

2 Release hold.

- Ⓛ Main unit
 - Ⓜ Remote control
- 3 Open the player and insert a recordable MD.**

- ① Slide [OPEN] to the right.
- ② Open the lid.
- ③ Insert disc with label facing upward. Push the disc in the center until it locks in place.
- ④ Close the lid.

After an MD has been inserted the player turns on, reads the information from it, then, after a minute, the power goes off again.

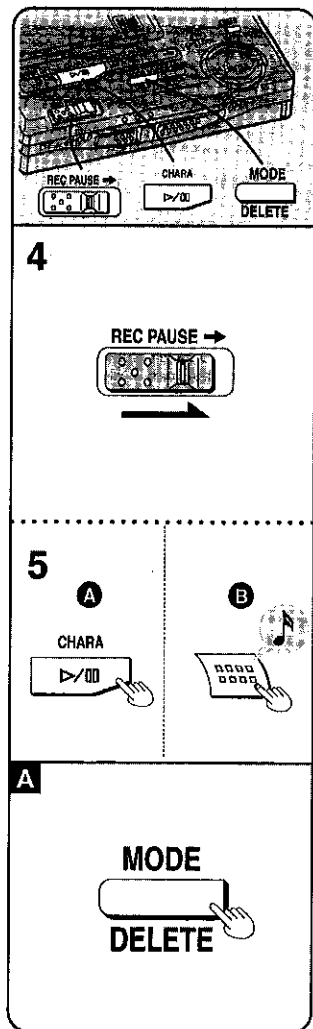

Recording

4 Slide [REC PAUSE] to the right.
 The unit enters the recording mode.
 If you have inserted an MD with recordings already on it, the unit prepares to record on the first available space.

5 Press [▶/II], CHARA] (main unit) or the main button (remote control) to start recording.

- Ⓛ Main unit
- Ⓜ Remote control
- Ⓝ Beep

6 Start playback on the source to be recorded or point the microphone at the source of the sound.

Note
 Recording level is automatically set. Changes to volume will have no effect on recording.

To select the recording mode
 Press [MODE, DELETE] while in recording standby mode. **A**
 Each time the button is pressed the mode changes and an indicator is shown in the following order.

Digital recording
 Normal (No display) → SYNC → SYNC 1

Analogue recording
 Normal (No display) → MONO → SYNC

Recording with a microphone
 Normal (No display) → MONO

SYNC: Synchronized recording
SYNC 1: One track synchronized recording
MONO: Monaural recording

If you have selected
 • **Synchronized recording (SYNC) or One track synchronized recording (SYNC 1)**
 Recording begins automatically when you begin playback of the source.
 • **Monaural recording (MONO)**
 Perform steps 5 to 6 to start recording.

Note
 If you set the recording mode to "SYNC", recording begins immediately if the source is already playing.

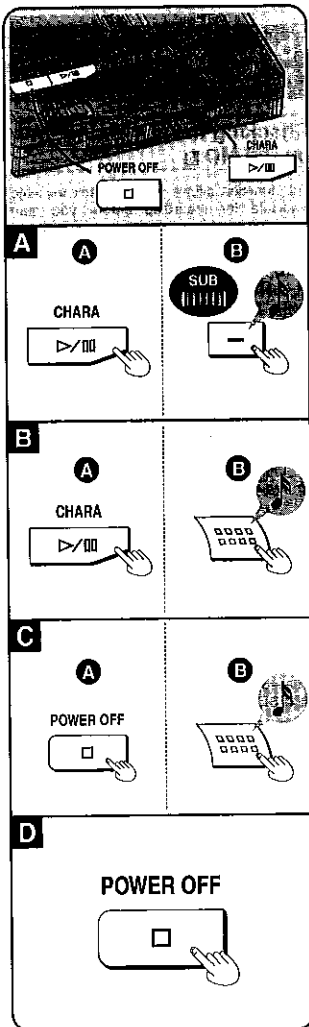

Recording

■ To pause recording

If you have selected

● Synchronized recording (SYNC)

Recording pauses if the source stops or if 2 seconds of silence is detected. (Track number increases by one.)

Recording restarts when the source starts again.

● One track synchronized recording (SYNC 1)

The unit automatically pauses after track 1 finishes. (Track number increases by one.)

Recording restarts when another track numbered 1 is played.

● Normal recording (No display) or monaural recording

Press [▶/II, CHARA] (main unit) or [VOL -, PLAY MODE, REC PAUSE] (remote control) while recording.

(Track number increases by one.)

A Main unit

B Remote control

♪: Beep

■ To restart recording

Press [▶/II, CHARA] (main unit) or the main button (remote control).

A Main unit

B Remote control

♪: Beep

Note

If you set the recording mode to "SYNC" or "SYNC1", you cannot pause recording manually.

■ To stop recording

Press [■, POWER OFF] (main unit) or main button (remote control) while recording.

A Main unit

B Remote control

♪: Beep

● UTOC is recorded.

● The unit will turn off automatically after about 1 minute.

■ To turn the unit off

Press [■, POWER OFF] while stopped.

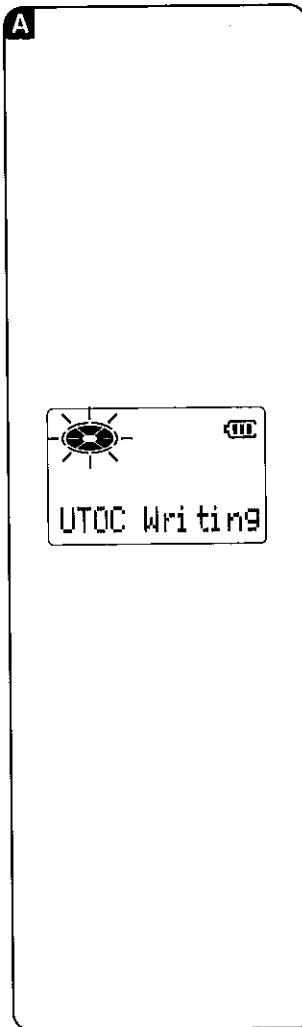

Recording

■ Adding track marks

Digital recording

● When recording from CD

The track marks are put onto the MD as they are found on the CD. Each time a new track starts on the CD, the number of the tracks on the MD increases by one. (Track marks may not be inserted accurately in some cases.)

● When recording from digital sources other than CDs

2 seconds of silence is determined as the division between tracks and a track mark is added.

To add track marks manually

Analogue recording

2 seconds of silence is determined as the division between tracks and a track mark is added.

To add track marks manually

Note

Track marks will not be added if the space between tracks is short or if there is noise in the space. Track marks may be added in error if there is a silent or especially quiet portion in a track. Use the editing functions after recording to add and remove track marks.

Recording with the microphone

Add track marks manually or have the unit add the marks at selected intervals.

■ Making good recordings

Power the unit with the AC adaptor while recording. If you intend to use batteries, recharge the rechargeable battery fully and use a new dry cell battery.

● If the unit turns off while recording, or when "UTOC Writing" is on the display ("WRITE" on the remote control), the recording will not be correctly recorded onto the disc.

● "DISC ERROR" may appear on the display if the unit turns off while "UTOC Writing" is on the display.

Recording

Do not open the lid or shake the unit while recording.

Be especially careful while "UTOC Writing" is on the display ("WRITE" on the remote control). If the unit is moved at this time, the recording may not be correctly recorded onto the disc. You can damage the unit or disc if you try to force open the lid.

Note

● This unit has a sampling rate converter so recording from equipment (DAT deck, BS tuner, etc) with a different sampling frequency is possible.

● Insert the rechargeable battery when recording on dry cell batteries.

(For United Kingdom)

Your attention is drawn to the fact that recording pre-recorded tapes or discs or other published or broadcast material may infringe copyright laws.

A

1

EDIT

MARK MODE

2

A

CHARA

B

SUB

B

A

ENTER

B

SUB

+

Other recording functions

Ways of adding track marks

A

Apart from auto mark mode where the unit automatically adds the track marks during recording, there are also the manual and time mark mode methods.

1 Press [EDIT, MARK MODE] while the unit is in the recording standby mode to select the required marking mode.

The mode changes each time the button is pressed.

AUTO
Track marks are added automatically when the track changes.

MANUAL

Track marks can be added manually where required.

3 MIN

Track marks inserted at 3 minute intervals.

5 MIN

Track marks inserted at 5 minute intervals.

10 MIN

Track marks inserted at 10 minute intervals.

2 Press [▶/II, CHARA] (main unit) or the main button (remote control) to start recording.

- Ⓐ Main unit
- Ⓑ Remote control
- ♪: Beep

■ To add track marks manually

B

Press the jog dial (main unit) or [VOL +, EQ, T.MARK] (remote control) when a track mark is required.

- Ⓐ Main unit
- Ⓑ Remote control
- ♪: Beep

Track marks are added even if "MANUAL" has not been selected.

Note

"AUTO" cannot be selected when recording with a microphone.

A

EQ/REC SENS

SPACE

DISPLAY

CAPS LOCK

SUB

B

1

0:0

a

b

c

B

EQ/REC SENS

SPACE

(REC SENS L)

(REC SENS H)

Other recording functions

Checking the remaining time on the MD

This function allows you to check the time available for recording before you start recording or while recording is in progress.

Press [DISPLAY, CAPS LOCK] (main unit) or press and hold [▶], [LIGHT = DISP] (remote control) while in recording standby mode or during recording.

- Ⓐ Main unit
- Ⓑ Remote control
- ♪: Beep

The display changes each time this is done to show elapsed recording time and the remaining recording time.

- Ⓐ Number of track recording
- Ⓑ Elapsed recording time
- Ⓒ Available time for recording

Adjusting recording sensitivity

You can adjust the sensitivity of the unit for analogue recording.

Press [EQ/REC SENS, SPACE] while in recording standby mode.

The mode changes each time the button is pressed.

REC SENS L ↔ REC SENS H

REC SENS L:

To record from stereos and radio cassette players

REC SENS H:

To record from portable equipment

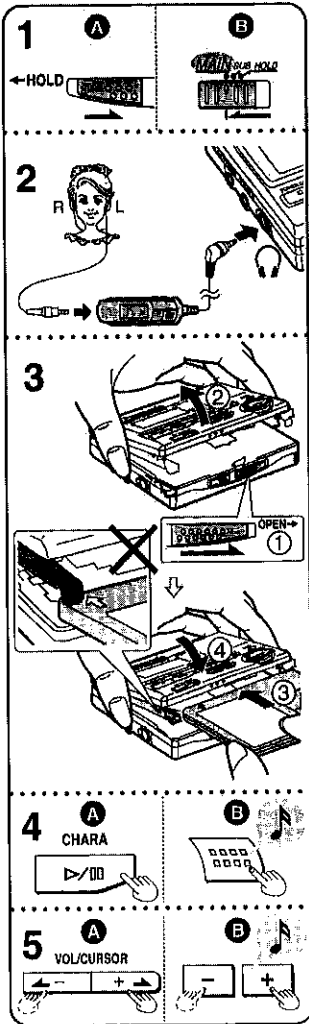

Playback (Basic play)

1 Release the hold function.

- Ⓐ Main unit
- Ⓑ Remote control

2 Connect the earphones to the remote control then insert the remote control's plug into the headphone jack (Ⓜ) on the player. (Plug in firmly.)

3 Open the player and insert an MD.

- ① Slide [OPEN] to the right.
- ② Open the lid.
- ③ Insert disc with label facing upward. Push the disc in the center until it locks in place.
- ④ Close the lid.

After an MD has been inserted the player turns on, reads the information from it, then, after a minute, the power goes off again. The name of the disc or song is shown on the display. The information scrolls from right to left across the display if it can not be displayed all at once.

("NO TITLE" (main unit) or "-- --" (remote control) is displayed when the disc contains no track or disc titles.)

4 Press [▶/||, CHARA] (main unit) or the main button (remote control) to start play.

- Ⓐ Main unit
- Ⓑ Remote control

♪: Beep

The player stops automatically when all the tracks on the disc have been played.

5 Adjust the volume.

- Ⓐ Main unit
- Ⓑ Remote control

♪: Beep

+: To increase the volume level

-: To decrease the volume level

Volume range is 0-25.

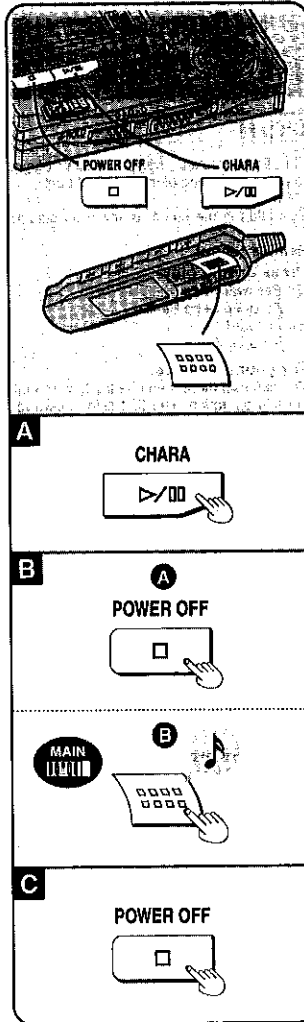

Playback (Basic play)

■ To pause play [⏸]

Press [▶/||, CHARA] (main unit) during play. Playback restarts when pressed again.

■ To stop the disc [⏹]

Press [■, POWER OFF] (main unit) or the main button (remote control) during play.

- Ⓐ Main unit
- Ⓑ Remote control

The unit powers itself off automatically in about a minute.

■ To turn the unit off [⏹]

Press [■, POWER OFF] (main unit) while stopped.

■ Resume function

The player stores the point at which play was stopped and if [▶/||, CHARA] on the main unit or the main button on the remote control is pressed again, play begins from that point. This does not work if the player is opened or if the battery is removed. The player starts play from the first track in these cases.

■ Monaural playback

If a disc was recorded monaurally, the unit automatically switches to monaural playback mode. ("MONO" appears on the main unit's display.)

Note

● If the display on the remote control disappears or seems unusual, disconnect the remote control then plug it in again firmly.

● This unit is vibration resistant but sound may skip if the vibration is constant.

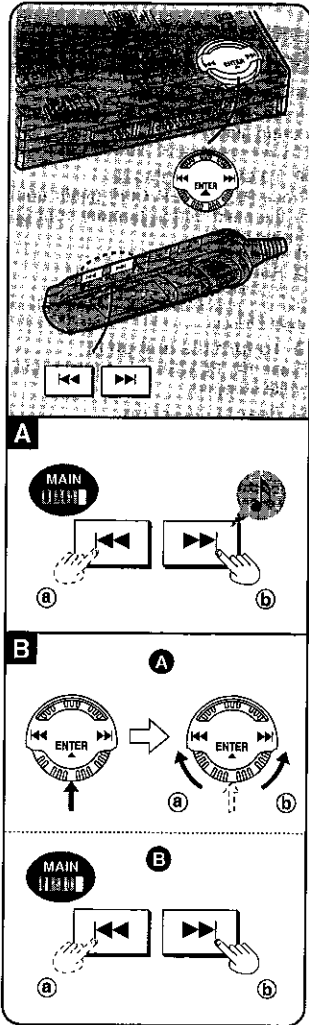

Other playback functions

Skip

This function skips tracks and play begins from the beginning of the selected track.
Main unit
 Operation is the same as for "Title search"

Remote control

- Press during play.**
- Ⓐ Backward
♪: Beep Beep Beep
 - Ⓑ Forward
♪: Beep Beep

For your reference:

You can skip more than one track by repeating this operation. The first skip backwards takes you to the beginning of the current track. Pressing the button in quick succession takes you back to previous tracks.

Search

This function allows you to fast-forward or rewind through tracks.

Main unit
 During play, press and turn the jog dial.

- Ⓐ Backward
- Ⓑ Forward

Playback resumes when you release the dial.

Remote control

Hold down during play.

- Ⓐ Backward
- Ⓑ Forward

For your reference:

- You cannot fast-forward past the end of the last track. If you release the button at this point, the player stops.
- You cannot rewind beyond the beginning of the first track. The player starts playing the first track if the button is released at this point.

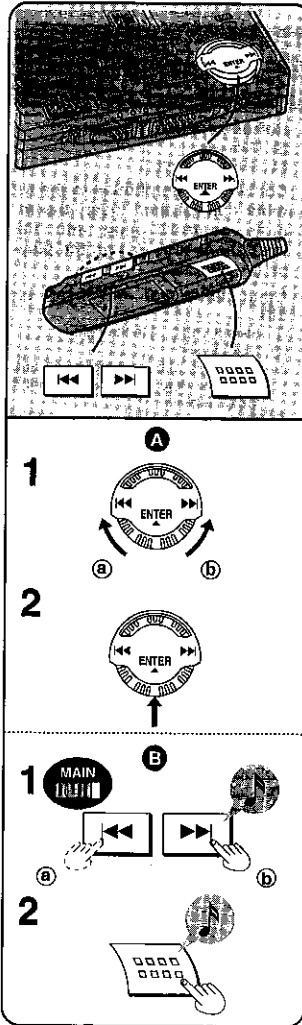

Other playback functions

Title search

This function allows you to begin listening from a selected track.

Main unit

1 Turn the jog dial to select the track while stopped or during play.

- Ⓐ Backward
- Ⓑ Forward

Track name and track number appear on the display.

After about 5 seconds (or when the title finishes scrolling if it takes more than 5 seconds) the previous display is restored.

2 Press the jog dial to play the specified track.

Remote control

1 Select a track by pressing while stopped.

- Ⓐ Backward
♪: Beep Beep Beep
- Ⓑ Forward
♪: Beep Beep

2 Press the main button.

- ♪: Beep

For your reference:

- You can hold the button of the remote control in place to go through tracks.
- If [ENTER] on the remote control is pressed or the jog dial on the main unit is turned left while the first track is selected then the last track is selected.
- If [ENTER] on the remote control is pressed or the jog dial on the main unit is turned right while the last track is selected then the first track is selected.

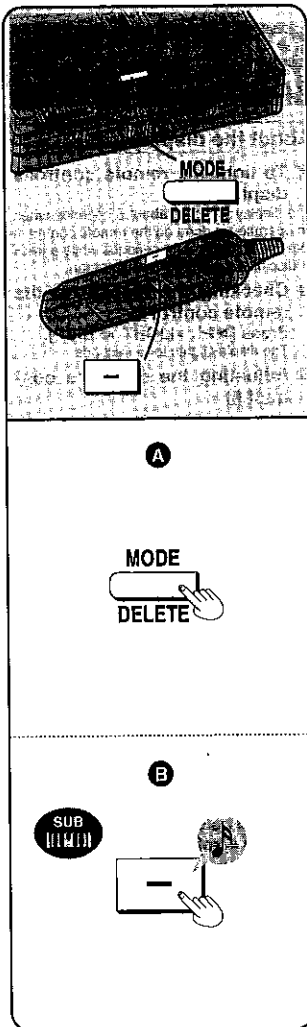

Other playback functions

Repeat and Random play

Press [MODE, DELETE] (main unit) or [VOL -, PLAY MODE, REC PAUSE] (remote control) when the player is stopped or playing.

- Ⓐ Main unit
- Ⓑ Remote control

Every time the button is pressed the mode changes and an indicator is shown on the display in the following order.

1 track repeat (1-↺)
One track is played over and over.

All track repeat (↻)
All tracks on the disc are repeated.

Random (RANDOM, RND)
All tracks are played randomly once each then the player stops automatically.

Normal (no indicator is shown)

Note
If you have selected the mode while stopped, press [▶/⏸, CHARA] (main unit) or the main button (remote control) to start playback.

- For your reference:**
- When the player is in the all-track repeat mode, you can skip (on the remote control) and search beyond the first and last track.
 - You cannot skip or search back to a track that has already been played when in random mode.
 - If you specify a track with the main unit during random play, random play begins again from that track.
 - The modes are cleared after changing discs.

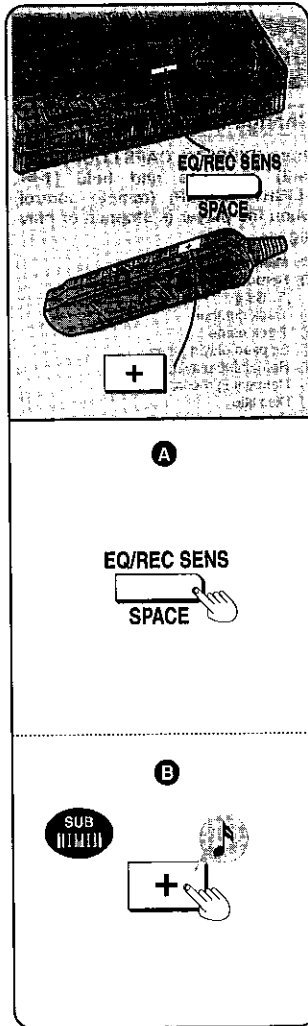

Other playback functions

Sound quality

Press [EQ/REC SENS, SPACE] (main unit) or [VOL +, EQ, T.MARK] when the player is stopped or playing.

- Ⓐ Main unit
- Ⓑ Remote control

Every time the button is pressed the mode changes in the following order.

S-XBS
Increases the power of the bass sounds.

TRAIN
Reduces sounds that may annoy others when you are using the player in a public place.

Normal (no indicator is shown)

Note
If you selected the mode when stopped, press [▶/⏸, CHARA] (main unit) or the main button (remote control) to start playback.

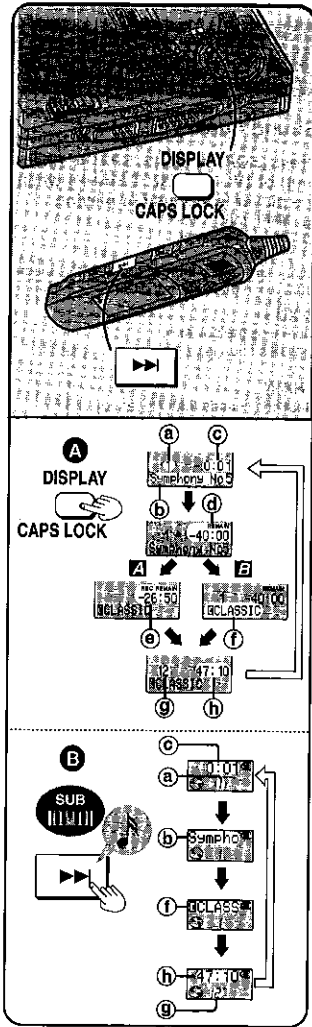

Other playback functions

Change the display

Press [DISPLAY, CAPS LOCK] (main unit) or press and hold [▶▶], •LIGHT = DISP] (remote control) when the player is stopped or playing.

- Ⓐ Main unit
- Ⓑ Remote control
- Ⓐ Beep
- Ⓐ Track number
- Ⓑ Track name
- Ⓐ Elapsed playing time
- Ⓑ Remaining playing time
- Ⓐ Remaining recording time
- Ⓑ Disc title
- Ⓐ Total number of tracks
- Ⓑ Total playing time

- Ⓐ While stopped
- Ⓑ While playing

♣ Changes each time the button is pressed
 ◇ Changes automatically after a few seconds
 ("NO TITLE" (main unit) or "----" (remote control) is displayed when the disc contains no track or disc titles.)

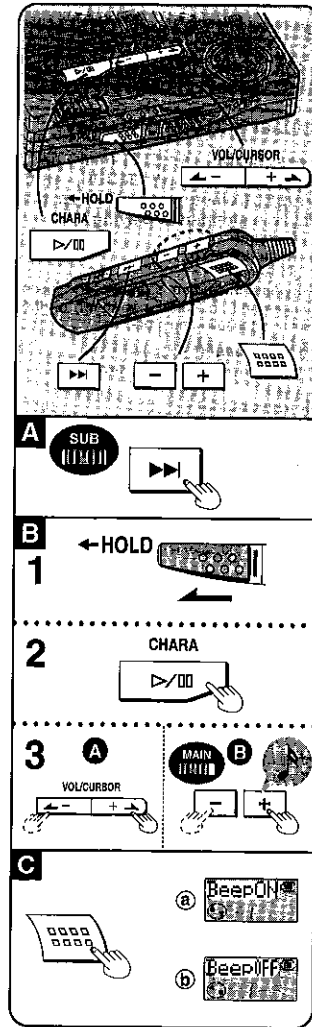

Other useful functions

About the display

■ To light the remote control's display

The display lights for about 5 seconds when an operation is done on the remote control. It remains lit for up to 20 seconds while a track or disc title is scrolling on the screen.

■ Checking the display of the remote control

Press [▶▶], •LIGHT = DISP]. The display lights for 5 seconds.

■ Adjusting the display's contrast

1 Turn the unit on and put it in hold.

2 Press and hold [▶▶/II, CHARA] on the main unit and...

3 Press [---, +--, VOL/CURSOR] (main unit) or [VOL +, EQ, T.MARK] or [VOL -, PLAY MODE, REC PAUSE] (remote control).

- Ⓐ Main unit
- Ⓑ Remote control
- ♣ Beep
- + : darker, - : lighter

The operation tone of the remote control

A tone sounds when a button on the remote control is pressed.

The tone can be turned on and off.

Press and hold the main button until following display appears.

- Ⓐ To turn on
- Ⓑ To turn off

Note

If the above is done during play, play stops and power automatically goes off in about 1 minute.

Editing MDs

MOVE (Moving tracks)

Rearrange the order of the tracks. The new order is recorded onto the MD so the tracks are always played in the order.

- 1 Press [EDIT, MARK MODE] while stopped.
- 2 ① Turn the jog dial to select "MOVE?".
② Press it.
Now the display is in the mode to select track to be moved.
- 3 ① Turn the jog dial to select the track to be moved.
ⓐ Track number decreases
ⓑ Track number increases
② Press it.
ⓒ Track being moved
ⓓ New position
Now the display is in the mode to select the new position.
- 4 ① Turn the jog dial again to select the new position.
ⓐ Track number decreases
ⓑ Track number increases
② Press it.
The display asks you to confirm your selection.
- 5 Press [EDIT, MARK MODE].
When "UTOC Writing" goes out editing is complete and the unit stops.

To stop part way through an editing operation
Press [■, POWER OFF] before confirming the operation in step 5.

Editing MDs

■ When performed while playing or paused

- 1 Press [EDIT, MARK MODE] while the track you want to move is playing or paused.
- 2 ① Turn the jog dial to select "MOVE?".
② Press the jog dial.
- 3 ① Turn the jog dial to select the new position.
② Press the jog dial.
The display asks you to confirm your selection.
- 4 Press [EDIT, MARK MODE].
When "UTOC Writing" goes out editing is complete and the unit stops.

ERASE (Erasing tracks) □

Erase one track at a time with TRACK ERASE, or erase all the tracks on the MD with ALL ERASE. When tracks are erased with TRACK ERASE, the tracks following move back to fill in the space and the number of tracks reduces by one each time the operation is performed.

ALL ERASE

- 1 Press [EDIT, MARK MODE] while stopped.
- 2 ① Turn the jog dial to select "ALL ERASE?".
② Press it.
The display asks you to confirm your selection.
- 3 Press [EDIT, MARK MODE].
When "UTOC Writing" goes out editing is complete and the unit stops.
("BLANK DISC" appears on the display.)

To stop part way through an editing operation
Press [■, POWER OFF] before confirming the operation in step 3.

Note
ALL ERASE cannot be used while the disc is playing or paused.

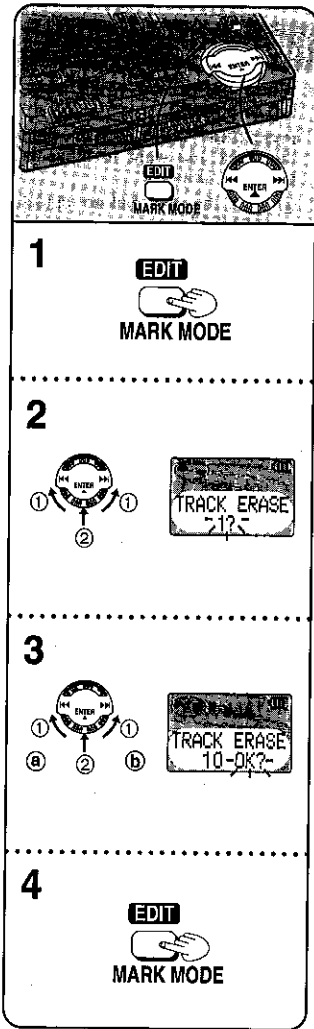

Editing MDs

TRACK ERASE

- 1 Press [EDIT, MARK MODE] while stopped.
- 2 ① Turn the jog dial to select "TRACK ERASE?".
② Press it.
Now the display is in the track selection mode.
- 3 ① Turn the jog dial to select the track to erase.
ⓐ Track number decreases
ⓑ Track number increases
② Press it.
The display asks you to confirm your selection.
- 4 Press [EDIT, MARK MODE].
When "UTOC Writing" goes out editing is complete and the unit stops.

To stop part way through an editing operation

Press [■, POWER OFF] before confirming the operation in step 4.

When performed while playing or paused

- 1 Press [EDIT, MARK MODE] while the track you want to erase is playing or paused.
- 2 ① Turn the jog dial to select "TRACK ERASE?".
② Press the jog dial.
The display asks you to confirm your selection.
- 3 Press [EDIT, MARK MODE].
When "UTOC Writing" goes out editing is complete and the unit stops.

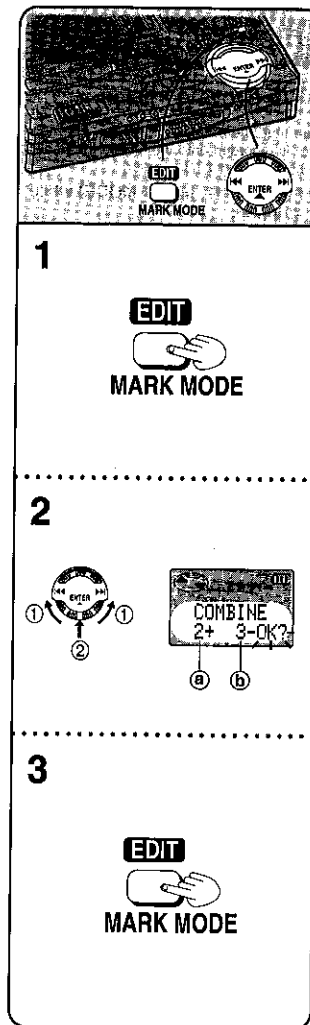

Editing MDs

COMBINE (Combining 2 tracks)

Remove a track mark from between two tracks, effectively making them one track. (If you combine tracks 2 and 3, for example, the track will take the number 2 and also retain the title for track 2.)

- 1 Press [EDIT, MARK MODE] while playing the latter of the two tracks you want to combine (or while paused).
- 2 ① Turn the jog dial to select "COMBINE?".
② Press it.
ⓐ track before
ⓑ track playing
The display asks you to confirm your selection. In the example, the last eight seconds of track 2 and the first eight seconds of track 3 play repeatedly.
- 3 Press [EDIT, MARK MODE].
When "UTOC Writing" goes out editing is complete and the unit stops.

To stop part way through an editing operation

Press [■, POWER OFF] before confirming the operation in step 3.

When performed while stopped

- 1 Press [EDIT, MARK MODE] while the disc is stopped.
- 2 ① Turn the jog dial to select "COMBINE?".
② Press the jog dial.
Now the display is in the mode to select the tracks to be combined.
- 3 ① Turn the jog dial to select the two tracks to combine.
② Press the jog dial.
- 4 Press [EDIT, MARK MODE].
When "UTOC Writing" goes out editing is complete and the unit stops.

Note

- COMBINE does not work while playing track 1.
- You cannot combine a track recorded normally and a track recorded monaurally.

Editing MDs

DIVIDE (Dividing a track into two)

This allows you to add track marks, making it easy to divide a classic piece into its separate movements, for example.

- 1 Press [EDIT, MARK MODE] while playing the track you want to divide.
- 2 ① Turn the jog dial to select "DIVIDE?".
② Press it at the point you want to divide the track.
A 4 second segment (8 seconds if track is monaural) of the track is played repeatedly, beginning at the point selected.

To adjust the point

Turn the jog dial to adjust the point. Adjustments can be made approximately 8 seconds (16 seconds if track is monaural) either side of the original point. (-128 to +127)

- 3 Press the jog dial.
The display asks you to confirm your selection.

- 4 Press [EDIT, MARK MODE].
When "UTOC Writing" goes out editing is complete and the unit stops.

To stop part way through an editing operation
Press [■, POWER OFF] before confirming the operation in step 4.

Note

- If you divide a track with a title, the latter track becomes untitled.
- DIVIDE cannot be used while the unit is stopped.

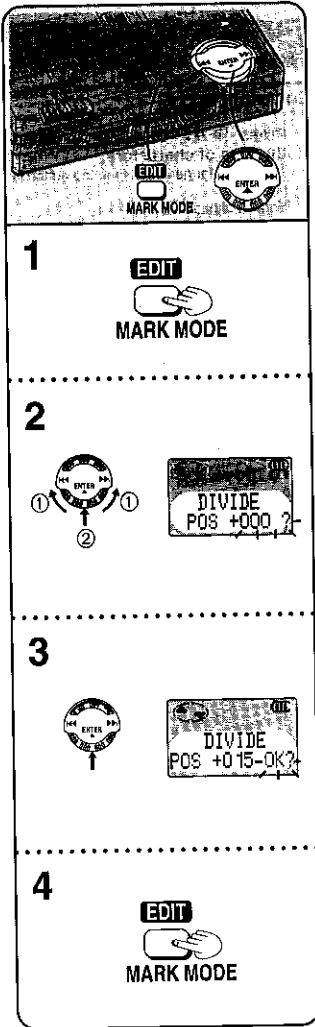

Titling MDs

Titling discs and tracks

Tracks and discs can have a titles up to 100 characters long.

- 1 Press [EDIT, MARK MODE] while stopped.
"TITLE?" appears on the display.
- 2 A When titling a disc
① Press the jog dial.
"DISC TITLE?" appears on the display.
② Press it again.
The text editing mode is entered.
B When titling a track
① Press the jog dial.
"DISC TITLE?" appears on the display.
② Turn it to select the track you want to title.
③ Press the jog dial.
The text editing mode is entered.
- 3 Enter the title. (See page 62.)
- 4 Press [EDIT, MARK MODE].
When "UTOC Writing" goes out editing is complete.

After titling a disc

The display automatically shows the track titling display. Follow the steps for titling tracks.

To stop part way through an editing operation

Press [■, POWER OFF].
The normal display is restored.

Note

If you start entering a title while a track is playing, the track repeats until you finish.

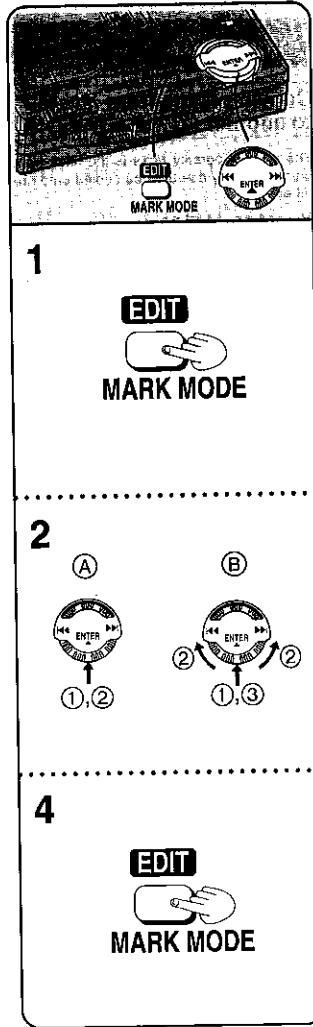

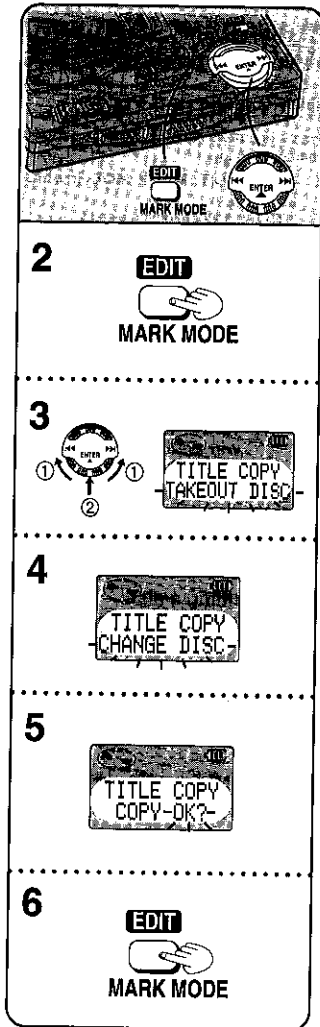

Titling MDs

Copying a title from one MD to another (TITLE STATION)

The unit temporarily records the titles from an MD so they can then be copied onto another MD.

Before proceeding

- You cannot copy titles from prerecorded MDs.
- You can copy the title only if both MDs have the same number of tracks.
- Any titles on the second MD are replaced when this function is used.

- 1 Insert the MD with the title.
- 2 Press [EDIT, MARK MODE] while stopped.
- 3 ① Turn the jog dial to select "TITLE COPY?".
② Press it. "TAKEOUT DISC" is displayed when the unit has recorded the title.
- 4 Eject the MD. "CHANGE DISC" is displayed when the lid is opened.
- 5 Insert the other MD. After "TOC Reading" is displayed, the display asks you to confirm the operation.
- 6 Press [EDIT, MARK MODE]. When "UTOC Writing" goes out editing is complete and the unit stops.

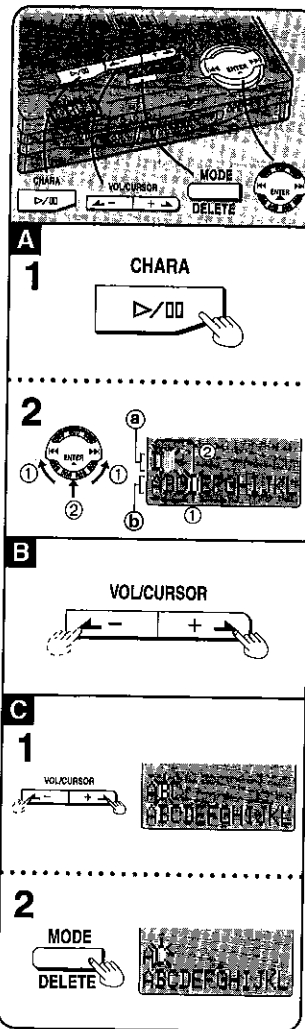

Titling MDs

Entering text

- 1 Press [▶/||, CHARA] to select the type of characters. The type changes each time the button is pressed.

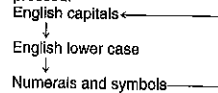

- 2 ① Turn the jog dial to move the cursor over the character you want to enter.
② Press it to enter the character.
③ Entered text
④ Characters
The character you selected is entered. The cursor moves to the right and shows where the next character will be entered.
- To move the cursor []
Press [←, →, VOL/CURSOR].
+ →: right
- ←: left
- To erase a character []
1 Press to move the cursor over the character you want to erase.
2 Press [MODE, DELETE].
The characters after the erased character move back to take its place.

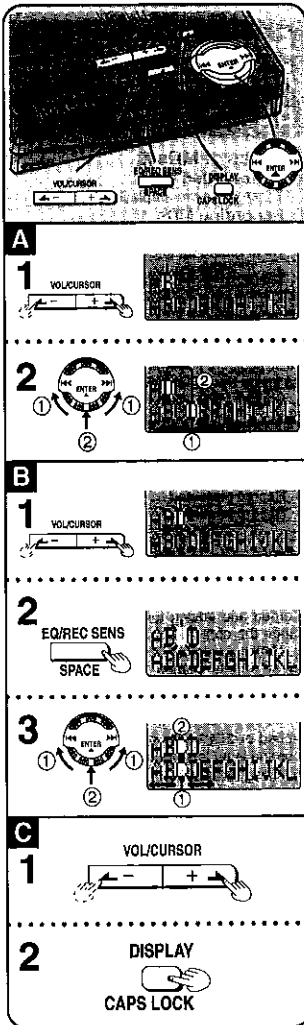

Titling MDs

■ **Correcting titles** [A]

- 1 Press [←, →, VOL/CURSOR] to move the cursor over the character you want to correct.
- 2 ① Turn the jog dial to move the cursor over the character you want to enter.
② Press it to enter the character. The new character replaces the old one.

■ **To insert an extra character** [B]

- 1 Press [←, →, VOL/CURSOR] to move the cursor over the place you want the character to go.
- 2 Press [EQ/REC SENS, SPACE].
- 3 ① Turn the jog dial to select the character to enter.
② Press it to enter the character. The character is inserted.

■ **Changing capitals into lower case or lower case into capitals** [C]

- 1 Press [←, →, VOL/CURSOR] to move the cursor over the character you want to change.
 - 2 Press [DISPLAY, CAPS LOCK].
- **To exit the text editing mode part way through**
Press [■, POWER OFF].
The normal display is restored.

Titling MDs

■ **Characters available for titles.**

ABCDEF GHIJKL MNOPQRST UVWXYZ
abcdefghijklmnopqrstuvwxyz
0123456789 !"#\$%&'()*+,-./:;<= >?@_`^

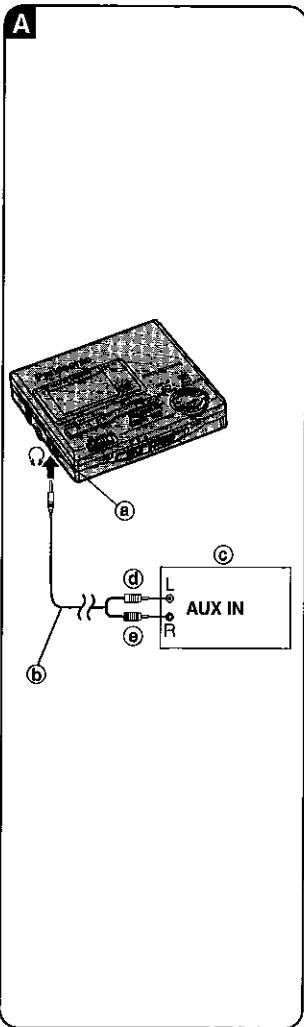

Using the unit with optional accessories

- Read the operating instructions of the items to be used.
- Use the recommended accessories to ensure correct operation.

■ Connection to a stereo system

You can listen to or record the sound from this unit on other audio equipment. Disconnect the earphones from the remote control and connect the stereo equipment with one of the following line cords.

■ If the amp's connection is:

■ a line connection:

Use the included line cord.

■ a mini-phone jack:

Obtain the optional line cord.

④ Headphone jack

⑤ Line cord

⑥ Amplifier

⑦ (white)

⑧ (red)

- Turn off the power to all units before making connections.

- Either turn the remote control's operation tone off or perform the operations on the main unit.

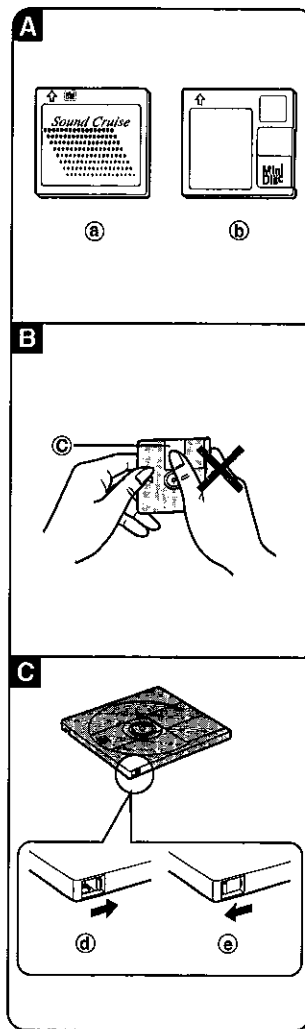

Some useful information about MDs

■ Types of MDs

① Prerecorded MDs

These discs are for playback only.

② Recording MDs

Apart from the time limitations, it is possible to record up to 254 tracks on an MD.

■ Care and storage

Label MDs only as recommended. Extra labels and exposed adhesive can cause malfunctions.

Do not open the shutter. Close it immediately if it accidentally opens. Never touch the disc inside the MD cartridge.

③ Shutter

■ Protecting your recordings

Move the switch to open the write protect hole. Close the hole when you want to record or edit the MD again.

④ Record protected

⑤ Record enabled

■ Recording MDs

MDs are different to tapes

MDs give you control over how tracks are recorded and editing functions allow you to change the contents of an MD after recording. Unlike cassettes, it is not necessary to find an empty portion to record onto. All recordings start from the first available space. The MD fills up and when the disc is full, either because the time limit has been reached or 254 tracks have been recorded, recording is no longer possible. You can use the editing functions to erase and move your recordings around within the MD.

■ Limitations on digital recording

The serial copy management system (SCMS) prevents unlimited recording of digital material.

Digital recordings are of high quality, but to protect the rights of the producer of the original material, it is only possible to make one digital recording of a digital recording. This also applies if you record analogue material digitally. That digital recording can be recorded digitally once more, but is blocked after that.

Analogue recordings are otherwise unaffected.

■ Glossary of terms

TOC

Table of contents. Information stored on the MD about the tracks and times.

UTOC

User table of contents. This is information the user can edit, such as text and track positions.

The message "UTOC Writing" appears on the display after recording and editing.

Troubleshooting guide

Before requesting service for this unit, check the chart below for a possible cause of the problem you are experiencing. Some simple checks or a minor adjustment on your part may eliminate the problem and restore proper operation. If you are in doubt about some of the check points, or if the remedies indicated in the chart do not solve the problem, refer to the directory of Authorized Service Centers (enclosed with this unit) to locate a convenient service center, or consult your dealer for instructions.

Blank disc inserted	<ul style="list-style-type: none"> Is the hold function on? Is a disc loaded? Is the unit completely connected to the AC power source? Have the batteries run down? Is there a problem with the disc?
Disc cannot be opened	Have you inserted a blank disc?
Disc cannot be inserted	<ul style="list-style-type: none"> Has the play mode been switched to "RANDOM" ("RND")? Did you stop the disc part way through the last time you listened to it?
Disc and track titles are incorrectly displayed or not displayed at all	<ul style="list-style-type: none"> Have you inserted a playback disc? Is the disc write protected? Is the unit correctly connected to the other equipment? Is the digital optical signal being correctly output from the other equipment?
No title	Are you using the player near a strong magnet, such as may be found in a television?
No digital audio playback, No response to either remote control	<ul style="list-style-type: none"> Has the volume been turned down too far? Have the plugs on the earphone and remote control been inserted correctly? (Try plugging it in again.) Are the plugs dirty? (Wipe away dirt on plug.)
Disc and track titles are incorrectly displayed or not displayed at all	Have you entered more text than the MD can hold? (1792 characters can be entered.)
The unit cannot be opened	Have the batteries run down, or is the unit incompletely connected to the AC power source?

Displays

BLANK DISC INSERTED	A blank disc has been inserted.
DISC CANNOT BE OPENED	The reason is shown on the lower line of the display.
DISC CANNOT BE INSERTED	The limitations of the system sometimes mean tracks cannot be combined.
DISC CANNOT BE OPENED	The limitations of the system sometimes mean tracks cannot be divided.
DISC CANNOT BE OPENED	The reason is shown on the lower line of the display.
DISC CANNOT BE OPENED	Check the digital optical fiber cable connections and try again.
DISC CANNOT BE OPENED	There is a problem with the disc and it needs to be replaced.
DISC CANNOT BE OPENED	The maximum time or number of tracks has been reached. Either erase some tracks or record with another disc.
DISC CANNOT BE OPENED	The write protect hole is open. Close it to enable recording and editing.
DISC CANNOT BE OPENED	A problem occurred during recording. Eject the MD, reinsert it and start recording from the beginning again.
MD	There is a problem with the magnetic head.
MD	The hold function is on.
LOW BATT (LV BATT)	The batteries have run down.
NO DISC IN CHASSIS	A disc has not been inserted.
REVERSE DISC	The disc can only be used for playback. It cannot be recorded on or edited in any way.
2ND COPY (2ND)	You are trying to make a second copy of a digital recording.
SYSTEM ERROR	The self diagnosis function has found an error.
TOC Reading (T-READ)	Reading TOC information.
TRACK NUMBER NOT EQUAL	The number of titles doesn't equal the number of titles on the target disc. Make the number equal.
TITLE FULL (FULL)	You are trying to enter the text beyond 100 characters.
UTOC FULL (FULL)	<p>The display appears for one of the following reasons:</p> <ul style="list-style-type: none"> The maximum number of tracks (254) has been reached; erase unneeded titles to make room. Due to limitations of the recording system, UTOC may become full before the maximum number of tracks or time capacity is reached. Replace the MD. The section reserved for text information is full; erase unneeded titles to make room.
UTOC WRITING (WRITE)	UTOC is recorded.

Remote control displays indicated inside [].

Maintenance

■ **If the surfaces are dirty**
To clean this unit, wipe with a soft, dry cloth.

If the surfaces are extremely dirty, use a soft cloth dipped in a soap-and-water solution or a weak detergent solution.

- Never use alcohol, paint thinner or benzine to clean this unit.
- Before using chemically impregnated cloth, read the instructions that came with the cloth carefully.

4 Handling Precautions for Traverse Deck (Mechanism Unit)

The laser diode in the mechanism unit (optical pickup) may break down due to potential difference caused by static electricity of clothes or human body. So, be careful of

electrostatic breakdown during repair of the mechanism unit (optical pickup).

4.1. Mechanism Unit (optical pickup)

1. Do not subject the mechanism unit (optical pickup) to static electricity as it is extremely sensitive to electrical shock.
2. Before you take off MD mechanism unit (optical pickup), short the short-land of the flexible P.C.B. by using a solder. (refer to Fig.1)
3. Take care not to apply excessive stress to the flexible board (FFC).
4. Do not turn the variable resistor (laser power adjustment). It has already been adjusted.

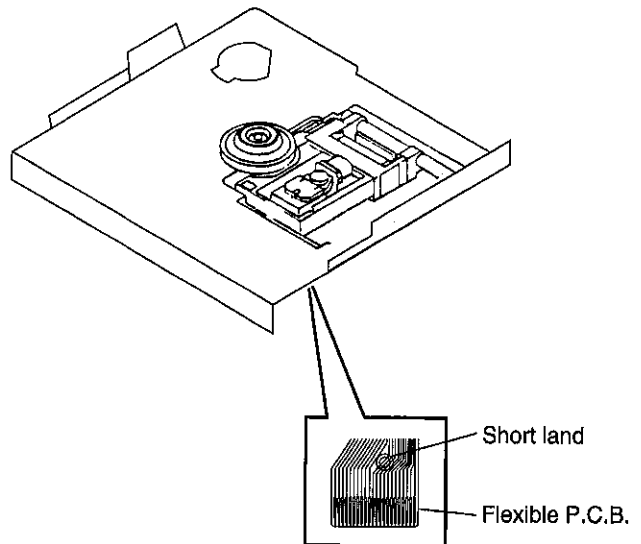

Fig. 1

4.2. Caution for repairing of MD mechanism (optical pickup)

The short-land of MD mechanism (optical pickup) as replacement part is shorted with a solder build-up. Remove the

solder after you insert the flexible P.C.B. into the connector.

4.3. Grounding for electrostatic breakdown prevention

1. Human body grounding

Use the anti-static wrist strap to discharge the static electricity from your body. (As shown in Fig. 2.)

2. Work table grounding

Put a conductive material (sheet) or steel sheet on the area where the optical pickup is placed, and ground the sheet.

Caution:

The static electricity of your clothes will not be grounded through the wrist strap. So, take care not to let your clothes touch the traverse deck (optical pickup).

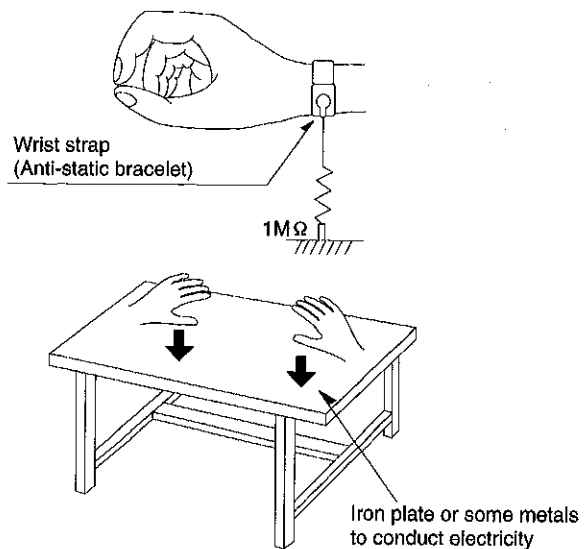

Fig. 2

5 Operation Checks and Main Component Replacement Procedures

- NOTE**
1. This section describes procedures for checking the operation of the major printed circuit boards and replacing the main components.
 2. For reassembly after operation checks or replacement, reverse the respective procedures. Special reassembly procedures are described only when required.
 3. Select item from the following index when checks or replacement are required.

● **Contents**

■ **Checking Procedures for each P.C.B.**

1. Checking for the main P.C.B..
2. Checking for the rec head P.C.B..

■ **Main Component Replacement Procedures**

1. Replacement for the LCD.
2. Replacement for the intermediate cabinet ass'y.
3. Replacement for the spindle motor ass'y.
4. Replacement for the traverse motor and lift motor.
5. Replacement for the magnetic head and optical pickup ass'y.

■ **Checking Procedures for each P.C.B.**

1. **Checking for the main P.C.B.**

⟨Checking for the main P.C.B. (A side)⟩

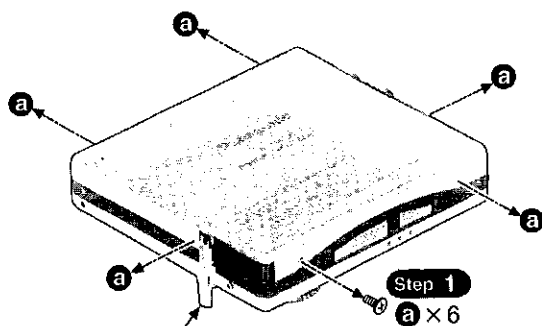

Step 2
Open the battery cover.

Step 3
Remove the cabinet ass'y.

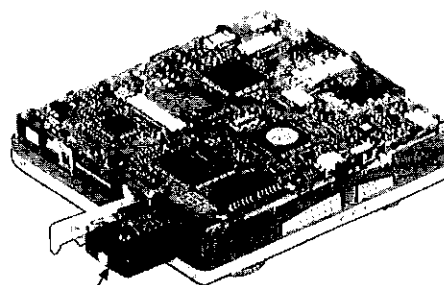
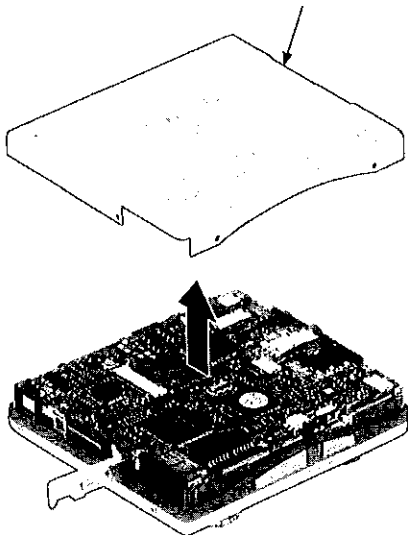

Step 4
Store the rechargeable battery, and then close the battery cover.

NOTE
The rechargeable battery should be recharged fully.

• Check the main P.C.B. (A side) as shown below.

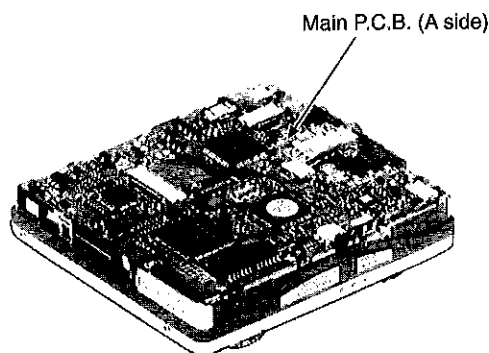

⟨Checking for the main P.C.B. (B side)⟩

• Each parts on main P.C.B. (B side) can not be checked directly, however, for the checking of main component parts on P.C.B., refer to the "Checking procedures of main components parts on the main P.C.B. (B side).

2. Checking for the rec head P.C.B.

- Follow the **Step 1** ~ **Step 4** of the item 1 in checking procedures for each P.C.B..

Step 1

Push the open knob, and then open the disc cover ass'y.

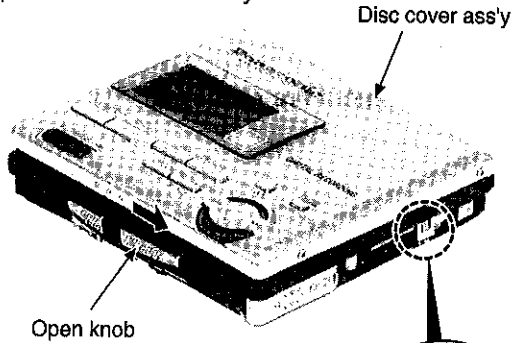

Step 2

Release the claw.

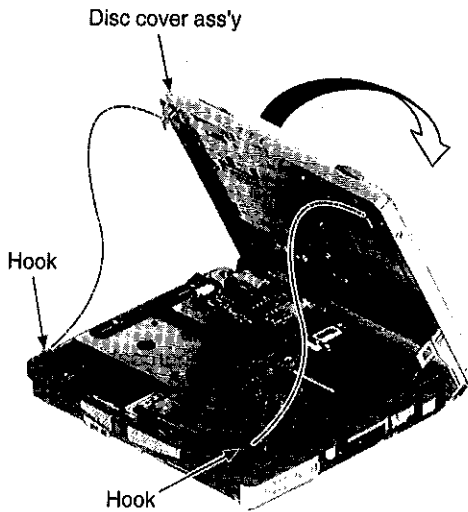
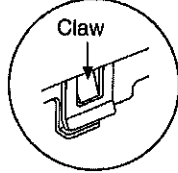

Step 3

Release the hooks of both sides, and then place the disc cover ass'y backward.

- Check the rec head P.C.B. as shown below.

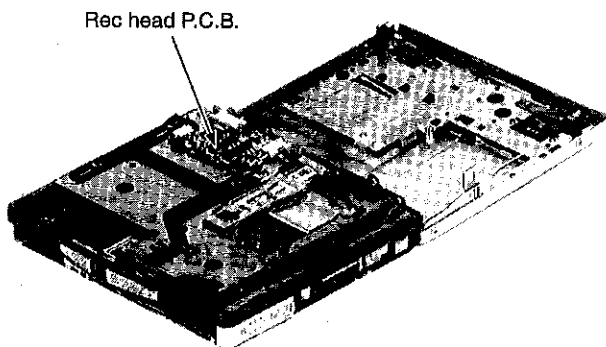

■ Main Component Replacement Procedures

1. Replacement for the LCD

- Follow the **Step 1** ~ **Step 4** of the item 1 in checking procedures for each P.C.B..
- Follow the **Step 1** ~ **Step 3** of the item 2 in checking procedures for each P.C.B..

Step 1

Remove the FFC from the connector (CN701).

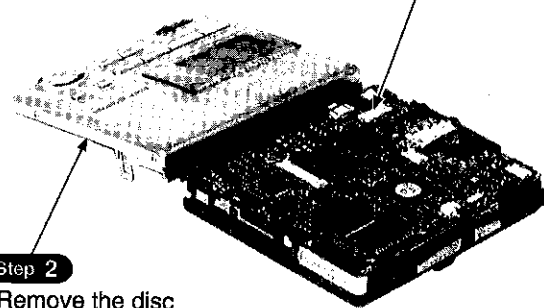

Step 2

Remove the disc cover ass'y.

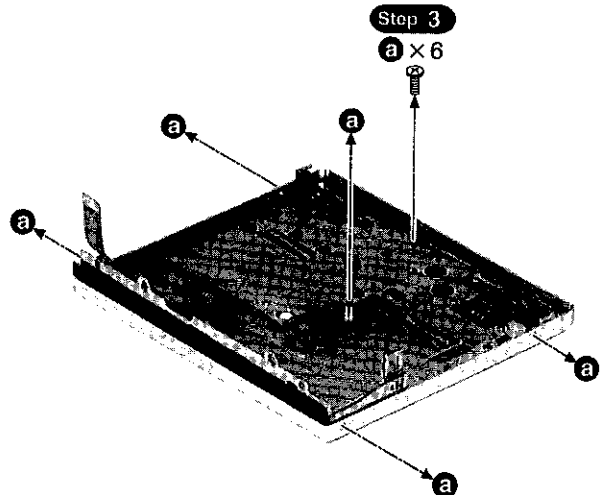

Step 4

Remove the operation P.C.B. angle.

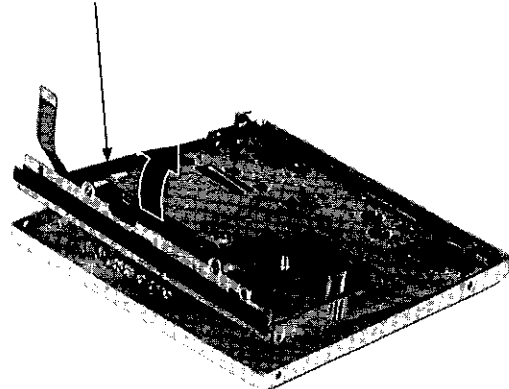

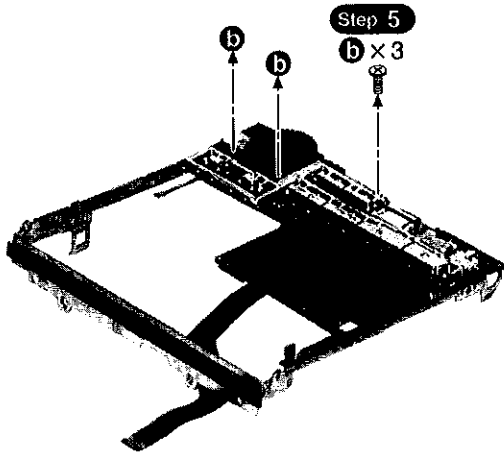

Step 5
b x 3

Step 7

Remove the FFCs from the connectors. (2 points)

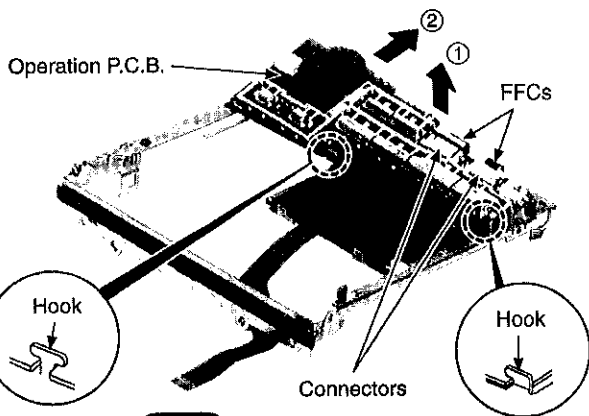

Step 6

Release the hooks, and then remove the operation P.C.B..

Step 8

Release the claw, and then remove the LCD.

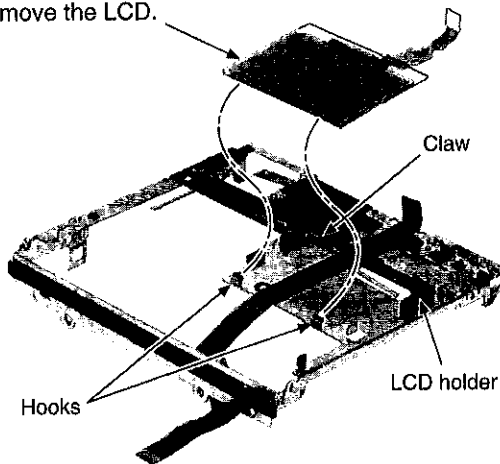

NOTE

When installing the LCD, align it with hooks, and then lock it with claw.

Notice for Installation of operation P.C.B. angle ass'y

- When installing the operation P.C.B. angle ass'y to the disc cover ass'y, locate the rec knob in the direction of arrow fully, and then align it with notch of rec lever.

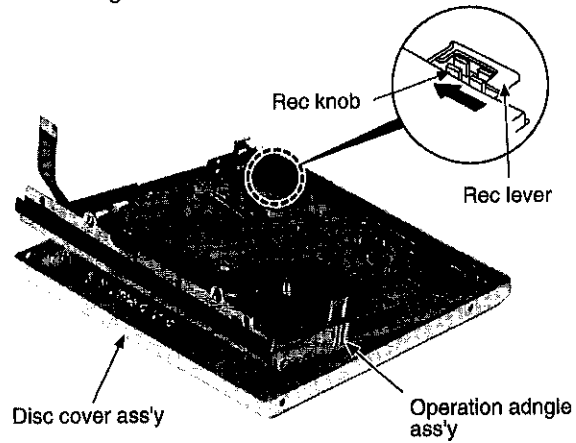

2. Replacement for the Intermediate cabinet ass'y

- Follow the Step 1 ~ Step 3 of the item 1 in checking procedures for each P.C.B..

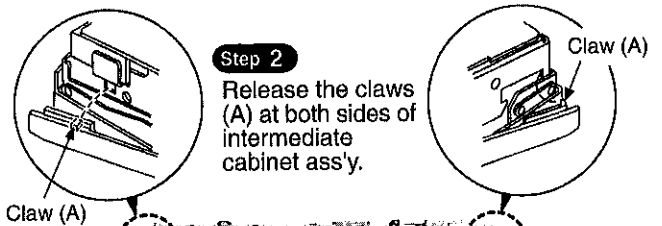

Step 2

Release the claws (A) at both sides of intermediate cabinet ass'y.

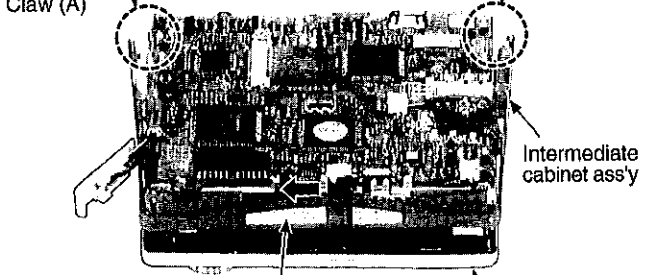

Step 1

Push the open knob, and then open the disc cover ass'y.

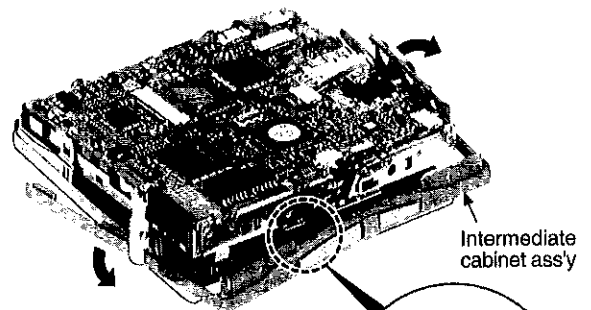

Step 3

Release the claw (B), and then remove the intermediate cabinet ass'y with spreading those both sides.

Notice for installation of intermediate cabinet ass'y

1. Align the claw of hold with the slot of hold lever.

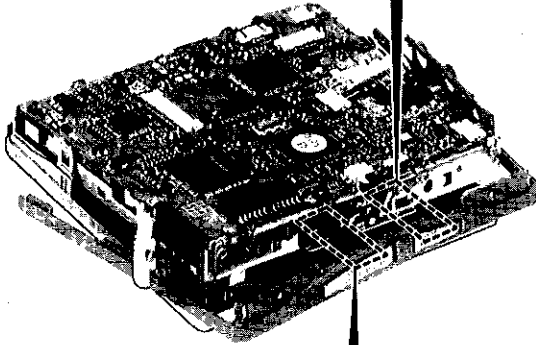
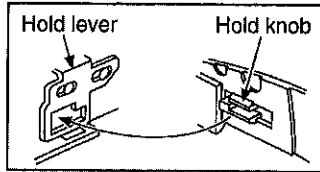

2. Align the claw of open with the slot of open lever.

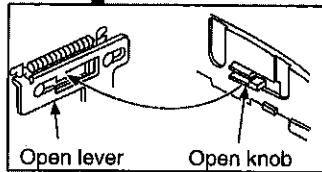

3. Replacement for the spindle motor

- Follow the **Step 1** ~ **Step 3** of the item 1 in checking procedures for each P.C.B..
- Follow the **Step 1** ~ **Step 3** of the item 2 in main component replacement procedures.

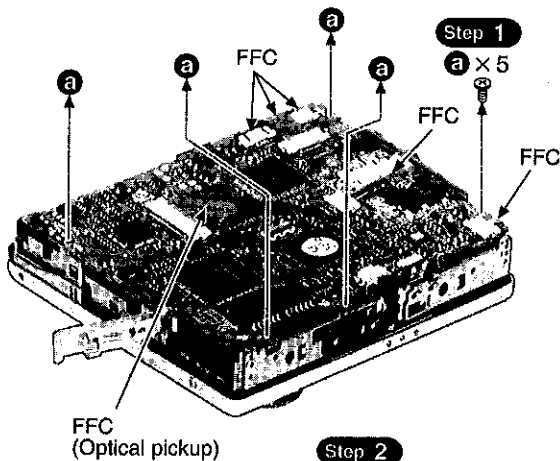

Step 2
Remove the FFC from the connectors. (6 points)

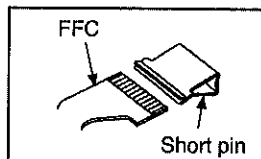

NOTE

Insert a short pin into the traverse unit FFC board. (Refer to "Handling Precautions for Traverse deck".)

Step 3

Release the claw, and lift up the main P.C.B..

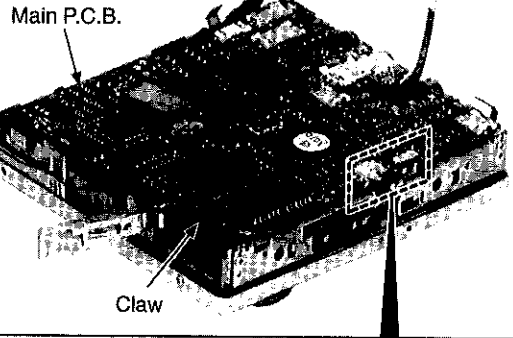

Notice of installing the main P.C.B.

- Align the boss of hold switch with the notch of hold lever.

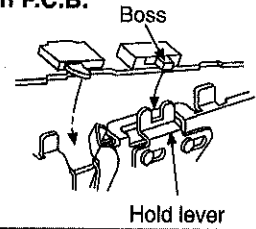

Step 4

Release the jack from the hole of chassis, and then remove the main P.C.B..

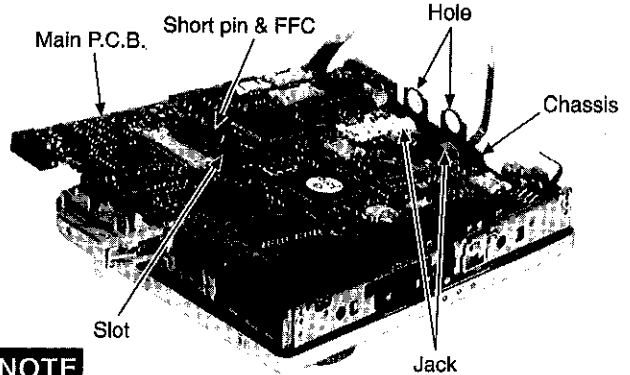

NOTE

Remove the FFC through the slot of main P.C.B. gradually to prevent damage to the surface of FFC.

NOTE

Never touch the set screws for magnetic head.

Step 5

Step 6
Remove the spindle motor.

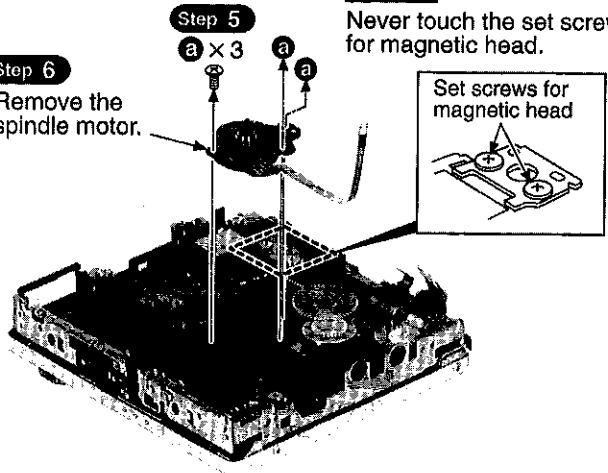

4. Replacement for the traverse motor and lift motor ass'y

- Follow the **Step 1** ~ **Step 3** of the item 1 in checking procedures for each P.C.B..
- Follow the **Step 1** ~ **Step 3** of the item 2 in main component replacement procedures.
- Follow the **Step 1** ~ **Step 4** of the item 3 in main component replacement procedures.

Step 1

Remove the washer, and then pull out the intermediate gear.

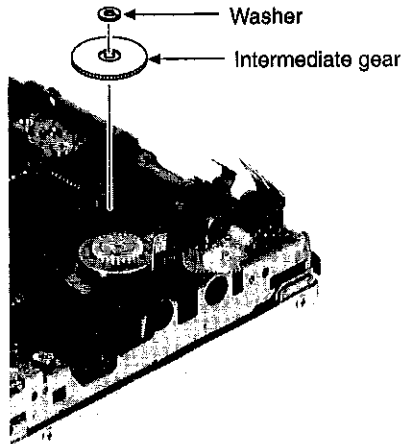

Step 2

Release the 2 claws in the direction of arrow, and then remove the drive gear (L).

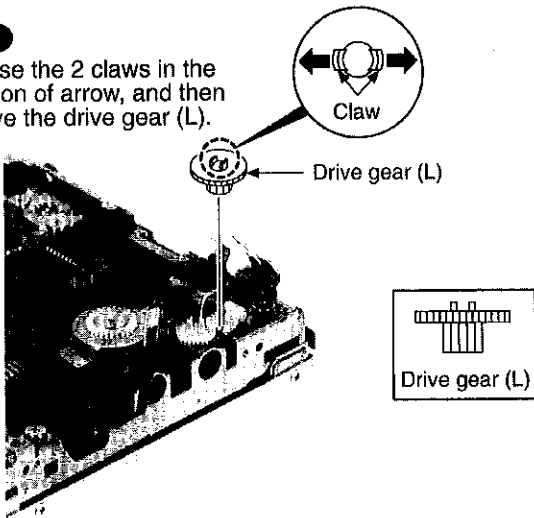

Step 3

Remove the washer, and then pull out the down gear and relay gear.

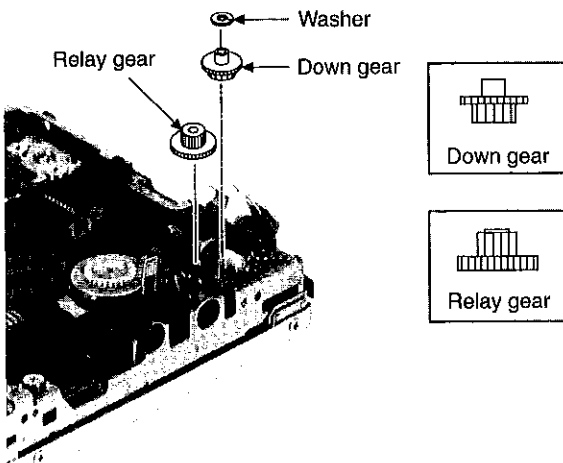

Step 4

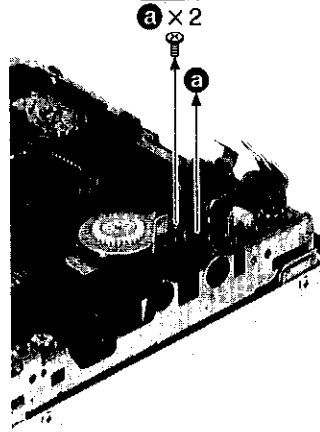

Step 5

Remove the traverse motor and lift motor ass'y.

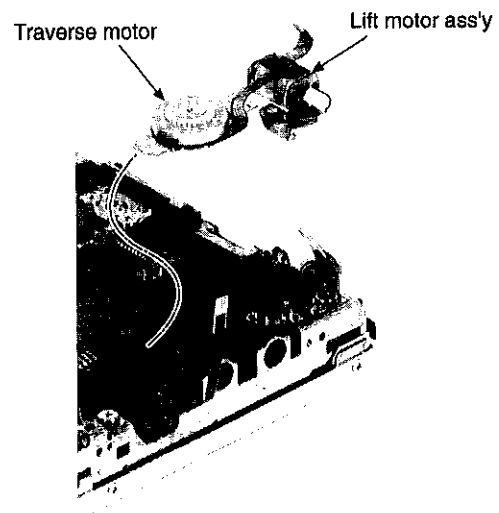

Step 6

Peel the FFC.

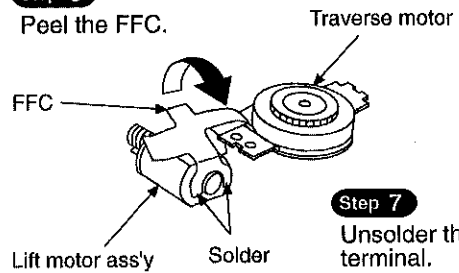

Step 7

Unsolder the lift motor terminal.

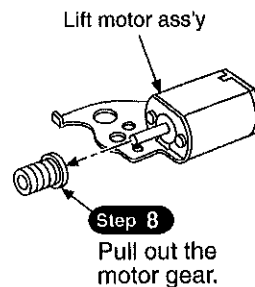

Notice for Installation motor gear

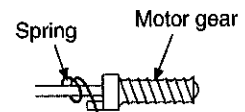

- The spring should be interfered with the end of motor gear.

Notice for installation of drive gear (L)

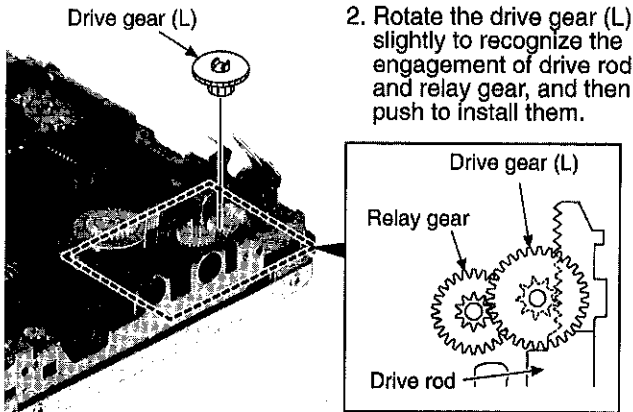
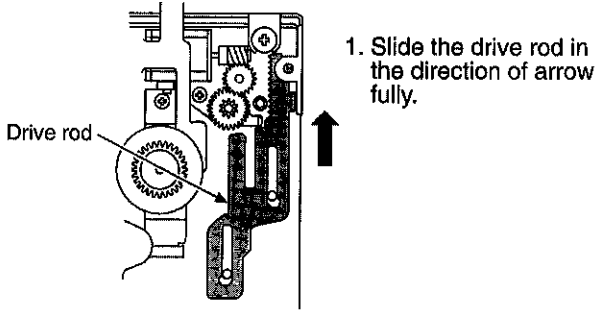

5. Replacement for the magnetic head and optical pickup ass'y

- Follow the **Step 1** ~ **Step 3** of the item 1 in checking procedures for each P.C.B..
- Follow the **Step 1** ~ **Step 3** of the item 2 in checking procedures for each P.C.B..
- Follow the **Step 1** , **Step 2** of the item 1 in main component replacement procedures.
- Follow the **Step 1** ~ **Step 3** of the item 2 in main component replacement procedures.
- Follow the **Step 1** ~ **Step 4** of the item 3 in main component replacement procedures.

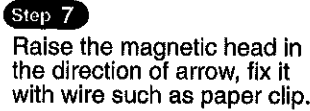
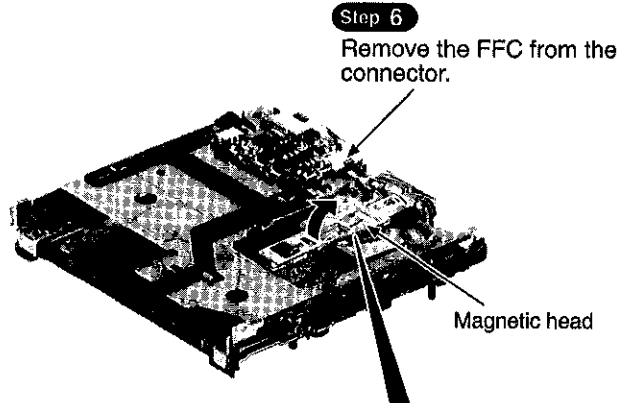
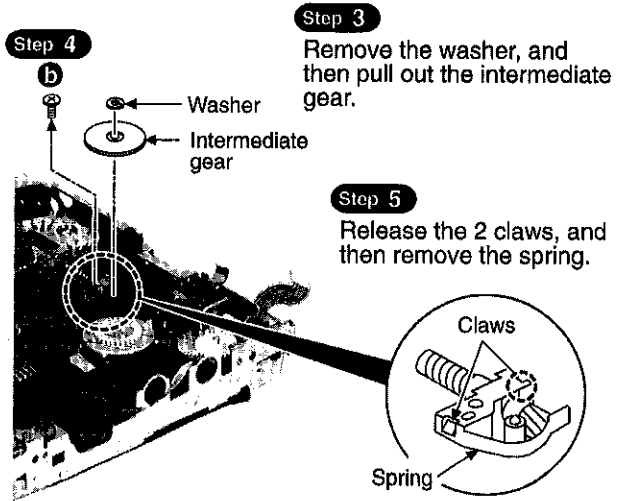
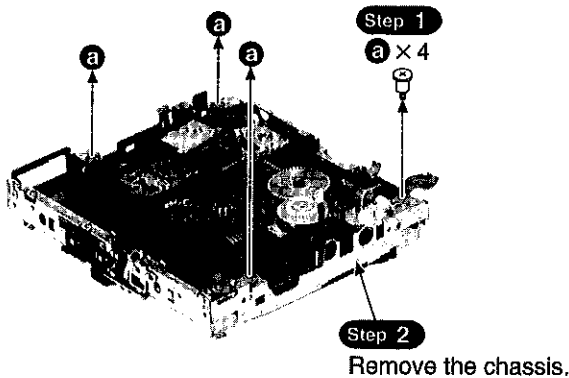

NOTE

Handle with care to the magnetic head.

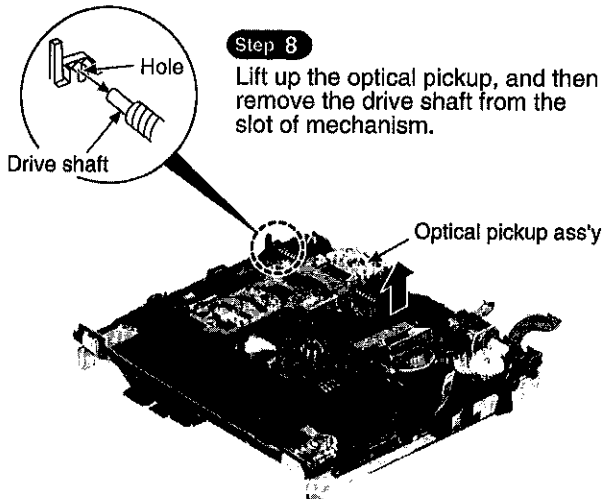

Step 9

Remove the magnetic head and optical pickup.

Set screws for magnetic head

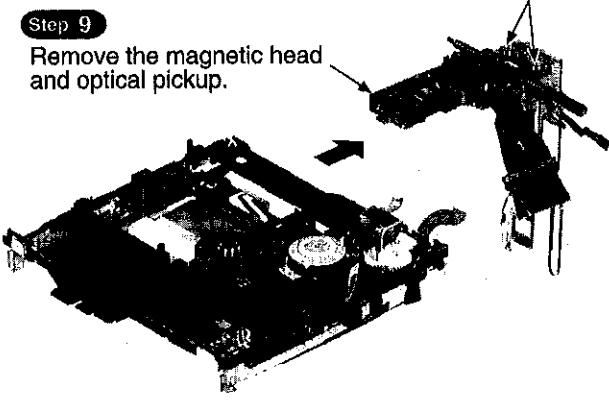
**NOTE**

1. Use care to prevent damage the optical pickup, due to the precision construction.
2. Do not touch the lens of the optical pickup.
3. Never touch the set screws for magnetic head.

6 Operating Procedures

6.1. Operating Procedures

Play

- To read the signals recorded on the disc, the laser beam emitted by the laser diode (LD) strikes the disc and is reflected back and detected by the photodetector (PD).
 - For a pre-mastered disc, similar to a CD, the signals are recorded as pits on the surface of the disc, and the signals are detected by the amount of light reflected when the laser beams strikes the pits.
 - For a recordable disc, the signals are recorded by magnetizing the magnetic film on the surface of the disc and there is no variation in the amount of light that is reflected, so the signals are detected using the shifting of the polarization of the reflected light due to the Kerr effect (*1).
- The detected signals are input to pins 38 and 39 of the RF IC (IC1), where they are amplified and then output from pin 32.
 - By observing the input signals (between pins 38 and 39) and the output signals (pin 32) on an oscilloscope, it is possible to check the eye pattern.
 - This unit SJ-MR100 makes the disc rotate double velocity, reading the signal from disc at double velocity. It has blank about 40 seconds till next reading after reading the signal once.
- Error correction of the amplified signals is performed by the MD LSI (IC101:MN66616) using EFM demodulation and ACIRC (*2) and the signals are stored in the 16M DRAM (IC102:MNA7400CWAIT). At this time, the cycle of the signals is adjusted by the LSI's clock in order to eliminate any jitter that might result from irregular revolution of the disc.
- The signals are sequentially taken from 16M DRAM (IC102) and send back to MD LSI (IC101), where they are ATRAC (*3)-decoded.

The above-mentioned items 1-4's signals are all digital.
- Digital audio signals that are outputted from MD LSI, inputted to 15pin of AD/DA converter (IC601:AK4518), converted to analog signal and outputted from 19 (left channel) and 18 (right channel) pins.

The signal that converted to analog is amplified at POWER AMP (IC201:TA2131), outputted to HEADPHONE terminal.

 - The exchange of signals between the DRAM and the MD LSI is performed using four data lines (pin 1, 2, 24 and 25 of the DRAM and pin 43, 44, 45 and 46 of the MD LSI).

Record

- Analog signal that is inputted from MIC IN or LINE IN, is amplified at LINE/MIC AMP, inputs to 6 (left channel) and 3 (right channel) pins of AD/DA converter (IC601).
- The analog signals input to the A/D-D/A converter (IC601) are converted to digital signals with a sampling frequency of $f_s=44.1\text{kHz}$ and then output from pin 12 to pin 65 of the MD LSI (IC3).
- The signals input from OPTICAL IN are input to pin 70 of the MD LSI (IC3).
- The signals input to pin 70 of the MD LSI (IC101) are converted to a sampling frequency of $f_s=44.1\text{kHz}$ by an fs converter inside the LSI. If the signals are already $f_s=44.1\text{kHz}$, they bypass the fs converter.
- The signals converted to $f_s=44.1\text{kHz}$ or the signals input to pin 65 are ATRAC-encoded and stored in the 16M DRAM (IC102).
- The signals are sequentially taken from the 16M DRAM (IC102) and sent back to the MD LSI (IC101), where they are ACIRC-processed and EFM-modulated and then output from pin 73 and pin 73 to the magnetic head.
- The magnetic disc records the signals onto the disc by magnetizing the magnetic film on the surface of the disc. During recording the laser diode emits its laser beam in order to raise the temperature to the Curie temperature (*4) that is required to magnetize the magnetic film. For this reason, the optical power of the laser diode is higher during recording than during playback.

In the case of this unit SJ-MR100, it is performed to write to the disc with double velocity (disc rotation is also double velocity). TOC writing is continuous movement (recording signal to magnetic head is sent with continuously).

Control

- Performs the necessary controls for each operation during playback and recording and for writing of the UTOC (*5) at the end of recording.
 - The information written in the UTOC includes the recorded track numbers and their addresses, text data, etc.
- Performs the necessary displays of the text data recorded on the disc and for each operation.

The system is designed for integrated operation, so that the system control IC (IC101) on the MD servo PCB.

Clock

- The controls of the playback signal, recording signals, 4-channel driver IC, and of the RF IC (IC1) all function using the clock on the MD LSI as the master clock.
- A/D-D/A converter (IC601) is using FS384 signal of MD LSI as clock.

***1 Kerr effect**

A phenomenon in which the polarization plane of laser light reflected from a material shifts in one of two directions depending upon its "plus" or "minus" magnetic polarization.

***2 ACIRC Add on interleave CIRC**

The aim of Add-on interleave is to improve the resistivity in CD-ROM decoder from the burst error on the disc.

***3 ATRAC Adaptive Transform Acoustic Cording**

The digital data compressing system developed for MiniDisc in which audio signals can be reproduced with only about 1/5th in the data normally required for high fidelity reproduction.

***4 Curie temperature**

The temperature at which magnetism of a specific material dissipates. This temperature varies according to the material.

***5 UTOC..... User Table Of Contents**

Found only on recordable MiniDiscs, this area contains subdata (track number, etc.) which can be rewritten by the user.

6.2. Block Diagram

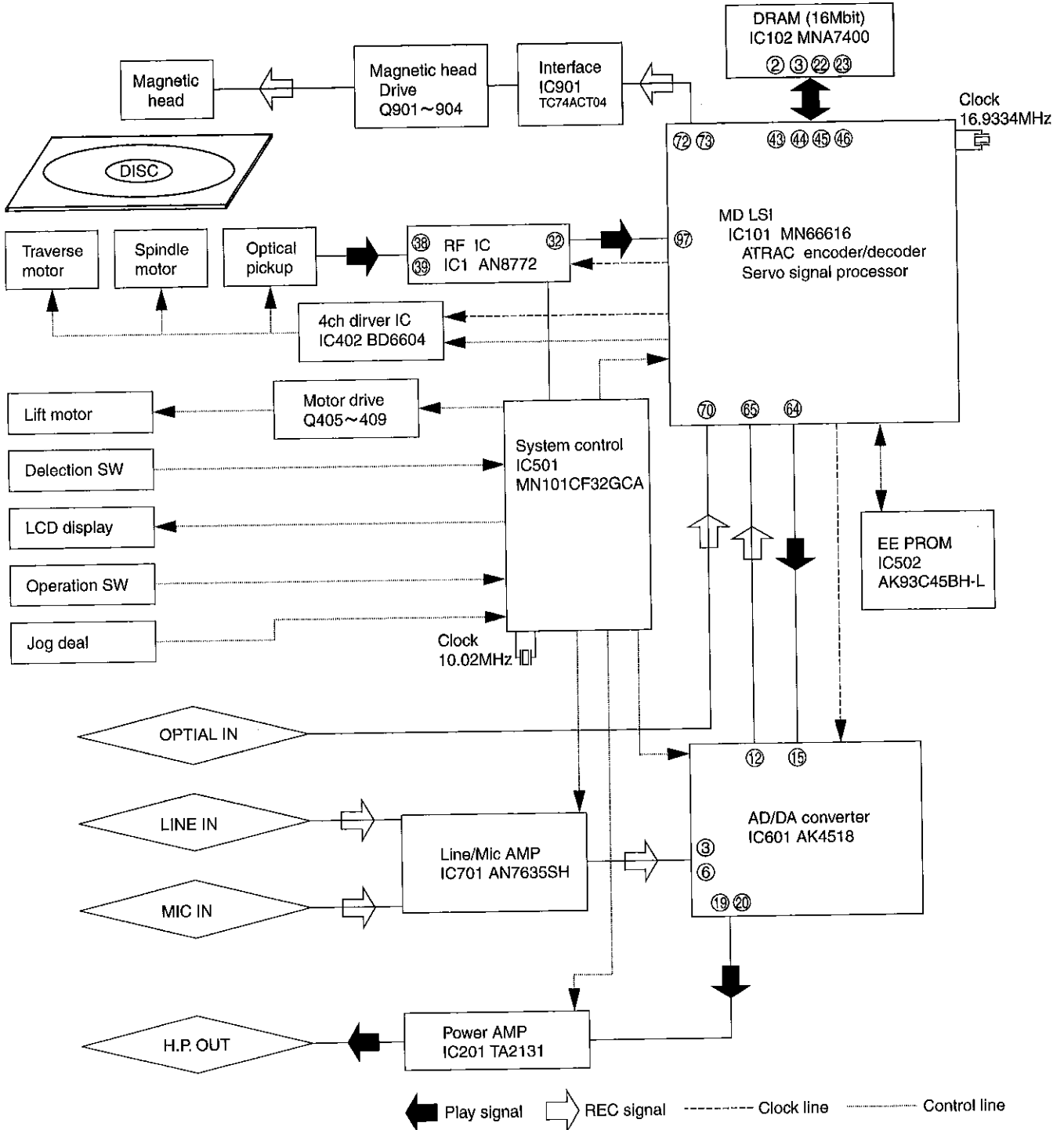

7 Measurements and Adjustments

Note:

If you exchange mechanism unit "RAE1620Z" when you repair, you must perform the automatic adjustment and checking of "playback-only disc" "magneto-optical disc" at the "adjustment mode".

■ Instruments to prepare

1. Test disc (Playback-only disc)
2. Commercially available recordable disc (fully recorded with music) (magneto-optical disc)
3. Laser power meter (Advantest TQ8210 or compatible meter)
4. Insulated driver for adjustment such as a ceramic driver
5. Remote controller

■ Laser power adjustment, Playback-only disc/magneto-optical disc automatic adjustment

• How to enter adjustment mode

1. Check the PC board. (Refer to the item of "Checking for the P.C.B." in "Operation Checks and Main Component Replacement Procedures").
2. Set the battery and connect the remote controller.
3. Make the optical pickup move to the center of the moving range.

*How to make it move.

- a. Play the track No.4 or 5 of Playback-only disc.
- b. Remove the battery on the playing (switch off the power).
- c. Remove the disc. Confirm that the optical pickup's position is about in the center, and close the disc cover.
- d. Switch on the power.

Note)

If the optical pickup does not move to the center by this method, you don't have to adjust. You must repair with referring to "Troubleshooting Guide".

4. Turn off the power, and switch main unit's HOLD switch off.
5. Turn off the power. Then, with the main unit's HOLD switch at OFF, press the VOL+, VOL-, ►►, and ◀◀ buttons on the remote controller within two seconds without pressing the OFF button.

- a. Using your thumb, while pressing the VOL+ button, also press the VOL- button.
- b. Then, while still pressing the VOL- button, release your thumb from the VOL+ and press the ►► button.
- c. While still pressing the ►► button, release your thumb from the VOL- button and press the ◀◀ button. Then, while still pressing the ◀◀ button, release your thumb from the ►► button and then from the ◀◀ button. (a-c are shown in Fig.3)

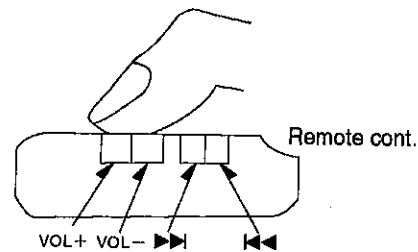

Using your thumb, while pressing the VOL+ button, also press the VOL- button.

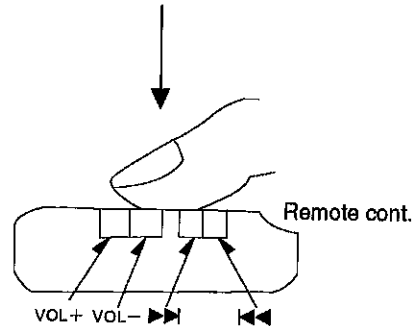

Then, while still pressing the VOL- button, release your thumb from the VOL+ and press the ►► button.

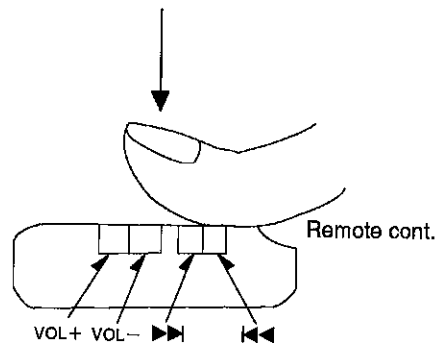

While still pressing the ►► button, release your thumb from the VOL- button and press the ◀◀ button. Then, while still pressing the ◀◀ button, release your thumb from the ►► button and then from the ◀◀ button.

Fig.3

6. When the adjustment mode is activated, "TA" will be displayed on the LCD of remote controller. After "TA" is displayed, select the desired adjustment item with the ►► button or ◀◀ button of the remote controller.

Adjustment mode	Display
Playback-only disc automatic adjustment	T1
Magneto-optical disc automatic adjustment	T2
Playback-only disc automatic adjustment value check	T3
Magneto-optical disc automatic adjustment value check	T4
Laser power check	T5
ADIP/EFM jitter measurement (double velocity)	T6
ADIP error rate measurement (double velocity)	T7
Error rate measurement (double velocity)	T8
Tilt measurement (disc middle speed)	T9
PWB inspection (audio test)	TA
PLAY/REC erase mode	TB
No blank disk play mode	TC
Asing mode	TD
(Spare)	TE

*In the display of T1 ~ TA shown above, you must adjust T1, T2 and T5. You must perform the adjustment by observing the order T5→T2→T1.

7.1. Laser Power Adjustment

Adjust each laser power: read power for reading (play) and write power for writing (record).

7.1.1. Set the Unit to the Adjustment Mode

Cautions

1. About handling the MD unit

- The magnetic head is a precision unit and is very fragile. Do not deform it.
- Laser diode in the optical pickup may be destroyed by the static electricity generated in your clothes or body. Be especially careful with the static electricity.
- The optical pickup is structured extremely precisely. Do not subject to the strong impact or shock. Do not touch the lens.

2. About the driver for adjusting laser power

Use only insulated driver such as a ceramic driver. With the metal driver, it is not possible to adjust properly because of the induction noise. Also, if it short-circuits with the chassis, it may destroy or damage the laser diode.

Recommended driver: VESSEL 9000 1.8 -30 (Ceramic driver)

3. Cautions on optical pickup:

- The optical pickup and the magnetic head are structured precisely; therefore, they are very fragile. Be careful not to touch them with the edge of the laser power meter.
- The sensor of the laser power meter is a very fine part. Be careful not to touch it to the optical pickup lens.
- Do not loosen or remove the magnetic head installing screw.
- The focus point of the laser reaches to 356°F. Therefore, avoid adjusting using laser power for a long time because the sensor of the laser power meter may be burned.
- Do not allow the write power to even momentarily

reach or exceed 5 mW. Doing so will result in damage to the optical pickup.

- Do not set the unit to the laser power adjustment mode with the MD loaded. Doing so may result in damage to the MD.

7.1.2. Adjustment Procedure

1. Show "T5" on the LCD by pressing the **▶▶** or **◀◀** button of the remote controller.
2. Make the sensor cover of the laser power meter slide. (refer to Fig.4)

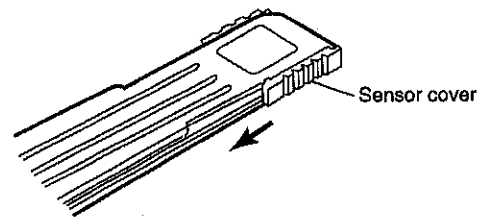
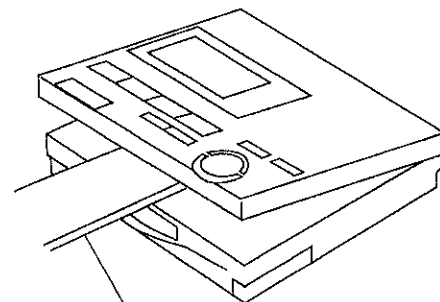

Fig.4

3. Set the laser power meter. (refer to Fig.5)



Laser power meter

Fig.5

4. Press the PLAY key of the remote controller ("T5" changes to "LP" of the LCD).
5. Perform the read power adjustment. Turn VR1 and set to $600\mu\text{W}\pm 10\%$. (refer to Fig.6)

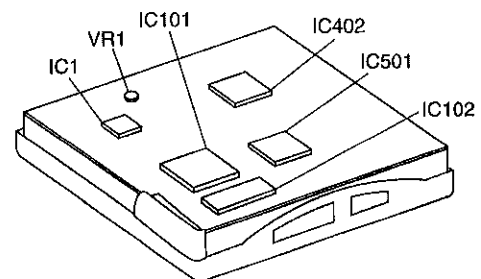

Fig.6

6. Press the **▶▶** key of the remote controller ("LP" changes to "BLDA" in the LCD).

Specified range (read power): $600\mu\text{W}\pm 10\%$ or lower

Caution:

- Proceeding on to the subsequent adjustment procedure with the read power exceeding $600\mu\text{W}\pm 10\%$ will result in damage to the optical pickup.

7. Perform the light power adjustment. Set the light power at 4.5mW by using VOL+ and VOL- key of the remote controller. Then, if the voltage between TP405 and TP406 divided by 1Ω is more than power supply indication of

optical pickup FPCx1.2, it is optical pickup breakdown.

- Press the **▶▶▶** key of the remote controller ("BLDA" changes to "LP" on the LDC. At this time, the data is written to EEPROM.).

Specified range (light power): 4.5mW

Caution:

- Do not allow the write power to even momentarily reach or exceed 5 mW. Doing so will result in damage to the optical pickup.

- Press the PLAY key on the remote controller ("LP" changes to "T5" on the LCD.).
- Remove the laser power meter. Laser power adjustment is finished.

• Magneto-optical disc automatically adjustment

- Show "T2" on the LCD by pressing the **▶▶▶** or **◀◀◀** button of the remote controller.
- Set the full-recorded magneto-optical disc with the prevention erase situation.
- Press the PLAY key of the remote controller ("T2" changes to "OAAJ" on the LCD, adjustment is started.).
- If it has been finished normally, "OAAJ" changes to "OAK" on LCD. If it is abnormally, it changes to "OANG".
- Press the PLAY key ("OAK" or "OANG" changes to "T2", magneto-optical disc adjustment is finished.).

Note)

If it is displayed "OANG", check the "Troubleshooting Procedures" in the order.

• Playback-only disc automatically adjustment

- Show "T1" on the LCD by pressing the **▶▶▶** or **◀◀◀** button of the remote controller.
- Set the playback-only disc.
- Press the PLAY key of the remote controller ("T1" changes to "OAAJ" on the LCD, adjustment is started.).
- If it has been finished normally, "OAAJ" changes to "OOK" on LCD. If it is abnormally, it changes to "OONG".
- Press the PLAY key ("OAK" or "OANG" changes to "T1", playback-only disc adjustment is finished).

Note)

If it is displayed "OONG", check the "Troubleshooting Procedures" in the order.

After the 1.2.3. adjustment written above, remove the battery when you finish the adjustment mode.

■Checking the main unit's keys

- Check the PC board. (Refer to the item of "Check for the P.C.B." in "Operation Checks and Main Component Replacement Procedures").
- Set the battery and connect the remote controller.
- Turn off the power. Then, with the main unit's HOLD switch at OFF, press the VOL+, VOL-, **▶▶▶**, and **◀◀◀** buttons on the remote controller within two seconds without pressing the OFF button.

a. Using your thumb, while pressing the VOL+ button, also

press the VOL- button.

- Then, while still pressing the VOL- button, release your thumb from the VOL+ and press the **▶▶▶** button.
- While still pressing the **▶▶▶** button, release your thumb from the VOL- button and press the **◀◀◀** button. Then, while still pressing the **◀◀◀** button, release your thumb from the **▶▶▶** button and then from the **◀◀◀** button. (a-c are shown in Fig.7)

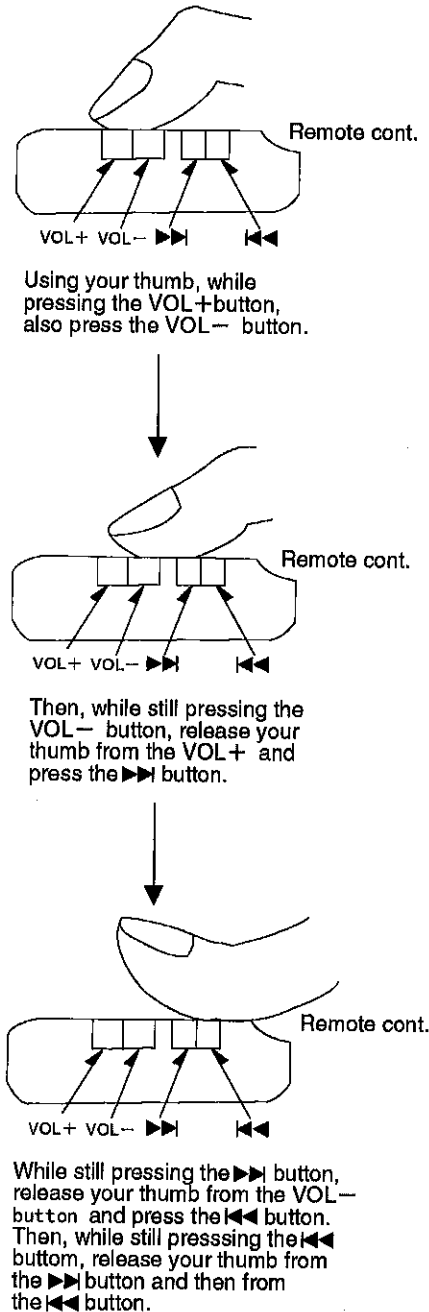

Fig.7

- When entering the main unit's key check mode, "KEYJP" will be displayed on the LCD of main unit and remote controller.
If it is not displayed, perform the procedures written above again.
- Confirm the display of LCD by pressing any keys on the main unit. There is no order to press the keys.

Main unit's keys	LCD display positions and letters
HOLD OFF	1st. letter is A
ENTER	2nd. letter is B
SPACE	3rd. letter is C
POWER OFF	4th. letter is D
VOL+	5th. letter is E
VOL-	6th. letter is F
DELETE	7th. letter is G
EDIT	8th. letter is H
DISPLAY	9th. letter is I
CHARA	10th. letter is J
PAUSE	11th. letter is K
JOG rotation	12th. letter is L

6. Remote controller's LCD lights "KEY OK" and main unit's LCD lights all when you can detect all keys.

7. Perform below voltage check about the keys come under if you cannot detect the key.

Main unit's keys	Measurement points	ON	OFF
HOLD	TP428	0V	2.6V
ENTER	TP420	2.0V	2.6V
SPACE	TP420	1.3V	2.6V
POWER OFF	TP420	0.6V	2.6V
VOL+	TP420	0V	2.6V
VOL-	TP419	2.0V	2.6V
DELETE	TP419	1.3V	2.6V
EDIT	TP419	0.6V	2.6V
DISPLAY	TP419	0V	2.6V
CHARA	IC501 48pin	0V	2.5V
PAUSE	IC501 49pin	0V	2.5V
JOG rotation	IC501 59,60pin	0V	2.6V

Confirm the waveform for JOG rotation.

8. Remove the battery when you exit from this mode.

Note:

Refer to "Printed Circuit Board and Wiring Connection Diagram" for the test points.

7.2. Self-diagnosis Function

This model is equipped with a self-diagnosis function and shows, when necessary, the following indication in the LCD section of the set.

(LCD display)

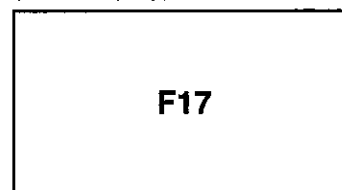

"F17"---This indication appears when the Down switch fails to turn ON since the magnetic head fails to move up/down normally (Due to trouble of the magnetic head or trouble of the magnetic head up/down motor) or the magnetic head P.C.B. is out of position or a foreign matter has mixed in or for some other reason.

In such a case, check the peripheral parts of the magnetic head, repair or replace defective parts with normal ones.

8 Troubleshooting Guide

Note) We mentioned "※Filter" beside the waveform about the points for necessary the filter when you check the waveforms.
 Check it with setting the band width of the meter about 5~10kHz, or connecting the filter shown below.

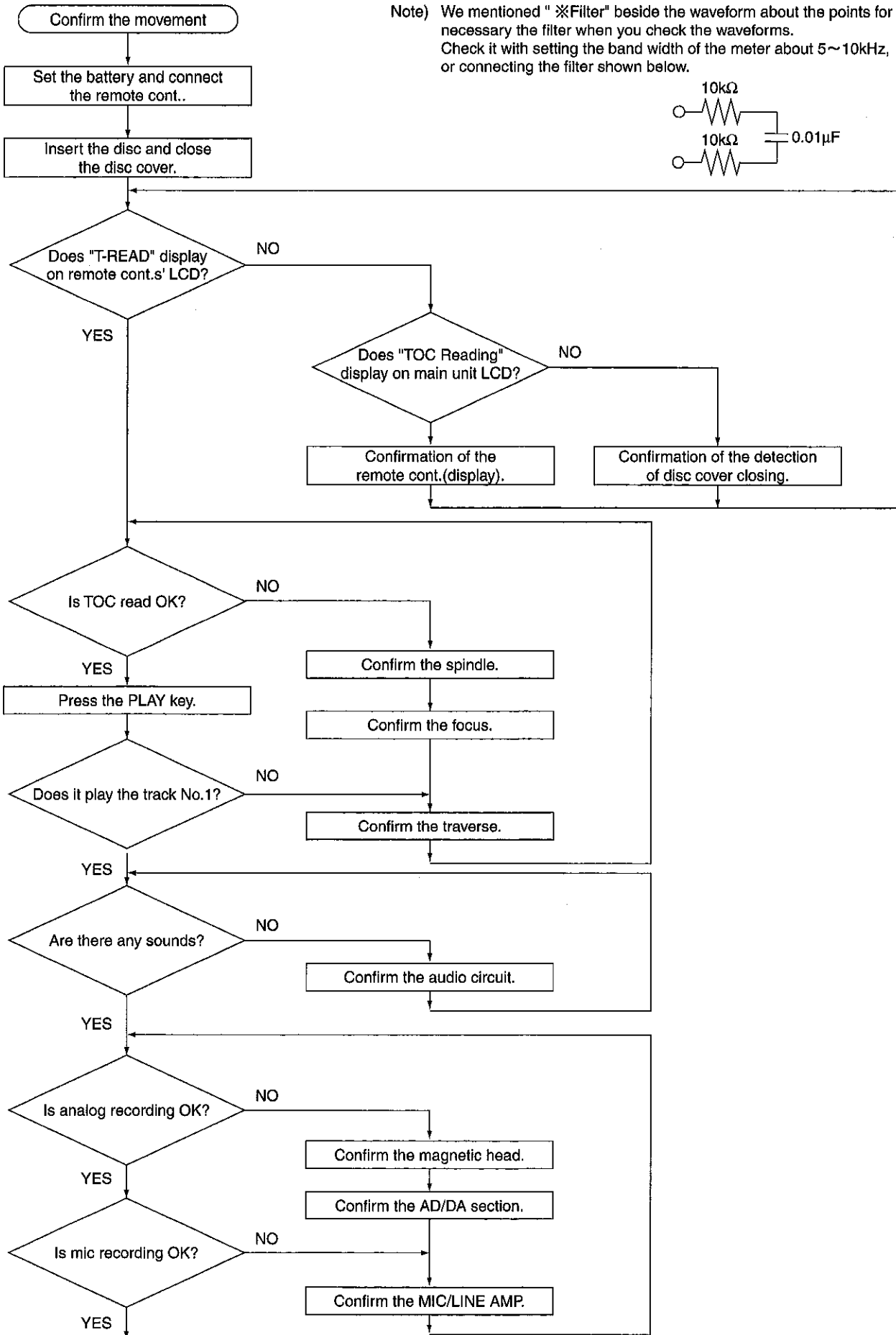
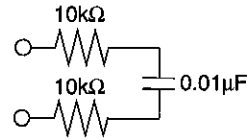

Continuing to next page.

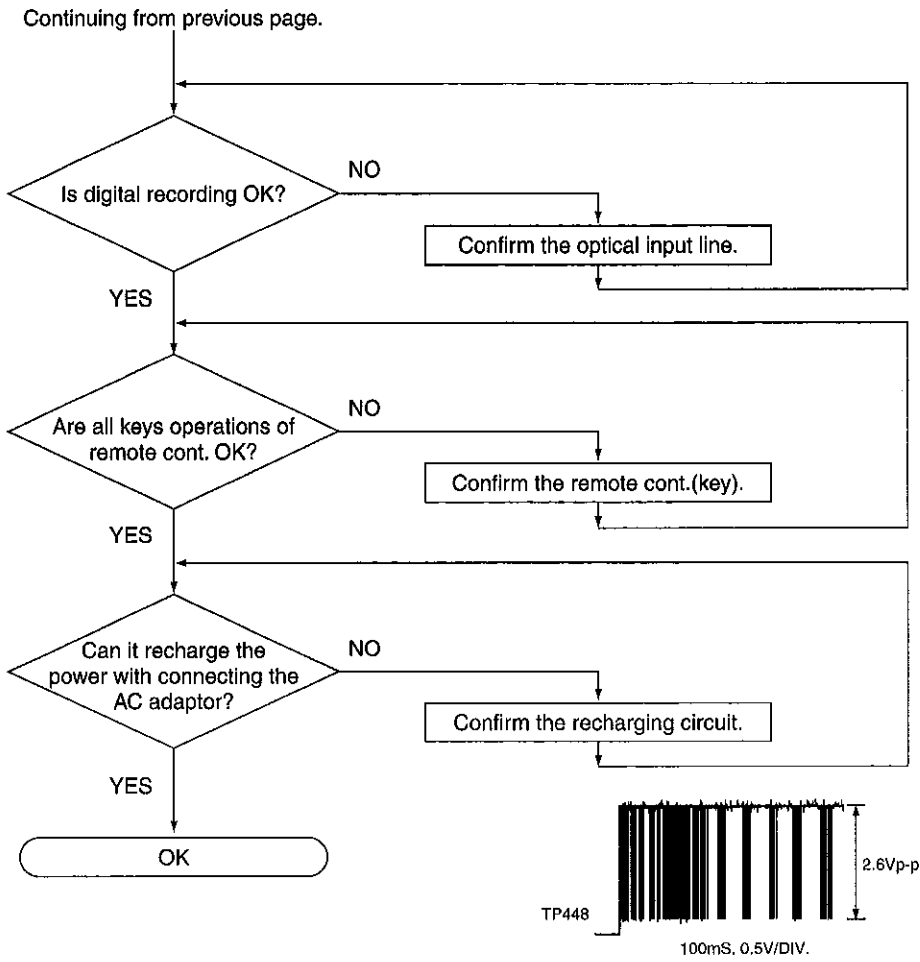

Confirmation of the remote cont.(display)

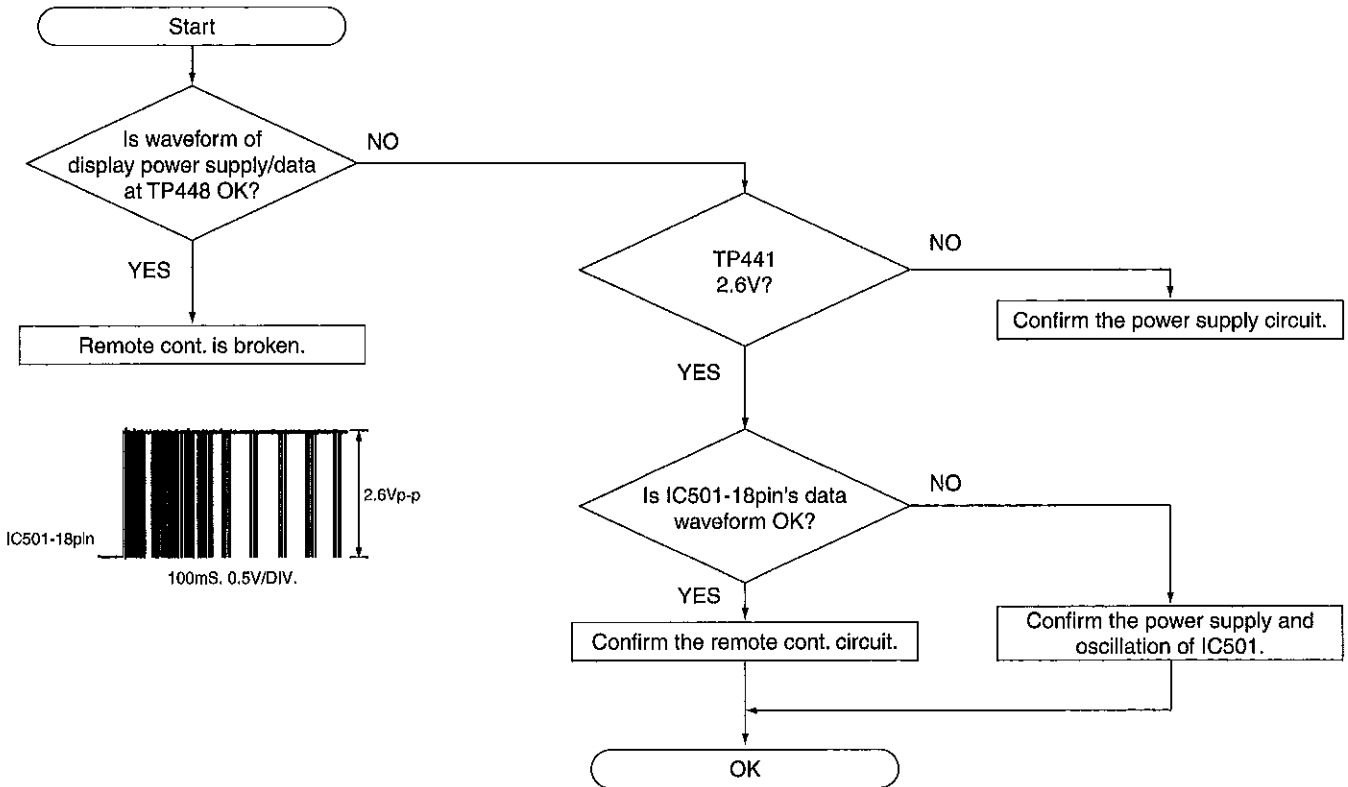

Confirmation of the detection of the disc cover closing.

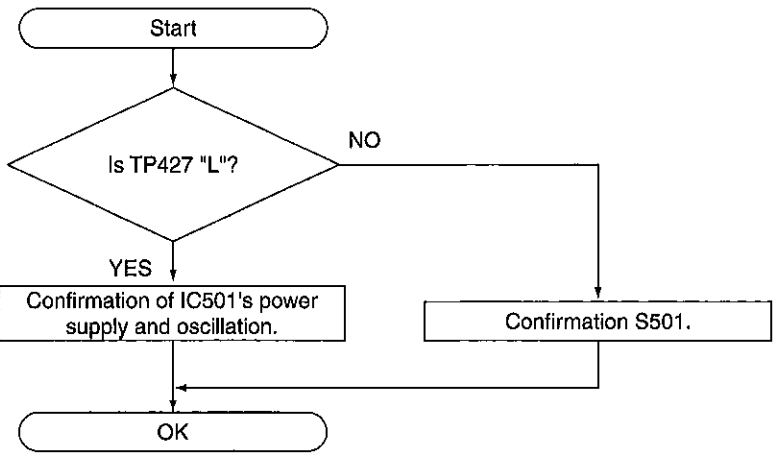

Confirmation of spindle.

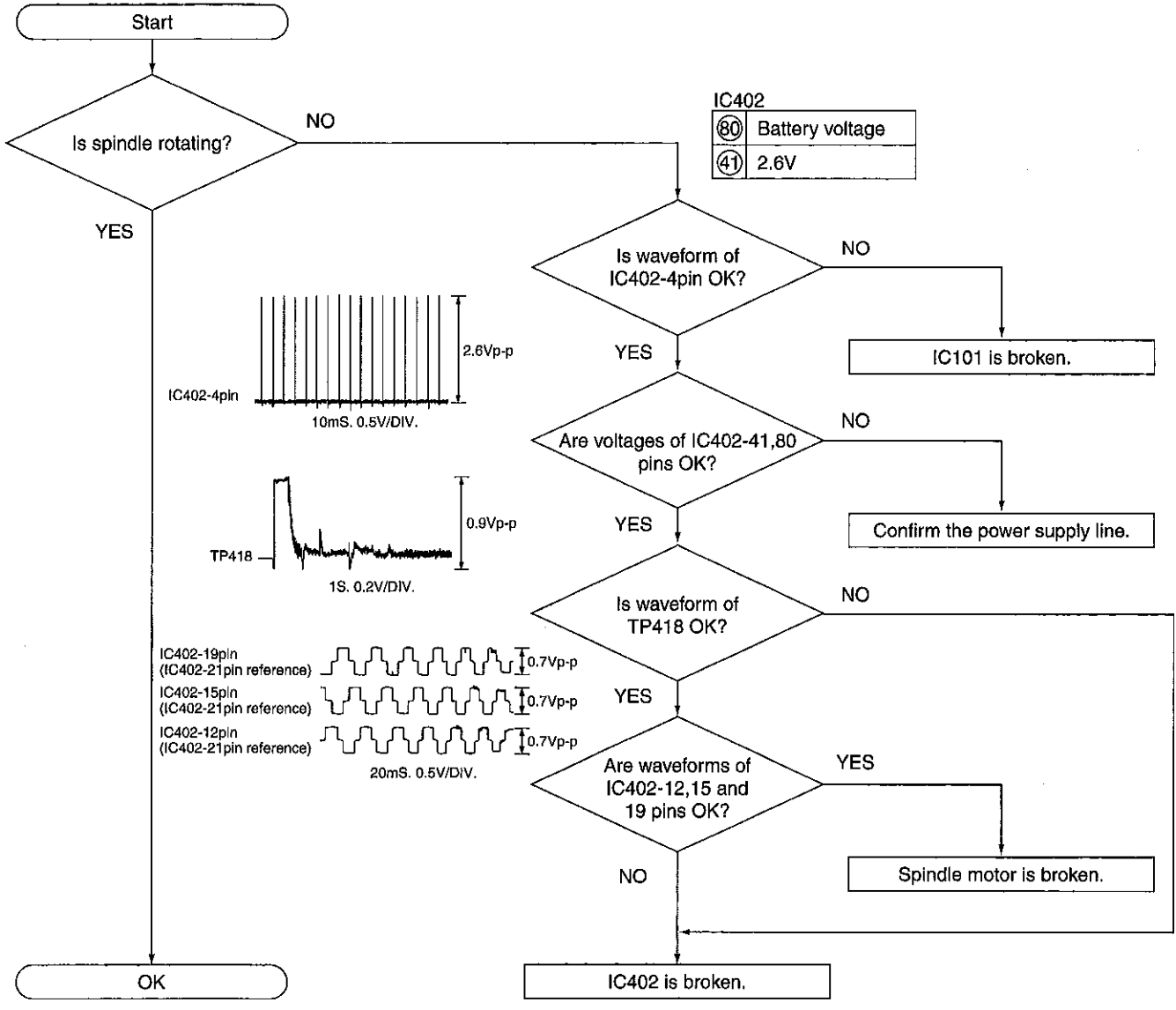

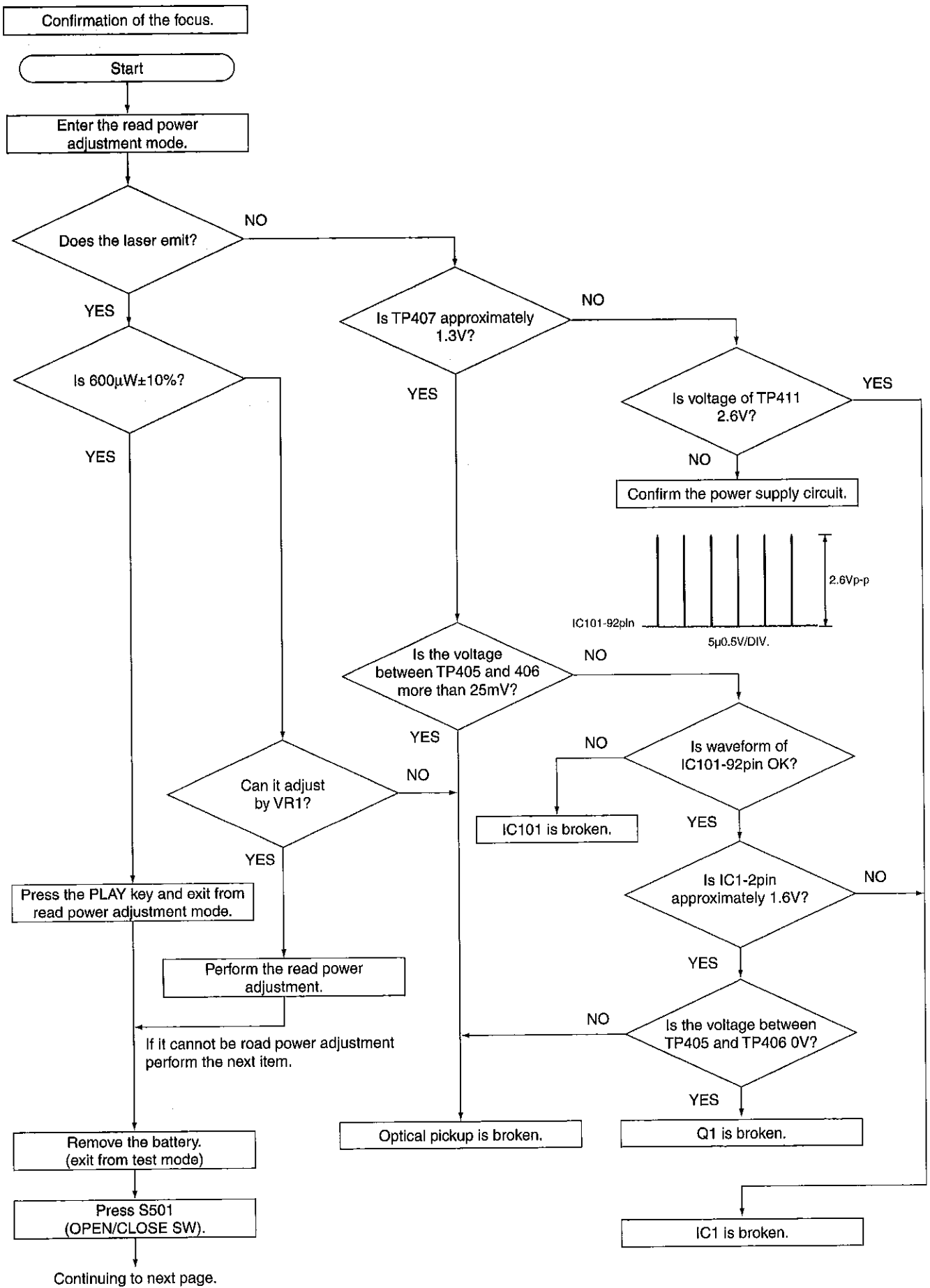

Continuing from previous page.

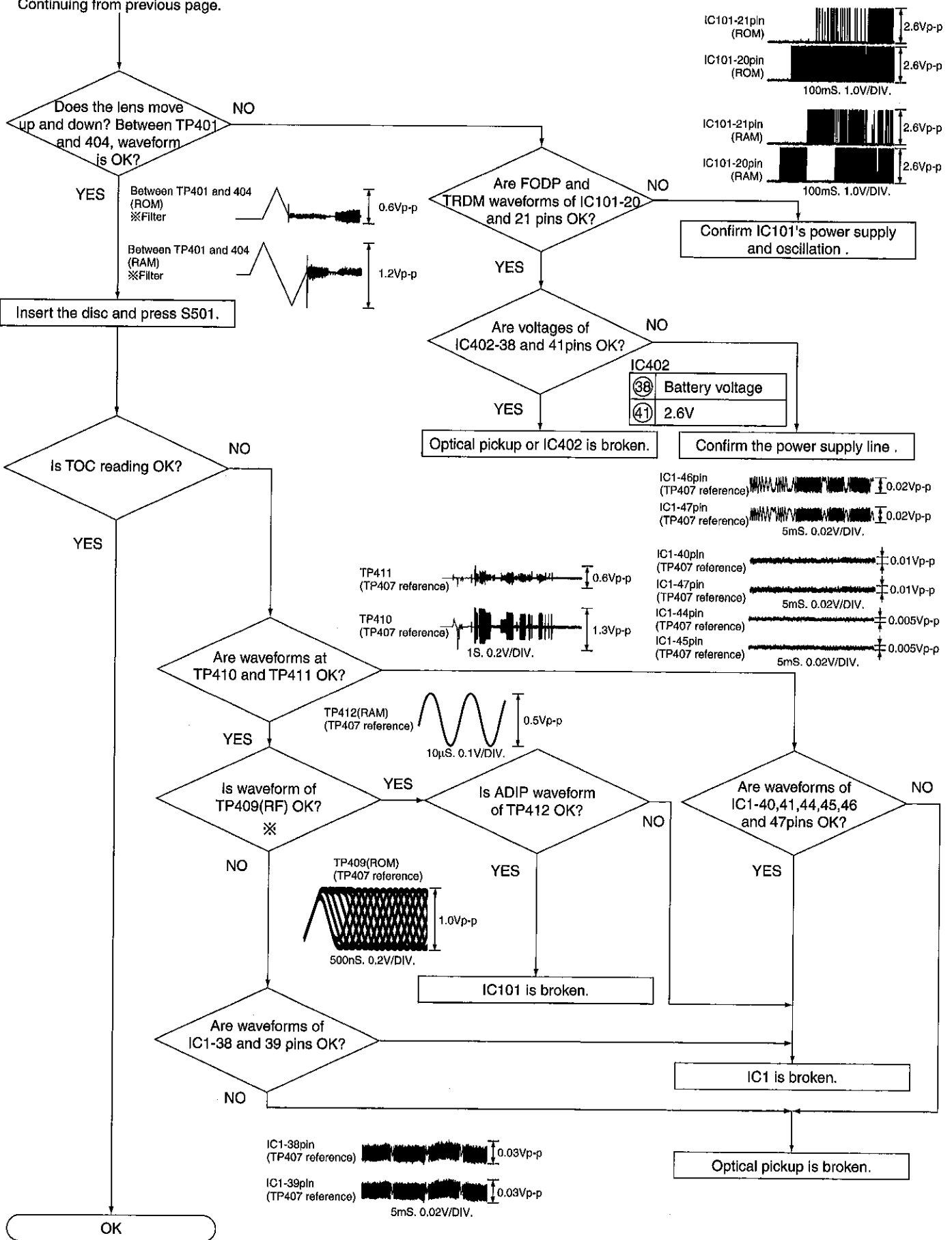

※) When you confirm RF waveform, perform "EFM jitter measurement" in "Adjustment mode" (refer to "7.Measurements and Adjustments"). And you'll be able to observe the continuous waveforms.

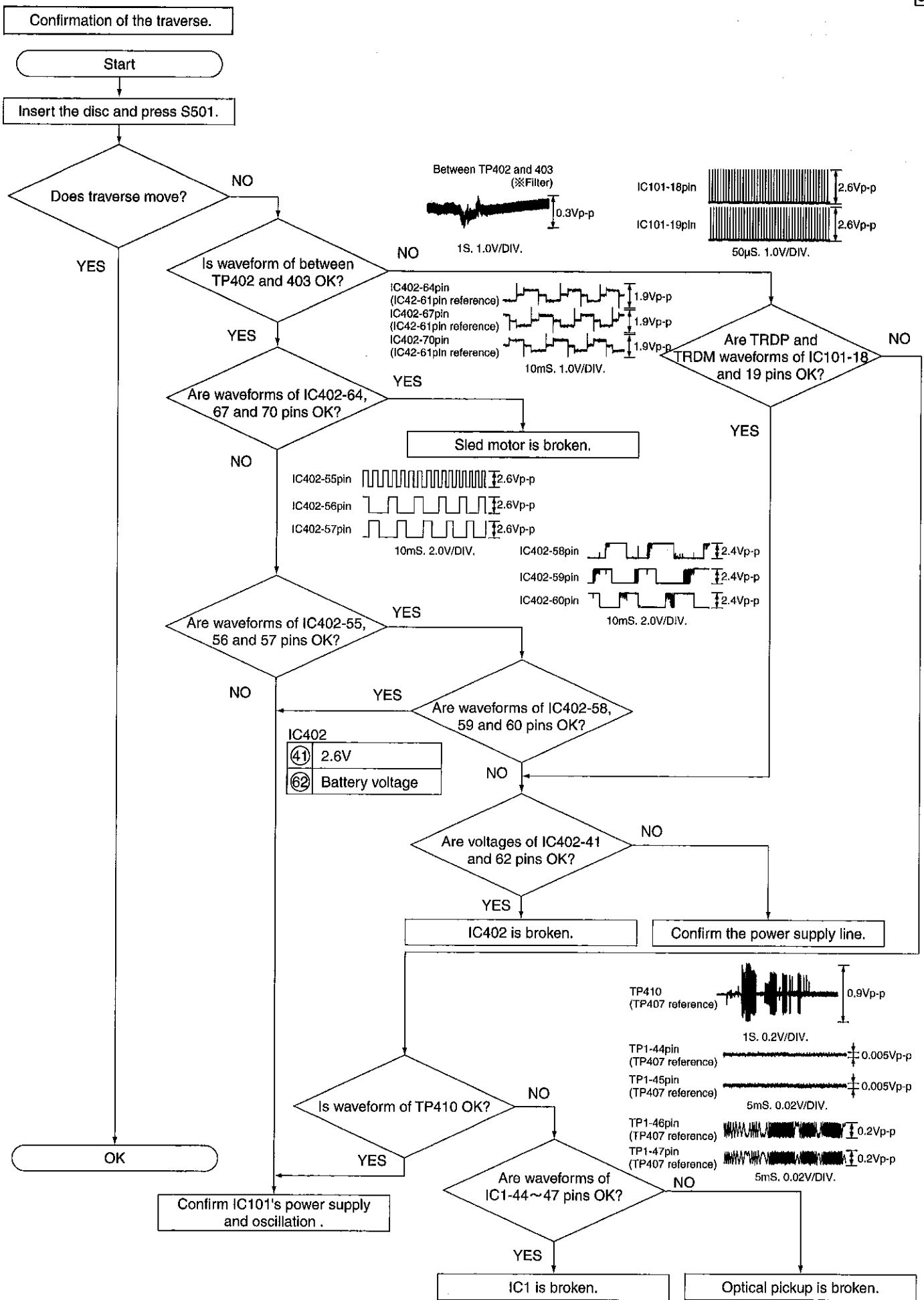

Confirmation of audio circuit.

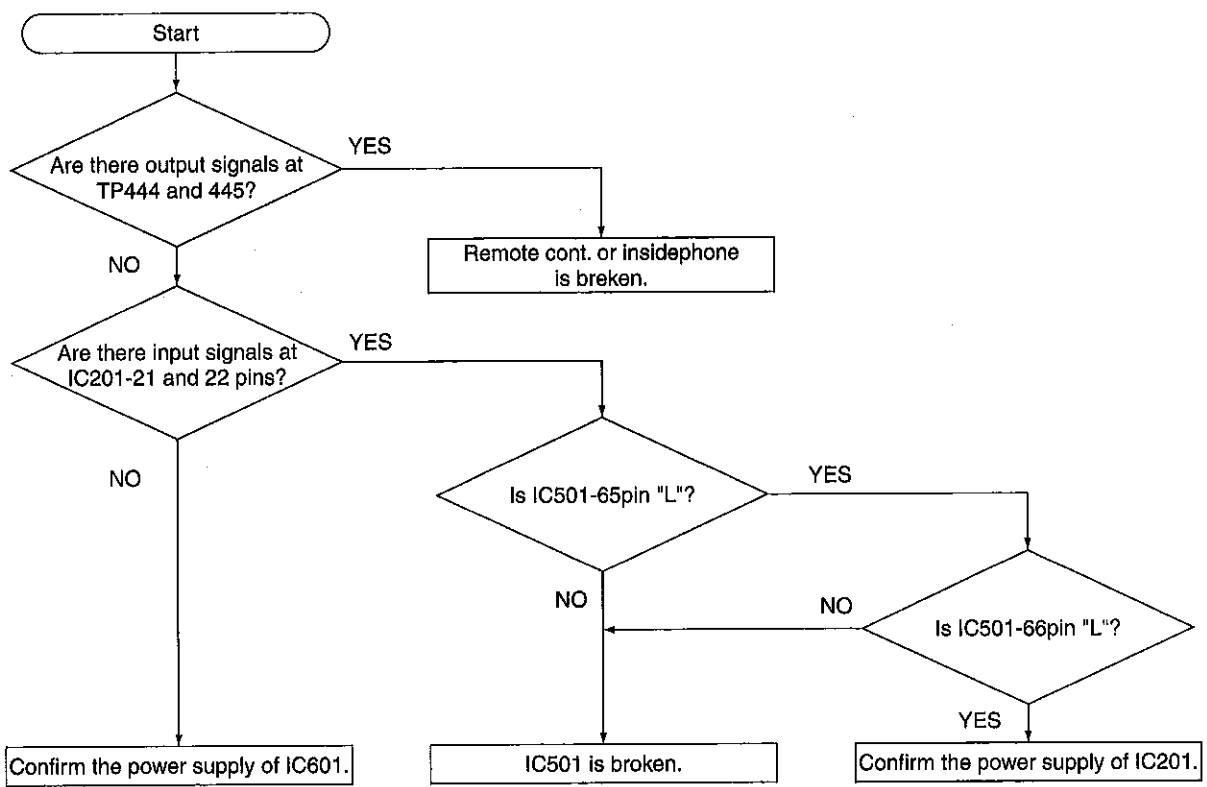

Confirmation of the magnetic head.

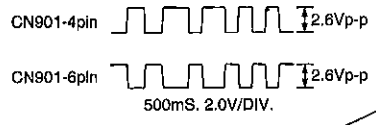
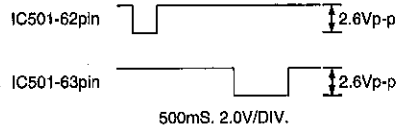
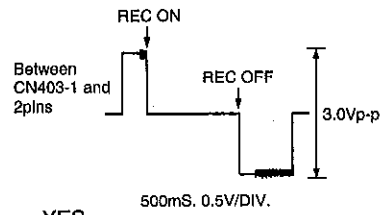
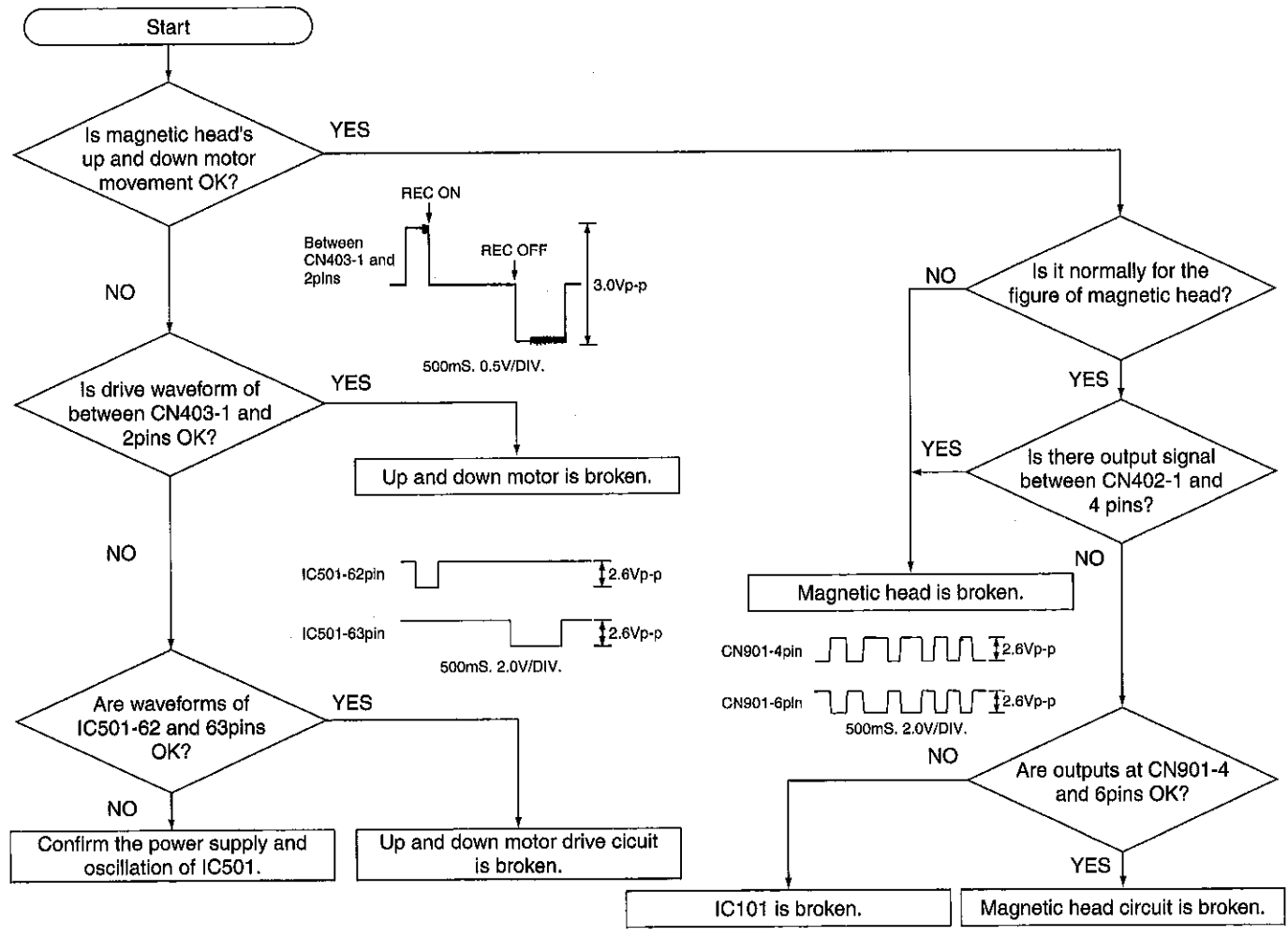

Confirmation of AD/DA section.

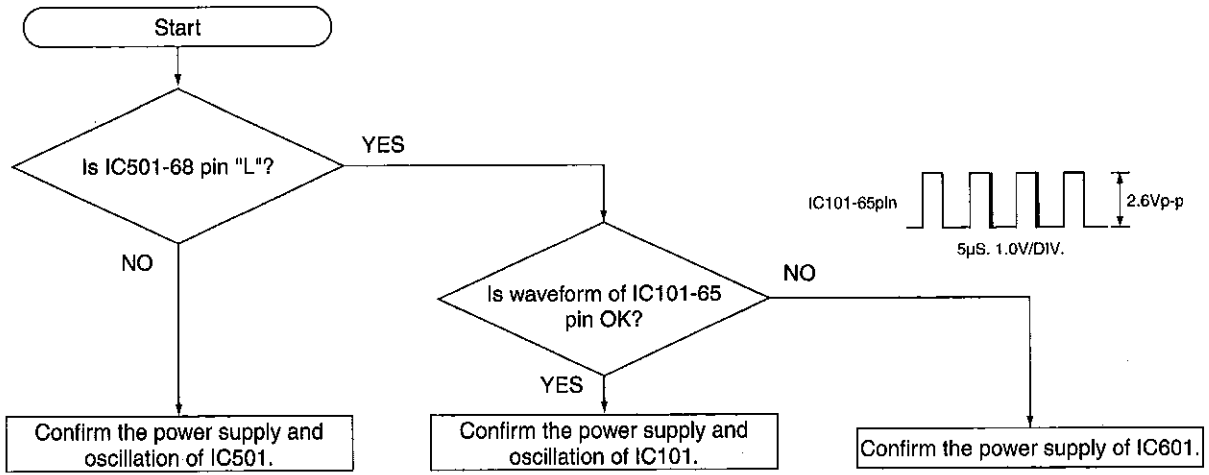

Confirm the MIC/LINE AMP section.

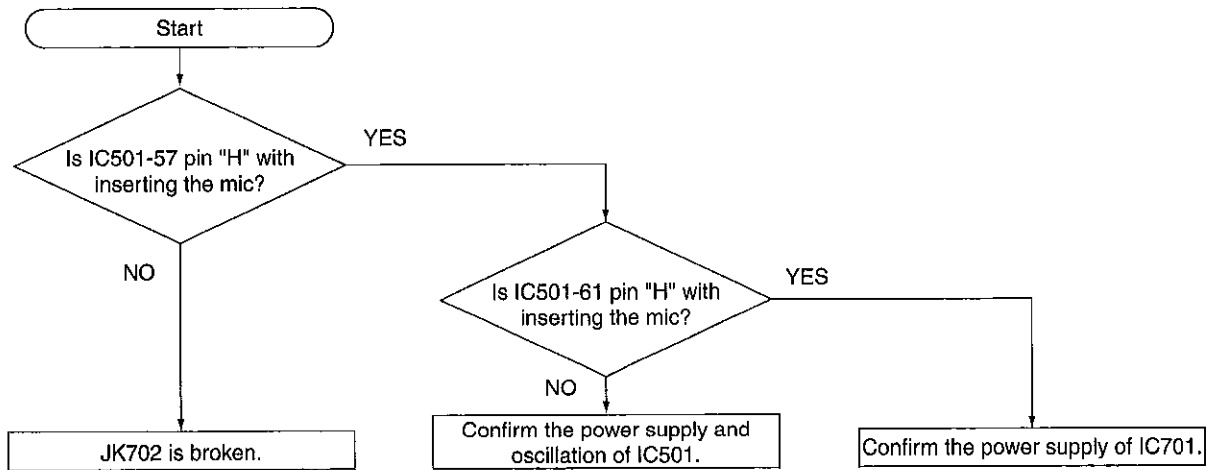

Confirmation of the optical input.

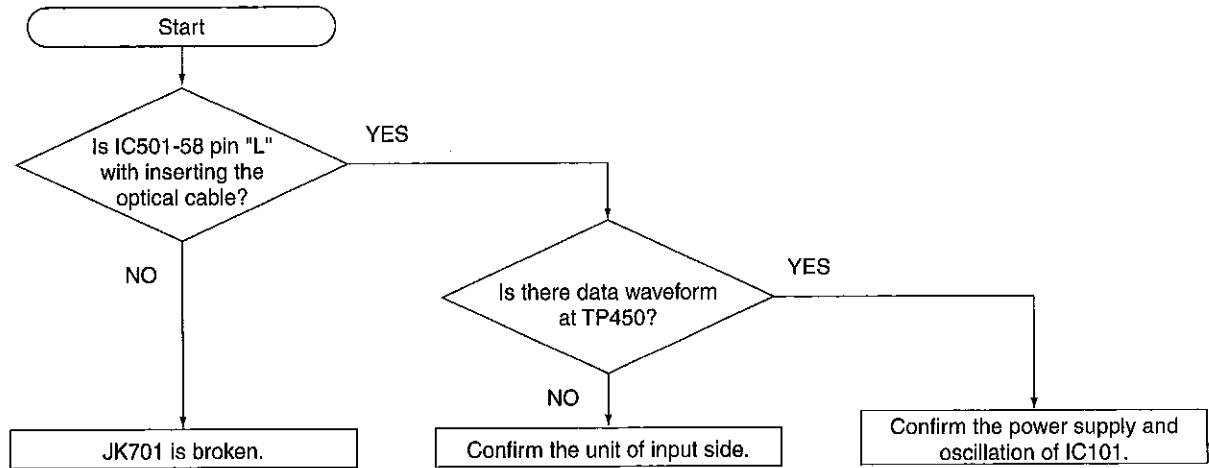

Confirmation of the recharging circuit.

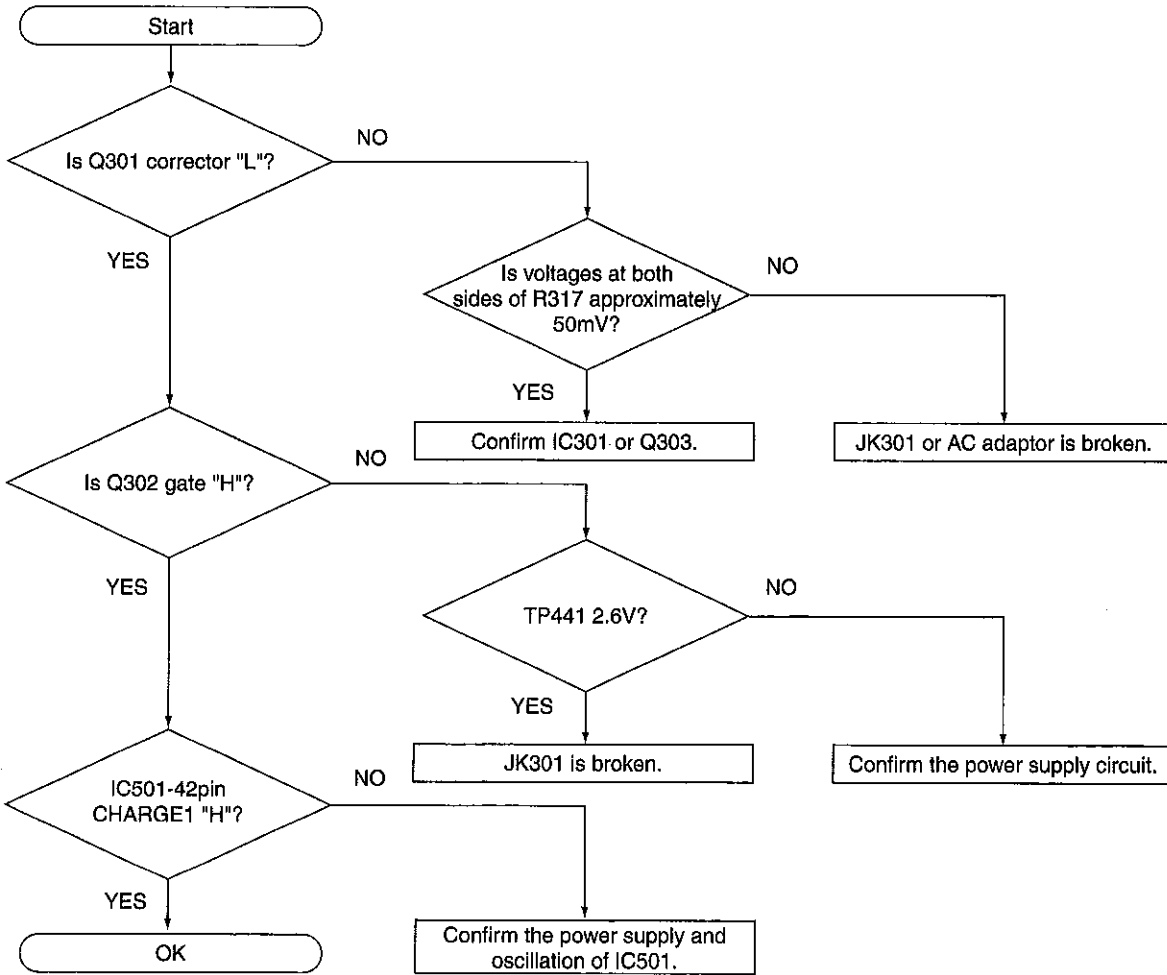

Confirmation of remote cont. (key)

o Confirm the waveform at TP449 and the voltage when the keys are pressed.

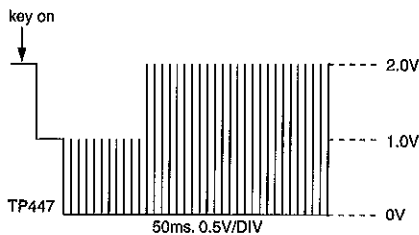

MAIN	SUB	HOLD	VOLTAGE	BOUNDARY VOLTAGE	MAIN	SUB	HOLD	VOLTAGE	BOUNDARY VOLTAGE
PLAY			0.1						
				0.2948		DISPLAY		1.69	1.5783
VOL+			0.442	0.6405				1.90	1.8096
VOL-			0.841	0.9048				2.19	2.0434
	EQ MODE		1.11	1.1666				2.41	2.3052
	PLAY MODE		1.31	1.4182			HOLD	2.6	2.5085
			1.5		(WITHOUT REMOTE CONT.)				

9 Checking Procedures of Main Components Parts on the Main P.C.B. (B side)

As it cannot measure the mechanism side of MAIN P.C.B. directly, refer to the table shown below for the criterion in the time of repairing or checking.

Circuit No.	Part No.	Function	Symptom	Check point	Result and measure
IC301	NJU7015RTE1	Op amp for control of recharging circuit	Impossible to recharge.	Perform "Confirmation of the recharging circuit" in "Troubleshooting Guide".	If it comes under in "Troubleshooting Guide", check the foil around IC301 or Q304. If there are no abnormal things, change the parts that is coming under.
IC302	XC6368A261MR	DC-DC converter	No power.	1. Confirm the voltage of TP411 (1.3V). 2. Confirm the gate waveform of Q306 (oscillating or not, oscillation frequency is approx. 100kHz)	Check the foil around IC302 when the voltage of TP441 is low (about 1.2V) and there is no gate waveform oscillation. If there are no abnormal things, change IC302.
IC303	XC6367A151MR	DC-DC converter	Impossible to play and record.	1. Confirm the voltage of TP442 (1.5V). 2. Confirm the voltage of TP441 (2.6V).	Check the foil around IC303 when the voltage of TP441 is normal but TP442 is low (about 1.2V). If there are no abnormal things, change IC302.
IC304	XC6372C501PR	DC-DC converter	Impossible to record.	1. Confirm the voltage of TP443 (5V) 2. Confirm that IC501-74pin is "L".	Check the foil around IC304 when the voltage of TP443 is low (about 1.2V) and IC501-7pin is "L". If there are no abnormal things, change IC304.
IC601	AK4518VF-E2	AD/DA converter	No sounds. Impossible to record by analog input.	1. Digital (optical) input confirmation : Send the signals to IC201 (power amp) -21,22pins, confirm that if the sounds are heard or not. 2. Perform "Confirmation of AD/DA section" in "Troubleshooting Guide". *The voltage confirmation of IC601 : Confirm the voltage of R605 (5.6ohm) that in the middle of IC601-1pin and Q305 drain.	Check the foil around IC601 if the confirmation items are OK. If there are no abnormal things, change IC601.
IC701	AN7635SH-E1	LINE/MIC AMP.	Impossible to record by analog input.	Confirm that it can record by digital (optical), if it is OK, perform "Confirmation of MIC/LINE AMP section" in "Troubleshooting Guide". *The voltage confirmation of IC701 : Confirm that the leading between IC701-13pin and Q704 drain.	Check the foil around IC701 if the confirmation items are OK. If there are no abnormal things, change IC701.

10 Schematic Diagram Notes

10.1. Schematic Diagram Notes

This schematic diagram may be modified at any time with the development of new technology.

Notes:

- S501 : COVER OPEN det. switch.
- S502 : Hold (HOLD) switch (in "OFF" position).
- S802 : Play / record / pause / power on / character type (▶ / || , CHARA) switch.
- S803 : Recording pause / power on (REC PAUSE→) switch.
- S804 : Display, capital / lower case (DISPLAY, CAPS LOCK) switch.
- S805 : Changing edit mode, changing track mark mode, completing edit (EDIT, MARK MODE) switch.
- S806 : Play and record mode / character delete (MODE, DELETE) switch.
- S807, 808 : Volume / cursor (← - , + →, VOL / CURSOR) switches.
- S809 : Stop / power off / edit cancel (■ , POWER OFF) switch.
- S810 : Tone / recording sensitivity / space (EQ / REC SENS, SPACE) switch.
- S901 : Magnetic head up (M.HEAD UP) switch.
- S1101 : PROTECT det. switch.
- VR1 : Laser power adj. V.R..
- Indicated voltage values are the standard values for the unit measured by the DC electronic circuit tester (high-impedance) with the chassis taken as standard. Therefore, there may exist some errors in the voltage values, depending on the internal impedance of the DC circuit tester.

No mark: MD STOP

() : MD play [1kHz, L+R, 0dB]

Important safety notice:

Components identified by \triangle mark have special characteristics important for safety.

Furthermore, special parts which have purpose of fire-retardant (resistors), high-quality sound (capacitors), low-noise (resistors), etc. are used. When replacing any of components, be sure to use only manufacture's specified parts shown in the parts list.

Caution!

IC and LSI are sensitive to static electricity.

Secondary trouble can be prevented by taking care during repair.





Cover the parts boxes made of plastics with aluminum foil.

Ground the soldering iron.

Put a conductive mat on the work table.

Do not touch the legs of IC or LSI with the fingers directly.

Voltage and signal line

-  : Positive voltage line
-  : Playback signal line
-  : Recording signal "digital" line
-  : Recording signal "analog" line
-  : Mic signal line

10.2. Type Illustration of IC's, Transistors and Diodes

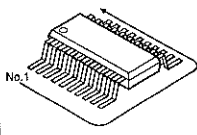
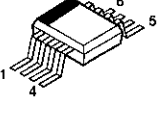
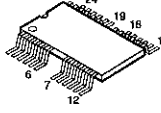
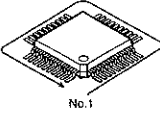
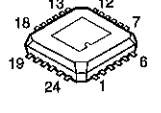
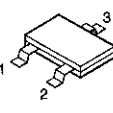
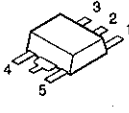
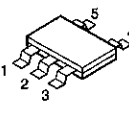
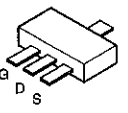
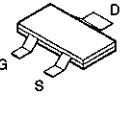
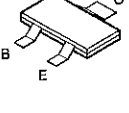
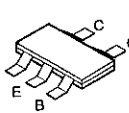
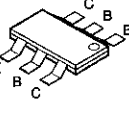
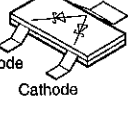
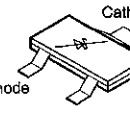
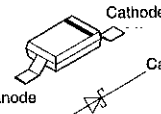
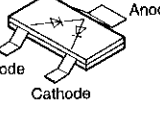
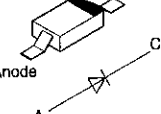
	<table border="1"> <tr><td>TC74ACT04FSE</td><td>14PIN</td></tr> <tr><td>AK4518VF-E2</td><td>24PIN</td></tr> <tr><td>AN7635SH-E1</td><td>24PIN</td></tr> <tr><td>NJU7015RTE1</td><td>8PIN</td></tr> </table>	TC74ACT04FSE	14PIN	AK4518VF-E2	24PIN	AN7635SH-E1	24PIN	NJU7015RTE1	8PIN	<p>AK93C45BH-L</p> 	<p>MNA7400CWA1T</p> 	<table border="1"> <tr><td>MN66616RB1</td><td>100PIN</td></tr> <tr><td>MN101CF32GCA</td><td>80PIN</td></tr> <tr><td>BD6604KVT</td><td>80PIN</td></tr> <tr><td>AN8772FHKEBV</td><td>48PIN</td></tr> </table> 		MN66616RB1	100PIN	MN101CF32GCA	80PIN	BD6604KVT	80PIN	AN8772FHKEBV	48PIN
TC74ACT04FSE	14PIN																				
AK4518VF-E2	24PIN																				
AN7635SH-E1	24PIN																				
NJU7015RTE1	8PIN																				
MN66616RB1	100PIN																				
MN101CF32GCA	80PIN																				
BD6604KVT	80PIN																				
AN8772FHKEBV	48PIN																				
<p>TA2131FL</p> 	<p>XC61FC2012MR</p> 	<p>XC6372C501PR</p> 	<p>XC6368A261MR XC6367A151MR</p> 	<p>2SK1764KYTR XP161A1355PR</p> 	<p>XP151A12A2MR XP152A12C0MR</p> 																
 <p>2SB1462STX 2SB1295-6-TB DTC144TETL 2SD2216STX DTC144EETL</p>	<p>UMG6NTR UMG2NTR</p> 	<p>XP4601TX</p> 	<p>MA741WATX</p> 	<p>RB491DT146 ZHCS1006TA</p> 																	
<p>F1J2ETP</p> 	<p>MA133TX</p> 	<p>MA2S111TX</p> 																			

11 Schematic Diagram

NOTE:
 Each parts on main p.c.b.(Side B) can not be checked directly, however, for the checking of main component parts on p.c.b., refer to the "Checking procedures of main component parts on the main p.c.b.(Side B)".

: POSITIVE VOLTAGE LINE
 : PLAYBACK SIGNAL LINE
 : RECORDING SIGNAL "DIGITAL" LINE

A MAIN CIRCUIT

△ MD OPTICAL PICKUP

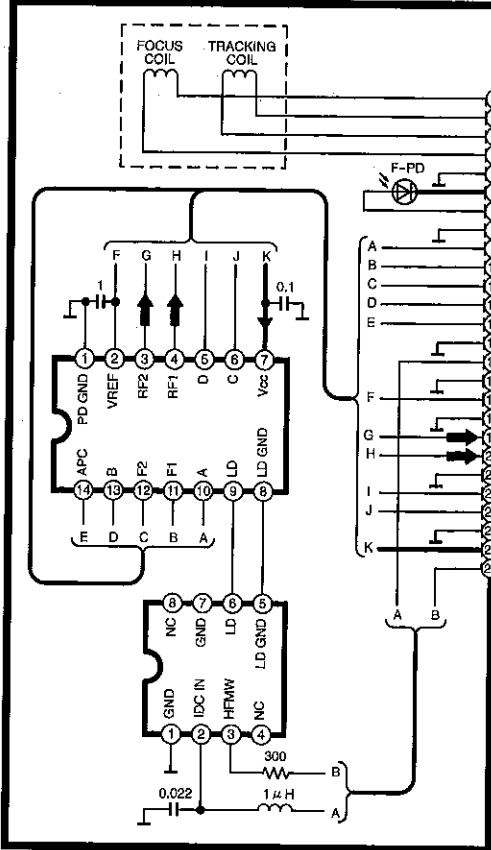

B SWITCH CIRCUIT

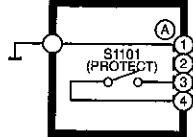

C REC HEAD CIRCUIT

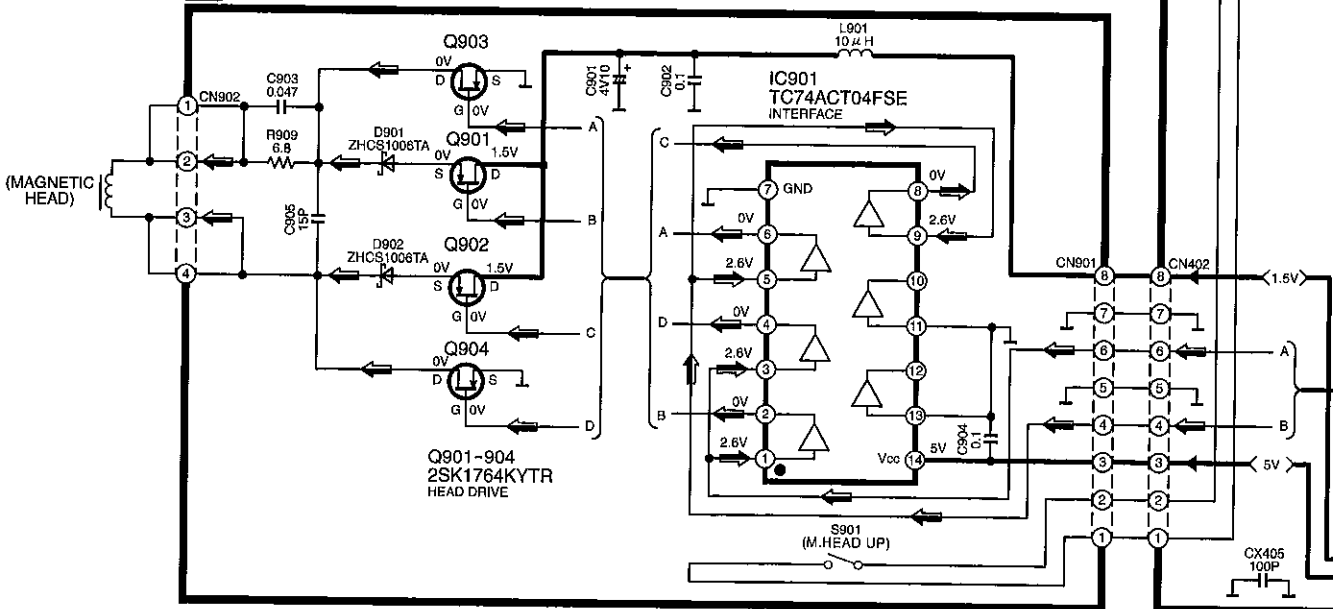

→ : POSITIVE VOLTAGE LINE → : PLAYBACK SIGNAL LINE

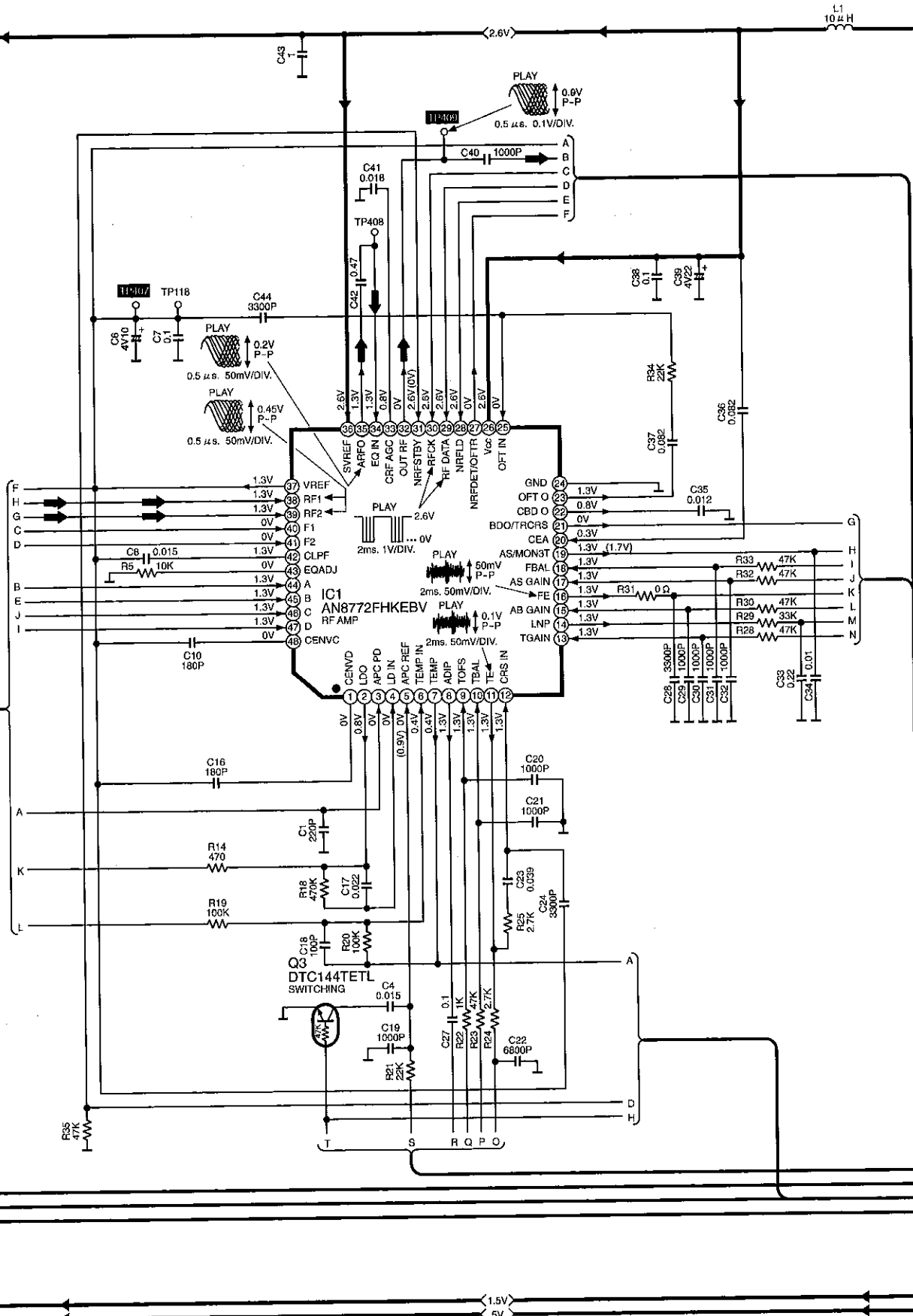

A MAIN CIRCUIT

→ POSITIVE VOLTAGE LINE

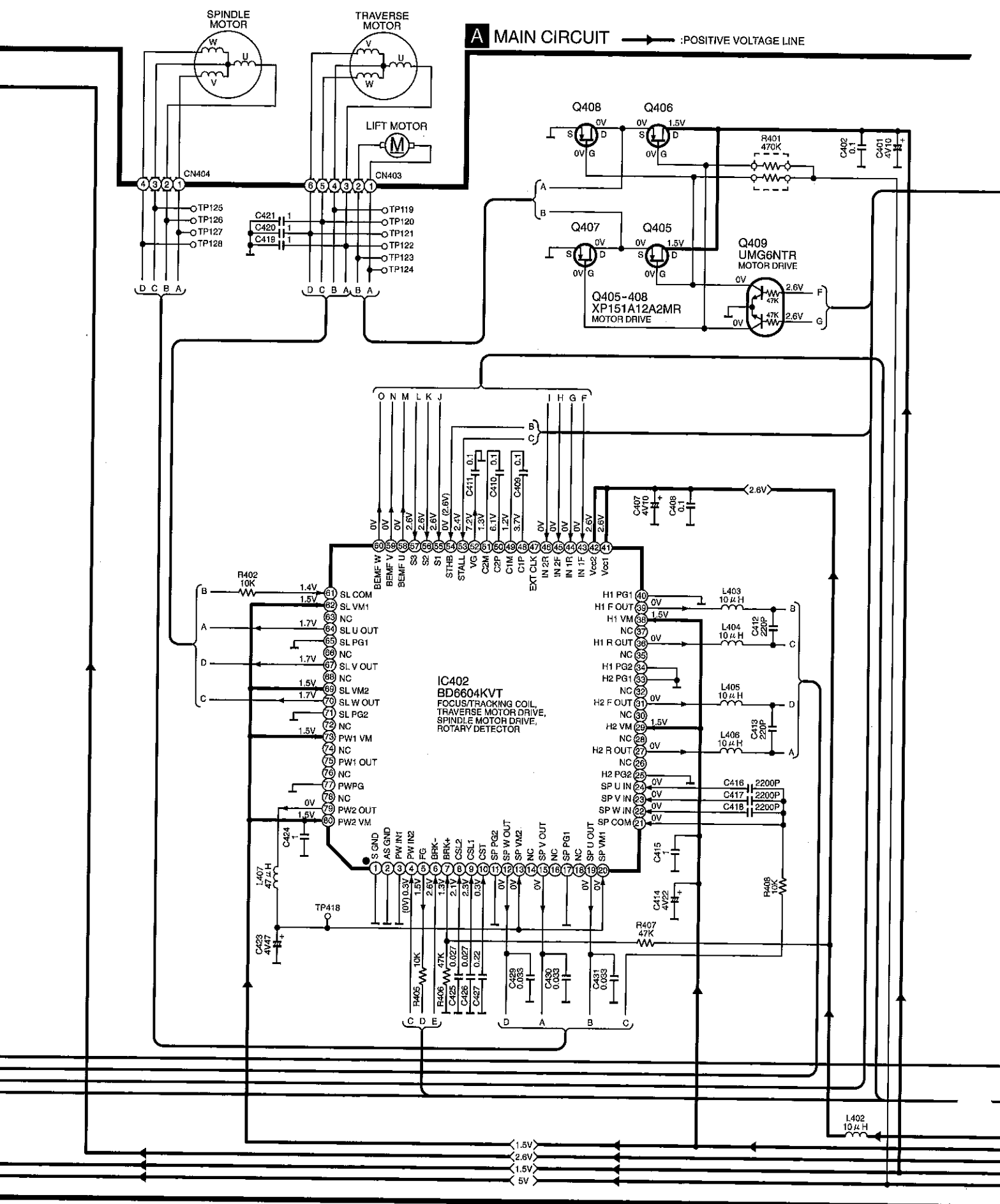

→ POSITIVE VOLTAGE LINE

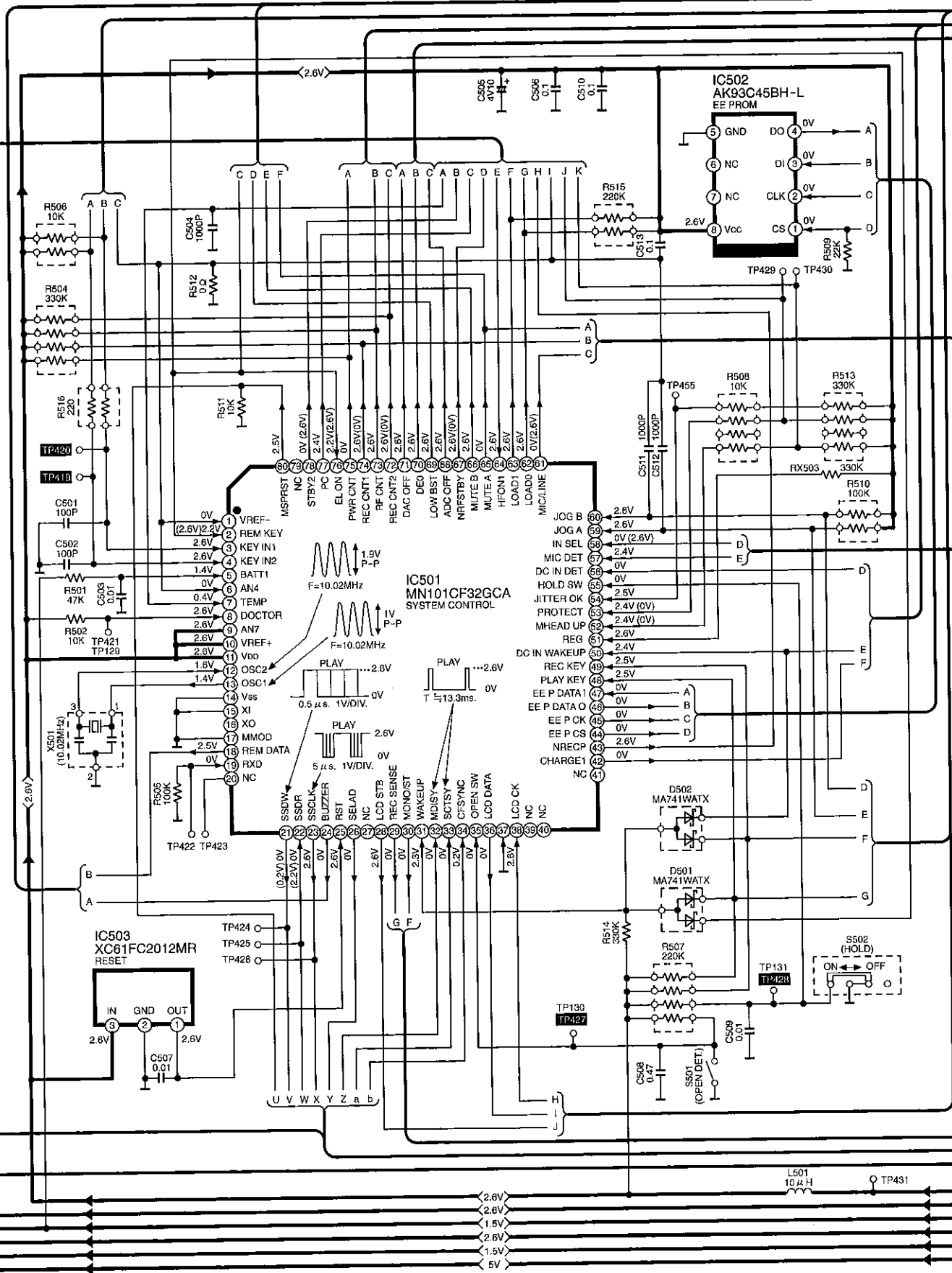

A MAIN CIRCUIT

→ : POSITIVE VOLTAGE LINE

→ : PLAYBACK SIGNAL LINE

⇌ : RECORDING SIGNAL "ANALOG" LINE

⇌ : RECORDING SIGNAL "DIGITAL" LINE

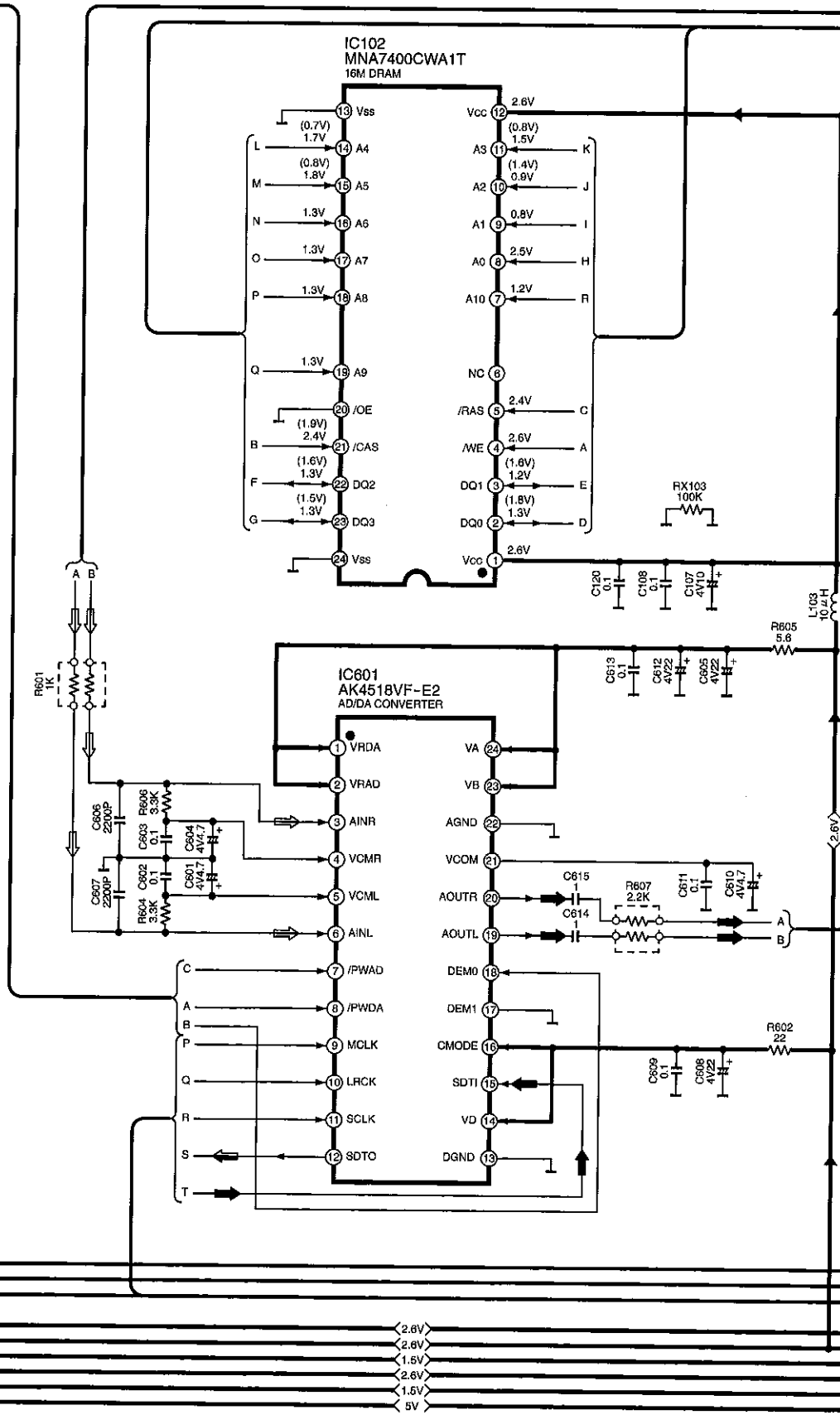

→ : POSITIVE VOLTAGE LINE → : PLAYBACK SIGNAL LINE ⇨ : RECORDING SIGNAL "DIGITAL" LINE

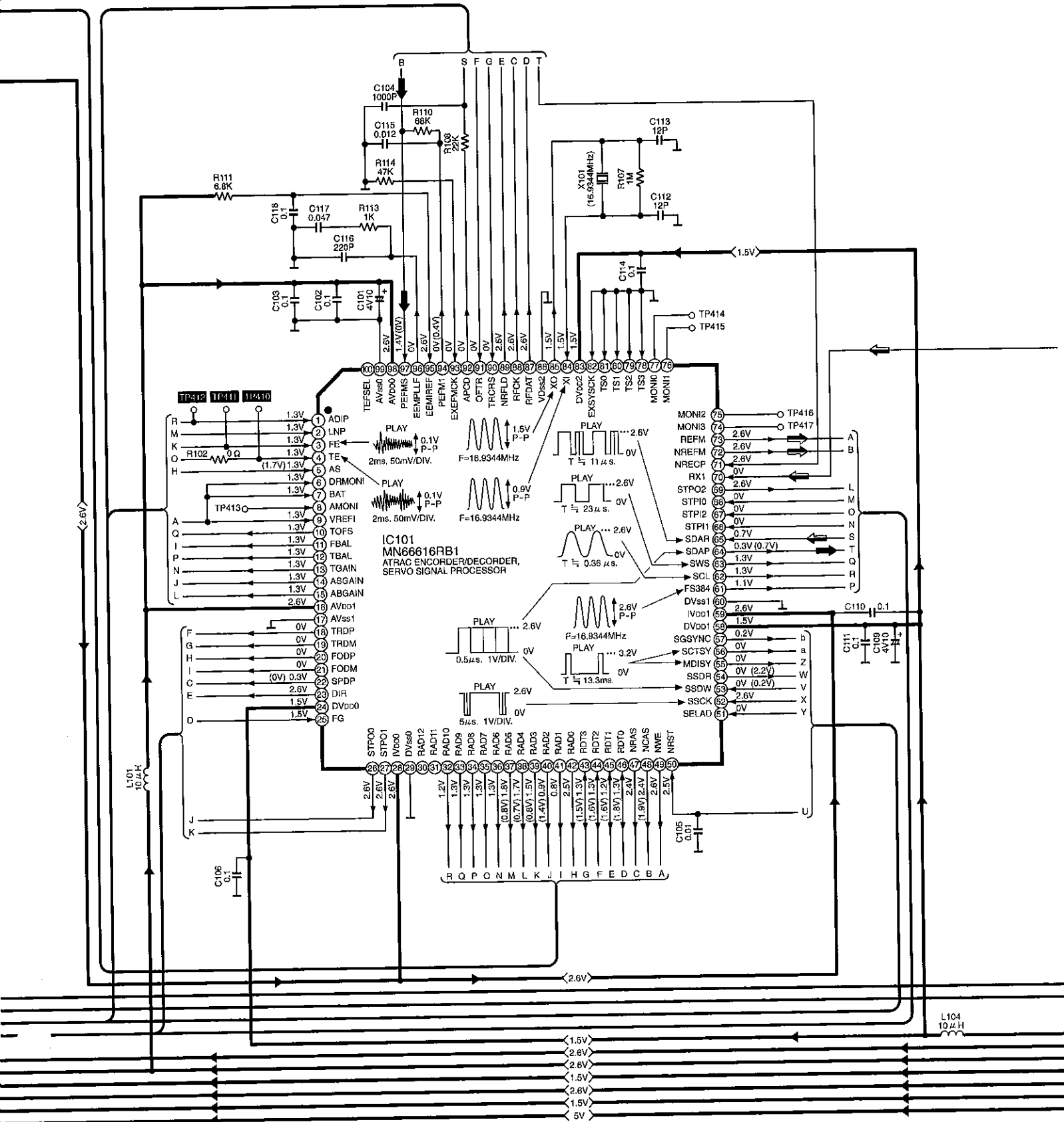

A MAIN CIRCUIT

: POSITIVE VOLTAGE LINE
 : RECORDING SIGNAL "ANALOG" LINE
 : RECORDING SIGNAL "DIGITAL" LINE
 : MIC SIGNAL LINE

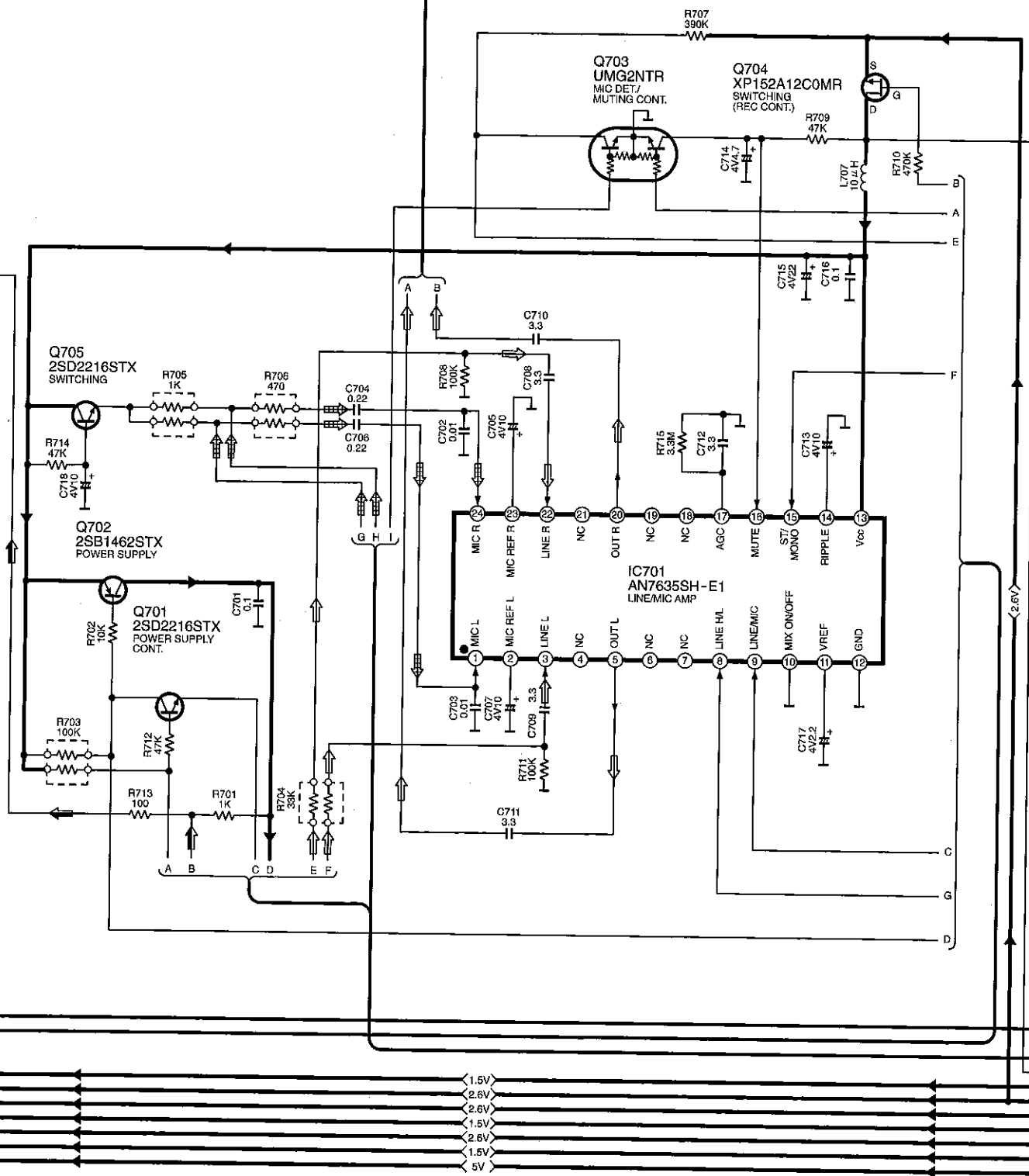

→ : POSITIVE VOLTAGE LINE → : PLAYBACK SIGNAL LINE

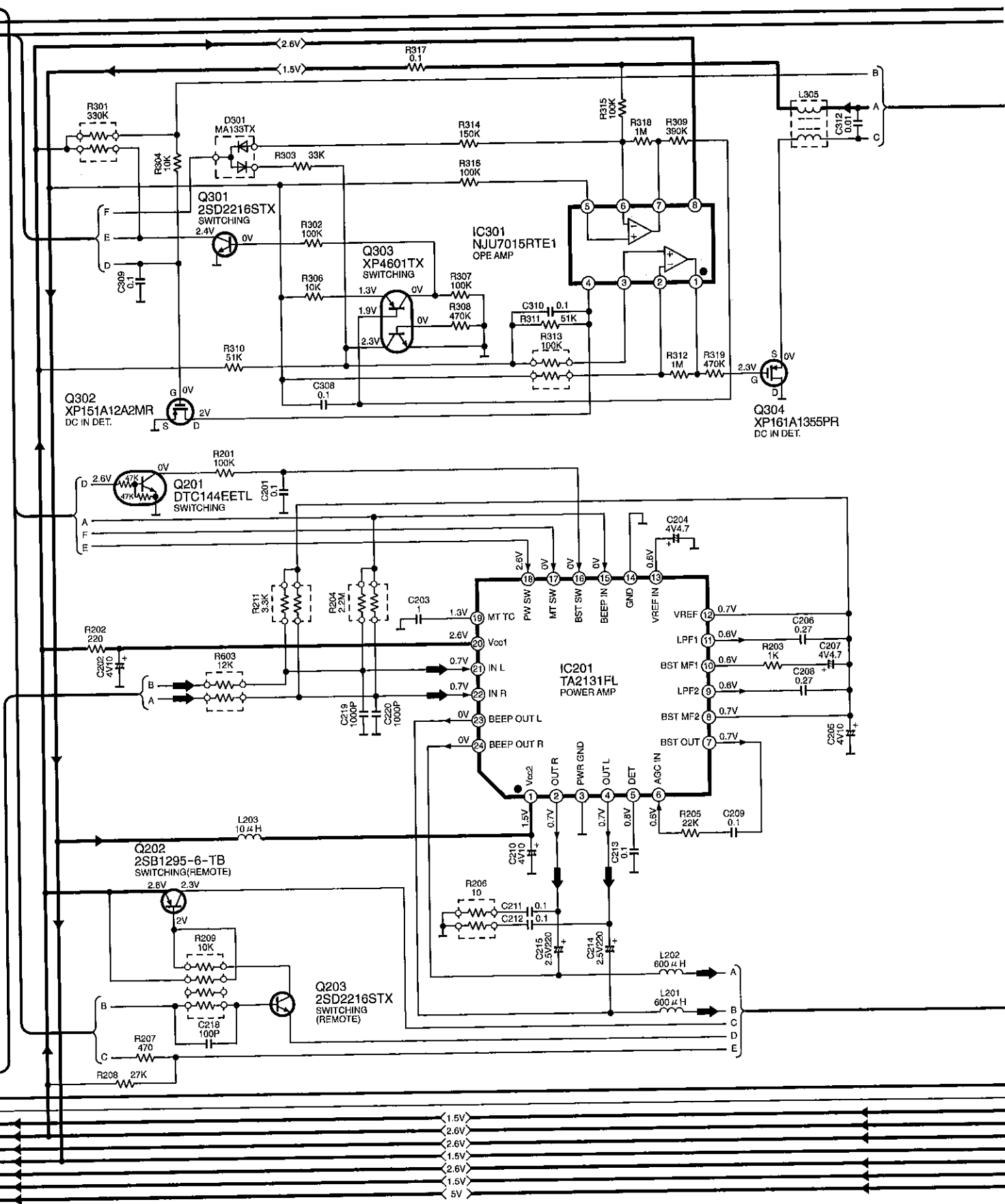

A MAIN CIRCUIT

D OPERATION CIRCUIT

- : POSITIVE VOLTAGE LINE
- ⇄ : MIC SIGNAL LINE
- ⇄ : PLAYBACK SIGNAL LINE
- ⇄ : RECORDING SIGNAL "ANALOG" LINE
- ⇄ : RECORDING SIGNAL "DIGITAL" LINE

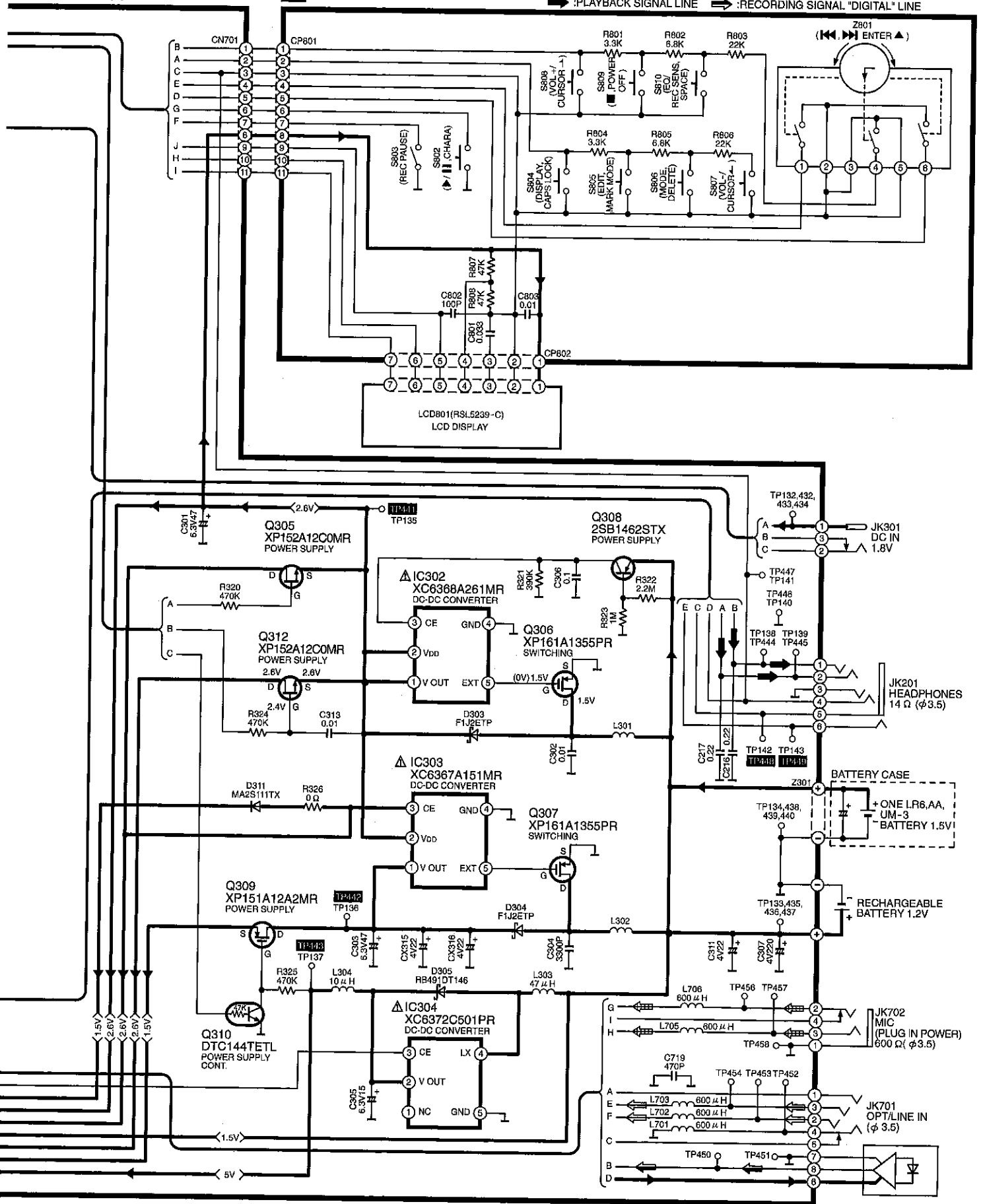

12 Printed Circuit Board Diagram

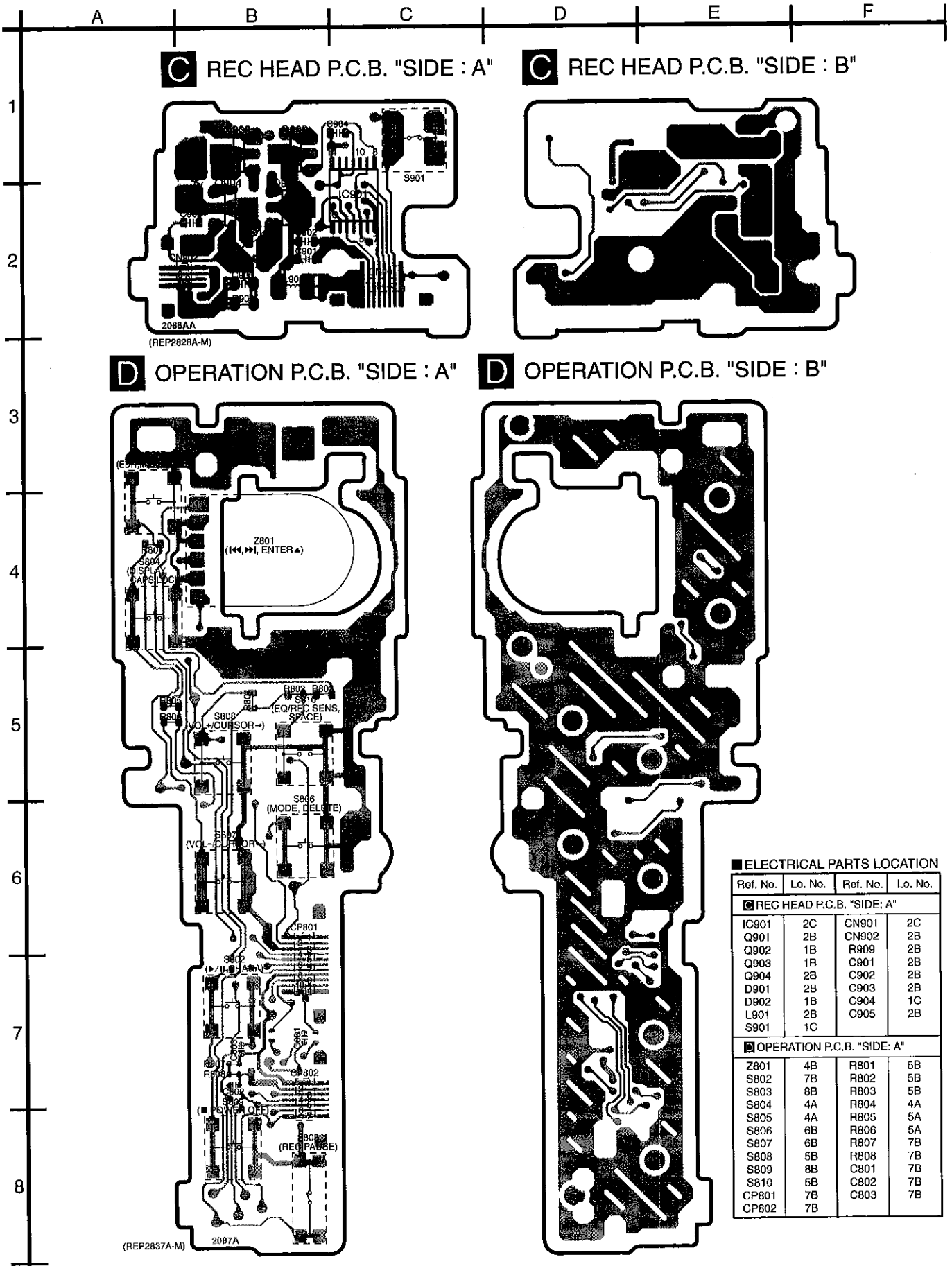

ELECTRICAL PARTS LOCATION

Ref. No.	Lo. No.	Ref. No.	Lo. No.
REC HEAD P.C.B. "SIDE : A"			
IC901	2C	CN901	2C
Q901	2B	CN902	2B
Q902	1B	R909	2B
Q903	1B	C901	2B
Q904	2B	C902	2B
D901	2B	C903	2B
D902	1B	C904	1C
L901	2B	C905	2B
S901	1C		
OPERATION P.C.B. "SIDE : A"			
Z801	4B	R801	5B
S802	7B	R802	5B
S803	8B	R803	5B
S804	4A	R804	4A
S805	4A	R805	5A
S806	6B	R806	5A
S807	6B	R807	7B
S808	5B	R808	7B
S809	8B	C801	7B
S810	5B	C802	7B
CP801	7B	C803	7B
CP802	7B		

A | B | C | D | E | F

1

A MAIN P.C.B. "SIDE : B"

2

3

4

5

6

7

8

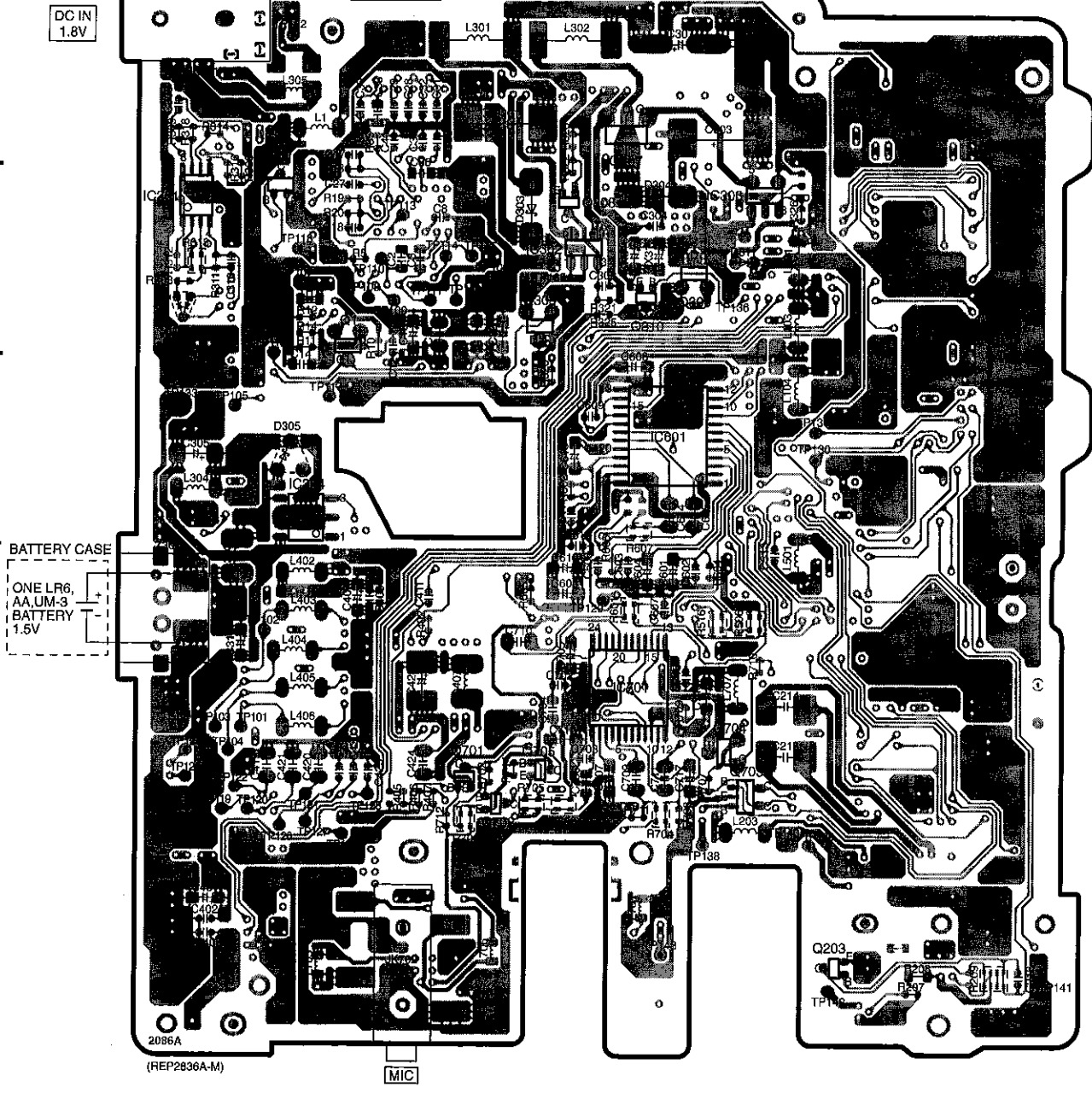

G | H | I | J | K | L

A MAIN P.C.B. "SIDE : A"

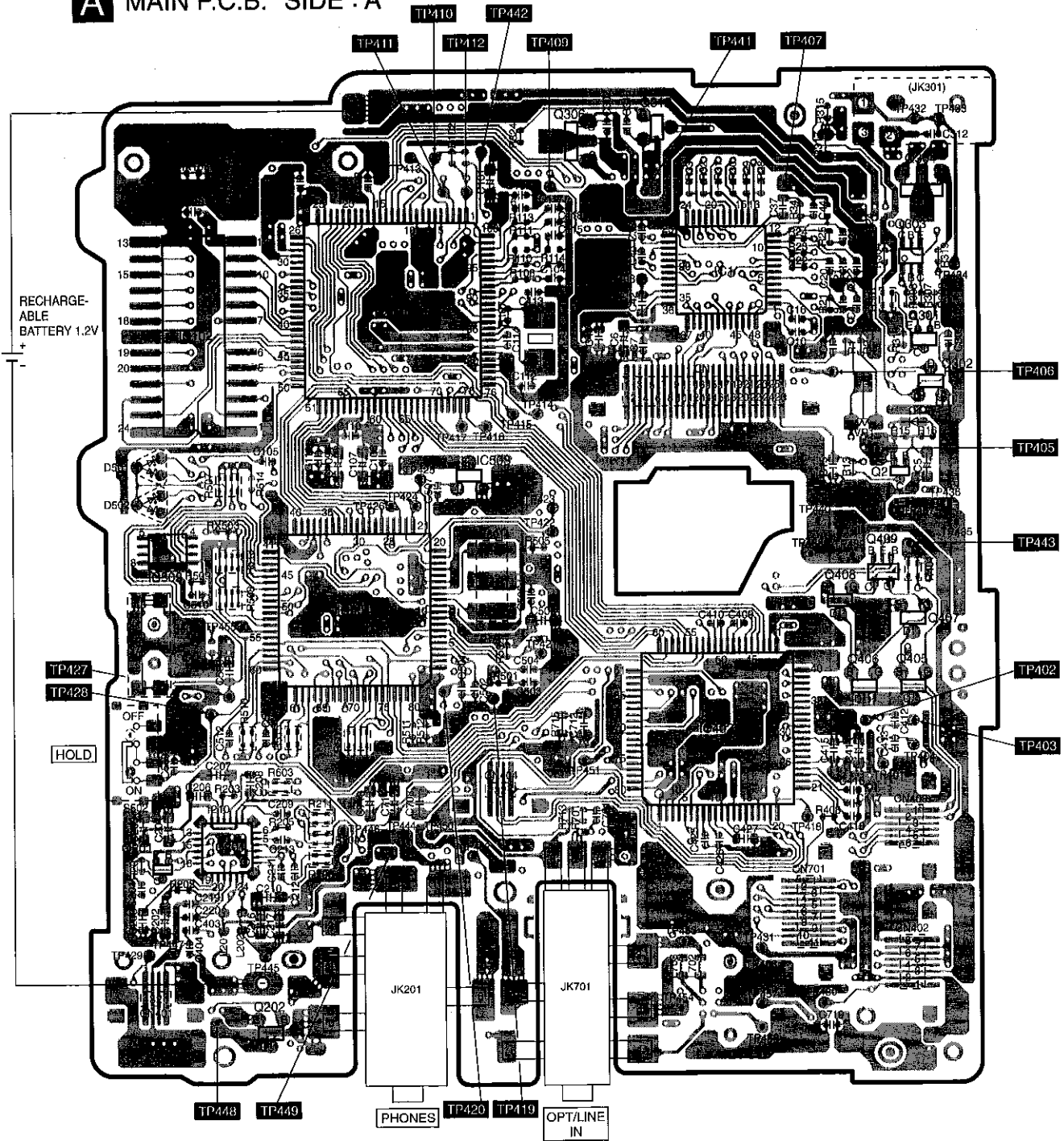

A B C D E F

ELECTRICAL PARTS LOCATION

Ref. No.	Lo. No.	Ref. No.	Lo. No.	Ref. No.	Lo. No.	Ref. No.	Lo. No.	Ref. No.	Lo. No.	Ref. No.	Lo. No.	Ref. No.	Lo. No.	Ref. No.	Lo. No.
A MAIN P.C.B. "SIDE: B"															
IC301	3B	L104	4E	TP108	3C	TP136	3D	R318	2B	R711	6D	C303	2D	C607	5D
IC302	3D	L203	6E	TP109	3C	TP137	4B	R320	4D	R712	6C	C304	3D	C608	4D
IC303	3E	L301	2C	TP110	3C	TP138	6D	R321	3D	R714	6C	C305	4B	C609	4D
IC304	4B	L302	2D	TP111	3C	TP139	6E	R322	3D	C2	3C	C306	3D	C610	4D
IC601	4D	L303	5B	TP112	3B	TP140	6E	R323	2D	C3	3C	C307	2D	C611	4D
IC701	5D	L304	4B	TP113	3C	TP141	7F	R325	3D	C8	3C	C308	2B	C612	5D
Q1	3B	L305	2B	TP114	3C	TP142	7E	R326	3E	C11	3C	C310	3B	C613	4D
Q3	3B	L402	5B	TP115	3C	TP143	7D	R402	5C	C12	3C	C311	5B	C614	4D
Q203	7E	L403	5B	TP116	3C	R5	3B	R405	6C	C13	3C	C401	6B	C615	4D
Q305	3C	L404	5B	TP117	4B	R10	3C	R406	6C	C14	4B	C402	6B	C702	5D
Q307	2D	L405	5B	TP118	3B	R11	3B	R407	6C	C17	2B	C407	5B	C703	6D
Q308	3D	L406	5B	TP119	6B	R12	3B	R506	5E	C18	3B	C408	5C	C704	5D
Q309	3D	L407	5C	TP120	6B	R14	3B	R516	5D	C27	3B	C411	5C	C705	5D
Q310	3D	L501	5E	TP121	6B	R18	3B	R601	5D	C28	2C	C419	6B	C706	6D
Q701	6C	L701	6D	TP122	6B	R19	3B	R602	4D	C29	2C	C420	6B	C707	6D
Q702	6C	L705	7B	TP123	6B	R20	3B	R604	5D	C30	2B	C421	6B	C709	6D
Q703	6E	L706	7B	TP124	6B	R35	2C	R605	5C	C31	2C	C423	5C	C710	5D
Q704	6D	L707	5E	TP125	6B	R207	7E	R606	5D	C32	2C	C424	6C	C711	6C
Q705	6C	Z301	5B	TP126	6B	R208	7E	R607	4D	C33	2C	C429	6C	C715	5D
D301	3B	JK301	2B	TP127	6B	R209	7F	R702	6C	C34	2C	C430	6B	C716	5D
D303	3C	JK702	7B	TP128	6C	R303	3B	R703	6C	C35	2C	C431	6B	C717	6D
D304	3D	TP101	5B	TP129	5D	R306	3B	R704	6D	C36	3C	C513	5E	C718	6D
D305	4B	TP102	5B	TP130	4E	R309	2B	R705	6C	C39	3C	C601	5D	CX315	3D
D311	3E	TP103	5B	TP131	4E	R311	3B	R706	6D	C41	2C	C602	5D	CX316	3D
TH1	3B	TP104	6B	TP132	2B	R312	3B	R707	6D	C214	5E	C603	5D	CX405	7B
L1	2B	TP105	4B	TP133	4B	R313	3B	R708	6D	C215	6E	C604	5D		
L101	3E	TP106	3C	TP134	5B	R314	2B	R709	5D	C218	7F	C605	5D		
L103	3E	TP107	3B	TP135	6B	R316	3B	R710	5E	C301	2C	C606	5D		
A MAIN P.C.B. "SIDE: A"															
IC1	3K	S501	5G	TP422	4J	TP454	7J	R204	6H	R715	5J	C110	4H	C404	6H
IC101	3I	S502	5G	TP423	4J	TP455	6H	R205	6H	RX103	2H	C111	4H	C409	5K
IC102	3H	CN1	3J	TP424	4I	TP456	7K	R206	6H	RX503	4H	C112	3I	C410	5K
IC201	6H	CN401	7G	TP425	4I	TP457	7K	R211	6H	C1	3K	C113	3I	C412	5L
IC402	5J	CN402	6L	TP426	4I	TP458	7K	R301	3K	C4	3K	C114	3I	C413	5K
IC501	5H	CN403	6L	TP427	5H	R1	3K	R302	3L	C5	4L	C115	2J	C414	5K
IC502	4G	CN404	6I	TP428	5H	R2	3K	R304	3K	C6	3J	C116	2J	C415	5K
IC503	4I	CN701	6K	TP429	6G	R13	4K	R307	3L	C7	3J	C117	2J	C416	6K
Q2	4L	JK201	7I	TP430	7K	R15	4L	R308	3L	C10	3K	C118	2J	C417	6K
Q201	6G	(JK301)	2L	TP431	6K	R16	4L	R310	3L	C15	4K	C120	2H	C418	6K
Q202	7H	JK701	7J	TP432	2L	R21	3K	R315	2K	C16	3K	C201	6G	C425	6J
Q301	3L	TP401	5K	TP433	2L	R22	3K	R317	2K	C19	3K	C202	6G	C426	6K
Q302	3L	TP402	5K	TP434	3L	R23	3K	R319	3L	C20	3K	C203	6G	C427	6K
Q303	3L	TP403	5L	TP435	4L	R24	2K	R324	2I	C21	3K	C204	6G	C501	5I
Q304	2L	TP404	5L	TP436	4L	R25	2K	R401	4L	C22	3K	C205	6G	C502	5I
Q306	2J	TP405	4K	TP437	4L	R28	2K	R408	6K	C23	2K	C206	6H	C503	5I
Q312	2J	TP406	3K	TP438	4K	R29	2K	R501	5I	C24	2K	C207	5H	C504	5I
Q405	5L	TP407	2K	TP439	4K	R30	2K	R502	5I	C37	2K	C208	5H	C505	5J
Q406	5K	TP408	3J	TP440	4K	R31	2K	R504	5H	C38	2J	C209	6H	C506	4I
Q407	5L	TP409	2J	TP441	2J	R32	2J	R505	4J	C40	3J	C210	6H	C507	4I
Q408	4K	TP410	2I	TP442	2I	R33	2J	R507	4H	C42	3J	C211	6H	C508	5H
Q409	4K	TP411	2I	TP443	4L	R34	2K	R508	4H	C43	3J	C212	6H	C509	5G
D1	3L	TP412	2I	TP444	6I	R102	2I	R509	4H	C44	2K	C213	6H	C510	4H
D501	4G	TP413	2I	TP445	6H	R107	3I	R510	5H	C101	2I	C216	6H	C511	5H
D502	4G	TP414	3J	TP446	6H	R108	3I	R511	5I	C102	2I	C217	6H	C512	5H
VR1	3K	TP415	3I	TP447	6G	R110	3I	R512	5I	C103	2I	C219	6H	C701	6J
L201	6H	TP416	4I	TP448	7H	R111	2I	R513	4H	C104	3J	C220	6H	C708	6I
L202	6H	TP417	4I	TP449	6I	R113	2I	R514	4H	C105	4H	C302	2J	C712	5J
L702	7J	TP418	6K	TP450	6I	R114	3J	R515	5H	C106	2H	C309	3L	C713	6I
L703	7J	TP419	5I	TP451	5J	R201	6G	R603	5H	C107	4I	C312	2L	C714	6I
X101	3J	TP420	5I	TP452	6I	R202	6H	R701	6J	C108	4I	C313	2J	C719	7K
X501	4I	TP421	5J	TP453	6J	R203	6H	R713	6J	C109	4H	C403	6H		
B SWITCH P.C.B. "SIDE: A"															
S1101	8B														

B SWITCH P.C.B. "SIDE: A"

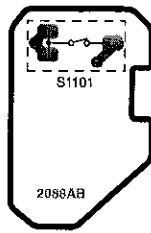

(REP2826A-M)

B SWITCH P.C.B. "SIDE: B"

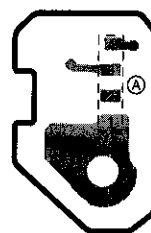

13 Block Diagram

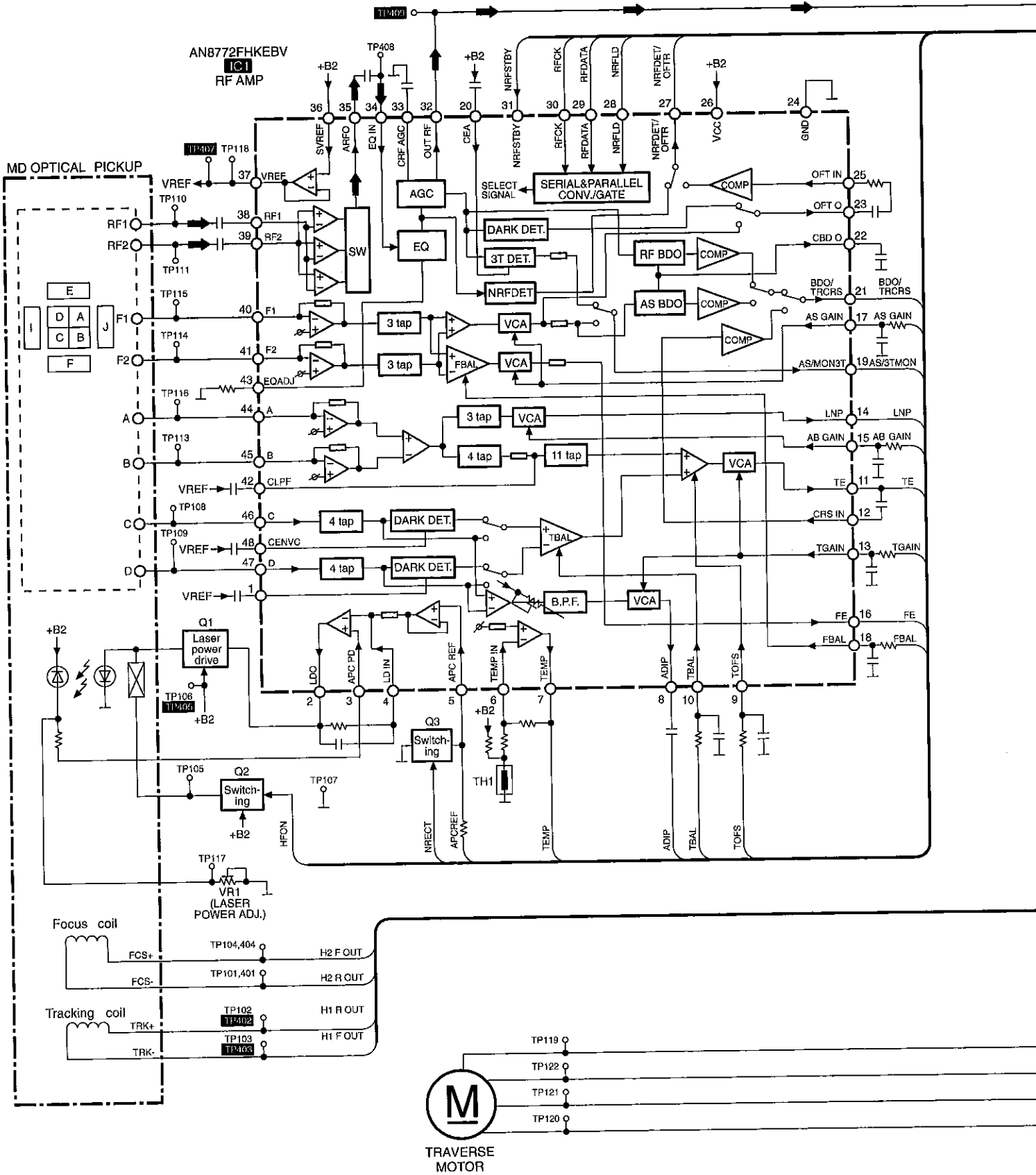

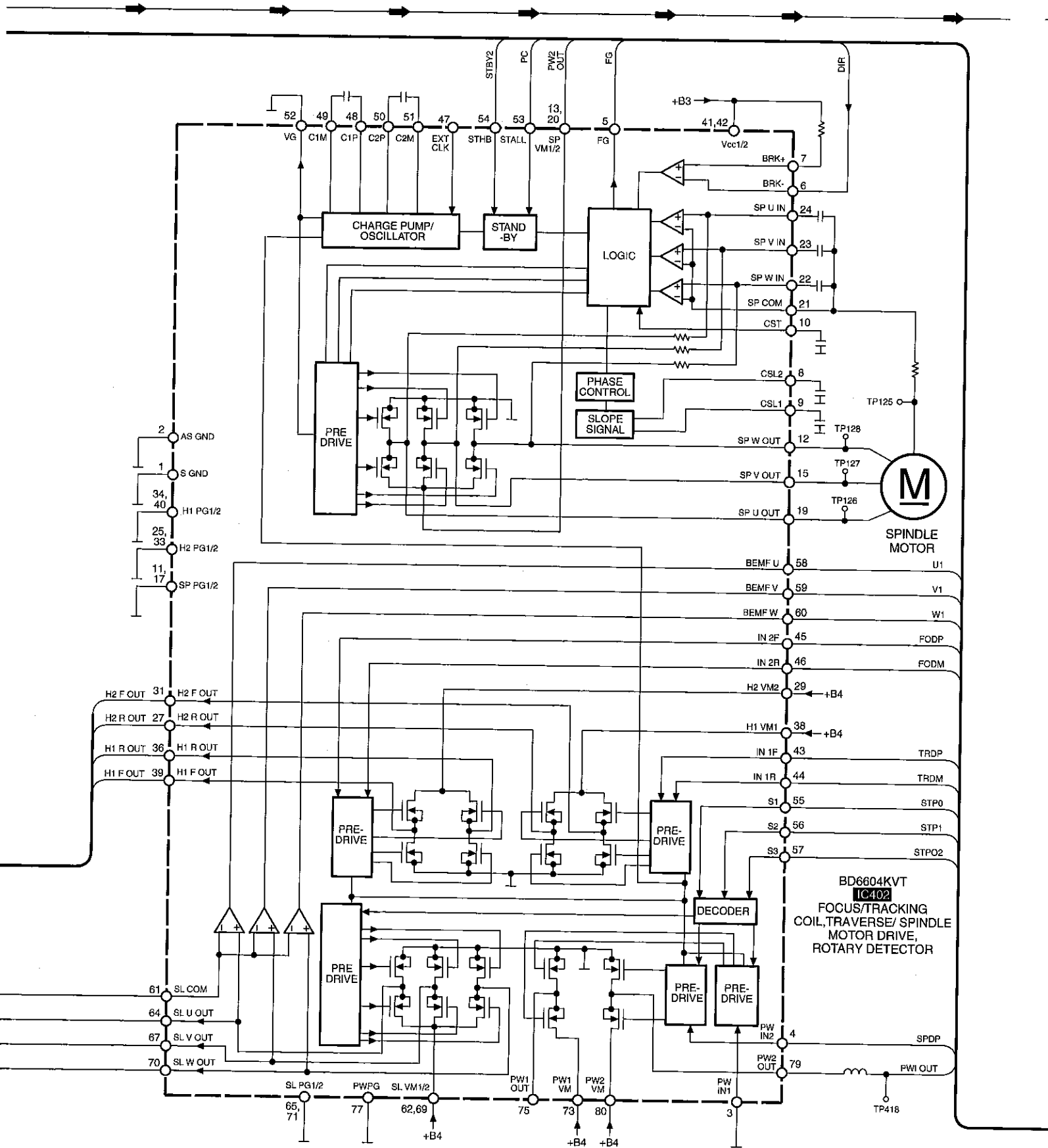

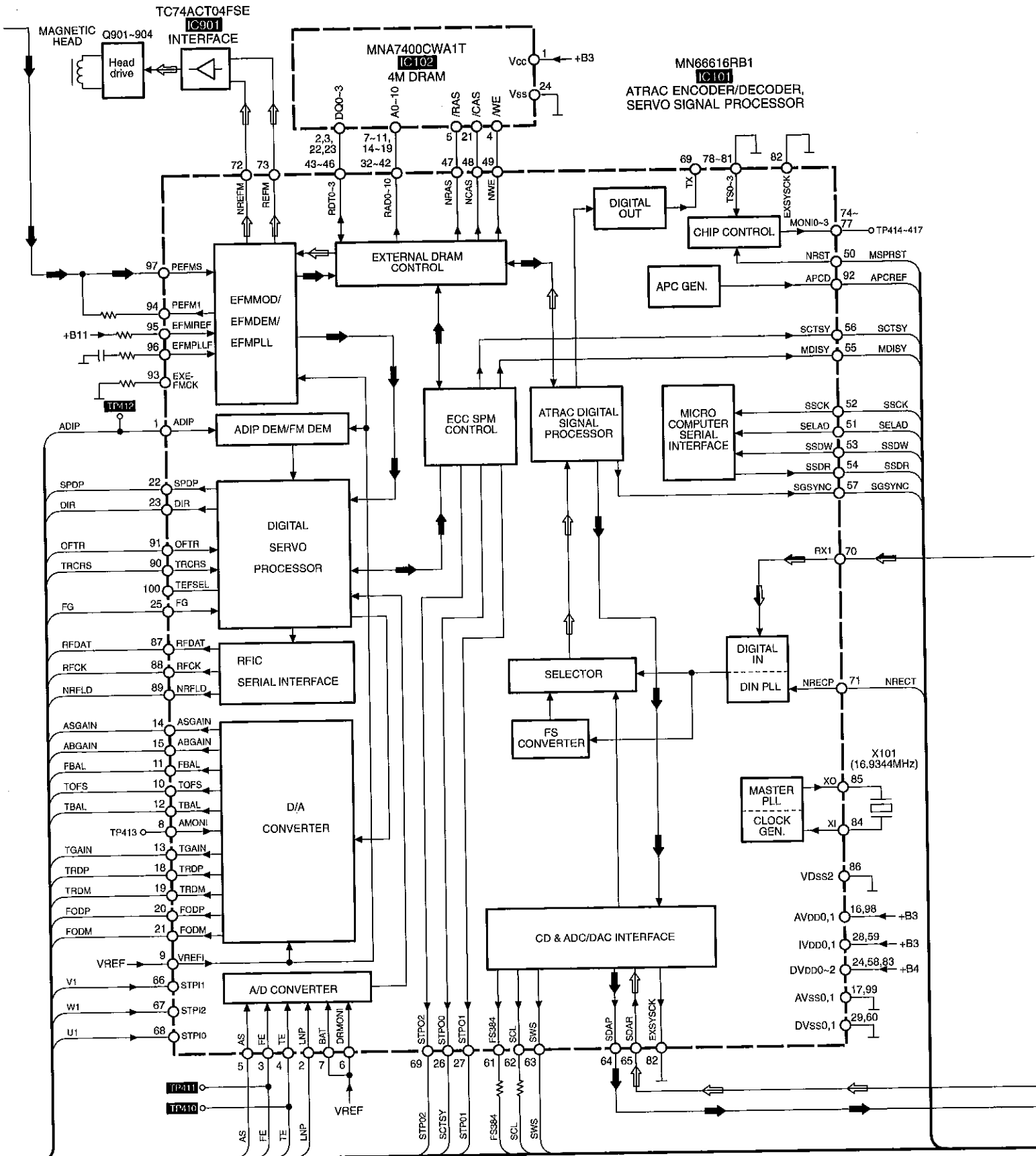

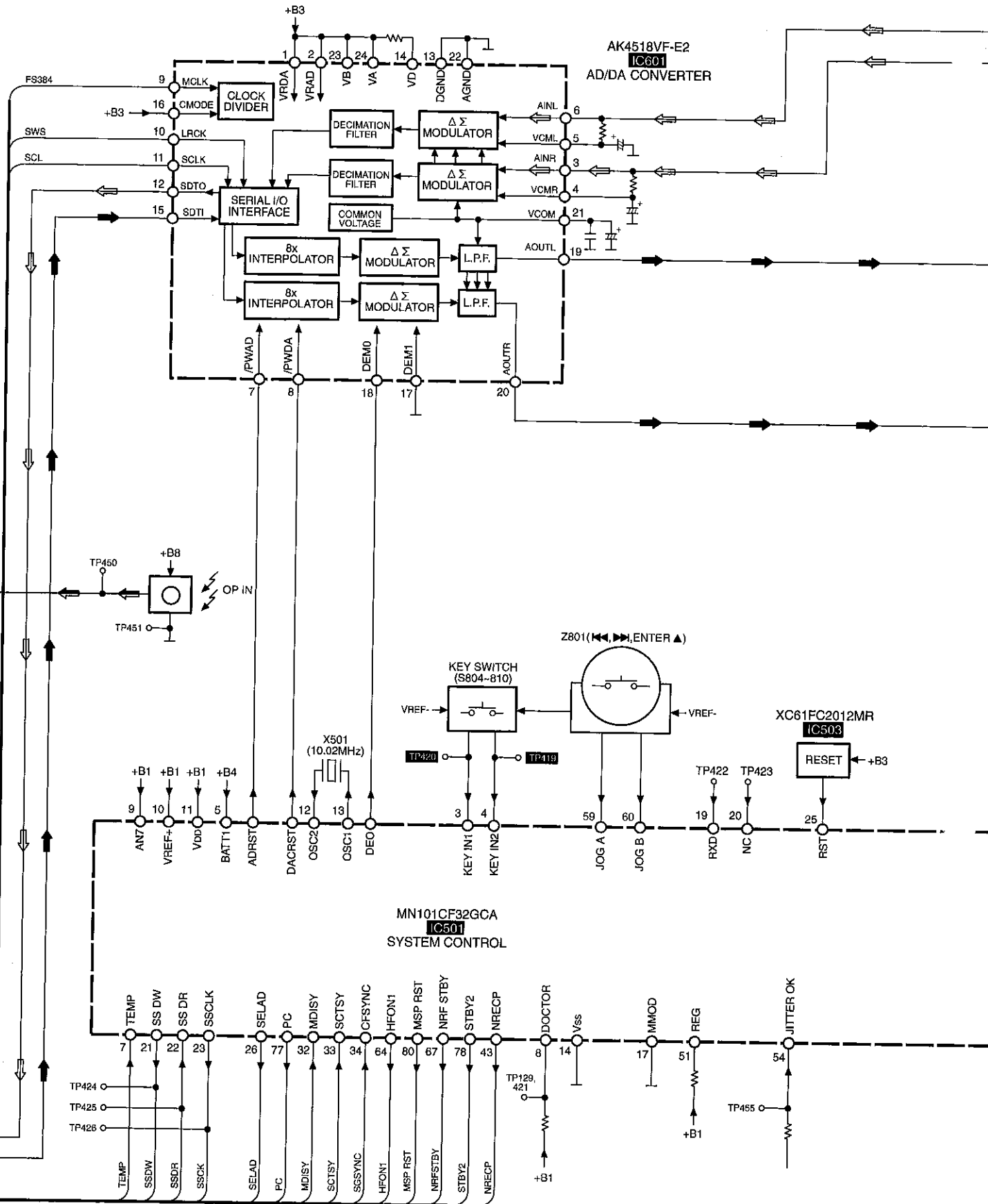

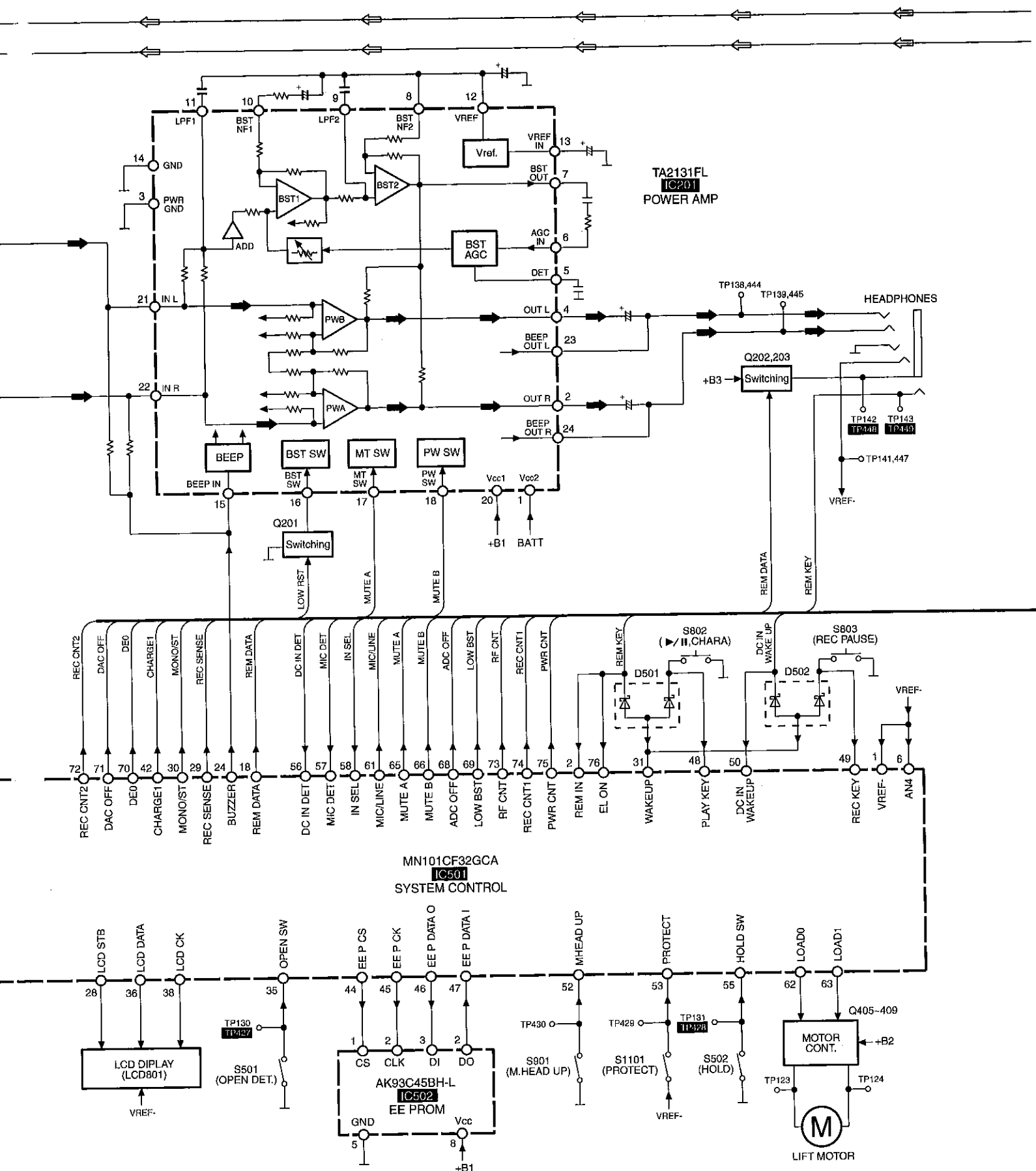

NOTE:
 → : PLAYBACK SIGNAL LINE
 ⇨ : RECORDING SIGNAL "ANALOG" LINE
 ⇨ : RECORDING SIGNAL "DIGITAL" LINE
 ⇨ : MIC SIGNAL LINE

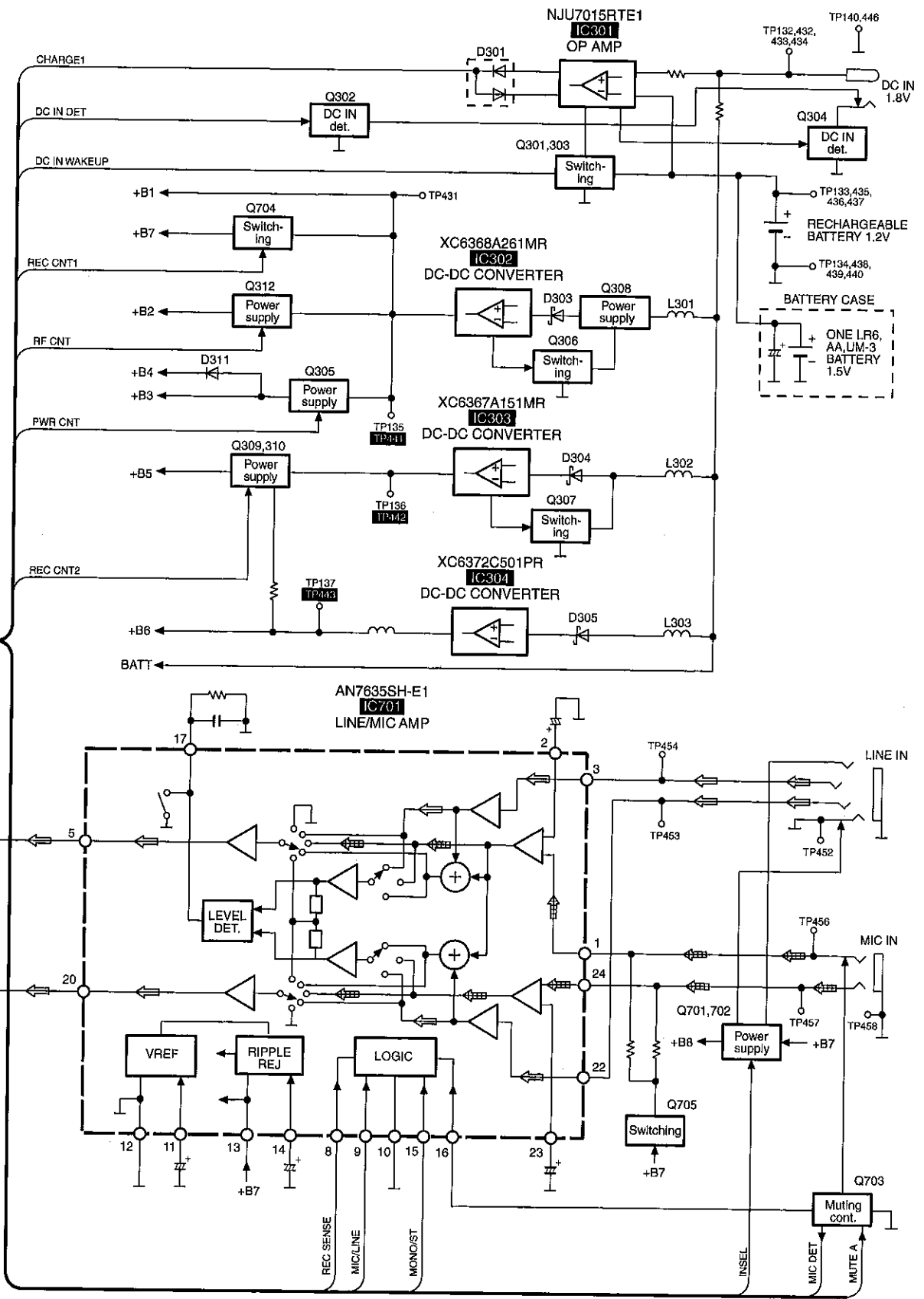

14 Wiring Connection Diagram

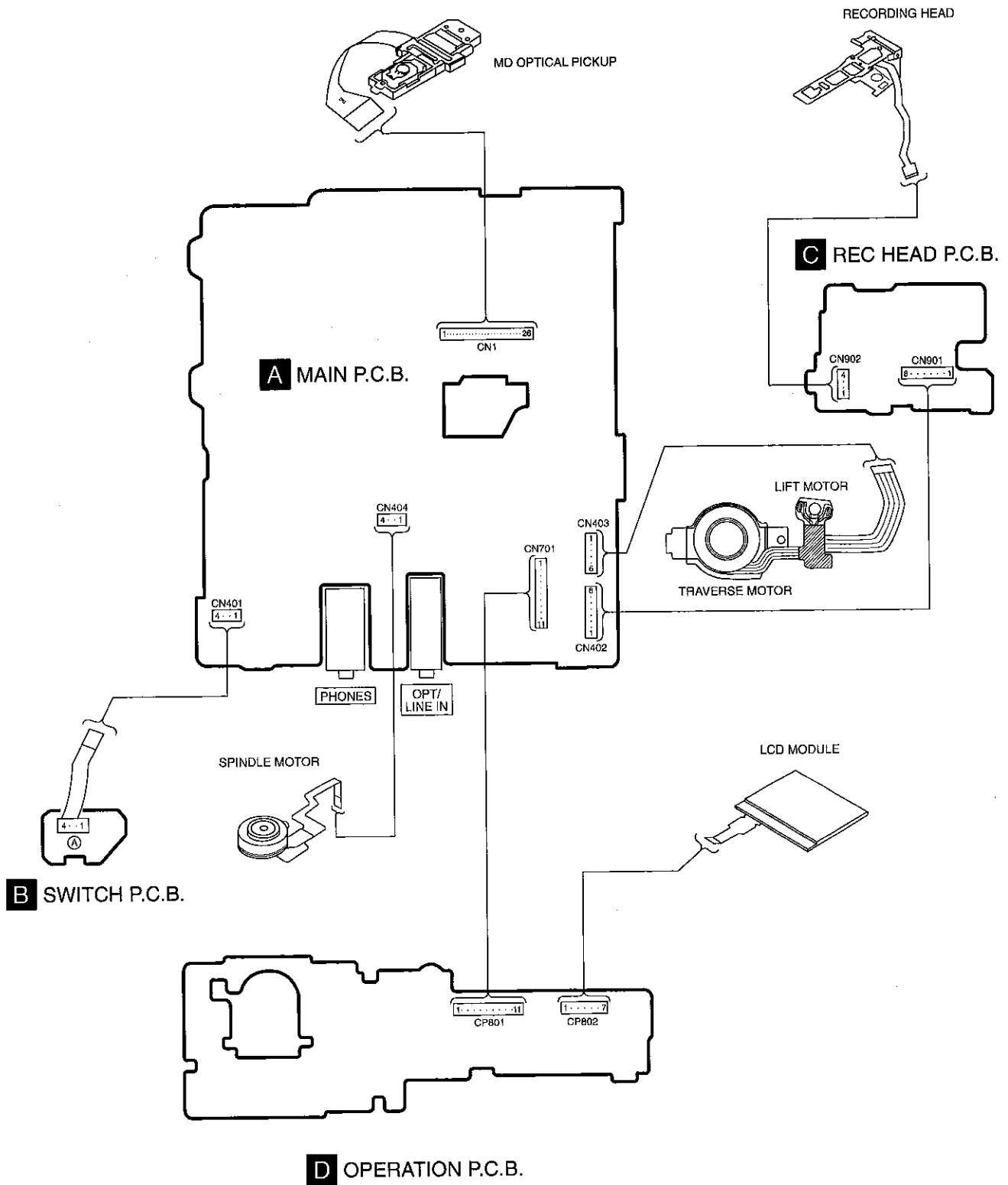

15 Terminal Function of IC's

15.1. IC1 (AN8772FHKEBV) : RF AMP

Pin No.	Mark	I/O Division	Function
1	CENVD	I	D signal det. capacitor input terminal
2	LDO	O	Laser amp output terminal
3	APCPD	I	Photo diode light quantity det. input terminal
4	LD IN	I	Laser amp reverse input terminal

Pin No.	Mark	I/O Division	Function
5	APC REF	I	APC amp reference voltage input terminal
6	TEMP IN	I	Temperature sensor amp input terminal

Pin No.	Mark	I/O Division	Function
7	TEMP	O	Temperature sensor amp output terminal
8	ADIP	O	ADIP signal output terminal
9	TOFS	I	Tracking error offset adjustment terminal
10	TBAL	I	Tracking ballance adjustment input terminal
11	TE	O	Tracking error signal output terminal
12	CRS IN	I	Track cross input terminal
13	TGAIN	I	Tracking gain adjustment input terminal
14	LNP	O	Lens position signal output terminal
15	AB GAIN	I	APP compensation signal gain adjustment terminal
16	FE	O	Focus error signal output terminal
17	AS GAIN	I	AS gain adjustment input terminal
18	FBAL	I	Focus ballance adjustment input terminal
19	AS/MON3T	O	AS/3TMON signal output terminal
20	CEA	I	3T envelope det. capacitor connection terminal (Connected to power supply through capacitor)
21	BDO/TRCRS	O	BDO/Track cross signal output terminal
22	CBD O	O	BDO detection capacitor connection terminal (Connected to GND through capacitor)
23	OFT O	O	Off track detection signal output terminal
24	GND	—	GND terminal
25	OFT IN	I	Off track detection signal input terminal
26	VCC	I	Power supply terminal (+3V)
27	NRFDET/OFTR	O	NRFDET/off track signal output terminal
28	NRFLD	I	Serial command latch signal input terminal
29	RF DATA	I	Serial command data signal input terminal
30	RFCK	I	Serial command clock input terminal
31	NRFSTBY	I	Standby control signal input terminal
32	OUT RF	O	EFM signal output terminal
33	CRF AGC	—	RFAGC capacitor connection terminal (Connected to GND through capacitor)
34	EQ IN	I	EQ input terminal
35	ARFO	O	RF amp. output terminal
36	SVREF	I	Reference voltage input terminal
37	VREF	I	Reference voltage input terminal
38	RF1	I	RF1 signal input terminal
39	RF2	I	RF2 signal input terminal
40	F1	I	F1 signal input terminal
41	F2	I	F2 signal input terminal
42	CLPF1	I	APP compensation LPF capacitor input terminal
43	CLPF2	—	RF equalizer adjustment resistor connection terminal (Connected to power supply through resistor)
44~47	A~D	I	Main beam A~D signal input terminal
48	CENVC	I	Beam E signal detection capacitor input terminal

15.2. IC101 (M6616RB1) : ATRAC ENCODER/DECORDER, SERVO SIGNAL PROCESSOR

Pin No.	Mark	I/O Division	Function
1	ADIP	I	ADIP FM signal input terminal
2	LNP	I	Lens position signal input terminal
3	FE	I	Focus error signal input terminal
4	TE	I	Tracking error signal input terminal
5	AS	I	AS signal input terminal
6	DRMONI	I	Drive voltage monitor input terminal
7	BAT	I	Battery power supply terminal
8	AMONI	—	Servo analog monitor signal output (Not used, open)
9	VREFI	I	Reference voltage input terminal
10	TOFS	O	Tracking off-set adjustment output terminal
11	FBAL	O	Focus balance adjustment output terminal
12	TBAL	O	Tracking balance adjustment output terminal
13	TGAIN	O	TE error gain adjustment output terminal
14	ASGAIN	O	Main beam amp gain adjustment output terminal
15	ABGAIN	O	APP adjustment output terminal
16	AV _{DD1}	I	Power supply terminal
17	AV _{SS1}	—	GND terminal
18	TRDP	O	Tracking drive (+) PWM signal output terminal
19	TRDM	O	Tracking drive (-) PWM signal output terminal
20	FODP	O	Focus drive (+) PWM signal output terminal
21	FODM	O	Focus drive (-) PWM signal/focus, tracking ON/OFF signal output terminal
22	SPDP	O	Spindle drive (+) PWM signal output terminal
23	DIR	O	Spindle drive (-) PWM signal output terminal
24	DV _{DD0}	I	Power supply terminal
25	FG	I	FG input terminal
26	STPO0	O	Stepper drive signal 0 output terminal
27	STPO1	O	Stepper drive signal 1 output terminal
28	IVDD0	I	Power supply terminal for I/O pad
29	DV _{SS0}	—	GND terminal
30	RAD12	O	DRAM address output terminal (Not used, open)
31	RAD11	O	DRAM address output terminal
32~42	RAD10~RAD0	O	DRAM address output terminal
43~46	RDT3~RDT0	I/O	DRAM data input/output terminal
47	NRAS	O	DRAM row address strobe output terminal
48	NCAS	O	DRAM culum address strobe output terminal
49	NWE	O	DRAM write enable output terminal
50	NRST	I	Reset signal input terminal
51	SELAD	I	MSP/MDA,I/F address select input terminal ("H" Address)
52	SSCK	I	MSP/MDA,I/F clock input terminal
53	SSDW	I	MSP/MDA,I/F write data input terminal
54	SSDR	O	MSP/MDA,I/F read data output terminal
55	MDISY	O	Leader synchronous signal output

Pin No.	Mark	I/O Division	Function
56	SCTSY	O	ADIP synchronous noise output terminal
57	SGSYNC	O	Frame synchronous signal output terminal
58	DVDD1	I	Power supply terminal
59	IVDD1	—	Power supply terminal for I/O pad
60	DVss1	—	GND terminal
61	FS384	O	384 Fs output terminal
62	SCL	O	Bit clock output terminal
63	SWS	O	Word clock output terminal
64	SDAP	O	Audio data output terminal
65	SDAR	I	Audio data input terminal
66	STPI1	I	Stepper status 1 input terminal
67	STPI2	I	Stepper status 2 input terminal
68	STPI0	I	Stepper status 0 input terminal
69	STPO2	O	Stepper drive signal 2 output terminal
70	RX1	I	Digital audio interface signal 1 input terminal
71	NRECP	I	Amp. Play/Rec switching signal input terminal
72	NREFM	O	EFM modulation inverted output terminal
73	REFM	O	EFM modulation inverted output terminal
74	MONI3	O	Monitor signal output (Not used)
75	MONI2	O	Monitor signal output (Not used)
76	MONI1	O	Monitor signal output (Not used)
77	MONI0	O	Monitor signal output (Not used)
78	TS3	---	Not used, connected to GND
79	TS2	---	Not used, connected to GND
80	TS1	---	Not used, connected to GND
81	TS0	---	Not used, connected to GND
82	EXSYSCK	I	External system clock input terminal (Not used, connected to GND)
83	DVDD	I	Power supply terminal
84	XI	I	Crystal oscillator input terminal (F=16.9344MHz)
85	XO	O	Crystal oscillator output terminal (F=16.9344MHz)
86	VDss2	---	GND terminal
87	RFDAT	O	RF serial data output terminal
88	RFCK	O	RF serial clock output terminal
89	NRFLD	O	RF serial load output terminal
90	TRCRS	I	Track cross input terminal
91	OFTR	I	Off-track signal input terminal
92	APCD	O	Laser power PWM output terminal
93	EXEFMCK	I	External FM clock input terminal (Not used, connected to GND through resistor)
94	PEFM1	O	EFM loop filter output terminal
95	EFMIREF	I	EFM PLL reference current input terminal
96	EFMPLLF	O	EFM PLL filter output terminal
97	PEFMS	I	EFM signal input terminal
98	AV _{DD} 0	I	Power supply terminal
99	AVss0	---	GND terminal
100	TEFSEL	---	Tracking error signal output terminal

15.3. IC301 (BD6604KVT) : FOCUS/TRACKING COIL, TRAVERSE MOTOR DRIVE, SPINDLE MOTOR DRIVE, ROTARY DETECTOR

Pin No.	Mark	I/O Division	Function
1	S GND	---	GND terminal
2	AS GND	---	
3	PW IN 1	---	Not used, connected to GND
4	PW IN 2	I	Half bridge input terminal
5	FG	O	Speed pulse output terminal
6	BRK-	I	Brake comparator- input terminal
7	BRK+	I	Brake comparator+ input terminal (Connected to GND and power supply through resistor)
8	CSL2	I	Slope capacitor connect terminal (Connected to GND through capacitor)
9	CSL1		
10	CST	I	Connected to GND through capacitor
11	SP PG2	---	GND terminal
12	SP W OUT	O	Spindle motor coil (W) output terminal
13	SP VM2	I	Power supply terminal for part of spindle power
14	NC	---	Not used, open
15	SP V OUT	O	Spindle motor coil (V) output terminal
16	NC	---	Not used, open
17	SP PG1	---	GND terminal
18	NC	---	Not used, open
19	SP U OUT	O	Spindle motor coil (U) output terminal
20	SP VM1	I	Power supply terminal for part of spindle power
21	SP COM	I	Spindle motor coil center input terminal
22	SP W IN	I	Roter position detect comparator (W) input terminal
23	SP V IN	I	Roter position detect comparator (V) input terminal
24	SP U IN	I	Roter position detect comparator (U) input terminal
25	H2 PG2	---	GND terminal
26	NC	---	Not used, open
27	H2 R OUT	I	H bridge 2 reverse output terminal
28	NC	---	Not used, open
29	H2 VM	I	Power supply terminal
30	NC	---	Not used, open
31	H2 F OUT	O	H bridge 2 forward output terminal
32	NC	---	Not used, open
33	H2 PG1	I	GND terminal
34	H1 PG2		
35	NC	---	Not used, open
36	H1 R OUT	O	H bridge 1 reverse output terminal
37	NC	---	Not used, open
38	H1 VM	I	Power supply terminal
39	H1 F OUT	O	H bridge 1 forward output terminal
40	H1 PG1	---	GND terminal
41	VCC1	I	Power supply terminal
42	VCC2		
43	IN 1F	I	H bridge 1 forward input terminal
44	IN 1R	I	H bridge 1 reverse input terminal
45	IN 2F	I	H bridge 2 reverse input terminal
46	IN 2R		
47	EXT CLK	I	Not used, open

Pin No.	Mark	I/O Division	Function
48	C1P	—	Charge pump capacitor 1(+) connect terminal
49	C1M	—	Charge pump capacitor 1(-) connect terminal
50	C2P	—	Charge pump capacitor 2(+) connect terminal
51	C2M	—	Charge pump capacitor 2(-) connect terminal
52	VG	O	Charge pump output terminal (Connected to GND through capacitor)
53	STALL	I	Stand by input terminal
54	STHB	I	H1, H2 bridge mute terminal
55	S1	I	Stepping decoder 1 input terminal
56	S2	I	Stepping decoder 2 input terminal
57	S3	I	Stepping decoder 3 input terminal
58	BEMF U	O	Step detect comparater (U) output terminal
59	BEMF V	O	Step detect comparater (V) output terminal
60	BEMF W	O	Step detect comparater (W) output terminal
61	SL COM	I	Step motor coil center input terminal
62	SL VM1	I	Power supply terminal
63	NC	—	Not used, open
64	SL U OUT	I	Stepping motor (U) input terminal
65	SL PG1	—	GND terminal
66	NC	—	Not used, open
67	SL V OUT	I	Stepping motor (V) input terminal
68	NC	—	Not used, open
69	SL VM2	I	Power supply terminal
70	SL W OUT	O	Stepping motor (W) output terminal
71	SL PG2	—	GND terminal
72	NC	—	Not used, open
73	PW1VM	I	Power supply terminal
74	NC	—	Not used, open
75	PW1 OUT	O	Half bridge 1 output terminal
76	NC	—	Not used, open
77	PW PG	—	GND terminal
78	NC	—	Not used, open
79	PW2 OUT	O	Half bridge 2 output terminal
80	PW2 VM	I	Power supply terminal

Pin No.	Mark	I/O Division	Function
17	MMOD	—	Memory mode select input terminal (Connected to GND)
18	REM DATA	O	LCD driver data output terminal
19	RXD	I	Connected to GND through capacitor
20	NC	O	Not used
21	SSDW	O	MSP/MDA interface writing data output terminal
22	SSDR	I	MSP/MDA interface reading data input terminal
23	SSCLK	O	MSP/MDA interface data forward clock output terminal
24	BUZZER	O	Buzzer output terminal
25	RST	I	Reset signal input terminal
26	SELAD	O	MSP/MDA interface address signal output terminal
27	NC	—	Not used, open
28	LCD STB	O	LCD driver strobe signal output terminal
29	REC SENSE	O	REC sensitivity-select output terminal
30	MONO/ST	O	REC amp monaural/stereo select terminal
31	WAKEUP	I	Micro computer wake up signal input terminal
32	MDISY	I	Leader synchronize signal from IC101 input terminal
33	SCTSY	I	ADIP/sub A synchronize signal from IC101 input terminal
34	CFSYNC	I	MDA synchronize signal from IC101 input terminal (11.6ms pulse)
35	OPENSW	I	Disc cover open/close switch det. input terminal ("H":open, "L":close)
36	LCD DATA	O	LCD driver data output terminal
37	—	—	Connected to GND
38	LCD CK	I	LCD driver clock input terminal
39	NC	—	Not used, open
~41			
42	CHARGE1	O	Recharging control output terminal
43	NRECP	O	Track jump det. output terminal
44	EEPCS	O	EEPROM chip select output terminal
45	EEPCK	O	EEPROM clock output terminal
46	EEPDATA0	O	EEPROM data output terminal
47	EEPDATAI	I	EEPROM data input terminal
48	PLAY KEY	I	PLAY/PAUSE KEY input terminal
49	REC KEY	I	REC/PAUSE KEY input terminal
50	DC IN WAKEUP	I	DC IN wake up input terminal
51	REG	I	Area selection input terminal
52	MHEAD UP	I	Magnetic head down input terminal
53	PROTECT	I	Erase prevention switch input terminal
54	JITTER OK	I	Connected to power supply through resistor
55	HOLD SW	I	HOLD switch input terminal ("H":OFF, "L":ON)
56	DCINDET	I	DC IN det. input terminal
57	MIC DET	I	Mic det. input terminal
58	INSEL	I	INPUT select det. input terminal
59	JOGA	I	JOG pulse A input terminal
60	JOGB	I	JOG pulse B input terminal
61	MIC/LINE	O	MIC/LINE select output terminal
62	LOAD0	O	Magnetic head movement control 0 output terminal
63	LOAD1	O	Magnetic head movement control 1 output terminal
64	HFON1	I	HF module ON 1 input terminal
65	MUTEA	O	Analog mute A output terminal
66	MUTEB	O	Analog mute B output terminal
67	NRFSTBY	O	RF amp standby output terminal

15.4. IC501 (MN101CF32GCA) : SYSTEM CONTROL

Pin No.	Mark	I/O Division	Function
1	VREF-	I	Reference voltage input terminal
2	REM KEY	I	Remote cont. key input terminal
3	KEY IN1	I	Unit key1 input terminal
4	KEY IN2	I	Unit key2 input terminal
5	BATT1	I	Battery voltage det. input terminal
6	AN4	—	Connected to reference voltage
7	TEMP	I	Temperature sensor input terminal
8	DOCTOR	I	Doctor mode input terminal
9	AN7	—	Connected to power supply
10	VREF+	I	Reference voltage input terminal
11	VDD	I	Power supply terminal
12	OSC2	I	System clock input terminal (f=10.02MHz)
13	OSC1	O	System clock output terminal (f=10.02MHz)
14	VSS	—	GND terminal
15	XI	I	Sub clock input terminal (Not used, connected to GND)
16	XO	O	Sub clock output terminal (Not used, open)

Pin No.	Mark	I/O Division	Function
68	ADC OFF	O	ADC OFF output terminal
69	LOW BST	O	VMS select output terminal
70	DEO	O	DE emphasis output terminal
71	DAC OFF	O	DAC off output terminal
72	RECCNT2	O	REC control 2 output terminal
73	RFCNT	O	RF power supply control output terminal
74	RECCNT1	O	REC control 1 output terminal

Pin No.	Mark	I/O Division	Function
75	PWRCNT	O	Power supply control output terminal
76	EL ON	I	EL display control input terminal
77	PC	O	4ch driver standby output terminal
78	STBY2	O	FD/TR coil power supply control output terminal
79	NC	—	Not used, open
80	MSP RST	O	MSP reset output terminal

16 Caution in Use of Rechargeable Battery Ass'y

- Take Rechargeable Battery Ass'y out of Battery Carrying Case and use it.
- Be sure to carry Rechargeable Battery Carrying Case. If not, it may either heat or ignite by shorting with a metal. (as shown in Fig.9)

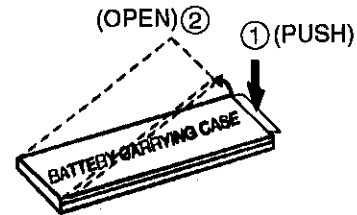

Fig.9

17 Supply of Rechargeable Battery Ass'y as Replacement Parts

Please take note of the following points relating to Battery Carrying Case to be used for protection of Rechargeable Battery Ass'y from shorting. Replacement Parts:

- Rechargeable Battery Ass'y (RFKFBP140HSY) supplied will be provided with Battery Carrying Case (RFA0475-Q).
- No replacement parts will be supplied for Rechargeable Battery Ass'y without Battery Carrying Case.
- Replacement parts will be supplied for Battery Carrying Case (RFA0475-Q) without Rechargeable Battery Ass'y.
- To your customers, delivery Rechargeable Battery Ass'y together with Battery Carrying Case to prevent shorting accidents that may occur when Rechargeable Battery Ass'y is carried about Battery Carrying Case. (as shown in Fig.8)

Rechargeable Battery Case (RFA0475-Q)

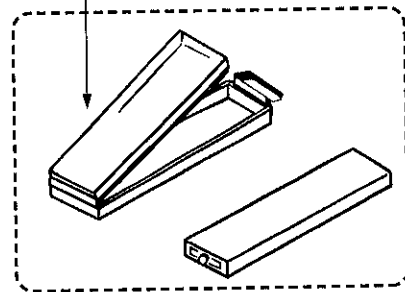

Rechargeable Battery with Carrying Case (RFKFBP140HSY)

Fig.8

18 Resolution Procedure and Parts Format of Remote Controller's Clip Unit

- Remove two screws with precision driver.

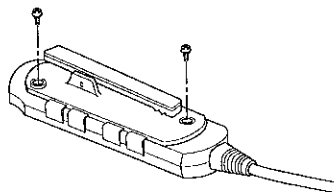

- Lift up the clip and remove the clip unit.

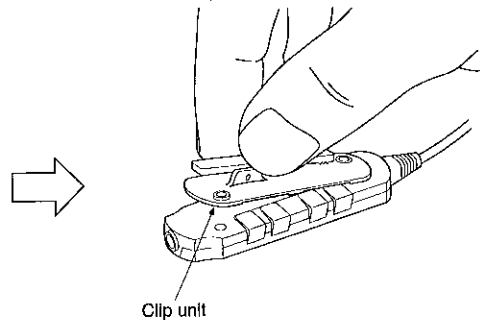

Note)

As removed screws are not supplied as replacement parts, be careful not to lose it.

19 Replacement Parts List

Notes:

*Important safety notice:

Components identified by Δ mark have special characteristics important for safety.

Furthermore, special parts which have purposes of fire-retardant (resistors), high-quality sound (capacitors), low-noise (resistors), etc. are used.

When replacing any of components, be sure to use only manufacture's specified parts shown in the parts list.

*Warning: This product uses a laser diode. Refer to caution statements.

*ACHTUNG:Die lasereinheit nicht zerlegen.Die lasereinheit darf nur gegen einc vom hersteller spezifizierte einheit ausgetauscht werden.

*Capacity values are in microfarads (μ F) unless specified otherwise, P=Pico-farads (pF) F=Farads (F)

*Resistance values are in ohms, unless specified otherwise, 1K=1,000 (OHM), 1M=1,000K (OHM)

*The marking <RTL> indicates that the Retention Time is limited for this item. After the discontinuation of this assembly in production, the item will continue to be available for a specific period of time. The retention period of availability is dependant on the type of assembly , and in accordance with the laws governing part and product retention. After the end of this period, the assembly will no longer be available.

***<IA> " <IB>" marks in Remarks indicate languages of instruction manuals.

[<IA>:English/Spanish/French/German/Netherlands/Swedish/Italian/Danish, <IB>:English/Chinese]

Ref. No.	Part No.	Part Name & Description	Pcs	Remarks
1	RXM0070-3	LINK UNIT	1	
1-1	RMB0622	SPRING	1	
2	RGK1158-S	INTERMEDIATE ORNAMENT	1	
3	RGU1769-S	BUTTON OPERATION	1	
4	RGV0250-R1	REC KNOB	1	
5	RHE5155YA	SCREW	9	
6	RHQ0083-S	SCREW	6	
7	RJB2104A	FPC	1	
8	RMN0536-1	LCD HOLDER	1	
9	RMZ0492	SHEET	1	
10	RMZ0505	LCD SPACER (C)	1	
11	RMZ0506	LCD SPACER (D)	1	
13	RYF0518-S	DISC COVER ASS'Y	1	
14	RYK0936A-S	CABINET ASS'Y	1	(EB,EG)
14	RYK0936B-S	CABINET ASS'Y	1	(GH)
15	RGK1157-S	INTERMEDIATE CABI. ASS'Y	1	
15-1	RGV0248-S	HOLD KNOB	1	
15-2	RGV0249-S	OPEN KNOB	1	
16	RHD14076-S	SCREW	6	
17	RKK0129-S1	BATTERY COVER	1	
18	RAE1620Z	MD MECHANISM UNIT	1	
Δ				
18-1	RDG0446	INTERMEDIATE GEAR	1	
18-2	RHD14067	SCREW	1	
18-3	RHW11011	WASHER	1	
18-4	RMC0379	SPRING	1	
18-5	RMA1219-3	HOLDER	1	
18-6	RMB0546	EJECT SPRING	1	
18-7	RML0550	LIFTER	1	
18-8	RMM0215-2	CONNECTION ROD	1	

Ref. No.	Part No.	Part Name & Description	Pcs	Remarks
18-9	RMM0216	EJECT ROD	1	
18-10	RDG0450	MOTOR GEAR	1	
18-11	HPX13NA1C	SPINDLE MOTOR	1	
18-12	RDG0451	RELAY GEAR	1	
18-13	RDG0452-1	DRIVE GEAR	1	
18-14	RDG0453-1	DOWN GEAR	1	
18-15	BQL1A1CWF	TRAVERSE MOTOR	1	
18-17	RHD14072	SCREW	3	
18-18	RHD14073	SCREW	1	
18-19	XQN14+C18FN	SCREW	1	
18-20	RHW09001	WASHER	1	
18-21	RMG0525-K	STOPPER RUBBER	1	
18-22	RMC0381	MOTOR SPRING	1	
18-23	RMM0217	DRIVE ROD	1	
18-24	RMX0147	STOPPER RUBBER	3	
18-25	RJB2075A	SWITCH FPC	1	
18-26	XQN14+C12FZ	SCREW	1	
18-27	RHD12001	SCREW	2	
18-28	REM0082	LIFT MOTOR UNIT	1	
18-29	RMB0635-1	SPRING	1	
18-30	RMX0159	SHEET	1	
18-31	RMZ0510	SHEET	1	
19	RHD14057-K	SCREW	1	
20	RHD14073	SCREW	1	
21	RHD14075	SCREW	4	
23	RJB2105A	FPC	1	
24	RJC99033-1	R. BATTERY TERMINAL (+)	1	
25	RJR0183	BATTERY SHAFT	1	
26	RMG0515-A	FLOATING RUBBER	4	
27	RMN0537	BATTERY HOLDER	1	
28	RHQ0083-S	SCREW	2	
29	RMA1244-1	CHASSIS	1	
30	RXQ0638-1	LOCK UNIT	1	
31	RXQ0639	R. BATTERY TERMINAL (-)	1	
33	RMQ0916	TAPE	1	
34	RMF0274	SHEET	1	
35	RMG0526-K	SHEET	1	
A1	RFKFBP140HSY	RECHARGE. BATTERY ASS'Y	1	
A1-1	RFA0475-Q	RECHARGEABLE BATTERY CASE	1	
A2	RFA1320-S	BATTERY CASE	1	
A3	RFC0056-K	CARRYING CASE	1	
Δ	RFEA003B-S	AC ADAPTOR	1	(EB)
Δ	RFEA002E-S	AC ADAPTOR	1	(EG)
Δ	RFEA004H-S	AC ADAPTOR	1	(GH)
A5	RFEV023P-SM	WIRED REMOTE CONTROL	1	
A5-1	RYQ0287-H	CLIP	1	
A6	RFEV319P-SA	STEREO EARPHONES	1	
A7	RJL2P007X08	LINE CABLE	1	
A8	RQT5119-B	INSTRUCTION MANUAL	1	(EB EG) <IA>
A8	RQT5121-G	INSTRUCTION MANUAL	1	(GH) <IB>
A9	RQA0117	WARRANTY CARD	1	
A10	RQCB0169	SERVICENTER LIST	1	
C1	ECUE1H221KBQ	50V 220P	1	
C2,3	ECUVNA224KBV	10V 0.22U	1	
C4	ECUE1C153KBQ	16V 0.015U	1	
C5,6	RCSTOGZ106RG	4V 10U	1	
C7	ECUENA104KBQ	10V 0.1U	1	
C8	ECUE1C153KBQ	16V 0.015U	1	
C10	ECUE1H181KBQ	50V 180P	1	
C11	ECUVNA105KBN	10V 1U	1	

Ref. No.	Part No.	Part Name & Description	Pcs	Remarks
C12	ECUENA104KBQ	10V 0.1U	1	
C13	RCST0GZ106RG	4V 10U	1	
C14	ECUVNA224KBV	10V 0.22U	1	
C15	ECUVNJ105KBV	63V 1U	1	
C16	ECUE1H181KBQ	50V 180P	1	
C17	ECUE1C223KBQ	16V 0.022U	1	
C18	ECUE1H101KBQ	50V 100P	1	
C19-21	ECUE1H102KBQ	50V 1000P	3	
C22	ECUE1E682KBQ	25V 6800P	1	
C23	ECUENA393KBQ	10V 0.039U	1	
C24	ECUE1E332KBQ	25V 3300P	1	
C27	ECUENA104KBQ	10V 0.1U	1	
C28	ECUE1E332KBQ	25V 3300P	1	
C29-32	ECUE1H102KBQ	50V 1000P	4	
C33	ECUVNA224KBV	10V 0.22U	1	
C34	ECUE1C103KBQ	16V 0.01U	1	
C35	ECUE1C123KBQ	16V 0.012U	1	
C36,37	ECUV1C823KBV	16V 0.082U	2	
C38	ECUENA104KBQ	10V 0.1U	1	
C39	RCST0GZ226RG	4V 22U	1	
C40	ECUE1H102KBQ	50V 1000P	1	
C41	ECUE1C183KBQ	16V 0.018U	1	
C42	ECUV0J474KBV	6.3V 0.47U	1	
C43	ECUVNJ105KBV	63V 1U	1	
C44	ECUE1E332KBQ	25V 3300P	1	
C101	RCST0GZ106RG	4V 10U	1	
C102,03	ECUENA104KBQ	10V 0.1U	2	
C104	ECUE1H102KBQ	50V 1000P	1	
C105	ECUE1C103KBQ	16V 0.01U	1	
C106	ECUENA104KBQ	10V 0.1U	1	
C107	RCST0GZ106RG	4V 10U	1	
C108	ECUENA104KBQ	10V 0.1U	1	
C109	RCST0GZ106RG	4V 10U	1	
C110,11	ECUENA104KBQ	10V 0.1U	2	
C112,13	ECUE1H120JQC	50V 12P	2	
C114	ECUENA104KBQ	10V 0.1U	1	
C115	ECUE1C123KBQ	16V 0.012U	1	
C116	ECUE1H221KBQ	50V 220P	1	
C117	ECUENA473KBQ	10V 0.047U	1	
C118	ECUENA104KBQ	10V 0.1U	1	
C120	ECUENA104KBQ	10V 0.1U	1	
C201	ECUENA104KBQ	10V 0.1U	1	
C202	RCST0GZ106RG	4V 10U	1	
C203	ECUVNJ105KBV	63V 1U	1	
C204	RCST0GZ475RG	4V 4.7U	1	
C205	RCST0GZ106RG	4V 10U	1	
C206	ECUVNJ274KBV	6.3V 0.27U	1	
C207	RCST0GZ475RG	4V 4.7U	1	
C208	ECUVNJ274KBV	6.3V 0.27U	1	
C209	ECUENA104KBQ	10V 0.1U	1	
C210	RCST0GZ106RG	4V 10U	1	
C211-13	ECUENA104KBQ	10V 0.1U	3	
C214,15	RCST0EX227RE	2.5V 220U	2	
C216,17	ECUVNA224KBV	10V 0.22U	2	
C218	ECUE1H101KBQ	50V 100P	1	
C219,20	ECUE1H102KBQ	50V 1000P	2	
C301	EEFCD0J470R	6.3V 47U	1	
C302	ECUE1C103KBQ	16V 0.01U	1	
C303	EEFCD0J470R	6.3V 47U	1	
C304	ECUE1E332KBQ	25V 3300P	1	
C305	RCST0JY156RG	6.3V 15U	1	
C306	ECUENA104KBQ	10V 0.1U	1	
C307	EEVMC0G221P	4V 220U	1	
C308-10	ECUENA104KBQ	10V 0.1U	3	
C311	RCST0GZ226RG	4V 22U	1	
C312,13	ECUE1C103KBQ	16V 0.01U	2	
C401	RCST0GZ106RG	4V 10U	1	
C402	ECUENA104KBQ	10V 0.1U	1	
C403,04	ECUE1H102KBQ	50V 1000P	2	
C407	RCST0GZ106RG	4V 10U	1	
C408-11	ECUENA104KBQ	10V 0.1U	4	
C412,13	ECUE1H221KBQ	50V 220P	2	
C414	RCST0GZ226RG	4V 22U	1	

Ref. No.	Part No.	Part Name & Description	Pcs	Remarks
C415	ECUVNJ105KBV	63V 1U	1	
C416-18	ECUE1H222KBQ	50V 2200P	3	
C419-21	ECUVNA105KBN	10V 1U	3	
C423	RCST0GR476RE	4V 47U	1	
C424	ECUVNA105KBN	10V 1U	1	
C425,26	ECUENC273KBQ	16V 0.027U	2	
C427	ECUVNA224KBV	10V 0.22U	1	
C429-31	ECUENC333KBQ	16V 0.033U	3	
C501,02	ECUE1H101KBQ	50V 100P	2	
C503	ECUE1C103KBQ	16V 0.01U	1	
C504	ECUE1H102KBQ	50V 1000P	1	
C505	RCST0GZ106RG	4V 10U	1	
C506	ECUENA104KBQ	10V 0.1U	1	
C507	ECUE1C103KBQ	16V 0.01U	1	
C508	ECUV0J474KBV	6.3V 0.47U	1	
C509	ECUE1C103KBQ	16V 0.01U	1	
C510	ECUENA104KBQ	10V 0.1U	1	
C511,12	ECUE1H102KBQ	50V 1000P	2	
C513	ECUENA104KBQ	10V 0.1U	1	
C601	RCST0GZ475RG	4V 4.7U	1	
C602,03	ECUENA104KBQ	10V 0.1U	2	
C604	RCST0GZ475RG	4V 4.7U	1	
C605	RCST0GZ226RG	4V 22U	1	
C606,07	ECUE1H222KBQ	50V 2200P	2	
C608	RCST0GZ226RG	4V 22U	1	
C609	ECUENA104KBQ	10V 0.1U	1	
C610	RCST0GZ475RG	4V 4.7U	1	
C611	ECUENA104KBQ	10V 0.1U	1	
C612	RCST0GZ226RG	4V 22U	1	
C613	ECUENA104KBQ	10V 0.1U	1	
C614,15	ECUVNA105KBN	10V 1U	2	
C701	ECUENA104KBQ	10V 0.1U	1	
C702,03	ECUE1C103KBQ	16V 0.01U	2	
C704	ECUVNA224KBV	10V 0.22U	1	
C705	RCST0GZ106RG	4V 10U	1	
C706	ECUVNA224KBV	10V 0.22U	1	
C707	RCST0GZ106RG	4V 10U	1	
C708-12	ECUVNJ335KBN	63V 3.3U	5	
C713	RCST0GZ106RG	4V 10U	1	
C714	RCST0GZ475RG	4V 4.7U	1	
C715	RCST0GZ226RG	4V 22U	1	
C716	ECUENA104KBQ	10V 0.1U	1	
C717	RCST0GZ225RG	4V 2.2U	1	
C718	RCST0GZ106RG	4V 10U	1	
C719	ECUE1H471KBQ	16V 470P	1	
C801	ECUENC333KBQ	16V 0.033U	1	
C802	ECUE1H101KBQ	50V 100P	1	
C803	ECUE1C103KBQ	16V 0.01U	1	
C901	RCST0GZ106RG	4V 10U	1	
C902	ECUVNC104KBV	16V 0.1U	1	
C903	ECUV1E473KBN	25V 0.047U	1	
C904	ECUVNC104KBV	16V 0.1U	1	
C905	ECUV1H150KCV	50V 15P	1	
CN1	RJS2A7126T	CONNECTOR (26P)	1	
CN401	RJS2A7104T	CONNECTOR (4P)	1	
CN402	RJS2A7108T	CONNECTOR (8P)	1	
CN403	RJS2A7106T	CONNECTOR (6P)	1	
CN404	RJS2A7104T	CONNECTOR (4P)	1	
CN701	RJS2A7111T	CONNECTOR (11P)	1	
CN901	RJS2A7108T	CONNECTOR (8P)	1	
CN902	RJS2A7104T	CONNECTOR (4P)	1	
CP801	RJS2A7411T	CONNECTOR (11P)	1	
CP802	RJS2A7107T	CONNECTOR (7P)	1	
CX315,16	RCST0GZ226RG	4V 22U	2	
CX405	ECUE1H101KBQ	50V 100P	1	
D1	MA2S111TX	DIODE	1	
D301	MA133TX	DIODE	1	
D303,04	F1J2ETP	DIODE	2	
D305	RB491DT146	DIODE	1	

Ref. No.	Part No.	Part Name & Description	Pcs	Remarks
D311	MA2S111TX	DIODE	1	
D501,02	MA741WATX	DIODE	2	
D901,02	ZHCS1006TA	DIODE	2	
IC1	AN8772FHKEBV	IC	1	
IC101	MN66616RB1	IC	1	
IC102	MNA7400CWA1T	IC	1	
IC201	TA2131FL	IC	1	
IC301	NJU7015RFE1	IC	1	
IC302	XC6368A261MR	IC	1	
IC303	XC6367A151MR	IC	1	
IC304	XC6372C501PR	IC	1	
IC402	BD6604KVT	IC	1	
IC501	MN101CF32GCA	IC	1	
IC502	AK93C45BH-L	IC	1	
IC503	XC61FC2012MR	IC	1	
IC601	AK4518VF-E2	IC	1	
IC701	AN7635SH-E1	IC	1	
IC901	TC74ACT04FSE	IC	1	
JK702	RJJ34R01-H	JACK MIC	1	
L1	RLQP100MT-W	COIL	1	
L101	RLQP100MT-W	COIL	1	
L103,04	RLQP100MT-W	COIL	2	
L201,02	RLBV601V-W	COIL	2	
L203	RLQP100MT-W	COIL	1	
L301	RLZ0041T-T	COIL	1	
L302	RLZ0040T-T	COIL	1	
L303	ELJEA470KF	COIL	1	
L304	RLQP100MT-W	COIL	1	
L305	RLM9Z006T-D	COIL	1	
L402-06	RLQP100MT-W	COIL	5	
L407	ELJEA470KF	COIL	1	
L501	RLQP100MT-W	COIL	1	
L701-03	RLBV601V-W	COIL	3	
L705,06	RLBV601V-W	COIL	2	
L707	RLQP100MT-W	COIL	1	
L901	ELJEA100KF	COIL	1	
LCD801	RSL5239-C	LCD	1	
P1	RPK1292	PACKING CASE	1	
P2	RPQ0991	PAD	1	
P3	RPF0257-1	PROTECTION BAG	1	
PCB1	REP2837A-S	OPERATION P.C.B.	1	<RTL>
PCB2	REP2808A	SWITCH P.C.B.	1	<RTL>
PCB3	REP2828A-M	HEAD P.C.B.	1	<RTL>
PCB4	REP2836B-M	MAIN P.C.B.	1	<RTL>
Q1	2SB1295-6-TB	TRANSISTOR	1	
Q2	2SB1462STX	TRANSISTOR	1	
Q3	DTC144TETL	TRANSISTOR	1	
Q201	DTC144EETL	TRANSISTOR	1	
Q202	2SB1295-6-TB	TRANSISTOR	1	
Q203	2SD2216STX	TRANSISTOR	1	
Q301	2SD2216STX	TRANSISTOR	1	
Q302	XP151A12A2MR	TRANSISTOR	1	
Q303	XP4601TX	TRANSISTOR	1	
Q304	XP161A1355PR	TRANSISTOR	1	
Q305	XP152A12COMR	TRANSISTOR	1	
Q306,07	XP161A1355PR	TRANSISTOR	2	
Q308	2SB1462STX	TRANSISTOR	1	
Q309	XP151A12A2MR	TRANSISTOR	1	
Q310	DTC144TETL	TRANSISTOR	1	
Q312	XP152A12COMR	TRANSISTOR	1	
Q405-08	XP151A12A2MR	TRANSISTOR	4	
Q409	UMG6NTR	TRANSISTOR	1	
Q701	2SD2216STX	TRANSISTOR	1	
Q702	2SB1462STX	TRANSISTOR	1	

Ref. No.	Part No.	Part Name & Description	Pcs	Remarks
Q703	UMG2NTR	TRANSISTOR	1	
Q704	XP152A12COMR	TRANSISTOR	1	
Q705	2SD2216STX	TRANSISTOR	1	
Q901-04	2SK1764KYTR	TRANSISTOR	4	
R1	ERJ2GEJ472X	1/4W 4.7K	1	
R2	ERJ2GEJ222X	1/4W 2.2K	1	
R5	ERJ2GEJ103X	1/4W 10K	1	
R10	ERJ2GEJ103X	1/4W 10K	1	
R11,12	ERJ2GEJ103X	1/4W 10K	2	
R13	ERJ2GEOR00X	1/4W 0	1	
R14	ERJ2GEJ471X	1/4W 470	1	
R15	ERJ2GEJ473X	1/4W 47K	1	
R16	ERJ2GEJ472X	1/4W 4.7K	1	
R18	ERJ2GEJ474X	1/4W 470K	1	
R19,20	ERJ2GEJ104X	1/4W 100K	2	
R21	ERJ2GEJ223X	1/4W 22K	1	
R22	ERJ2GEJ102X	1/4W 1K	1	
R23	ERJ2GEJ473X	1/4W 47K	1	
R24,25	ERJ2GEJ272X	1/4W 2.7K	2	
R28	ERJ2GEJ473X	1/4W 47K	1	
R29	ERJ2GEJ333X	1/4W 33K	1	
R30	ERJ2GEJ473X	1/4W 47K	1	
R31	ERJ2GEOR00X	1/4W 0	1	
R32,33	ERJ2GEJ473X	1/4W 47K	2	
R34	ERJ2GEJ223X	1/4W 22K	1	
R35	ERJ2GEJ473X	1/4W 47K	1	
R102	ERJ2GEOR00X	1/4W 0	1	
R107	ERJ2GEJ105X	1/4W 1M	1	
R108	ERJ2GEJ223X	1/4W 22K	1	
R110	ERJ2GEJ683X	1/4W 68K	1	
R111	ERJ2GEJ682X	1/4W 6.8K	1	
R113	ERJ2GEJ102X	1/4W 1K	1	
R114	ERJ2GEJ473X	1/4W 47K	1	
R201	ERJ2GEJ104X	1/4W 100K	1	
R202	ERJ2GEJ221X	1/4W 220	1	
R203	ERJ2GEJ102X	1/4W 1K	1	
R204	EXB24V225JX	1/16W 2.2M	1	
R205	ERJ2GEJ223X	1/4W 22K	1	
R206	EXB24V100JX	1/16W 10	1	
R207	ERJ2GEJ471X	1/4W 470	1	
R208	ERJ3GEYD273V	1/16W 27K	1	
R209	EXB28V103JX	1/32W 10K	1	
R211	EXB24V332JX	1/16W 3.3K	1	
R301	EXB24V334JX	1/16W 330K	1	
R302	ERJ2GEJ104X	1/4W 100K	1	
R303	ERJ2GED333X	1/4W 33K	1	
R304	ERJ2GEJ103X	1/4W 10K	1	
R306	ERJ2GEJ103X	1/4W 10K	1	
R307	ERJ2GEJ104X	1/4W 100K	1	
R308	ERJ2GEJ474X	1/4W 470K	1	
R309	ERJ2GEJ394X	1/4W 390K	1	
R310,11	ERJ2GED513X	1/4W 51K	2	
R312	ERJ2GED105X	1/4W 1M	1	
R313	EXB24V104JX	1/4W 100K	1	
R314	ERJ2GEJ154X	1/4W 150K	1	
R315	ERJ2GED104X	1/4W 100K	1	
R316	ERJ2GEJ104X	1/4W 100K	1	
R317	ERJ6RSJR10V	1/10W 0.1	1	
R318	ERJ2GED105X	1/4W 1M	1	
R319,20	ERJ2GEJ474X	1/4W 470K	2	
R321	ERJ2GEJ394X	1/4W 390K	1	
R322	ERJ2GEJ225X	1/4W 2.2M	1	
R323	ERJ2GED105X	1/4W 1M	1	
R324,25	ERJ2GEJ474X	1/4W 470K	2	
R326	ERJ2GEOR00X	1/4W 0	1	
R401	EXB24V474JX	1/16W 470K	1	
R402	ERJ2GEJ103X	1/4W 10K	1	
R405	ERJ2GEJ103X	1/4W 10K	1	
R406,07	ERJ2GEJ473X	1/4W 47K	2	
R408	ERJ2GEJ103X	1/4W 10K	1	
R501	ERJ2GEJ473X	1/4W 47K	1	
R502	ERJ2GEJ103X	1/4W 10K	1	

Ref. No.	Part No.	Part Name & Description	Pcs	Remarks
R504	EXB28V334JX	1/32W 330K	1	
R505	ERJ2GEJ104X	1/4W 100K	1	
R506	EXB24V103JX	1/4W 10K	1	
R507	EXB28V224JX	1/32W 220K	1	
R508	EXB28V103JX	1/32W 10K	1	
R509	ERJ2GEJ223X	1/4W 22K	1	
R510	EXB24V104JX	1/4W 100K	1	
R511	ERJ2GEJ103X	1/4W 10K	1	
R512	ERJ2GEOR00X	1/4W 0	1	
R513	EXB28V334JX	1/32W 330K	1	
R514	ERJ2GEJ334X	1/4W 330K	1	
R515	EXB24V224JX	1/4W 220K	1	
R516	EXB24V221JX	1/4W 220	1	
R601	EXB24V102JX	1/4W 1K	1	
R602	ERJ2GEJ220X	1/4W 22	1	
R603	EXB24V123JX	1/4W 12K	1	
R604	ERJ2GEJ332X	1/4W 3.3K	1	
R605	ERJ2GEJ5R6X	1/4W 5.6	1	
R606	ERJ2GEJ332X	1/4W 3.3K	1	
R607	EXB24V222JX	1/4W 2.2K	1	
R701	ERJ2GEJ102X	1/4W 1K	1	
R702	ERJ2GEJ103X	1/4W 10K	1	
R703	EXB24V104JX	1/4W 100K	1	
R704	EXB24V333JX	1/4W 33K	1	
R705	EXB24V102JX	1/4W 1K	1	
R706	EXB24V471JX	1/4W 470	1	
R707	ERJ2GEJ394X	1/4W 390K	1	
R708	ERJ2GEJ104X	1/4W 100K	1	
R709	ERJ2GEJ473X	1/4W 47K	1	
R710	ERJ2GEJ474X	1/4W 470K	1	
R711	ERJ2GEJ104X	1/4W 100K	1	
R712	ERJ2GEJ473X	1/4W 47K	1	
R713	ERJ2GEJ101X	1/4W 100	1	

Ref. No.	Part No.	Part Name & Description	Pcs	Remarks
R714	ERJ2GEJ473X	1/4W 47K	1	
R715	ERJ3GEYJ335V	1/16W 3.3M	1	
R801	ERJ3GEYJ332V	1/16W 3.3K	1	
R802	ERJ3GEYJ682V	1/16W 6.8K	1	
R803	ERJ3GEYJ223V	1/16W 22K	1	
R804	ERJ3GEYJ332V	1/16W 3.3K	1	
R805	ERJ3GEYJ682V	1/16W 6.8K	1	
R806	ERJ3GEYJ223V	1/16W 22K	1	
R807,08	ERJ2GEJ473X	1/4W 47K	2	
R909	ERJ6GEYJ6R8V	1/10W 6.8	1	
RX103	ERJ2GEJ104X	1/4W 100K	1	
RX503	ERJ2GEJ334X	1/4W 330K	1	
S501	ABC1112P	SW OPEN DET.	1	
S502	RSS2A010-1A	SW HOLD	1	
S802	RSG0038-P	SW PLAY/REC/PAUSE ETC.	1	
S803	ABC1111P	SW,REC	1	
S804-10	RSG0038-P	SW PUSH	7	
S901	RSP1A015-A	SW M.HEAD UP	1	
S1101	RSH1A036-A	SW PROTECT DET.	1	
TH1	RRSP33J103CW	THERMISTOR	1	
VR1	EVM3WSX80B53	VR. LASER POWER ADJ.	1	
X101	RSXC16M9R01T	QUARTS CRYSTAL	1	
X501	RSXY10MOM02T	OSCILLATOR	1	
Z301	RJH9209-1	BATT.CASE CONNECT.TERMINA	1	
Z801	EVQWRU001	JOG DIAL ENTER	1	

20 Cabinet Parts Location

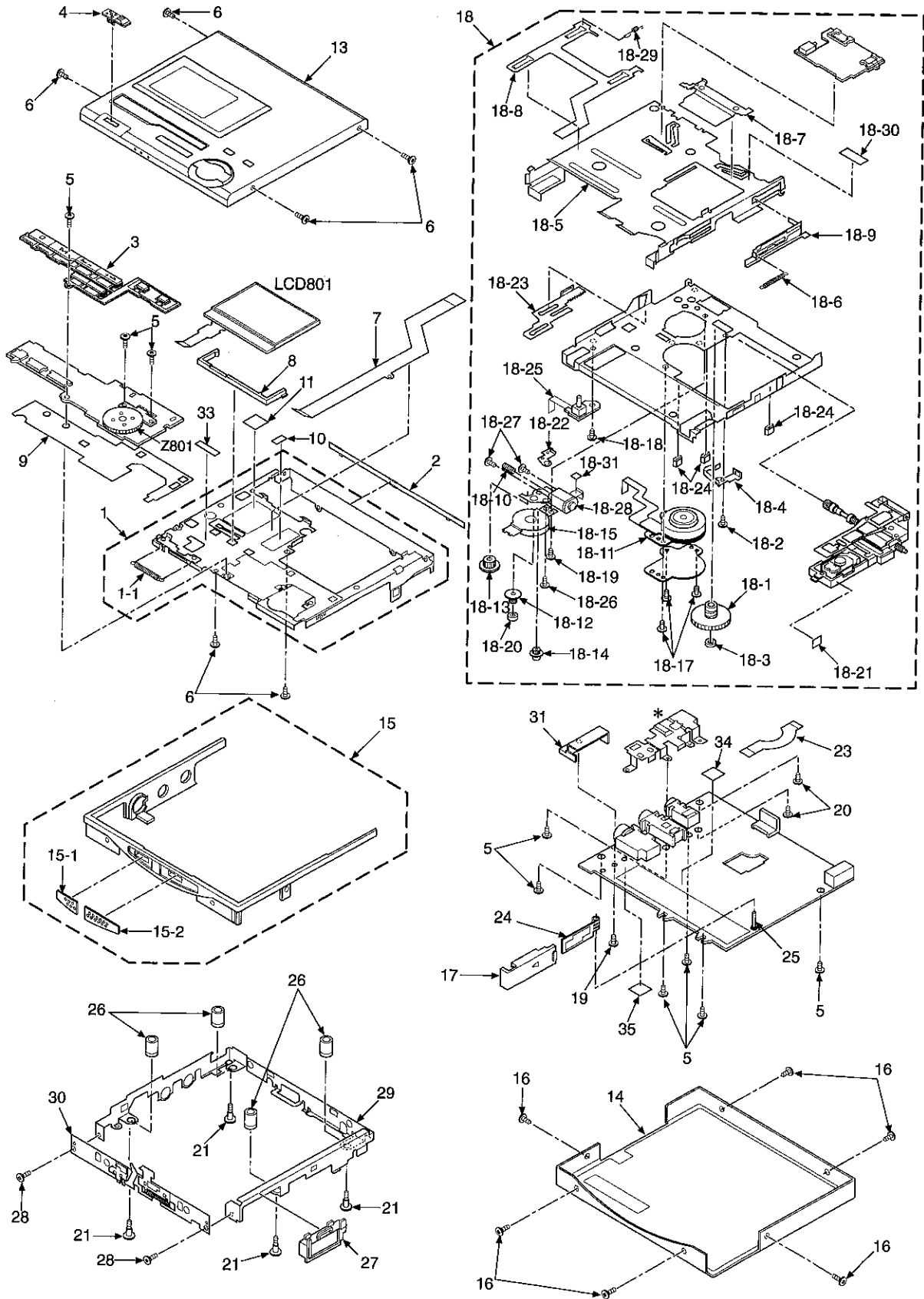

Note : We do not supply those items of parts marked * .

Ref.No	Description
3	<div style="display: flex; align-items: center;"> <div style="width: 15px; height: 15px; background-color: black; margin-right: 5px;"></div> POWER OFF/ <div style="width: 15px; height: 15px; border: 1px solid black; margin: 0 5px;"></div> CHARA/ <div style="width: 15px; height: 15px; border: 1px solid black; margin: 0 5px;"></div> ← - , + →/VOL/CURSOR/DISPLAY, CAPS LOCK/EDIT, MARK MODE/EQ/REC SENS, SPACE/MODE, DELETE </div>

21 Packaging

