

**A** SERVO CIRCUIT (P.C. Board : on page 20)

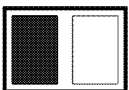

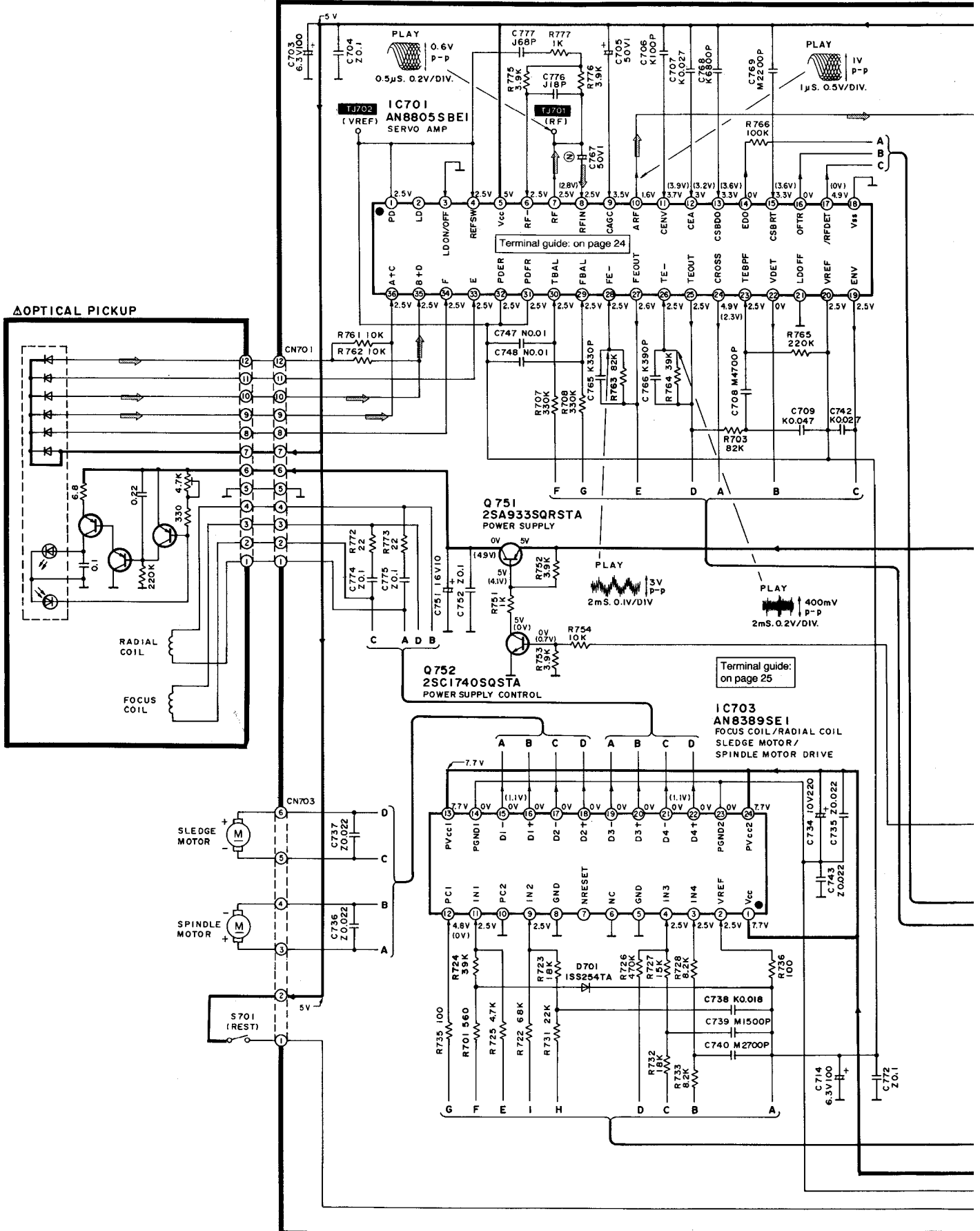

**B** POWER SWITCH CIRCUIT  
(P.C.Board: on page 20)

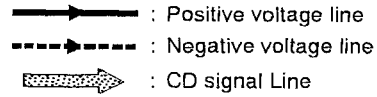
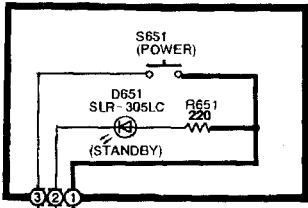

**C** OPERATION CIRCUIT (P.C.Board: on page 21)

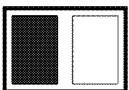
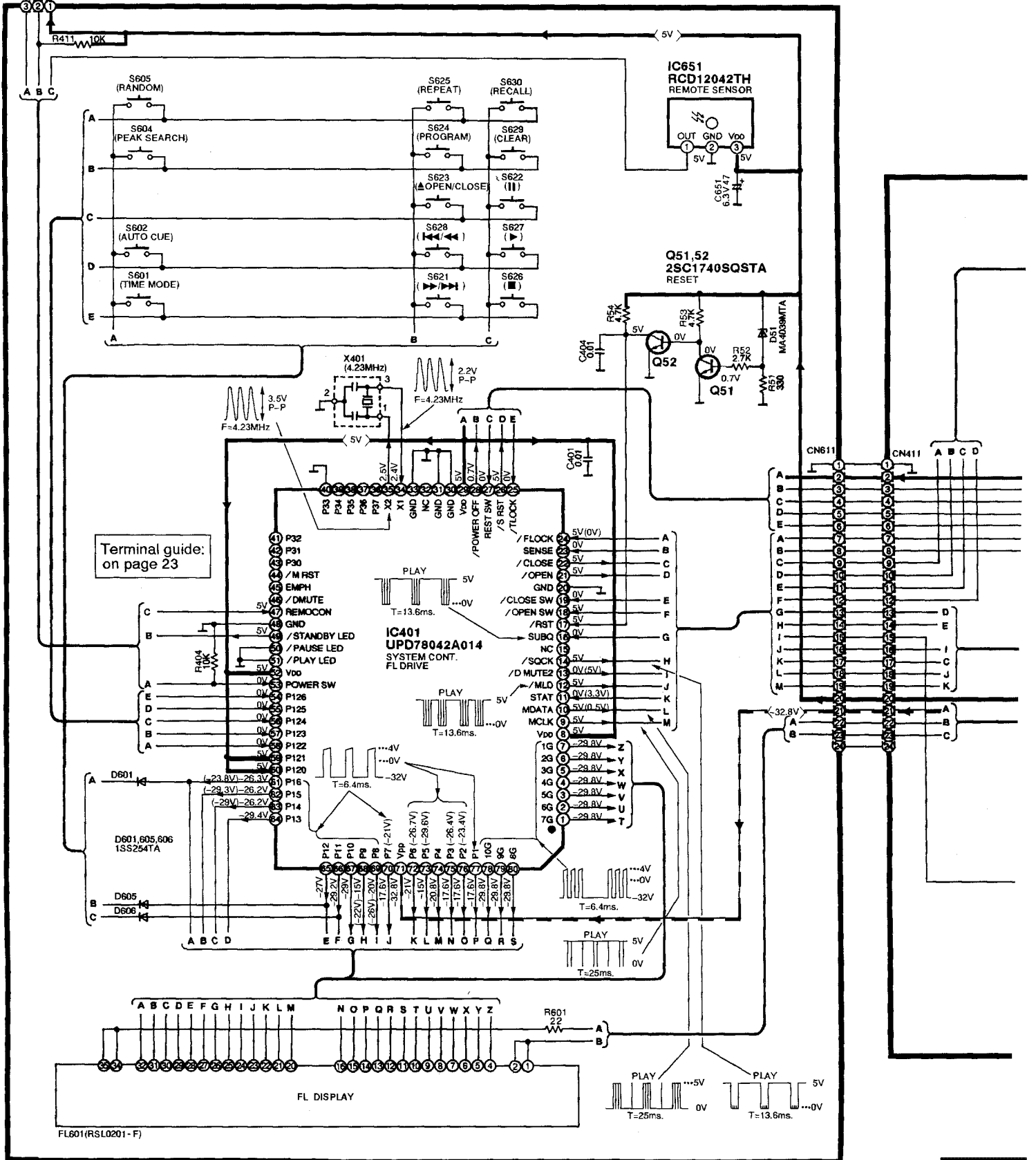

**D** LOADING MOTOR CIRCUIT  
(P.C. Board: on page 20)

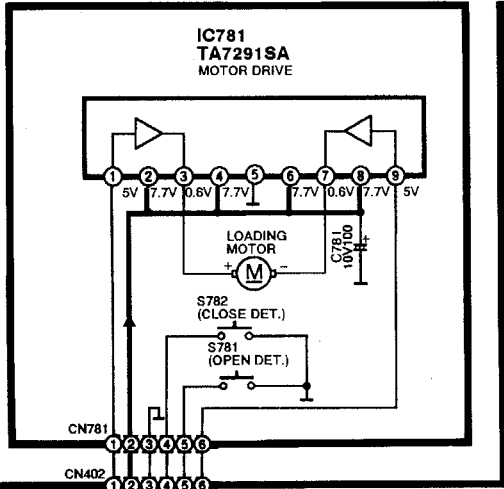

**E** MAIN CIRCUIT (P.C. Board: on page 21)

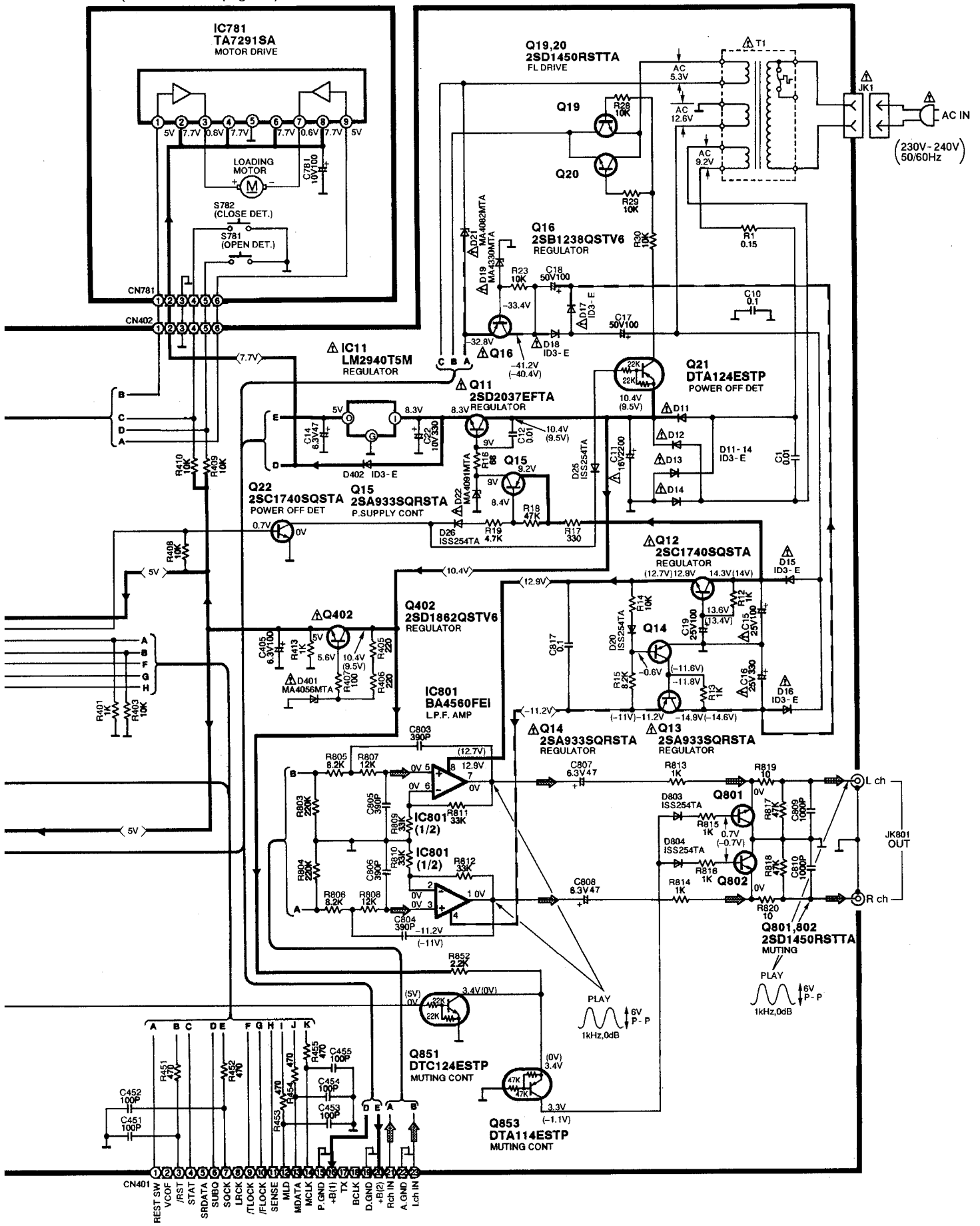

To **A** SERVO CIRCUIT (CN702) on page 17

