

Service Manual

Portable CD Player



MASH*
multi-stage noise shaping

※ • MASH is a trademark of NTT

SL-S650 SL-S651C

Colour (S) ... Silver Type

Areas

- P U.S.A.
- PC Canada.
- EB Great Britain.
- EG Germany.
- GC Asia, Latin America,
Middle East and Africa.
- GN Oceania.

Areas of Every Model

- SL-S650 (P,EB,EG,GC,GN)
- SL-S651C (P,PC)



SL-S650



SL-S651C

Traverse Deck: RAE0142Z Mechanism Series

Specifications

Audio (EXTRA ANTI-SHOCK OFF)

No. of channels:	2 channels (left and right, stereo)
Output voltage:	0.6 V(50 kohm) diameter 3.5 stereo mini jack
Frequency response:	20 ~ 20,000 Hz (+0.5 dB, -1.5 dB)
S/N:	more than 96 dB*
Wow and flutter:	Below measurable limit
DA converter:	1 bit, MASH*
Headphones output level:	max. 9 mW+9 mW/16 ohm (variable) stereo mini jack diameter 3.5
Digital filter:	8 times over sampling

Signal Format

Correction system:	Technics New Super Decoding Algorithm
--------------------	--

Pickup

Type:	One beam
Light source:	Semiconductor laser
Wavelength:	780 nm
Lens:	Glass pressed lens

Playing time

(When used in hold mode, at 25 degree temperature and on flat and stable surface.)

Batteries used: EXTRA ANTI-SHOCK OFF/ON

Panasonic Alkaline dry cell batteries : (LR6, 2pcs.)

SL-S650 (P, EB, EG, GC, GN) : Approx. 20h / 13h

SL-S651C (P, PC) : Approx. 18h / 12h

Rechargeable batteries (Recharging time)

SL-S650 (P) : Approx. 6.5h / 4.5h (3h)

SL-S650 (EB, EG, GC, GN) : Approx. 10.5h / 6.5h (5h)

SL-S651C (P, PC) : Approx. 5h / 3.5h (3h)

Panasonic Alkaline dry cell batteries : (LR6, 4pcs.)

SL-S650 (P, EB, EG, GC, GN) : Approx. 45h / 30h

Rechargeable batteries (Recharging time) + Panasonic Alkaline dry cell batteries (LR6, 2pcs.)

SL-S650 (EB, EG, GC, GN) : Approx. 30h / 20h (5h)

The play time may be less depending on the operating conditions.

General

Operation temperature range: 0—40degree

Rechargeable temperature range: 5—40degree

Power supply: DC 4.5 V

Power consumption(EXTRA ANTI-SHOCK OFF/ON)

AC adaptor:

SL-S650 (P) / SL-S651C (P, PC) : 2.6W/2.8W

SL-S650 (EB, EG, GC, GN) : 2.8W/3.2W

Battery (DC 3V):

SL-S650 (P, EB, EG, GC, GN) : 0.35W/0.4W

SL-S651C (P, PC) : 0.4W/0.45W

When recharging:

SL-S650 (P) / SL-S651C (P, PC) : 5.0W

SL-S650 (EB, EG, GC, GN) : 5.9W

Dimensions :

128(Wide)/25.7(High)/142(Depth) mm

5 1/16 (Wide)/1(High)/5 9/16 (Depth) inch

Weight:

275 g (9.7 oz) (with batteries)

230 g (8.1 oz) (without batteries)

*These specifications were measured in the EXTRA ANTI-SHOCK OFF mode.

Note: Specifications are subject to change without notice.

Weight and dimensions are approximate.

Panasonic®

© 1997 Matsushita Electric Industrial Co., Ltd.
All rights reserved. Unauthorized copying and distribution is a violation of law.

⚠ WARNING

This service information is designed for experienced repair technicians only and is not designed for use by the general public. It does not contain warnings or cautions to advise non-technical individuals of potential dangers in attempting to service a product. Products powered by electricity should be serviced or repaired only by experienced professional technicians. Any attempt to service or repair the product or products dealt with in this service information by anyone else could result in serious injury or death.

■ Contents

	Page		Page
Precaution of Laser Diode	2,3	Automatic Adjustment Results	
Accessories	3	Display Function (Self-check Function)	20,21
Location of Controls	3	Measurements and Adjustments	21,22
Power Supply Preparations	4	Outline of 10-Second Sound Keeper Technique	
Sequential Play	5	Used for Prevention of Sound from Skipping	23
Other Play Methods	6	Type Illustration of IC's, Transistors and Diodes	23
Accidental Operation Prevention Function	6	Block Diagram	24 ~ 27
Extra Anti-Shock Function	7	Schematic Diagram	28 ~ 33
Using Wireless Remote Controller (SL-S651C only)	7	Printed Circuit Board and	
Using the Unit with Optional Accessories	8	Wiring Connection Diagram	34,35
Maintaining the Lens	8	Terminal Function of IC's	36 ~ 40
Cautions	8	Replacement Parts List (Electrical and Cabinet)	41,42
Car Kit Installation (SL-S651C only)	9 ~ 11	Cabinet Parts Location	43
Handling Precautions for Traverse Deck	12	Resistors and Capacitors	44,45
Operation Checks and Main		Replacement Parts List (Packing, Accessories and Jig)	48
Component Replacement Procedures	13 ~ 18	Packaging	47,48
Checking the Operation Problems on			
the Traverse Deck (Optical Pickup)	19		

■ Precaution of Laser Diode**● For (P, PC) areas.**

CAUTION: This unit utilizes a class 1 laser. Invisible laser radiation is emitted from the optical pickup lens when the unit is turned on :

1. Do not look directly into the pickup lens.
2. Do not use optical instruments to look at the pickup lens.
3. Do not adjust the preset variable resistor on the optical pickup.
4. Do not disassemble the optical pickup unit.
5. If the optical pickup is replaced, use the manufactures specified replacement pickup only.
6. Use of control or adjustments or performance of procedures other than those specified herein may result in hazardous radiation exposure.

● For (EB,EG,GC,GN) areas.

CAUTION: This product utilizes a laser diode with the unit turned "on", invisible laser radiation is emitted from the pickup lens.
Wave length: 780 nm
Maximum output radiation power from pickup: 100 μ W/VDE

Laser radiation from the pickup lens is safety level, but be sure the followings:

1. Do not disassemble the optical pickup unit, since radiation from exposed laser diode is dangerous.
2. Do not adjust the variable resistor on the pickup unit. It was already adjusted.
3. Do not look at the focus lens using optical instruments.
4. Recommend not to look at pickup lens for a long time.

ACHTUNG: Dieses Produkt enthält eine Laserdiode. Im eingeschalteten Zustand wird unsichtbare Laserstrahlung von der Lasereinheit abgestrahlt.

Wellenlänge: 780 nm
Maximale Strahlungsleistung der Lasereinheit: 100 μ W/VDE

Die Strahlung an der Lasereinheit ist ungefährlich, wenn folgende Punkte beachtet werden:

1. Die Lasereinheit nicht zerlegen, da die Strahlung an der freigelegten Laserdiode gefährlich ist.
2. Den werkseitig justierten Einstellregler der Lasereinheit nicht verstellen.
3. Nicht mit optischen Instrumenten in die Fokussierlines blicken.
4. Nicht über längere Zeit in die Fokussierlines blicken.

ADVASEL: I dette a apparat anvendes laser.

RQLS0072-2

● Bottom side

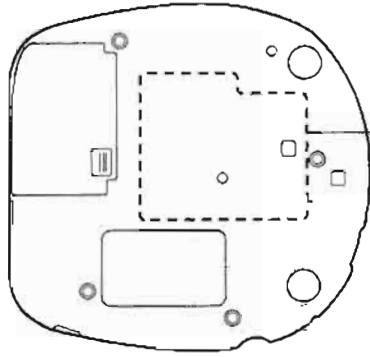

CLASS 1 LASER PRODUCT

VARO! Avaruutta on suojattava ohittamalla tai alustaa näkymättä laserisäteilylle. Älä katso silmiin.

ADVARSEL! USYNLIG LASERSTRÅLING. VED ÅBNING, NÅR SIKKERHEDSÅF BRYDERE ER UD AF FUNKTION, UNDGÅ UDSÆTTELSE FOR STRÅLING.

VARO! Uusung laserstråling när denna del är öppnad och spårren är utsläppt. Betrakta ej strålen.

YORSIEM! Uusung laserstråling. VED ÅBNING, NÅR SIKKERHEDSÅF BRYDERE ER UD AF FUNKTION, UNDGÅ UDSÆTTELSE FOR STRÅLING.

DANGER! Invisible laser radiation when open and antenna depressed. AVOID DIRECT EXPOSURE TO BEAM.

ADVARSEL! Uusung laserstråling när dehet åpnes og sikkerhedsås brytes. Unngå eksponering for strålen. RQLS0072-2

Accessories

● SL-S650 (P,EB,EG,GC,GN)

- AC adaptor 1 pc
(RFEA403C-S): For (P) area. (RFEA404B-1W): For (EB) area.
(RFEA401E-3S): For (EG) area. (RFEA403Z-S): For (GC) area.
(RFEA403A-S): For (GN) area.
- Stereo earphones (RFEV316P-K1S) 1 pc.
- Wired remote controller (RFEV006PCKM) 1 pc.
- Soft case 1 pc.
(RFC0041-K): For (EB,EG,GC,GN) areas.
- Battery case (RFA0627-K4) 1 pc.
- Rechargeable battery ass'y 1 pc.
(RFKFP3GAVE2S): For (EB,EG) areas.
(RFKFP3GAVT2S): For (GC,GN) areas.

- Battery carrying case ass'y 1 pc.
(RFKNLS370-K): For (EB,EG,GC,GN) areas.
- Power plug adaptor 1 pc
(SJP5213-2): For (GC) area.

● SL-S651C (P,PC)

- AC adaptor (RFEA403C-S) 1 pc.
- Stereo earphones (RFEV317P-KS) 1 pc.
- Wireless remote controller (EURNTR1026P) 1 pc.
- Car adaptor (SH-CDC2PPY) 1 pc.
- Car stereo cassette adaptor (SH-CDM8ASY-K) 1 pc.

Location of Controls

A

Back panel of the unit

B

C

● For (P, PC) areas.

BATTERY SERVICE LIFE

● For SL-S650 only

Approx. 6.5 (Extra anti-shock OFF) hours/4.5 (Extra anti-shock ON) hours (EIAJ) with rechargeable batteries.
 Approx. 20 (Extra anti-shock OFF) hours/13 (Extra anti-shock ON) hours (EIAJ) with two Panasonic AM-3/LR6 alkaline (AA-size) batteries.
 Approx. 45 (Extra anti-shock OFF) hours/30 (Extra anti-shock ON) hours (EIAJ) with four Panasonic AM-3/LR6 alkaline (AA-size) batteries.

● For SL-S651C only

Approx. 5 (Extra anti-shock OFF) hours/3.5 (Extra anti-shock ON) hours (EIAJ) with rechargeable batteries.
 Approx. 18 (Extra anti-shock OFF) hours/12 (Extra anti-shock ON) hours (EIAJ) with two Panasonic AM-3/LR6 alkaline (AA-size) batteries.
 The above battery service life is measured according to the conditions set forth by EIAJ (Electronic Industries Association of Japan). As the battery service life varies with the method of operation and environmental conditions, use these values as reference.

Portable CD player

- A** Skip/search buttons (◀◀, ▶▶/◀, ▶)
- B** Memory/recall button (MEMORY/RECALL)
- C** Repeat button (REPEAT)
- D** Stop/power off button (■, POWER OFF)
- E** Display
- F** Play/pause button (▶ ||)
- G** DC in jack (DC IN 4.5 V ⚡)
- H** Out jack (OUT)
- I** Play mode selector (RESUME, NORMAL, RANDOM)
- J** LIVE/XBS selector (LIVE, XBS, OFF)
- K** Headphones jack (⌚) ϕ 3.5 16 Ω
- L** Headphones volume control (VOLUME)
- M** Open button (OPEN)
- N** Extra anti-shock switch (EXTRA ANTI-SHOCK)
- O** Hold switch (HOLD-LOCK)
- P** Remote sensor
- Q** Push button (PUSH)
- R** Connection terminal for battery case
- S** Hole for car mounting base/battery case

Wired remote controller

SL-S650 ONLY

- 1** Display
- 2** Play/stop/off button
- 3** Repeat button (REPEAT)
- 4** Skip/search buttons (◀◀, ▶▶)
- 5** Light/hold button (-LIGHT/ = HOLD)
- 6** Clip
- 7** Volume control
- 8** Plug

Wireless remote controller

SL-S651C ONLY

- 1** Transmission window
- 2** Operation/battery indicator (OPR/BATT)
- 3** A-B repeat (A-B REPEAT)
- 4** Repeat button (REPEAT)
- 5** Music scan button (M. SCAN)
- 6** Light button (LIGHT)
- 7** Play/pause button (▶ ||)
- 8** Stop/power off button (■)
- 9** Skip/search button (◀◀, ▶▶)
- 10** Volume control (-, +, LEVEL)

Power Supply Preparations

- Refer to the specifications (cover page) for information on operating times when using rechargeable batteries or dry-cell batteries.
- The illustrations show model SL-S650.

Using rechargeable batteries (not included)

Obtain the optional rechargeable batteries (SH-CDB8D, P-3GAVE/2B, P-3GAVT/2B).
Make sure to recharge the batteries before using them. The unit cannot be used to charge rechargeable batteries other than SH-CDB8D (P-3GAVE/2B, P-3GAVT/2B).

Recharging procedure

- 1 Insert the special rechargeable batteries into the unit.

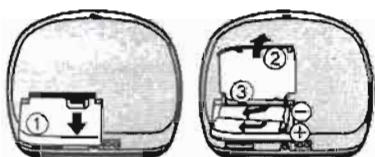

- 2 Connect the AC adaptor.

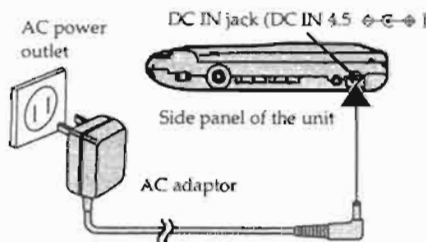

- 3 When recharging is complete, unplug the AC adaptor from the power outlet and the DC IN jack.

Notes

- It takes approximately three hours to fully recharge the rechargeable batteries.
- Rechargeable batteries have a service life of approximately 300 charge-discharge cycles. If the operating time on one full charge becomes noticeably shorter than it used to be, the battery has reached the end of its service life and should be replaced.
- Recharging may only be performed when the unit is powered off. (It is not possible to recharge the batteries while playing a CD.)
- The AC adaptor and rechargeable batteries may become warm while recharging is in progress. This is not a malfunction.

- For (GC) area only.

AC adaptor

Before use

Make sure the preset voltage of your AC adaptor fits to your local voltage before plugging it into the AC power outlet. If it doesn't, turn the AC line-voltage selector with a screwdriver so that it corresponds to your local voltage. **A**

If the power plug will not fit your socket, use the power plug adaptor. **B**

How to use the AC adaptor

To connect the AC adaptor, refer to "Using rechargeable batteries."

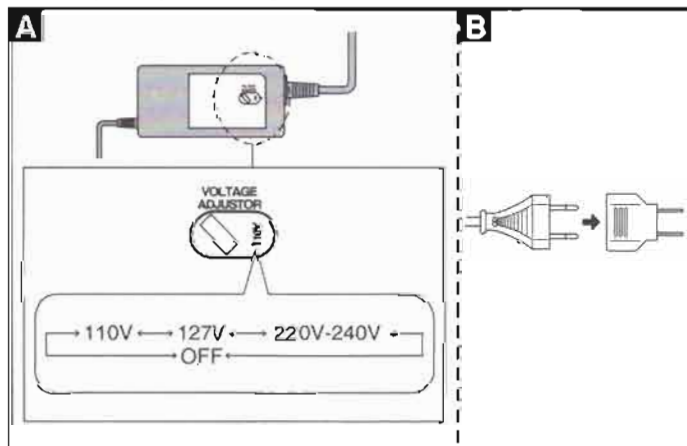

If the battery lid comes loose

Slide the lid back into place horizontally.



Removing batteries

Push up on the battery in the direction indicated by the arrow. Then lift it out.



Using the AC adaptor

Connect the AC adaptor supplied.

Refer to "Using rechargeable batteries" for connection instructions.

Using the car adaptor

The SL-S651C comes with a car adaptor. Be sure to use the adaptor specially designed for this model. (Refer to the separate installation instructions.)

The car adaptor (SH-CDC9) is available as an optional accessory for the SL-S650.

CAUTION: (SL-S650)

Use only car adaptor, Model: SH-CDC9 manufactured by Matsushita Electric Industrial Co., Ltd.

The car adaptor can be used to recharge the unit's batteries while in the car.

Using dry-cell batteries (not included)

After disconnecting the AC adaptor, insert two "AA" (LR6) alkaline batteries.

The procedure for inserting and removing dry-cell batteries is identical to that for rechargeable batteries.

Battery indicator



This indicator flashes when the batteries are almost out of power. Power is cut off completely a short while later.

Rechargeable batteries: Recharge batteries.
Dry-cell batteries: Replace batteries with new ones.

Notes

- The length of time the unit will continue to operate after the battery indicator starts flashing depends on the type of batteries used.
- The battery indicator may not flash if rechargeable batteries, other than those designated by Panasonic, are used.

Using the battery case **SL-S650 ONLY**

The battery case allows you to extend the maximum playing time of the unit by loading an additional two "AA" (LR6) alkaline batteries.

Notes

- When using the battery case, always insert batteries in the unit body as well. (The unit cannot be operated on the batteries in the external battery case alone.)
- Do not use rechargeable batteries in the battery case.
- When using rechargeable batteries in the unit body, and dry-cell batteries in the battery case, be sure to use fully charged rechargeable batteries and new dry-cell batteries.
- When using four dry-cell batteries, do not mix new and old batteries.

- 1 Open the cover of the battery case and insert the batteries.

Insert the end marked (-) first.



- 2 Mount the battery case on the unit body.

Insert the protrusions on the battery case into the four indentations in the unit body.

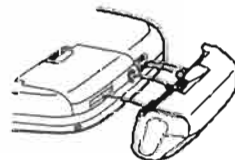

- 3 Secure in place with the screw.

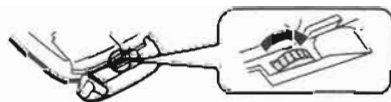

Reverse the above procedure to remove the external battery case.

For your reference:

The maximum playing time will differ depending on the type of batteries (rechargeable/dry-cell) loaded in the unit body.

If the cover of the battery case comes loose:

Insert the protrusions into the holes on either end of the lid.

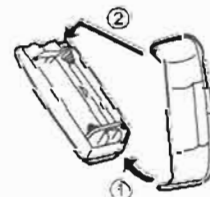

Sequential Play

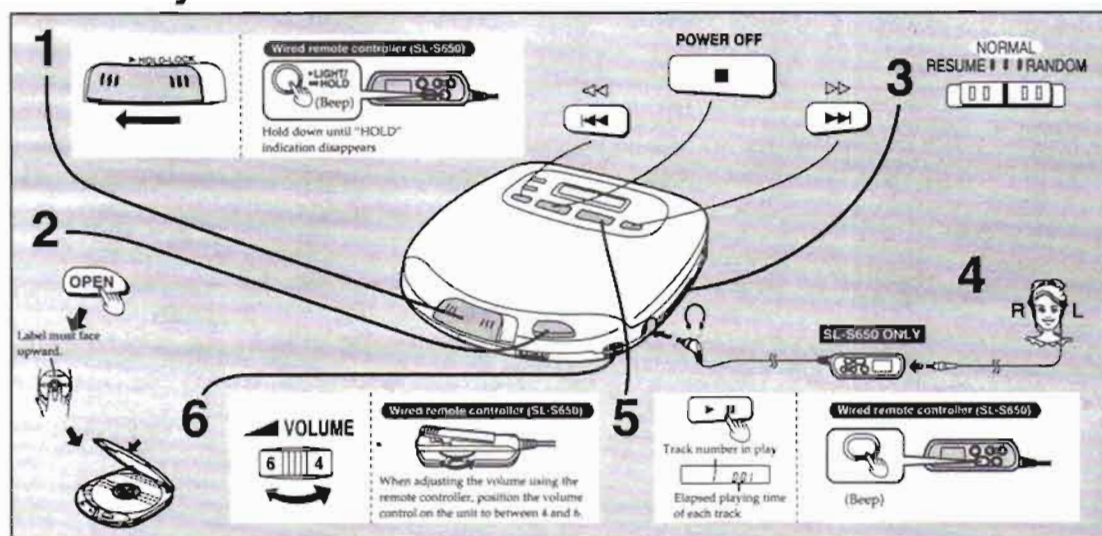

Following steps 1–6.

In step 4, connect the stereo earphones to the jack. (Plug in firmly)

• Play stops automatically when all the tracks have been played.

• If the unit has been connected to the car audio system, adjust the volume level between 4 and 6 on the unit, then adjust the volume level on the system.

Operation	Unit	Wired remote controller SL-S650 ONLY
To pause play	Press during play Press again to resume play	The wired remote controller cannot be used to pause play.
To stop play Stop mode	Press during play POWER OFF Total number of tracks 10 44:48 Total playing time	Press once during play (Beep)
To turn off the unit Off mode	Press during stop mode POWER OFF 	Press and hold during play or stop mode (Beep...p)
Skip forward/backward (skip function)	Press during play Backward Forward • During program play, these buttons are used to skip forward or back through the programmed sequence of tracks. • During random play, the skip buttons cannot be used to skip back to tracks that were played previously in the random sequence. • During program play, random play or 1 track repeat play, search operation is limited to the current track only. (See page 4.)	Press once during play Backward Forward (Beep Beep Beep) (Beep Beep)
Rapid forward/backward (search function)	Keep depressed during play	Press and hold during play

Lighting of the function buttons and backlight
(Function buttons light on SL-S651C model only.)

Type of power supply	When car adaptor or AC adaptor is used	When batteries are used (HOLD mode released)
Function button/backlight		
MEMORY/RECALL	On	On for approx. 5 sec. when any function button (except OPEN) is pressed.
REPEAT		Off
■/POWER OFF		
Display panel		
▶ II	On: Flashes rapidly: Flashes slowly: For your reference: If the HOLD mode is engaged when batteries are used to operate the unit, the function button lights switch off in order to conserve the batteries' charge.	During play: • When play is started from the POWER OFF (or stop) mode • When the skip function has been used

Using the wired remote controller SL-S650 ONLY

The wired remote controller can be operated regardless of the hold mode of the unit.

Display panel illumination

When hold status is canceled and the remote control is operated, the display panel illuminates for approximately five seconds. This is useful when operating the unit in a dark location.

Also, the display panel illuminates when the •LIGHT/■HOLD button is pressed once while the unit is in hold status.

Operation confirmation beep

When an operation button is pressed, a confirmation beep sounds. However, no confirmation beep sounds when the •LIGHT/■HOLD button is pressed once (causing the display panel to illuminate). Refer to the explanations in parentheses () in the illustration above, etc., for information on the different types of confirmation beeps that sound.

Removing discs

After the disc has stopped rotating, press the PUSH button to release the disc. (To protect the disc, never open the cover while it is playing.)

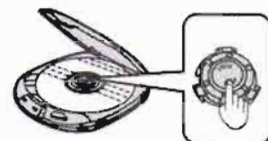

Note

Never insert foreign objects into the unit body.

For your reference

"no disc" indication

This indication appears for about 30 seconds if the ▶ II button is pressed when no disc is loaded in the unit or if the disc is not completely seated.

"OPEN" indication

This indication appears for about 10 minutes when the cover is opened. (However, the indication does not appear when the unit is powered off.)

Auto power off function

If the unit is left in stop or paused status for approximately 10 minutes, the unit powers itself off automatically in order to prevent the batteries from running down.

Other Play Methods

The letters such as **A** in the various illustrations refer to the descriptions in the "Location of Controls" section.

Skip play

The disc plays from the specific track through to the last track, then play stops automatically.





Preparation: Put unit in stop mode. (See page 5.)

- 1 
- 2 Select the desired track. 
- 3 

Program play

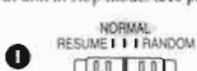
Up to 24 tracks can be entered in the programmed sequence.

Preparation: Put unit in stop mode. (See page 5.)

- 1 
- 2 Select the desired track. 
- 3 Register in sequence. (The indication "M" and the programmed sequence appear on the display panel.) 
- 4 Repeat steps 2 and 3 to program all the desired tracks.
- 5 

■ To program the same track in the sequence more than once

After step 3, press MEMORY/RECALL the desired number of times.

■ If "f" is displayed

No more tracks may be added to the sequence.

Accidental Operation Prevention Function

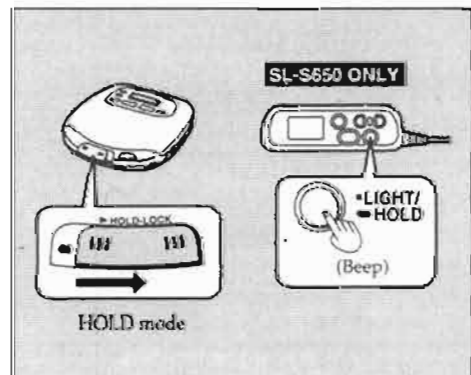

This function causes the unit to ignore short, accidental button presses. (When the unit is in HOLD status, the cover will not open even when the OPEN button is pressed.)

The misoperation prevention function prevents the following:

- Powering on the unit accidentally (which can cause the batteries to go dead).
- Play being cut off unexpectedly in the middle of a selection.
- The cover opening unexpectedly in the middle of a selection.

The unit body and wired remote controller are equipped with a HOLD-LOCK slider and a HOLD button, respectively, and each operates independently of the other to activate HOLD status.

(Only SL-S650 is supplied with the wired remote controller.)



■ To confirm the contents of the programmed sequence

Press MEMORY/RECALL while the disc is playing. (The numbers of the programmed tracks appear on the display panel in sequence.)

■ To delete the entire programmed sequence

Press ■, POWER OFF.

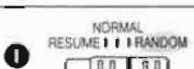
Random play

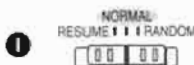
- 1 
 - 2 
- Release 

For your reference:

- It is also possible to press the ►► button while the unit is in stop status to change the first track to be played. (All tracks are played eventually, regardless of which is played first.)
- Program play is not possible in the random mode.

Resume play

This function allows you to listen from the beginning of the track where play stopped because the unit was powered off (or switched to stop status). It is useful when listening to CDs in the car, etc.

- 1 
- 2 

For your reference:

- If the RESUME, NORMAL, RANDOM (play mode switch) slider is put in the RESUME position, the all-repeat function will be activated automatically as soon as the unit is powered on.
- If power is cut off near the end of a track (power off status), playback may resume from the beginning of the next track in some cases.
- If the unit is powered off while a disc was playing and then a new disc is inserted, play will begin from the middle of the new disc because the unit remembers the position where play stopped on the previous disc.

Repeat function

Press REPEAT while disc is playing or when unit is in stop status.

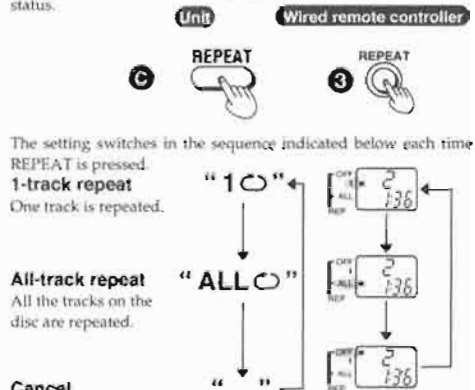

For your reference:

- If REPEAT is pressed during program play, only the tracks in the programmed sequence are repeated. (The indication "ALL" is not displayed.)
- When the repeat button of the remote controller is operated, the sound will be interrupted for an instant. This is normal and not indicative of a malfunction.

Changing the sound quality

LIVE:

Select this setting to reproduce the sound as if it would be heard in a concert hall.



XBS:

Select this setting to boost the low-range response.



OFF:

Select this setting to turn off the XBS function.



Note

The sound quality setting does not affect the output from the OUT (analogue output) jack.

To use the accidental operation prevention function

Slide the HOLD-LOCK slider on the unit body to the HOLD position. (The wired remote controller still functions.)

Hold down the HOLD button on the wired remote controller until the confirmation beep sounds. (The controls on the unit body still function.)

"hold"/"HOLD" indication

Unit body: When the unit is in HOLD status, pressing any operation button (other than the OPEN button) causes the indication "hold" to appear on the display.

When the unit is powered off

The "hold" indication appears only when the ►|| button is pressed.

Wired remote controller: The indication "HOLD" appears on the display when HOLD status is activated.

Extra Anti-shock Function

This function minimizes sound interruption when vibrations are encountered by utilizing audio data that has been stored ahead of time (up to approximately 10 seconds' worth).

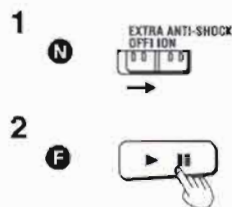

Notes

- The position of the EXTRA ANTI-SHOCK slider can be changed during play, but this may cause a slight interruption in the sound because the disc's rotational speed changes.
- During the extra anti-shock operation, the disc rotates at a higher rate than usual in order to collect extra audio data. This may cause the batteries to run out faster and could result in a slight increase in disc rotation noise.

Using the unit with an audio system

The extra anti-shock function uses digital signal compression technology. It is recommended that the extra anti-shock slider be kept in the OFF position if the unit is connected to a home audio system.

M.RESERVE indicator status	Unit body status	Play status (audio data status)
	Stable	Normal (plenty of data is stored)
	Bump encountered	Normal (stored data is used)
	Bumping stops	Normal (data again starts to be stored)
	Bumps continue repeatedly	Sound is interrupted (data buffer empty)

Using Wireless Remote Controller (SL-S651C only)

The wireless remote controller can be operated regardless of the hold mode of the unit.

Preparation:

Insert the dry cell batteries into the wireless remote controller.

Check the ⊕ and ⊖ polarities and align them properly when inserting the dry cell batteries.

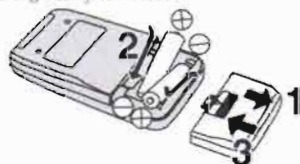

Removing the batteries

Push the batteries upward in the direction of the arrow to remove them.

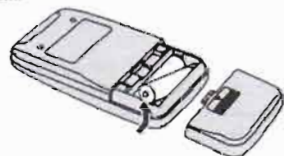

Notes

- Do not place any object which will block the path of the signals between the remote controller and the unit.
- Do not allow the remote sensor or transmitter to become dusty.
- Do not leave the remote controller standing in direct sunlight or in high temperature locations in a car.
- In the interest of traffic safety, do not operate the remote controller while driving.

Operation

Preparation:

When the unit is to be operated using batteries, first press ► II on the unit and then use the remote controller. (The unit cannot be operated by the remote controller while the unit is turned off.)

Adjust volume level of speaker and stereo earphones. <ul style="list-style-type: none"> The level can be adjusted from 0 dB to -21 dB. The 0 dB level is restored when the unit is turned off. To adjust the volume When adjusting the volume using the wireless remote controller, position the volume control on the unit to 4-6.		Point the transmitter on the remote controller at the remote sensor on the unit.
<ul style="list-style-type: none"> Blinks when a button on the remote control is pressed. Failure to flash indicates that the batteries have worn out. 		<p>Use the remote controller within a 7-meter range of the remote sensor on the unit. (Depending on the angle of the controller, the signals may not reach the sensor.)</p>
Skip tracks (tap). Rapidly searches forward or backward during play (keep depressed).		
Repeats the section to be heard (A-B repeat).		
Stops play/turns the unit off when kept depressed.		
Initiates play/establishes pause mode when pressed again.		
Repeat all tracks or single track.		
When pressed once, the buttons on the remote control lights up for about five seconds.		
Listen to the beginning portion (intro) of each track in order (Music scan).		

To repeat a particular section (A-B repeat)

Press during play

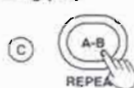

The setting and the indication switch in the sequence indicated in the right each time A-B REPEAT is pressed.

Point A
Where repeat play is to be started.

Point B
Where repeat play is to be ended.

Cancel
Normal play is restored.

Note

A-B repeat play is not possible during program play or random play.

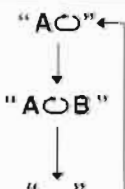

Music scan play

Allows you to listen to the beginning portion (intro) of the tracks of a CD for 15 seconds each, in order. This is useful when playing discs inside a car.

Preparation:

Set the unit to the stop mode. (See page 3.)



After the beginning portion (15 seconds) of each track has been played, normal playback begins starting with the first track. (While this function is on the indication "M.SCAN" appears on the display panel.)

To cancel the M.SCAN mode

During playback of the intro of the desired track, press ► II (The unit returns to normal playback.)

Using the Unit with Optional Accessories

Using the unit with an audio system

Using the stereo connection cable (not included), you can listen to CDs on your audio system.

- Turn off the amplifier power and connect the cable.
- Do not connect the cable to the PHONO jacks on the amplifier.
- Obtain the optional connection cable if the amplifier comes with mini-phone jacks.
- Adjust the volume level on the amplifier.

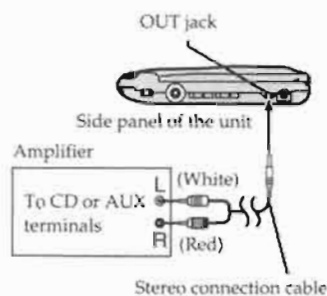

Using the unit with a car audio system stereo

The SL-S651C comes with the car adaptor and the car stereo cassette adaptor.

Items to be purchased

For connection to the car audio system: **SL-S650 ONLY**

- Car stereo cassette adaptor (SH-CDM9A)
- Car adaptor (SH-CDC9)

Connect the car stereo cassette adaptor to the unit's headphone jack. (When doing this, keep the unit's VOLUME control at a setting between 4 and 6.)

For securing the unit and connecting the power supply:

Car mounting kit (SH-CDF20)

Note

It may not be possible to use the unit with some types of car stereo owing to restrictions imposed by the construction of the car stereo cassette adaptor.

For further details, refer to the instructions of the part concerned.

Maintaining the Lens

Open the lid and clean the lens as shown in the figure. Use a cotton swab to gently wipe off any finger-prints. Recommended product: Lens cleaner kit (SZZP1038C)

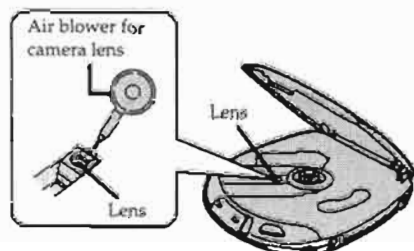

Cautions

Listening caution



Do not play your headphones or earphones at a high volume. Hearing experts advise against continuous extended play.

If you experience a ringing in your ears, reduce volume or discontinue use.

Do not use while operating a motorized vehicle. It may create a traffic hazard and is illegal in many areas.

You should use extreme caution or temporarily discontinue use in potentially hazardous situations.

Even if your headphones or earphones is an open-air type designed to let you hear outside sounds, don't turn up the volume so high that you can't hear what's around you.

Sound can be deceiving. Over time your hearing "comfort level" adapts to higher volumes of sound. So what sounds "normal" can actually be loud and harmful to your hearing.

Guard against this by setting your equipment at a safe level BEFORE your hearing adapts.

To establish a safe level:

- Start your volume control at a low setting.
- Slowly increase the sound until you can hear it comfortably and clearly, and without distortion.

Once you have established a comfortable sound level:

- Set the dial and leave it there.



Rechargeable batteries

• Only the SH-CDB8D (P-3GA/E/2B, P-3GAVT/2B) batteries can be recharged.

• If the power delivered by the batteries lasts for a very short time after recharging, it means that the batteries' service life is over. Do not use them any more.

• Recharging already charged batteries will shorten their service life.

• When recharging batteries for the first time or when they have not been used for a long period of time, the play time may be shorter than usual. In a case like this, repeatedly recharge and discharge the batteries. This will restore them to their regular state.

• Do not allow any metal objects to touch the terminals of rechargeable batteries since this may cause short-circuiting which is dangerous.

• Do not peel off the plastic covering on the rechargeable batteries. Short-circuiting may occur which is dangerous.

• Do not insert rechargeable batteries into the battery case.

Dry cell batteries/rechargeable batteries

To prevent damage to the batteries and electrolyte leakage, heed the following points.

• Align the ⊕ and ⊖ polarities properly when inserting the batteries.

• Do not mix different types or makes of batteries or old and new batteries.

• Remove the batteries if you do not plan to use the unit for a long period of time.

• Do not throw batteries into a fire, and do not short-circuit, disassemble or subject them to excessive heat.

• Do not attempt to recharge dry cell batteries.

• Do not peel off the plastic covering on the rechargeable batteries. Short-circuiting may occur which is dangerous.

Carrying dry cell batteries/rechargeable batteries around

When putting dry cell or rechargeable batteries in a pocket or bag, ensure that no other metal objects such as a necklace are placed together with them. Contact with metal may cause short-circuiting which, in turn, may cause a fire.

Be absolutely sure to carry the rechargeable batteries in the battery carrying case.

When purchasing rechargeable batteries

As a safety precaution, the portable CD players made by Panasonic have a construction designed to make it impossible to recharge ordinary batteries.

To use rechargeable batteries, be absolutely sure to purchase the rechargeable Ni-Cd batteries designed especially for this unit.

Special rechargeable Ni-Cd batteries:

SH-CDB8D (P-3GA/E/2B, P-3GAVT/2B) (set of 2)

For details, check with your dealer.

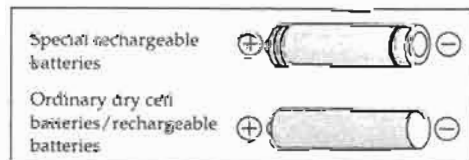

When driving a car

In the interest of traffic safety, do not operate the unit while driving.

■ Car Kit Installation (SL-S651C only)

Connections

Adjust the volume level:
 ● 4 to 6 for the CD player
 ● as desired for the car audio system

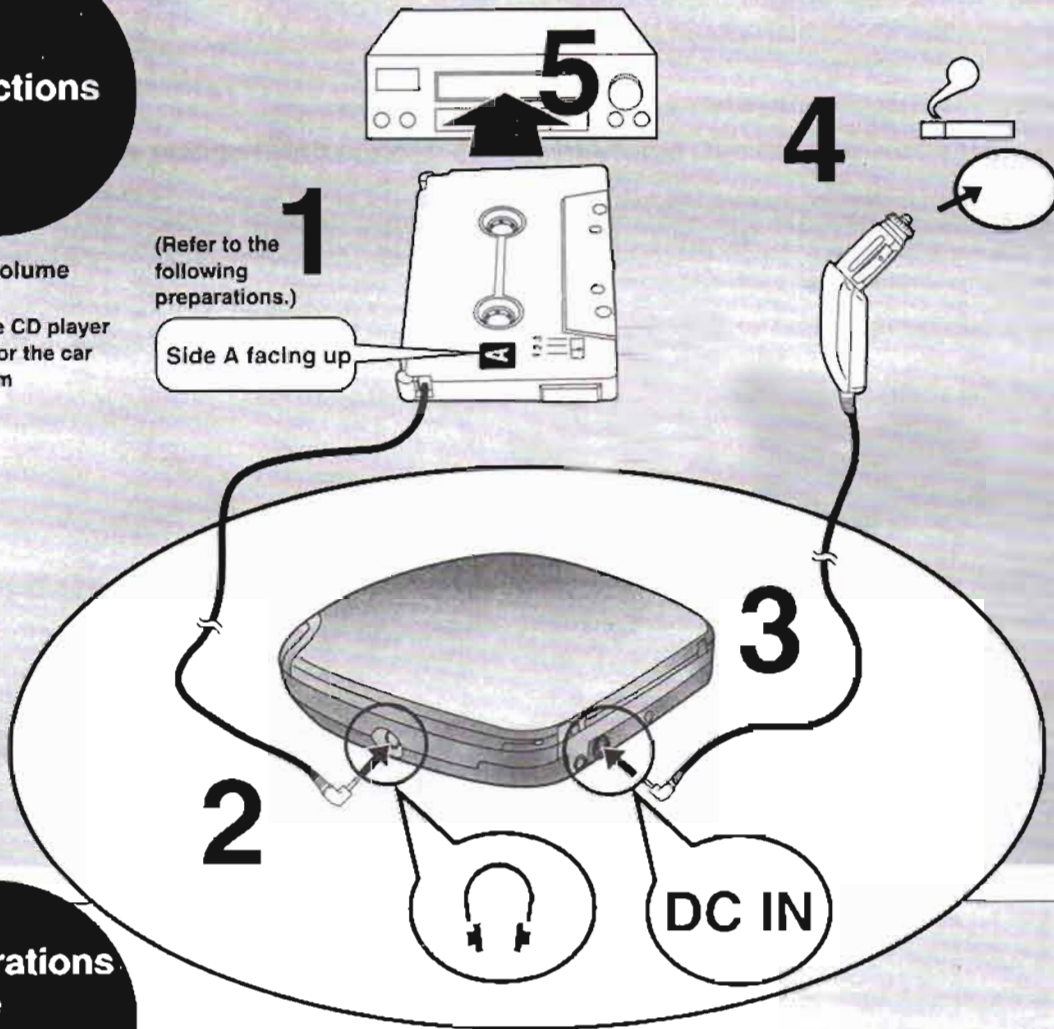

Preparations for the cassette adaptor

For a car audio system with the head at the right side



It can be used as it is.

For a car audio system with the head at the left side

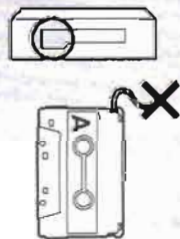

For a car audio system in which the head is in the center at the rear

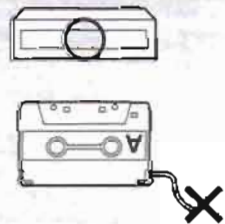

Change the direction in which the cord is led out.

Refer to the back side "To change the cord direction" for details.

● For securing the portable CD player in a car

Optional Car Mount Kit (the car mounting arm/car insulator or car mounting base) make it easy to secure the product inside your car. There are two types of car mounting kits; the SH-CDF7 and SH-CDF20. Therefore, be sure to check "Using the Unit with Optional Accessories" in the Operating Instructions to determine the correct car mounting kit.

● When the sound volume is extremely low

- ① Set the play direction for the car audio system to the forward (FWD) direction.

If the sound volume is still low:

- ② Adjust the cassette adaptor's head position selector.

Set the cassette adaptor's head position selector to 1, 2 or 3, whichever yields the highest volume level.

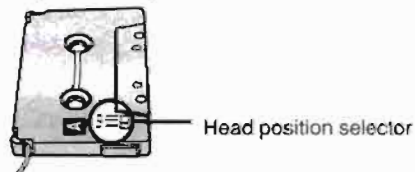

● Concerning the Car Audio System

■ For an auto-reverse car audio system

Position the cassette adaptor with side A facing up and set the play direction for the car audio system to the forward (FWD) direction. The head positions of the cassette adaptor and the car audio system do not match in the reverse direction, causing the sound volume from the speakers to be extremely low.

● Cautions

Please understand that we cannot take responsibility for the unit falling or any other damage that may occur as a result of faulty installation.

■ Car adaptor

- The provided car adaptor is made specifically for use with DC 4.5 V Panasonic portable CD players. Do not use it with other devices.
- Do not use the adaptor for a long period with the batteries left in the unit because this may shorten the life of the batteries.
- Pay attention to the car battery capacity when using this adaptor for a long period.
- Do not expose this adaptor to strong sunlight or very high temperatures.
- Be sure to remove this adaptor from the cigarette lighter socket when not using this adaptor or before leaving the automobile.
- The power source polarities of this unit are \ominus \oplus \ominus , check the DC IN jack.

- The sound quality deteriorates when the head section of the car audio system becomes dirty. It is, therefore, a good idea to clean it periodically.
- If the rollers or car audio capstan are dirty, it may not longer be possible to install the cassette adaptor in the car audio system. Clean the rollers and capstan using a cotton swab.
- Do not leave this adaptor in a vehicle which is exposed to direct sunlight.
- Do not bring any magnetized objects near this adaptor's head position.
- Because of the nature of its construction, the sound of something rotating can be heard in this adaptor. This is normal and not indicative of a malfunction.
- During the winter months when the temperature inside the vehicle falls to an extremely low level, there may be times when the unit cannot be used because the cord is too stiff to allow the adaptor to be installed in its proper position.

■ Cassette adaptor

- Blunch the excess cord together or place it so that it will not interfere with operation.
- Do not touch the head or roller.
- A protective film has been placed over the heads to prevent them from being damaged. Do not remove this film.

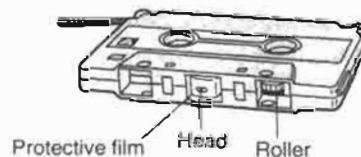

- After use, remove the cassette adaptor and keep it so that no dust will adhere to the head section.
- After installing the cassette adaptor in the car audio system, do not allow its cord to make contact with the control section.

● To change the cord direction

With some car audio systems it is necessary to change the direction in which the cord is led out.

1 Remove the cover of the cassette adaptor.

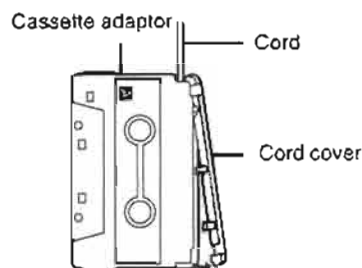

2 Pull out the cord, align it with the head section of the car audio system, and change the position from which it extends.

For a car audio system with the head at the left side

For a car audio system in which the head is in the center at the rear

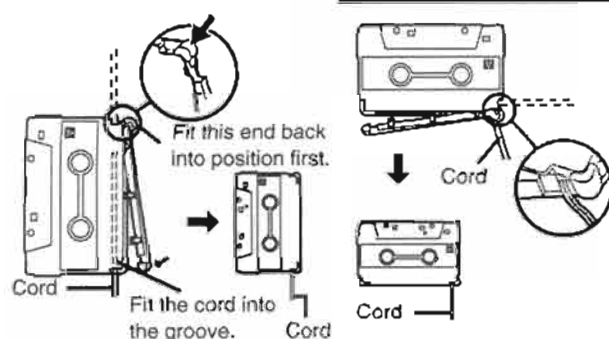

● Car adaptor

The provided car adaptor must be connected.

- This car adaptor can be used in an automobile which has a 12 V or 24 V battery. You can use it in a truck or other large vehicle. (This is a special-purpose negative ground car adaptor.)
- Do not connect the adaptor immediately after using the cigarette lighter.
- Leave a little slack in the car adaptor's cord, making sure that it does not run underneath the unit.

■ To replace the fuse

1 Remove the plug cap by rotating it in the direction shown by the arrow, and take out the old fuse.

2 Insert the new fuse (125 V, 500 mA type) into the fuse receptacle and reinstall the plug cap.

Note:

For continued protection against risk of fire, replace only with same type 125 V, 500 mA fuse.

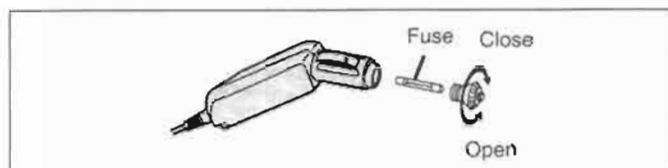

If the fuse blows frequently, there may be something wrong with the adaptor. Consult your dealer.

● Car audio system

■ When the car audio system has a blank skip function

The blank skip function may operate when the CD player stops. Therefore, be sure to set the blank skip function to off.

Note:

Depending on the type of vehicle, static may be heard if the unit is connected via line cord to the car audio system's CD IN jack or AUX IN jack. If this occurs, it is recommended that you use the provided cassette adaptor.

When you leave the car

Push the eject button to remove the cassette adaptor.

● Troubleshooting guide

Before requesting service for this unit, check the chart below for a possible cause of the problem you are experiencing. Some simple checks or a minor adjustment on your part may eliminate the problem and restore proper operation.

If you are in doubt about some of the check points, or if the remedies indicated in the chart do not solve the problem, refer to the directory of Authorized Service Centers (enclosed with this unit) to locate a convenient service center, or consult your dealer for instructions.

(In U.S.A. consult PASC Authorized Servicenters for detailed instructions or call 1-800-545-2672 for the address of an authorized factory servicenter.)

Problem	Checkpoint	Remedy
The sound volume is extremely low.	Did you adjust the volume level of the unit?	Adjust the volume level of the unit to 4-6.
	Did you adjust the volume level of the car audio system?	Adjust the volume level of the car audio system to the desired level.
	Did you adjust the cassette adaptor's head position selector?	Set the sound to the highest volume level.
	Have you removed the cord cover of the cassette adaptor?	Install the cord cover properly.
	Does the car audio system have an auto-reverse function?	Set the play direction for the car audio system to the forward (FWD) direction. [The forward (FWD) direction is the side which produces sound or which has the greatest sound volume.]
The cassette adaptor cannot be inserted into the car audio system.	Did you check the position of the head?	Check the position of the head in relation to the car audio system to ensure the cassette adaptor is installed correctly.
	Have you inserted the side with the cord in first?	Remove the cord cover, and change the position from which the cord extends.
The unit cannot be turned on.	Is the fuse for the car adaptor blown?	Insert a new fuse.

■ Handling Precautions for Traverse Deck

The laser diode in the traverse deck (optical pickup) may break down due to potential difference caused by static electricity of clothes or human body.

So, be careful of electrostatic breakdown during repair of the traverse deck (optical pickup).

● Handling of traverse deck (optical pickup)

1. Do not subject the traverse deck (optical pickup) to static electricity as it is extremely sensitive to electrical shock.
2. The short land between the No.⑫ (LD GND) and No. ⑬ (LD) pins on the flexible board (FFC) is shorted with a solder build-up to prevent damage to the laser diode. To connect to the PC board, be sure to open by removing the solder build-up, and finish the work quickly.
3. Take care not to apply excessive stress to the flexible board (FFC).
4. Do not turn the variable resistor (laser power adjustment). It has already been adjusted.

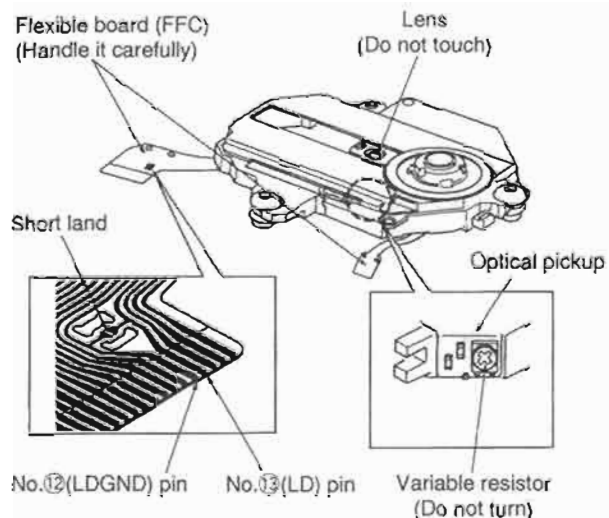

● Grounding for electrostatic breakdown prevention

1. **Human body grounding**
Use the anti-static wrist strap to discharge the static electricity from your body.
2. **Work table grounding**
Put a conductive material (sheet) or steel sheet on the area where the optical pickup is placed, and ground the sheet.

Caution:

The static electricity of your clothes will not be grounded through the wrist strap. So, take care not to let your clothes touch the traverse deck (optical pickup).

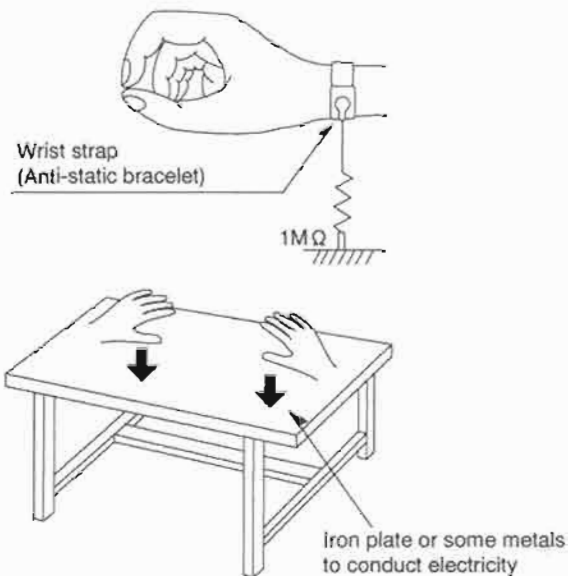

Operation Checks and Main Component Replacement Procedures

- NOTE**
1. This section describes procedures for checking the operation of the major printed circuit boards and replacing the main components.
 2. For reassembly after operation checks or replacement, reverse the respective procedures. Special reassembly procedures are described only when required.
 3. [] indicates parts No.
 4. The pictures show model SL-S650.

1. Checking for the main P.C.B.

(Checking for the main P.C.B. (Component side))

Step 2

Pressing the OPEN button, open the CD cover ass'y.

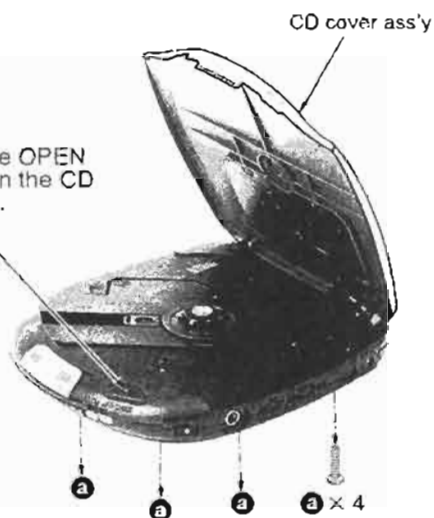

Step 1

Step 3

Open the intermediate cabinet ass'y in the direction of arrow.

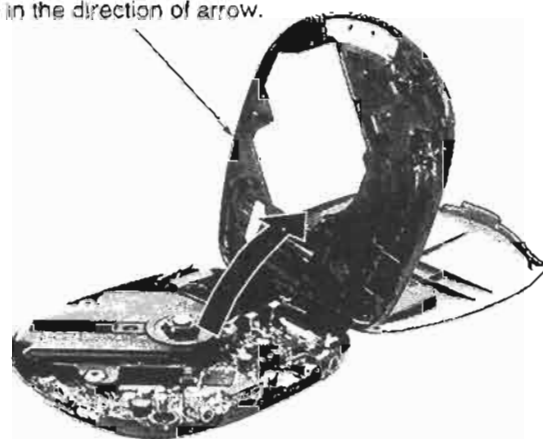

NOTE

- After checking, unsolder the short land to open circuit.
- The tip of screw must not protrude above the floating rubber.
- To keep insulation, place the insulator sheet (paper etc.) between the P.C.B. and the head of screws.

Nut 3mm [XNG3ES]

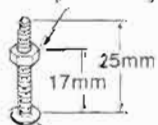

Screw 3mm x 25mm [XSN3+25S]

Nut 3mm [XNG3ES]

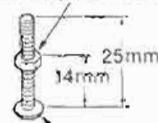

Screw 3mm x 25mm [XSN3+25S]

Step 5

Sustain the traverse deck with the floating rubber inserted screws and nuts as shown above.

Step 4

Short-circuit the land by soldering.



- Check the main P.C.B. (Component side) as shown below.

Step 6

Put the disc (8 cm).

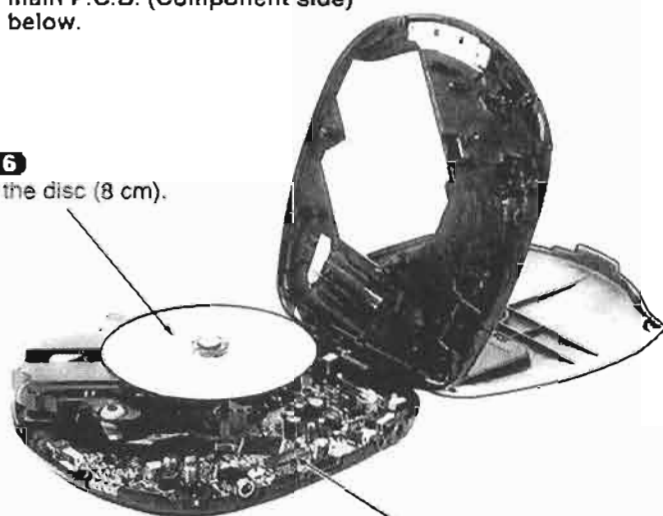

Main P.C.B. (Component side)

NOTE

After checking, unsolder the short land to open circuit.

(Checking for the main P.C.B. (Solder side))

Step 3

Open the intermediate cabinet ass'y in the direction of arrow.

Step 2

Pressing the OPEN button, open the CD cover ass'y.

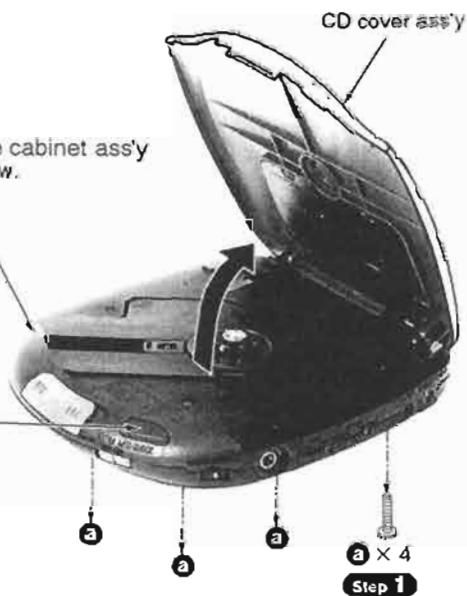
**Step 1****Step 6**

Remove the traverse deck and main P.C.B..

Step 4

Short-circuit the land by soldering.

**Step 5**

Remove the 3 switch knobs.

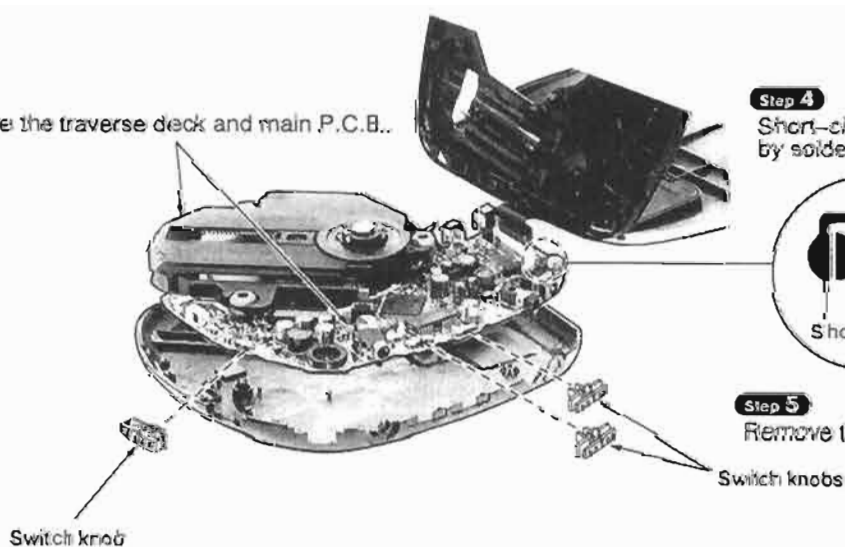

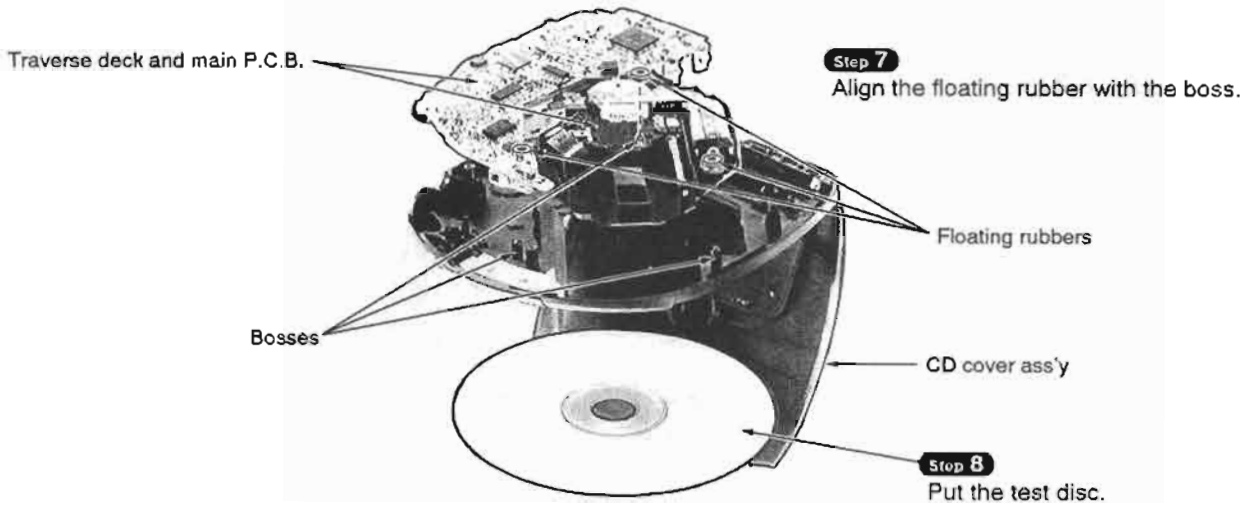

• Check the main P.C.B. (Solder side) as shown below.

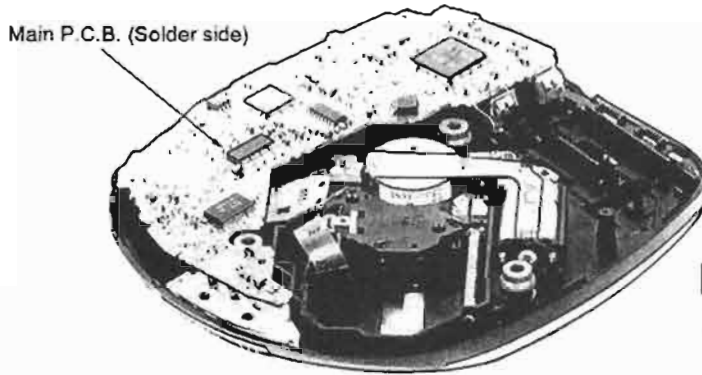

NOTE
After checking, unsolder the short land to open circuit.

Notice for installation of switch knobs

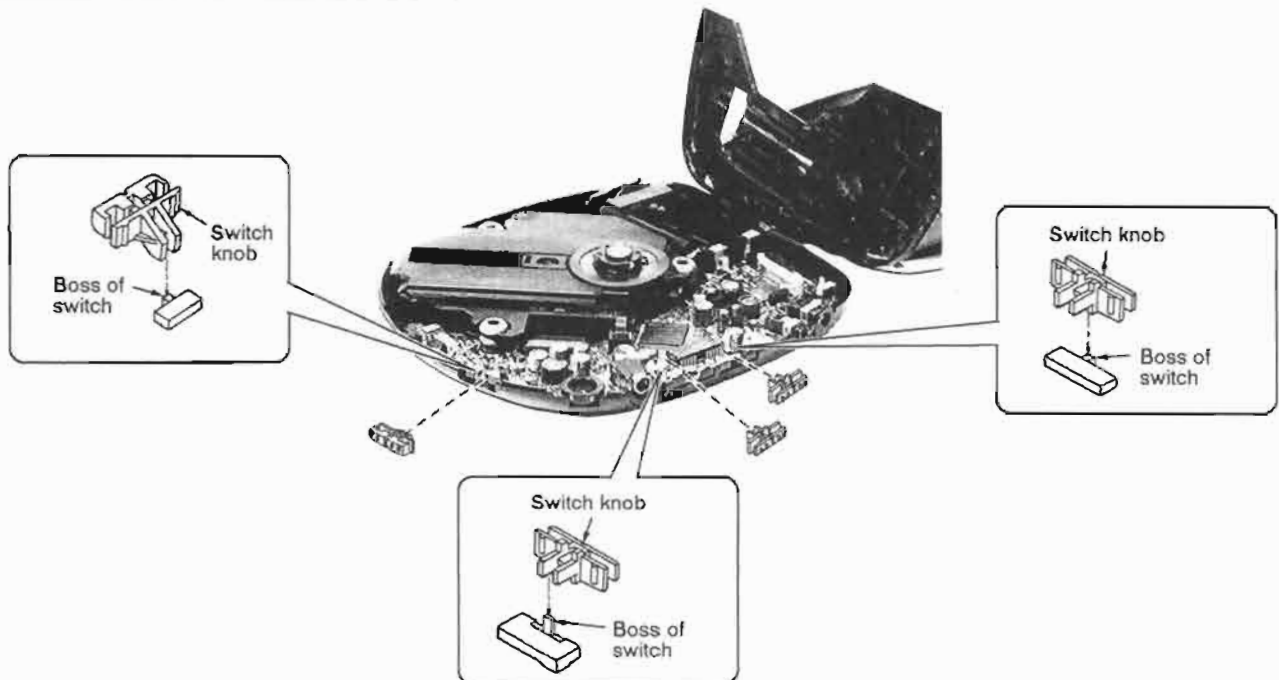

2. Replacement for the traverse deck

Follow the **Step 1** ~ **Step 3** in item 1.

NOTE

Solder the point between pin ⑫ (LD GND) and pin ⑬ (LD) of FFC board.
(Refer to "Handling Precautions for Traverse Deck" on page 12.)

Step 1

Pull out the FFC from connector (CN101).

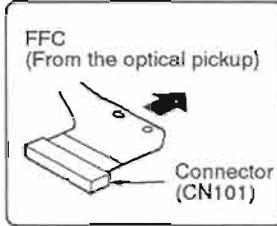

Traverse deck [RAE0142Z]

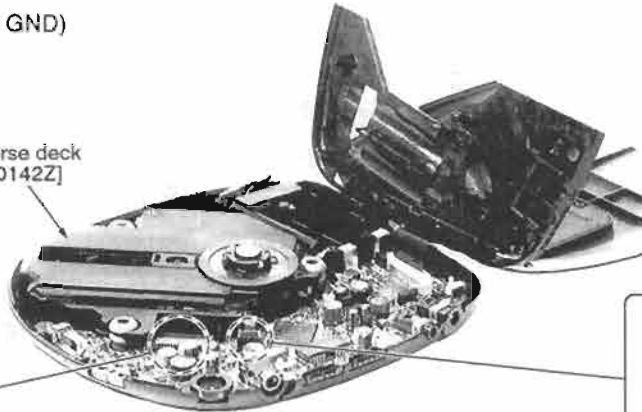

Step 2

Pull out the FFC from connector (CN401).

FFC (From the motors)

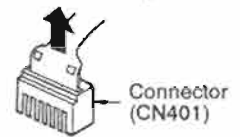

3. Replacement for the LCD

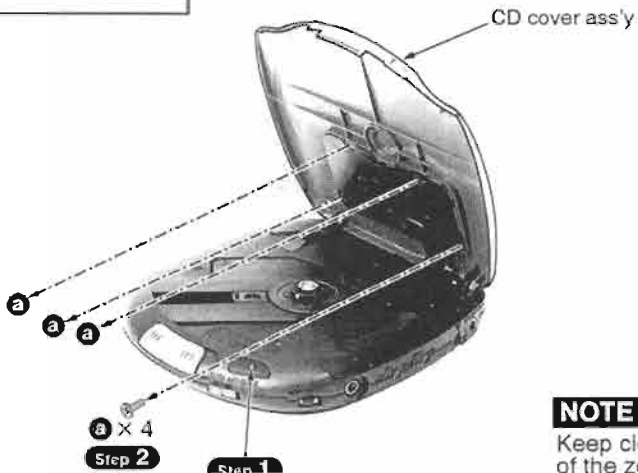

Pressing the OPEN button, open the CD cover ass'y.

NOTE

Keep clean the surface of the zebra rubber.

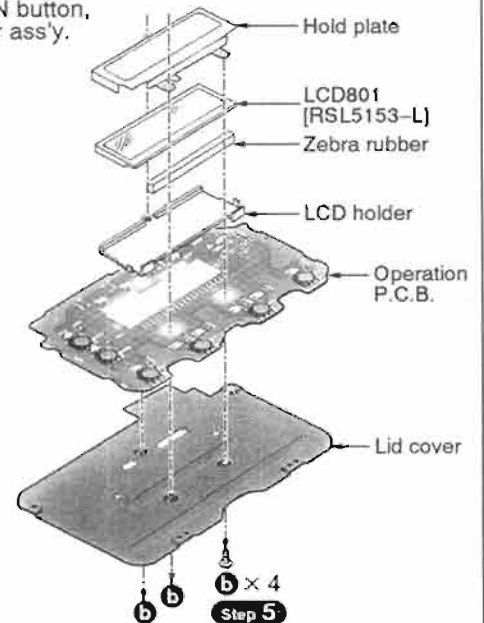

Step 3

Remove the lid cover.



Step 4

Remove the FFC from the connector (CN301).

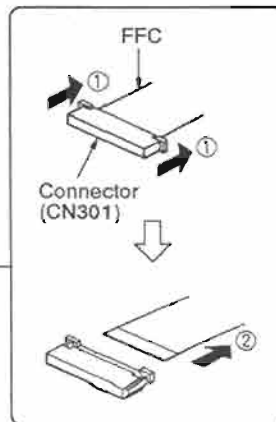

4. Replacement for the CD cover ass'y

• Follow the **Step 1** - **Step 3** in Item 1.



Step 1

Remove the FFC from the connector (CN301).

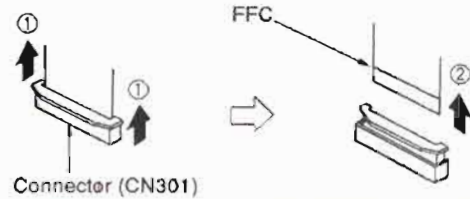

Minus screwdriver

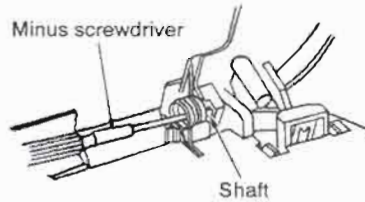

Step 2

Push the shaft with the thin minus screwdriver.

Step 3

Pull out the shaft.

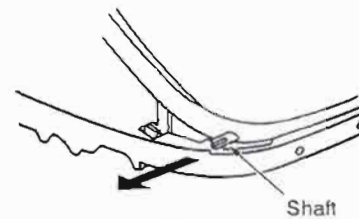

CD cover ass'y
[RFKLLS650P-S : SL-S650]
[RFKLLS651CPS : SL-S651C]

Step 4

Remove the CD cover ass'y from rib.

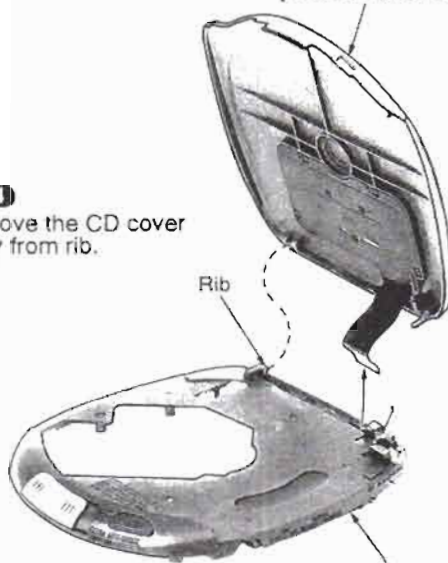

Intermediate cabinet ass'y

Step 5

a × 4

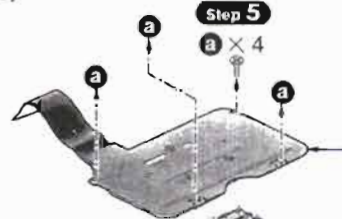

Step 6

Remove the lid cover.

Step 7

Remove the operation button.

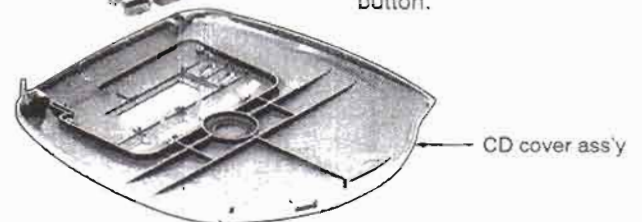

CD cover ass'y

Reassembly procedures of CD cover ass'y

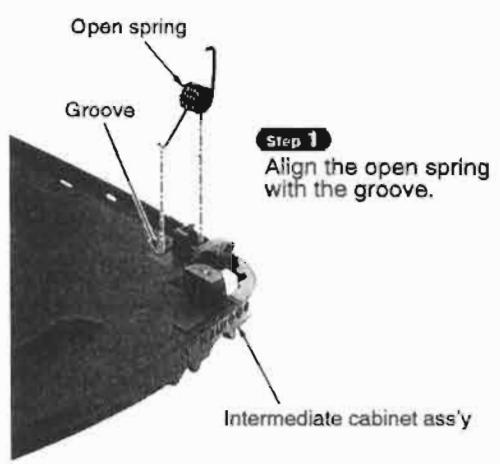

Step 1
Align the open spring with the groove.

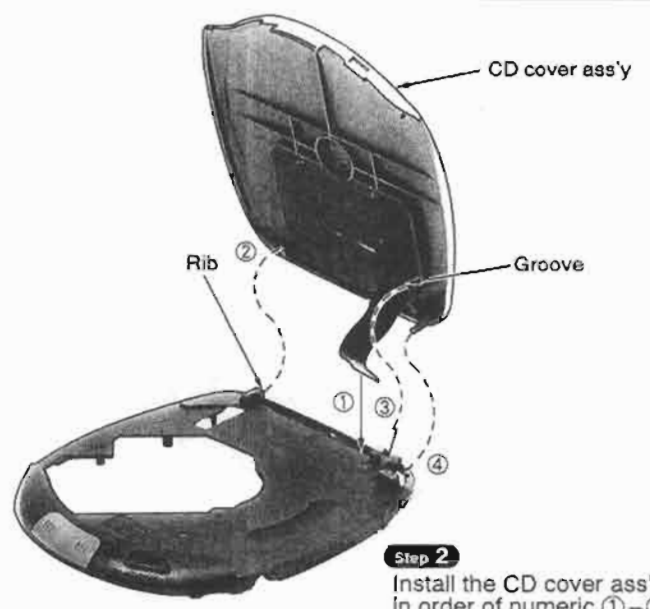

Step 2
Install the CD cover ass'y in order of numeric ①-④.



Step 4
Holding the CD cover ass'y not to be detached the open spring and push the shaft, install the shaft.

■ Checking the Operation Problems on the Traverse Deck (Optical Pickup)

Make sure to follow the procedures below to check the operation problems of the traverse deck (optical pickup) before replacing it. Replace the traverse deck only after the problem is identified.

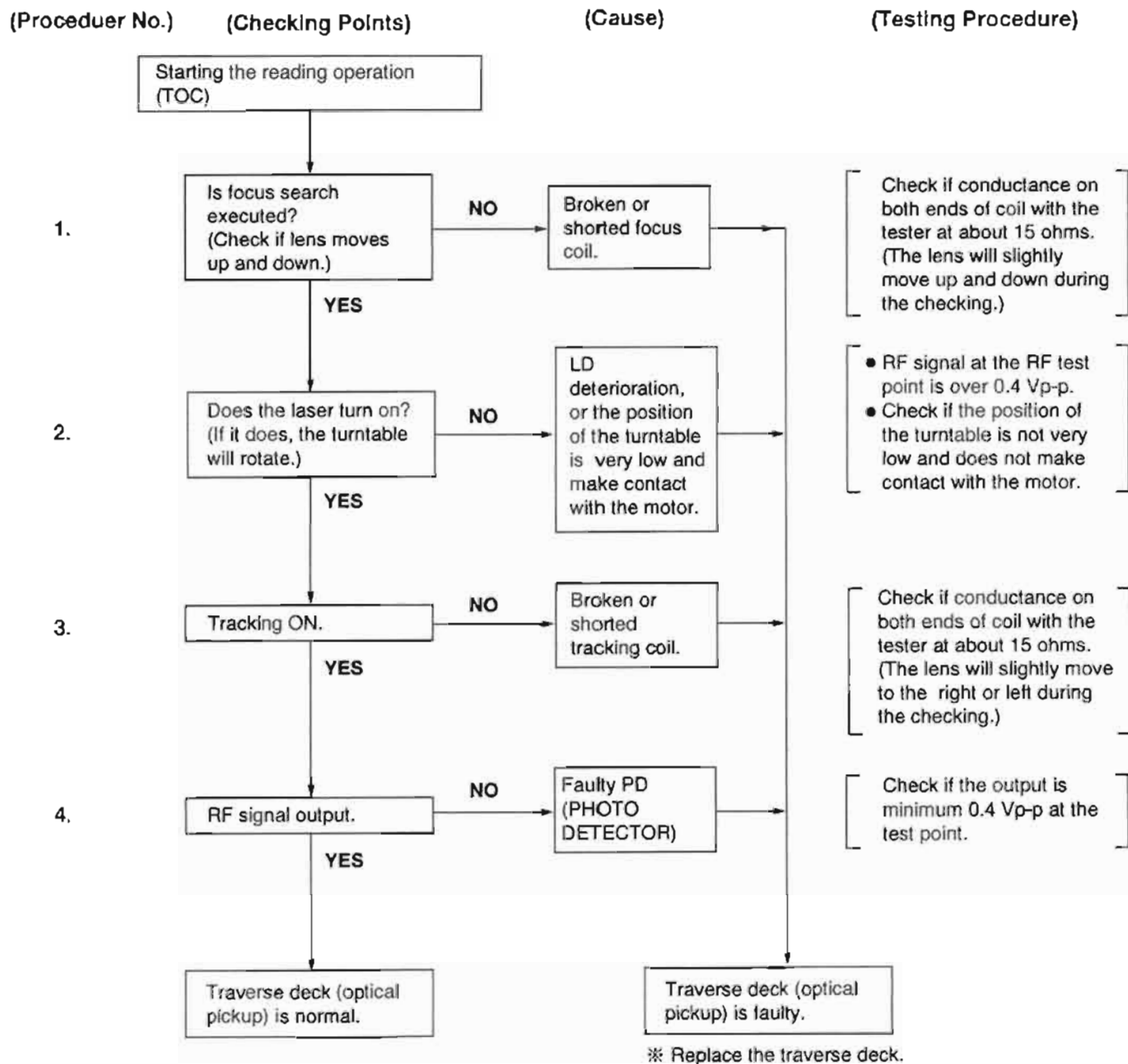

- Check electrical circuit.
- Check for flaws on disc or if it is warped or not centered.

• Check the operations described below on the traverse deck after replacing it.

* Checking Skip Search

1. Play an ordinary musical program disc.
2. Press the skip button to check for normal skip search operation (in both the forward and reverse directions).

* Checking Manual Search

1. Play an ordinary musical program disc.
2. Press the manual search button to check for smooth manual search operations at either low or high speed (in both the forward and reverse directions).

* Checking Playability

1. Play the 0.7 mm black dot and the 0.7 mm wedge on the playability test disc (SZZP1054C) and verify that no sound skip or noise occurs.
2. Play the middle tracks of the uneven test disc (SZZP1056C) and verify that no sound skip or noise occurs.

■ Automatic Adjustment Results Display Function (Self-check Function)

On this unit (SL-S650/S651C), each automatic adjustment result are displayed on the LCD. This function is convenient to check or identify which automatic adjustment circuit is incorrect. The followings are the contents of the automatic adjustment result displays (self-check function).

● How to display automatic adjustment results

1. Load the test disc (SZZP1054C).
2. Press the ◀◀ (SKIP/SEARCH) and ▶▶ (SKIP/SEARCH) Buttons simultaneously and hold them, and additionally press the ▶/⏸ (PLAY/PAUSE) Button.
3. Press the ■ (STOP/POWER OFF) Button once.
4. An automatic adjustment result is displayed on the LCD.

● Display of automatic adjustment results (self-check function)

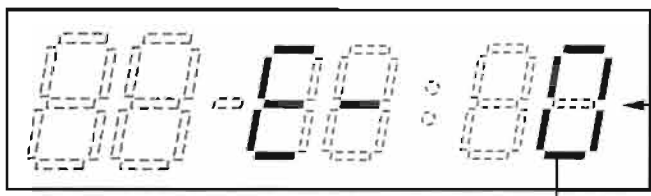

4 bits (TGC, FGC, TBC, FBC) are displayed in hexadecimal system from 0~F.

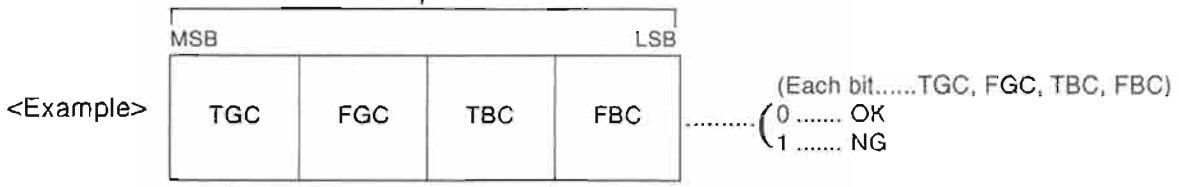

- | | | | | | | | |
|----|-----------|-----------|-----------|-----------|--|---|--|
| 1) | 0 | 0 | 0 | 0 | | ⇒ | “E—0” is displayed.
(All adjustments are OK) Normal |
| 2) | 0
(OK) | 0
(OK) | 0
(OK) | 1
(NG) | | ⇒ | “E—1” is displayed.
(Focus balance adjustment is NG (incorrect).) |
| 3) | 0
(OK) | 1
(NG) | 0
(OK) | 0
(OK) | | ⇒ | “E—4” is displayed.
(Focus gain adjustment is NG.) |
| 4) | 1
(NG) | 1
(NG) | 1
(NG) | 1
(NG) | | ⇒ | “E—F” is displayed.
(All adjustments are NG.) |
| 5) | 1
(NG) | 0
(OK) | 0
(OK) | 0
(OK) | | ⇒ | “E—8” is displayed.
(Tracking gain adjustment is NG.) |

Note: If any other disc than the test disc (SZZP1054C) is used, an “E—8” may be displayed.

(Example) Follow the below steps when "E-1" is displayed.

(Cause: Focus balance (FBC) is set beyond the limit.)

● Check if

- (1) the waveform or voltage of the focus servo circuit is correct.
- (2) the optical pickup returns to the normal state by exchanging the traverse deck.

Follow the below steps when "E-4" is displayed.

(Cause: Focus gain (FGC) is set beyond the limit.)

● Check if

- (1) the waveform or voltage of the focus servo circuit is correct.
- (2) the focus coil of the optical pickup is correct (around 15 ohms).
- (3) the optical pickup returns to the normal state by exchanging the traverse deck.

Follow the below steps when "E-F" is displayed.

(Cause : All adjustments (TGC, FGC, TBC, FBC) are set beyond the limit.)

● Check if

- (1) the optical pickup returns to the normal state by exchanging the traverse deck.
- (2) the waveform or voltage of the servo IC's (IC101, 501) are correct.

Note:

It is not always necessary to exchange the traverse deck when an error message is displayed. Be sure to check if the circuit is defective or not before exchanging the traverse deck.

Note:

If any other disc than the test disc (SZZP1054C) is used, an error message may be displayed. This is not a malfunction.

■ Measurements and Adjustments

Warning: This product uses a laser diode. Refer to caution statements on pages 2, 3.

ACHTUNG: ● Die lasereinheit nicht zerlegen.

- Die lasereinheit darf nur gegen eine vom hersteller spezifizierte einheit ausgetauscht werden.

● Measuring instruments and special tools

● Test discs

1. Playability test disc (SZZP1054C)
2. Uneven test disc (SZZP1056C)

● Musical program disc (ordinary)

- DC voltmeter
- Lead wire (for test points)

● Test short land

Short-circuit the lands of the laser ON/OFF switch (S201) by soldering them. It turns "ON" position. (Refer to below Fig. 1 or printed circuit board and wiring connection diagram for short land location on page 34.)

Note: Remove the solders from the lands after adjustment.

● Adjustment point

Notes: 1. Please refer to the printed circuit board and wiring connection diagram for test point locations on page 34.

2. Take care to connect CN101, CN301 and CN401, as shown in Fig.1.

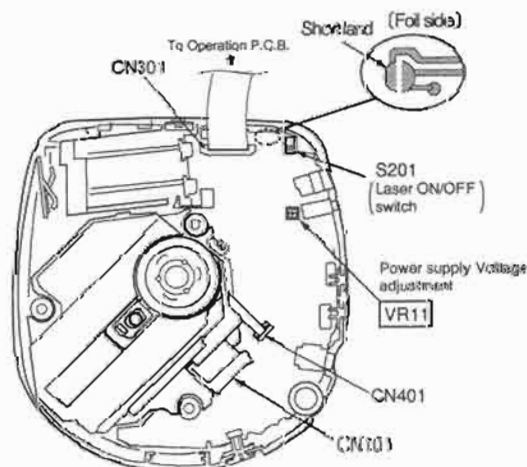

Fig. 1

(1) POWER SUPPLY VOLTAGE ADJUSTMENT

1. Connect the DC voltmeter to **TP103** (VCC) (+) and **TP104** (GND) on the main P.C.B.
2. Connect the AC adaptor cord to the DC (IN) port and move the PLAY switch to the ON position.
(Use a new dry cell battery or a rechargeable battery that is full charged.)
3. Insert the test disc, and switch the player power ON.
4. Adjust **VR11** on the main P.C.B. at 2.70 ± 0.02 V, as shown in Fig. 1.

(2) CHECK OF PLAY OPERATION*** Checking Skip Search**

1. Play an ordinary musical program disc.
2. Press the skip button to check for normal skip search operation (in both the forward and backward directions).

*** Checking Manual Search**

1. Play an ordinary musical program disc.
2. Press the manual search button to check for smooth manual search operations at either low or high speed (in both the forward and backward directions).

*** Checking Playability**

1. Play the 0.7 mm black dot and the 0.7 mm wedge on the playability test disc (SZZP1054C) and verify that no sound skip or noise occurs.
2. Play the middle tracks of the uneven test disc (SZZP1056C) and verify that no sound skip or noise occurs.

• Automatic adjustment

On our conventional type portable CD player, there were mounted 6 semi-fixed controls for each adjustment. Since the SL-S650/S651C servo circuit is equipped with an automatic adjusting circuit, these controls are removed from SL-S650/S651C.

On conventional portable CD player

Use for Old Servo IC (AN8373SE2, AN8374SE2)

On SL-S650/S651C

Use for New Servo IC (AN8837SBE1, MN662745RPC)

- | | | | |
|---|--------------------------|---|-----------------------------|
| 1. Tracking Offset Adjustment VR (TOC) | <input type="checkbox"/> | ➔ | Non Adjustment |
| 2. Focus Offset Adjustment VR (FOC) | <input type="checkbox"/> | | |
| 3. Tracking Gain Adjustment VR (TGC) | <input type="checkbox"/> | | |
| 4. Focus Gain Adjustment VR (FGC) | <input type="checkbox"/> | | |
| 5. Tracking Balance Adjustment VR (TBC) | <input type="checkbox"/> | ➔ | Automatic Adjusting Circuit |
| 6. Focus Balance Adjustment VR (FBC) | <input type="checkbox"/> | | |

Total 6 Adjustment VRs

➔ No Adjustment VR

Although all discs are manufactured according to the same specifications, their characteristics are not always precisely the same because they are produced by different manufacturers in various lots, or have different warp etc.

SL-S650/S651C automatically controls the servo circuit to obtain optimum performance according to any disc's characteristics. Therefore, no malfunction occurs because of mis-adjustment.

Outline of 10 - Second Sound Keeper Technique Used for Prevention of Sound from Skipping

1. Conventional Shockproofing Technique

Input information read out of the CD at double speed is demodulated, stored in the memory, and while sound-marking signal is supplied at normal speed from the memory to the D/A converter, the residual data is accumulated in the memory.

If reaccess to the break point is accomplished before the memory becomes empty, apparent playback sound is entirely kept free from breaking even when information pauses due to vibration, etc. It was necessary to use the 4M bit memory for securing the accumulation time of about 3 seconds.

2. Compression-shockproofing [Outline]

Fig. 1 is a block diagram showing the compression-shockproofing mechanism, the difference of which from the conventional mechanism is as follows: Input information read out at double speed undergoes data compression (16 bits → 4 bits) by the encoder in the ADPCM (Adaptive Difference PCM) and stored in the external memory; the stored memory information undergoes data elongation (4 bits → 16 bits) by the decoder in the ADPCM and supplied at normal speed to the D/A converter.

The data compression technique has conducted to reduction of required memory capacity from 4M bits to 1M bit for securing the accumulation time equivalent to the conventional.

All-inclusive Block Diagram

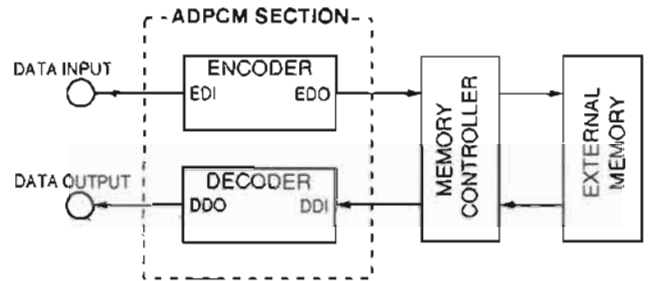
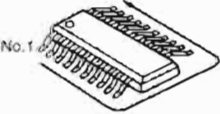
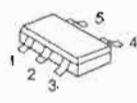
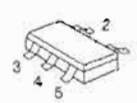
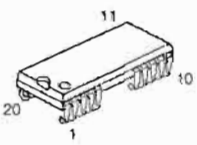
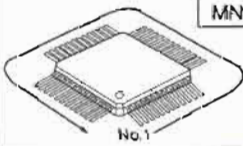
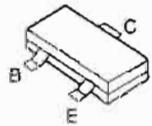
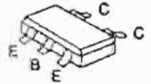
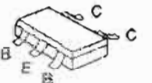

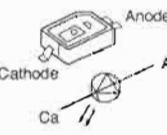
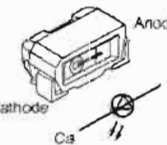
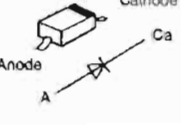
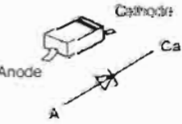
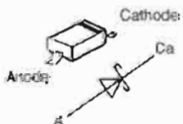
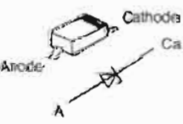
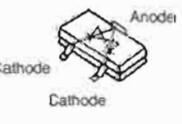
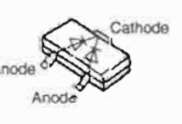
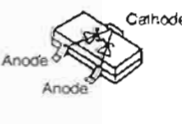
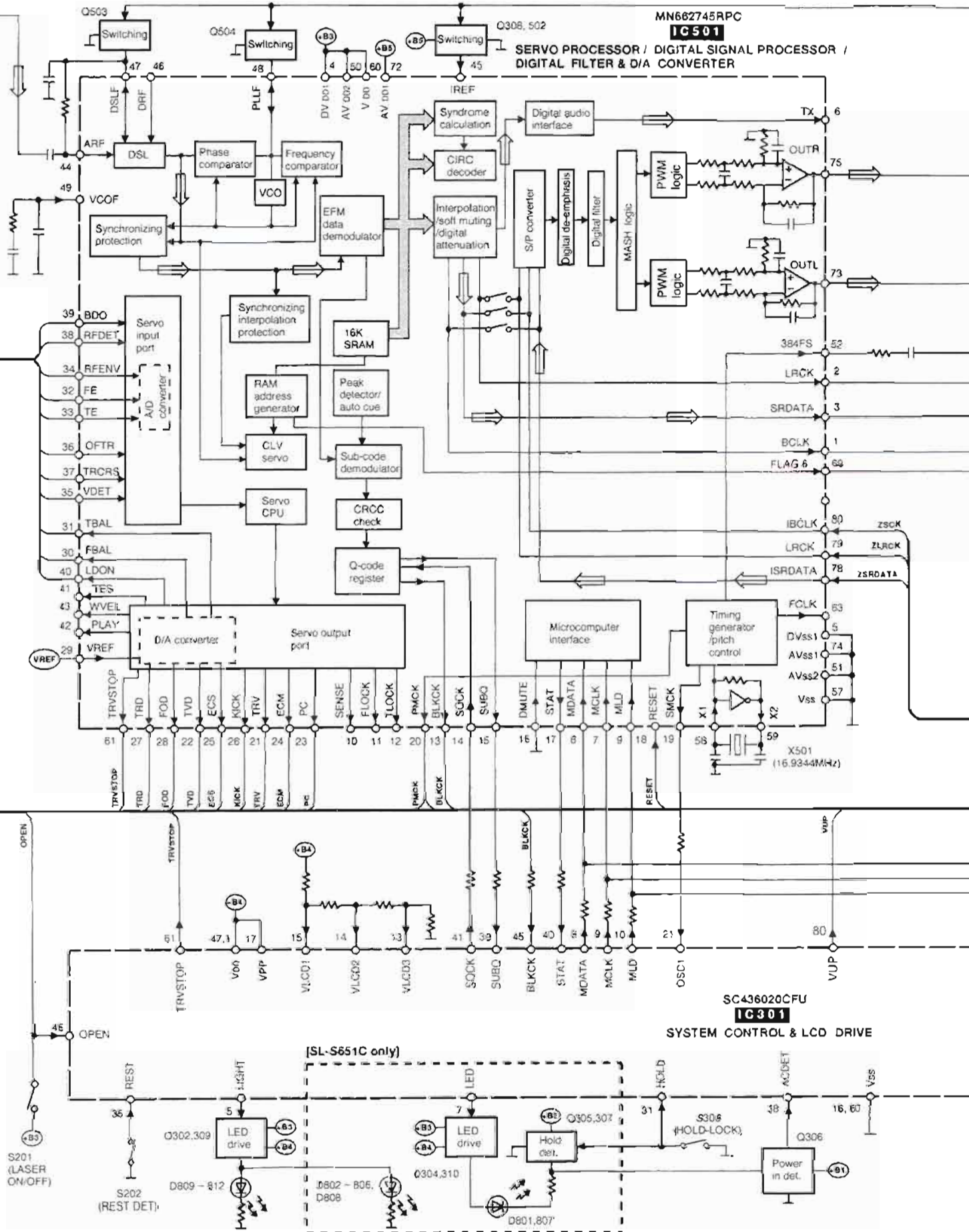

Fig.1

Type Illustration of IC's, Transistors and Diodes

 <table border="1" data-bbox="400 1036 642 1160"> <tr><td>NJU7082AMTE1</td><td>8 Pin</td></tr> <tr><td>AN8086SE2</td><td>16 Pin</td></tr> <tr><td>AN8837SBE1</td><td>28 Pin</td></tr> <tr><td>MPC17A50VMEL</td><td>36 Pin</td></tr> </table>	NJU7082AMTE1	8 Pin	AN8086SE2	16 Pin	AN8837SBE1	28 Pin	MPC17A50VMEL	36 Pin	<p>TC7S86FTE85L</p> 	<p>NJM2406FTE1</p> 	<p>M44400CJ7E2</p> 
NJU7082AMTE1	8 Pin										
AN8086SE2	16 Pin										
AN8837SBE1	28 Pin										
MPC17A50VMEL	36 Pin										
<table border="1" data-bbox="241 1222 476 1315"> <tr><td>SM5859AF</td><td>44 Pin</td></tr> <tr><td>SC436020CFU</td><td>80 Pin</td></tr> <tr><td>MN662745RPC</td><td>80 Pin</td></tr> </table> 	SM5859AF	44 Pin	SC436020CFU	80 Pin	MN662745RPC	80 Pin		<p>2SB1218QRSTX 2SB709QRSTX 2SB970RSTX 2SD1328STTX 2SD1328RSTTX 2SD1758TLPQR 2SD1819QRSTX DTA114YUA106</p>	<p>DTA143TUT106 UN5113TX UN5115TX UN5210TX UN5211TX UN5213TX UN5215TX UN521VTX</p>	<p>XN2401TX</p> 	
SM5859AF	44 Pin										
SC436020CFU	80 Pin										
MN662745RPC	80 Pin										
<p>XN1210TX XN1213TX XN1215TX XN1501TX XP0121N00L</p> 	<p>2SD1450STTA</p> 	<p>2SD2074HWSTT</p> 	<p>LN1371GH6UTR</p> 	<p>LNJ310M6URA</p> 	<p>MA110TX</p> 						
<p>MA8033LTX</p> 	<p>MA8047MTX</p> 	<p>MA8082MTX</p> 	<p>MA142WATX</p> 	<p>MA141WKTX</p> 	<p>RB411DT146</p> 						

• Signal line ⇨ : Audio signal



● Signal line ⇨ : Audio signal

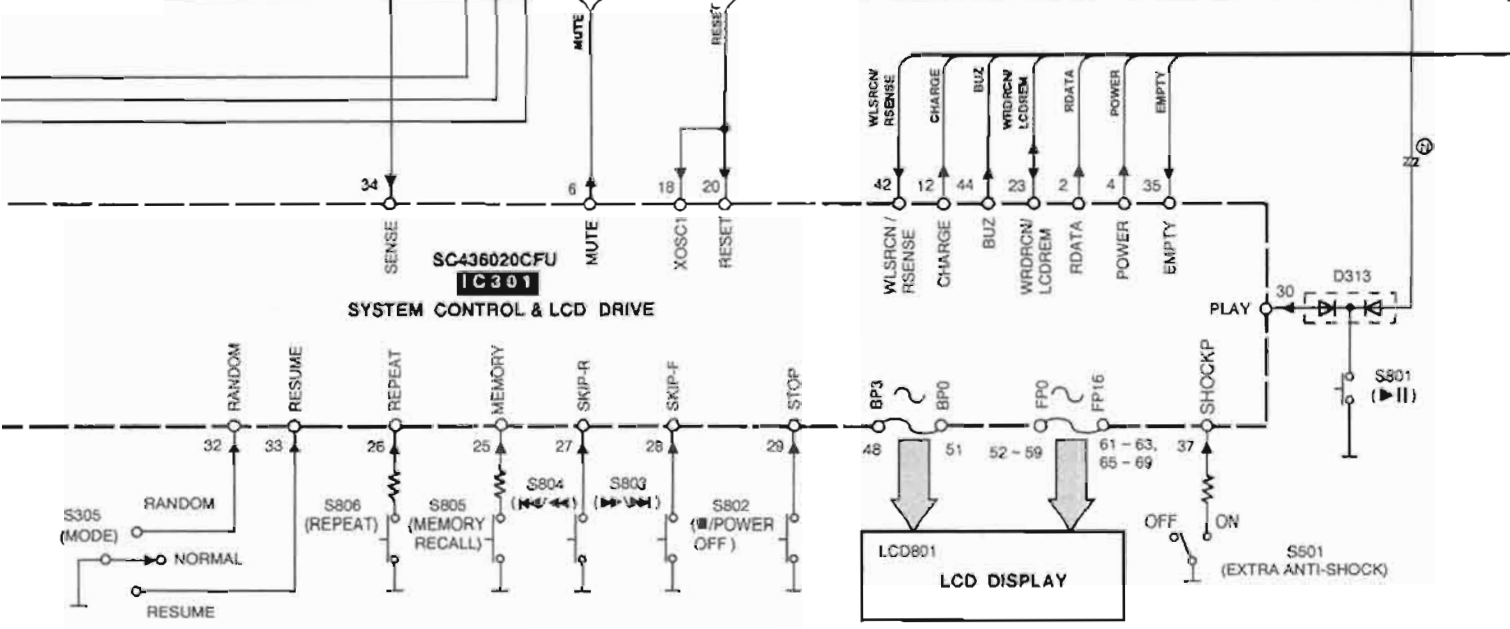
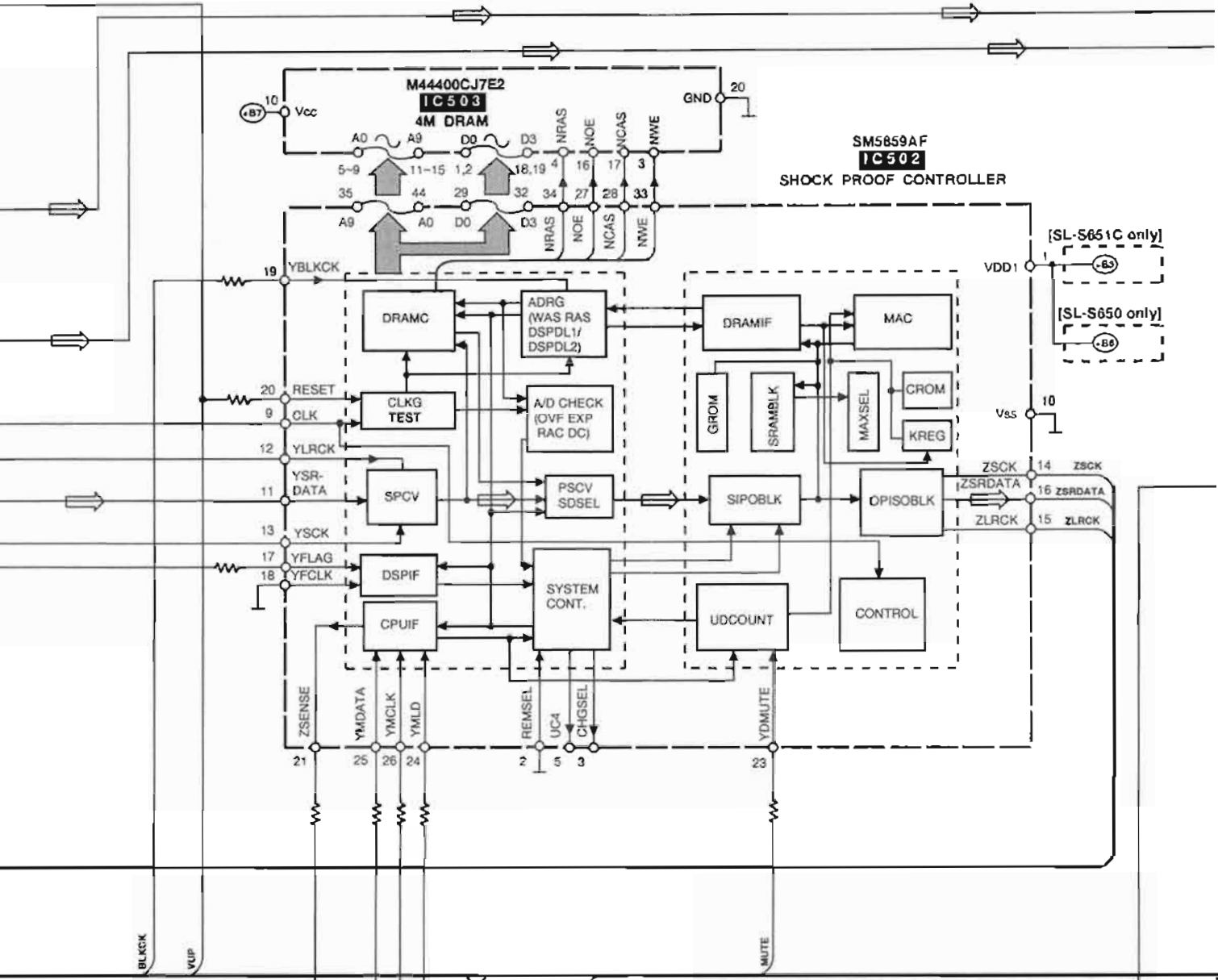

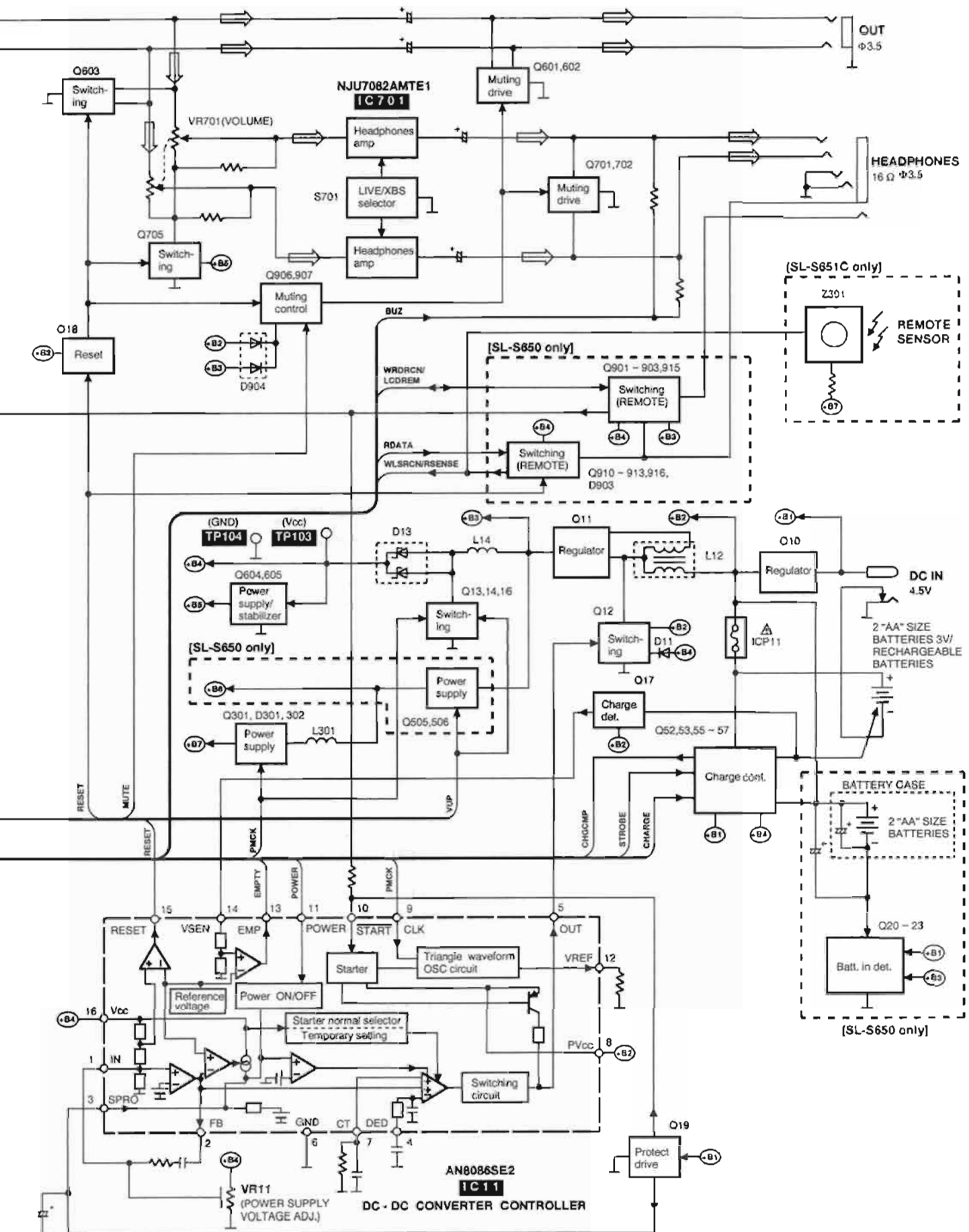



■ Schematic Diagram (See parts list on pages 41, 42, 44, 45.)

(This schematic diagram may be modified at any time with the development of new technology.)

Notes:

- S201: Laser ON/OFF switch in "OFF" position.
(It turns "ON" with disc holder closed.)
- S202: Rest detector in "OFF" position.
(It turns "ON" when optical pickup comes to innermost periphery.)
- S305: Play mode selector (MODE) in "RANDOM" position.
(RANDOM ⇄ NORMAL ⇄ RESUME)
- S306: Hold (HOLD-LOCK) switch in "OFF" position.
- S501: Extra anti-shock (EXTRA ANTI-SHOCK) switch in "ON" position.
- S701: LIVE/XBS switch in "OFF" position.
(LIVE ⇄ XBS ⇄ OFF)
- S801: Play/pause (▶ / ||) switch.
- S802: Stop/power off (■/POWER OFF) switch.
- S803: Skip/search (▶▶ / ▶▶ , ◀◀ / ◀◀) switches.
S804: [S804: GO BACK, S803: ADVANCE]
- S805: Memory/recall (MEMORY/RECALL) switch.
- S806: Repeat (REPEAT) switch.
- VR11: Power supply voltage adjustment.
- VR701: Headphones volume (VOLUME) control.
- The voltage value and waveforms are the reference voltage of this measured by DC electronic voltmeter (high impedance) and oscilloscope on the basis of GND terminal (DC IN Jack).
Accordingly, there may arise some errors in the voltage values and waveforms depending upon the internal impedance of the tester or measuring unit.
- Measurement conditions
 - * Set the hold and extra anti-shock switches to ON.
 - * The parenthesized is the voltage for test disc (1 kHz, L + R, 0 dB) in play mode, and the other, for no disc in stop mode.
 - * AC adaptor is used for power supply.
- : Positive voltage lines.
- : Audio signal lines.
- Important safety notice:
Components identified by Δ mark have special characteristics important for safety. Furthermore, special parts which have purposes of fire-retardant (resistors), high-quality sound (capacitors), low-noise (resistors), etc. are used. When replacing any of components, be sure to use only manufacturer's specified parts shown in the parts list.

Caution!

IC and LSI are sensitive to static electricity. Secondary trouble can be prevented by taking care during repair.

- Cover the parts boxes and plastics with aluminum foil.
- Ground the soldering iron.
- Put a conductive mat on the work table.
- Do not touch the pins of IC or LSI with fingers directly.

A OPERATION CIRCUIT (P.C Board: on page 34)

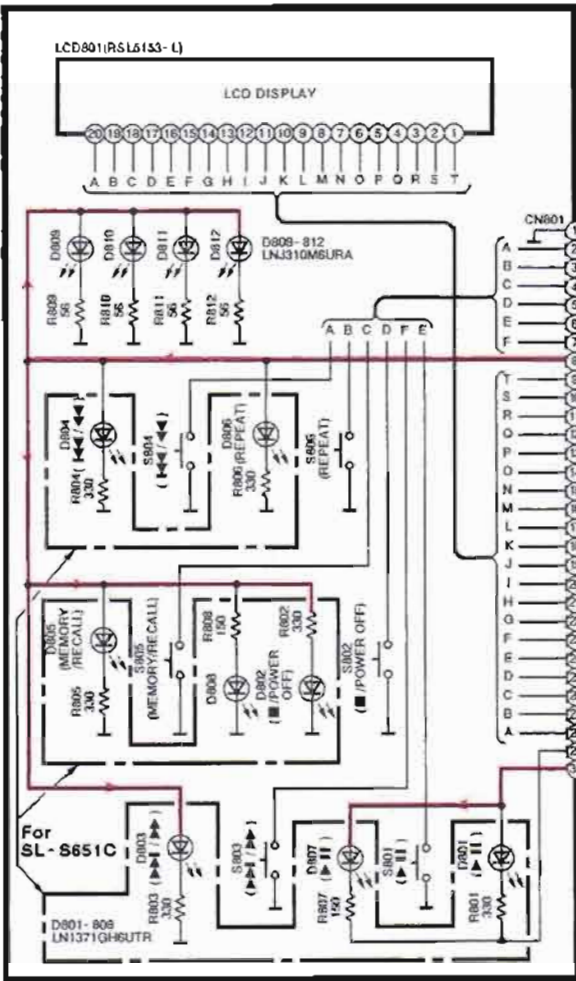

Δ OPTICAL PICKUP CIRCUIT

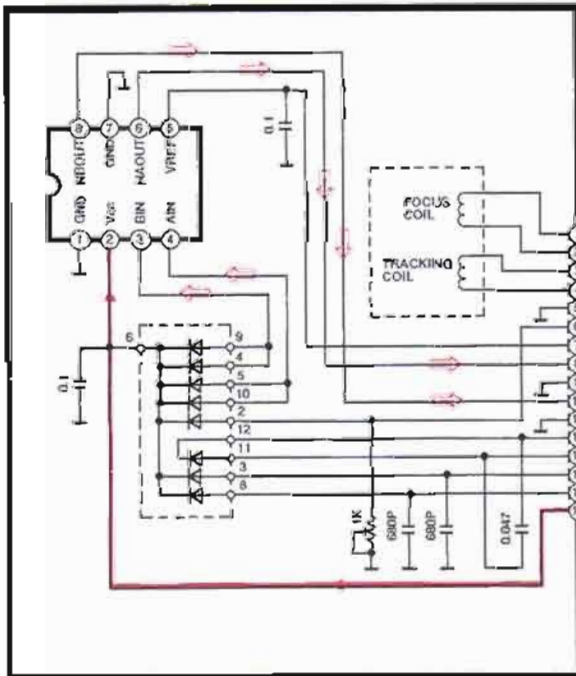

B MAIN CIRCUIT (P.C. Board: on pages 34,35)

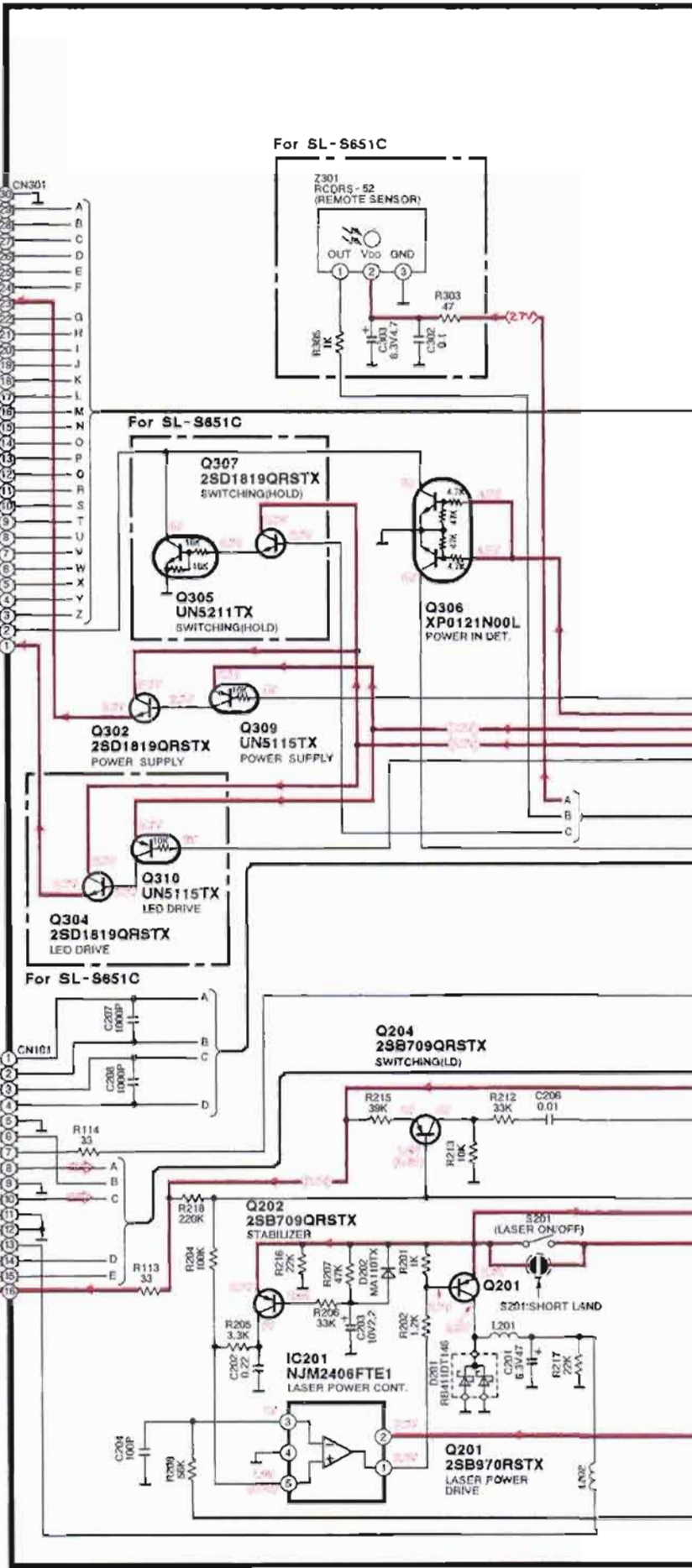

Note: ● → : Audio signal lines.

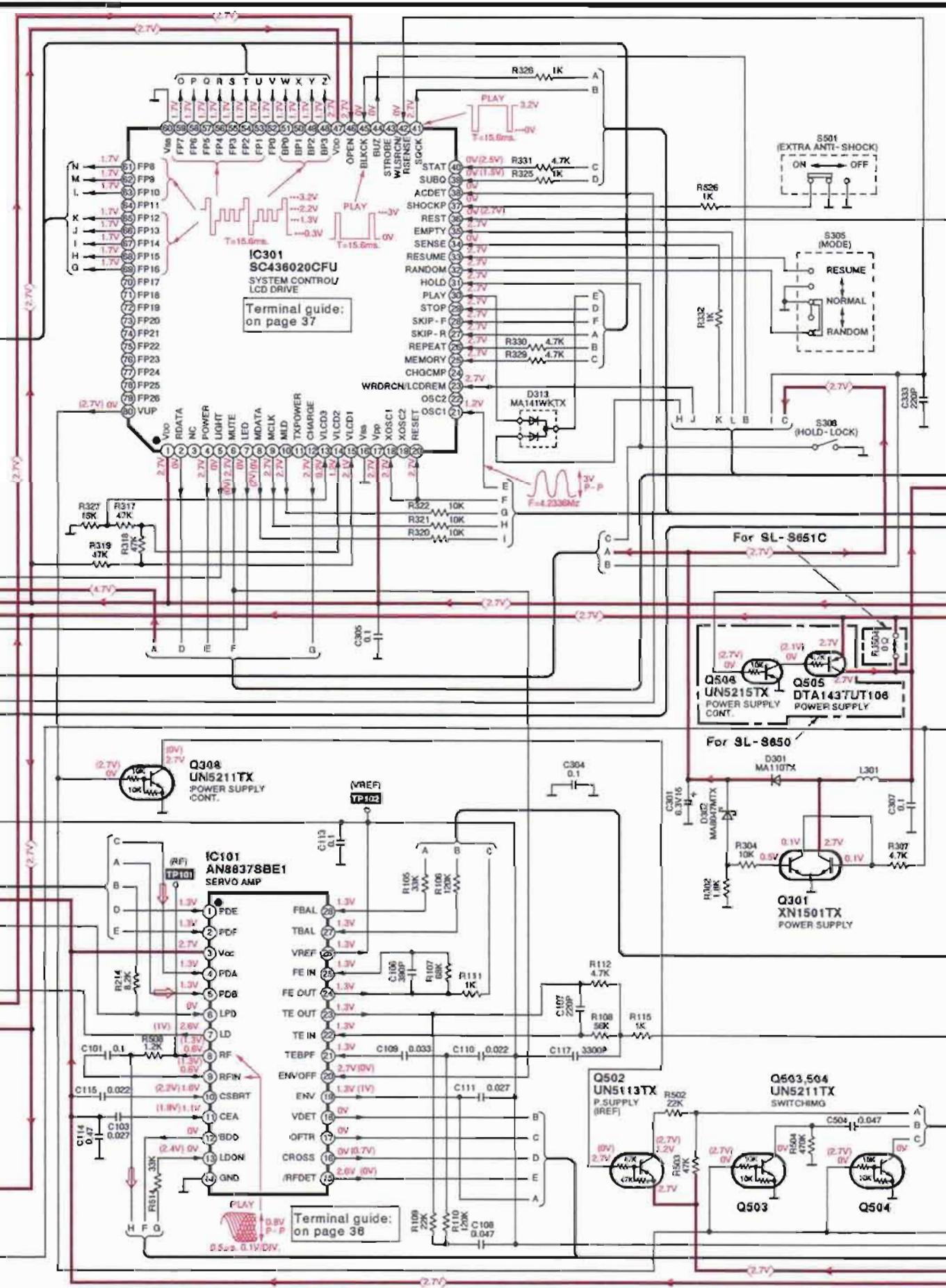

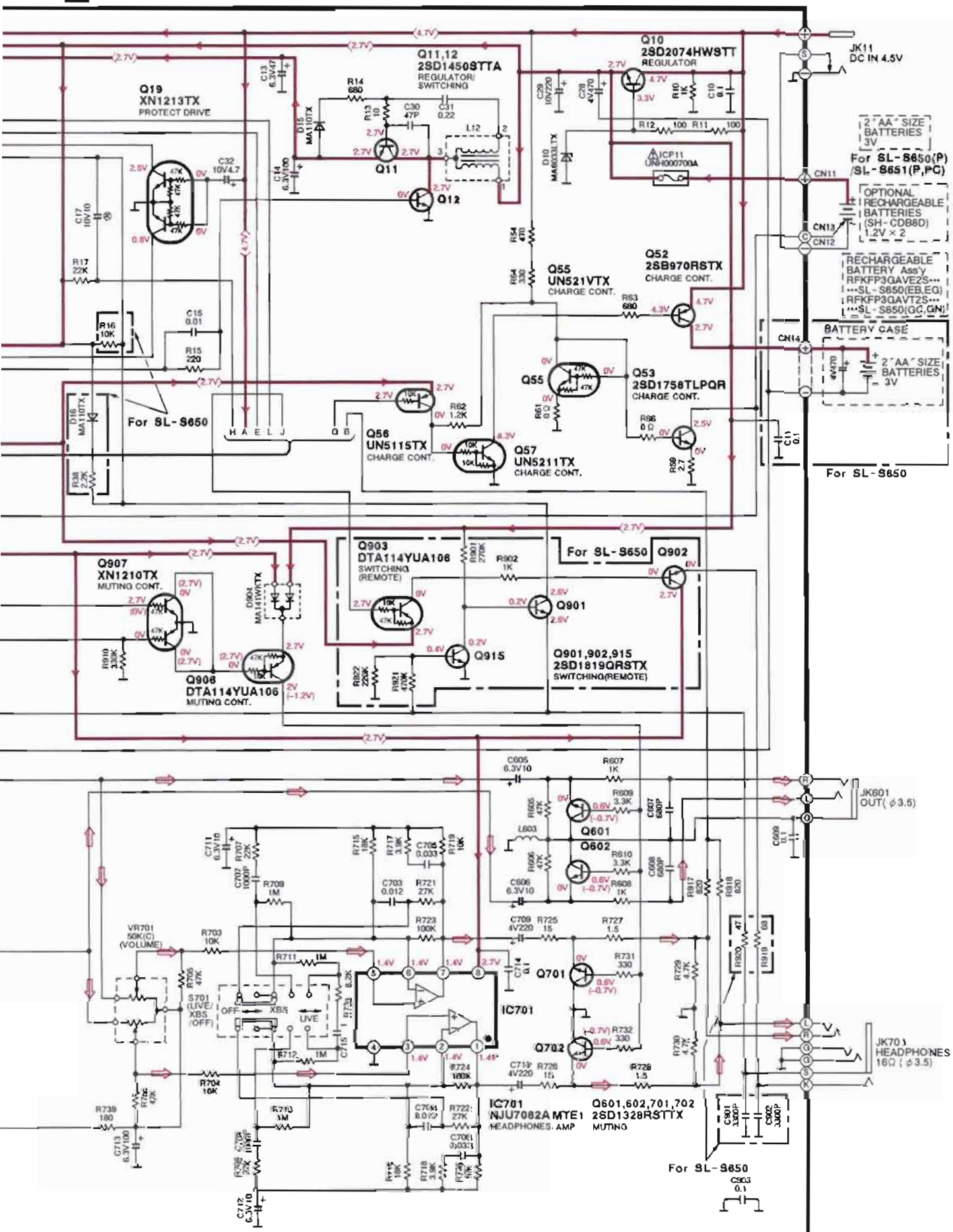
B MAIN CIRCUIT (P.C. Board: on pages 34,35)

■ Terminal Function of IC's

● IC11 (AN8086SE2) : DC-DC converter controller

Pin No.	Mark	I/O Division	Function
1	IN	I	Error amp input
2	FB	O	Error amp output
3	SPRO	I	Short protect circuit
4	DED	I	Dead time input
5	OUT	O	Switching output
6	GND	—	GND terminal
7	CT	I	Triangular wave oscillator capacitor input
8	PVcc	I	Power supply terminal

Pin No.	Mark	I/O Division	Function
9	CLK	I	Clock signal input (f=88.2kHz)
10	START	I	Start detection input
11	POWER	I	Power ON/OFF detection terminal
12	VREF	O	Reference voltage input
13	EMP	O	Empty signal output
14	VSEN	I	Empty detect terminal
15	RESET	O	Reset signal output
16	Vcc	I	Power supply terminal

● IC101 (AN8837SBE1): Servo amp.

Pin No.	Mark	I/O Division	Function
1	PDE	I	Tracking signal input terminal (1)
2	PDF	I	Tracking signal input terminal (2)
3	Vcc	I	Power supply terminal
4	PDA	I	Focus signal input terminal (1)
5	PDB	I	Focus signal input terminal (2)
6	LPD	I	APC amp input terminal
7	LD	O	APC amp output terminal
8	RF	O	RF summing output terminal
9	RF IN	I	RF signal input terminal
10	CSBRT	I	Capacitor connection terminal for OFTR
11	CEA	I	Capacitor connection terminal for H.P.F. amp
12	BDO	O	Dropout signal output terminal ("H" : Dropout)
13	LDON	I	APC control input terminal
14	GND	—	GND terminal

Pin No.	Mark	I/O Division	Function
15	/RFDET	O	RF det. signal output terminal ("L" : Det.)
16	CROSS	O	Track cross signal output terminal
17	OFTR	O	Off track signal output terminal ("H" : Off track)
18	VDET	O	Vibration det. signal output terminal ("H" : Det.)
19	ENV	O	RF envelope signal output terminal
20	ENV OFF	I	ENV control input terminal
21	TEBPF	I	VDET input terminal
22	TE IN	I	Tracking error amp input terminal
23	TE OUT	O	Tracking error amp output terminal
24	FE OUT	O	Focus error amp output terminal
25	FE IN	I	Focus error amp input terminal
26	VREF	O	Reference voltage output terminal
27	TBAL	I	Tracking balance signal input terminal
28	FBAL	I	Focus balance signal input terminal

● IC301 (SC436020CFU) : System control & LCD drive

Pin No.	Mark	I/O Division	Function
1	VDD	I	Power supply terminal
2	RDATA	O	Key scan signal output
3	NC	—	Not connected
4	POWER	O	Power ON/OFF signal output
5	LIGHT	O	LCD backlight control signal output
6	MUTE	O	Muting signal output ("H" : MUTE)
7	LED	O	LED drive command signal (Not used, open)
8	MDATA	O	Command data signal output
9	MCLK	O	Command clock output
10	MLD	O	Command load signal output
11	TX POWER	O	Voltage control terminal (Not used, open)
12	CHARGE	O	Not used, open
13	VLCD3	I	Power supply terminal (LCD drive)
14	VLCD2		
15	VLCD1		
16	VSS	—	GND terminal
17	VPP	I	Power supply terminal
18	XOSC1	I	Reset signal input terminal
19	XOSC2	—	Not used, open
20	RESET	I	Reset detect terminal
21	OSC1	I	Main-system clock input
22	OSC2	—	Not used, open
23	WRDRCN/ LCDREM	I/O	Remote control signal output
24	CHGCMP	O	Remote control signal output (Not used, open)
25	MEMORY	I	Key input terminal (MEMORY/RECALL)
26	REPEAT	I	Key input terminal (REPEAT)
27	SKIP-R	I	Key input terminal (SKIP. R)
28	SKIP-F	I	Key input terminal (SKIP. F)
29	STOP	I	Key input terminal (■ / POWER OFF)

Pin No.	Mark	I/O Division	Function
30	PLAY	I	Key input terminal (PLAY/PAUSE)
31	HOLD	I	Key input terminal (HOLD)
32	RANDOM	I	Play mode (RANDOM) selector terminal
33	RESUME	I	Play mode (RESUME) selector terminal
34	SENSE	I	Sense signal input
35	EMPTY	I	Empty detection input terminal
36	REST	I	Reset detection terminal
37	SHOCKP	I	X-DSSP/OPT OUT ON/OFF selector terminal
38	ACDET	I	Power supply detection signal input
39	SUBQ	I	Sub-code (Q data) input
40	STAT	I	Status signal (CRC, CUE, CLVS, TTSTOP, FCLV, SQCK) input
41	SQCK	O	Sub-code Q resistor clock output
42	WLSRCN/ RSENSE	I	Remote control signal input
43	STROBE	I/O	Rechargeable control input/output terminal (Not used, open)
44	BUZ	O	Beep control output
45	BLKCK	I	Sub-code block (Q data) clock (75Hz) input
46	OPEN	I	Disc holder OPEN det. terminal (Not used, connected to power supply)
47	VDD	I	Power supply terminal
48 } 51	BP3 } BP0	O	LCD segment signal output
52 } 59	FP0 } FP7	O	LCD segment signal output
60	VSS	—	GND terminal
61 } 69	FP8 } FP16	O	LCD segment signal output
70 } 79	FP17 } FP26	—	LCD segment signal output (Not used, open)
80	VUP	O	Loop filter control output terminal

● IC401 (MPC17A50VMEL) : Motor drive

Pin No.	Mark	I/O Division	Function
1	CGND	—	GND terminal (control circuit)
2	VLG	I	Power supply terminal (control circuit)
3	INTR	I	Tracking coil control signal input
4	NI2	—	Connected to capacitor filter
5	OP2		
6	INFO	I	Focus coil control signal input
7	NI1	—	Connected to capacitor filter
8	OP1		
9	LIM	I	Limit control level signal input
10	VR	I	Voltage control terminal
11	CLK	I	Clock signal input
12	OP3	—	Connected to capacitor filter
13	NI3		
14	INTV	I	Traverse motor control signal input
15	OP4	—	Connected to capacitor filter
16	NI4		
17	INSP	I	Spindle motor control signal input
18	PHSW	I	CH4 mode input terminal
19	POL	O	CH4 monitor output terminal (Not used, open)

Pin No.	Mark	I/O Division	Function
20	CFL4	—	Connected to capacitor filter
21	CFL3		
22	SP+	O	Spindle motor drive signal output
23	SP-		
24	PVcc	I	(CH3, CH4 output) Power supply terminal
25	TRV-	O	Traverse motor drive signal output
26	PGND	—	GND terminal (CH3, CH4 output)
27	TRV+	O	Traverse motor drive signal output
28	FO+	O	Focus coil drive signal output
29	PGND	—	GND terminal (CH1, CH2 output)
30	FO-	O	Focus coil drive signal output
31	PVcc	I	(CH1, CH2 output) Power supply terminal
32	TR-	O	Tracking coil drive signal output
33	TR+		
34	CFL1	—	Connected to capacitor filter
35	CFL2		
36	VG	I	Power supply terminal (Print driver circuit)

● IC501 (MN662745RPC) : Servo processor/digital signal processor/digital filter/D/A converter

Pin No.	Mark	I/O Division	Function
1	BCLK	O	Serial bit clock output
2	LRCK	O	L/R discriminating signal output
3	SRDATA	O	Serial data signal output
4	DVDD1	I	Power supply (digital circuit) terminal
5	DVSS1	—	GND (digital circuit) terminal
6	TX	O	Digital audio interface signal (Not used, open)
7	MCLK	I	Command clock signal
8	MDATA	I	Command data signal
9	MLD	I	Command load signal ("L" : LOAD)
10	SENSE	O	Sense signal (OFT, FESL, NACEND, NAJEND, POSAD, SFG) (Not used, open)
11	FLOCK	O	Optical servo condition (focus) ("L" : lead-in) (Not used, open)
12	TLOCK	O	Optical servo condition (tracking) ("L" : lead-in) (Not used, open)

Pin No.	Mark	I/O Division	Function
13	BLKCK	O	Sub-code block clock (f=75Hz)
14	SQCK	I	Sub-code Q register clock
15	SUBQ	O	Sub-code Q code
16	DMUTE	I	Muting input ("H" : MUTE) (Not used, connected to GND)
17	STAT	O	Status signal (CRC, CUE, CLVS, TTSTOP, FCLV, SQCK)
18	RESET	I	Reset signal ("L" : reset)
19	SMCK	O	System clock (f=4.2336MHz)
20	PMCK	O	Frequency division clock signal (f=1/1.92×ck=88.2kHz)
21	TRV	O	Traverse servo control
22	TVD	O	Traverse drive signal
23	PC	O	Spindle motor drive signal ("L" : ON)
24	ECM	O	Spindle motor drive signal (Forced mode)
25	ECS	O	Spindle motor drive signal (Servo error signal)

Pin No.	Mark	I/O Division	Function
26	KICK	O	Kick pulse output
27	TRD	O	Tracking drive signal output
28	FOD	O	Focus drive signal output
29	VREF	I	D/A drive output (TVD, ECS, TRD, FOD, FBAL, TBAL) normal voltage input terminal
30	FBAL	O	Focus balance adj. output
31	TBAL	O	Tracking balance adj. output
32	FE	I	Focus error signal (analog input)
33	TE	I	Tracking error signal (analog input)
34	RFENV	I	RF envelope signal
35	VDET	I	Oscillation det. signal ("H": det)
36	OFTR	I	Off track signal ("H": Off track)
37	TRCRS	I	Track cross signal input
38	RFDET	I	RF detection signal ("L": detection)
39	BDO	I	Dropout detection signal ("H": dropout)
40	LDON	O	Laser power control ("H": ON)
41	TES	O	Tracking error shunt output ("H": dropout) (Not used, open)
42	PLAY	O	Play signal ("H": play) (Not used, open)
43	WVEL	O	Double velocity status signal ("H": double) (Not used, open)
44	ARF	I	RF signal input
45	IREF	I	Reference current input
46	DRF	—	DSL bias terminal (Not used, open)
47	DSLIF	I/O	DSL loop filter terminal
48	PLLIF	I	PLL loop filter terminal
49	VCOF	I	VCO loop filter terminal
50	AVDD2	I	Power supply (analog circuit) terminal (2)
51	AVSS2	—	GND (analog circuit) terminal
52	384FS	O	384fs (16.9344MHz) output
53	PCK	—	PLL extract clock (f=4.3218MHz) (Not used, open)
54	TROF	—	Tracking servo OFF signal (Not used, open)

Pin No.	Mark	I/O Division	Function
55	SUBC	—	Sub-code serial output data (Not used, open)
56	SBCK	—	Sub-code serial input clock (Not used, connected to GND)
57	VSS	—	GND terminal
58	X1	I	Crystal oscillator input terminal (f=16.9344MHz)
59	X2	O	Crystal oscillator output terminal (f=16.9344MHz)
60	VDD	I	Power supply terminal
61	TRVSTOP	O	Traverse motor stop control terminal
62	CLDCK	—	Sub-code frame clock signal (f CLDCK=7.35kHz: Normal) (Not used, open)
63	FCLK	—	Crystal frame clock signal [f FCLK=7.35kHz: 2 speed(14.7kHz)] (Not used, open)
64	IPFLAG	—	Interpolation flag terminal (Not used, open)
65	FLAG0	—	Flag terminal (Not used, open)
66	CLVS	—	Turntable servo phase synchro signal ("H": CLV, "L": Rough servo) (Not used, open)
67	CRC	—	Sub-code CRC check terminal ("H": OK, "L": NG) (Not used, open)
68	DEMPHA	—	De-emphasis ON signal ("H": ON) (Not used, open)
69	FLAG6	O	Flag terminal
70	SEL	—	Not used, connected to GND
71	TEST	I	Test terminal (Normal: "H")
72	AVDD1	I	Power supply (analog circuit) terminal (1)
73	OUTL	O	Lch audio signal
74	AVSS1	—	GND (analog circuit) terminal (1)
75	OUTR	O	Rch audio signal
76	RSEL	I	Polarity direction control terminal of RF signal (Not used, connected to power supply)
77	CSEL	I	Frequency control terminal of crystal oscillator
78	ISRDATA	I	Serial data signal input
79	ILRCK	I	L/R discriminating signal input
80	IBCLK	I	Serial bit clock input

● IC502 (SM5859AF) : Shock proof controller

Pin No.	Mark	I/O Division	Function
1	VDD1	I	Power supply terminal
2	REMSEL	—	Not used, connected to GND
3	CHGSEL	—	Not used, open
4	RAMSEL	—	Not used, open
5	UC4	—	Not used, open
6	UC5	—	Not used, open
7	NTEST1	—	Test terminal (Not used, open)
8	NTEST2		
9	CLK	I	Clock signal input (f=16.9344MHz)
10	VSS	—	GND terminal
11	YSRDATA	I	Serial data input terminal
12	YLRCK	I	Serial L/R clock input terminal
13	YSCK	I	Serial bit clock input terminal
14	ZSCK	O	Serial bit clock output terminal
15	ZLRCK	O	L/R clock output terminal
16	ZSRDATA	O	Serial data output terminal
17	YFLAG	I	RAM over-flow flag terminal
18	YFCLK	I	Crystal frame clock input

Pin No.	Mark	I/O Division	Function
19	YBLKCK	I	Sub-code block clock input terminal
20	RESET	I	Reset input terminal
21	ZSENSE	O	Microcomputer states output terminal
22	UC6	—	Not used, open
23	YDMUTE	I	Mute input terminal
24	YMLD	I	Microcomputer latch clock input terminal
25	YMDATA	I	Microcomputer serial data input terminal
26	YMCLK	I	Microcomputer shift clock input terminal
27	NOE	O	D-RAM output enable terminal
28	NCAS	O	D-RAM column address strobe terminal
29	D2	I/O	D-RAM data input/output terminal
30	D3		
31	D0		
32	D1		
33	NWE	O	D-RAM write enable terminal
34	NRAS	O	D-RAM low address strobe terminal
35 ⋮ 41	A9 ⋮ A4	O	D-RAM address output terminal
42 ⋮ 44	A1 ⋮ A3		

● IC503 (M44400CJ7E2) : 4M DRAM

Pin No.	Mark	I/O Division	Function
1	D0	I/O	Data input/output terminal
2	D1	I/O	Data input/output terminal
3	NWE	I	Write enable terminal
4	NRAS	I	Low address strobe terminal
5	A9	I	Address input terminal
6	A0	I	Address input terminal
7 ⋮ 9	A1 ⋮ A3	I	Address input terminal

Pin No.	Mark	I/O Division	Function
10	VCC	I	Power supply terminal
11 ⋮ 15	A4 ⋮ A8	I	Address input terminal
16	NOE		
17	NCAS	I	Column address strobe terminal
18	D3	I/O	Data input/output terminal
19	D2	I/O	Data input/output terminal
20	GND	—	GND terminal

Replacement Parts List (Electrical and Cabinet)

- Notes:**
- Important safety notice:
Components identified by Δ mark have special characteristics important for safety.
Furthermore, special parts which have purposes of fire-retardant (resistors), high-quality sound (capacitors), low-noise (resistors), etc. are used.
When replacing any of components, be sure to use only manufacturer's specified parts shown in the parts list.
 - The parenthesized indications in the Remarks columns specify the areas. (Refer to the cover page for area.)
Parts without these indications can be used for all areas.
 - Warning: This product uses a laser diode. Refer to caution statements on pages 2, 3.
 - ACHTUNG: Die Lasereinheit nicht zerlegen.
Die Lasereinheit darf nur gegen eine vom Hersteller spezifizierte Einheit ausgetauscht werden.
 - [M] indicates in Remarks column parts that are supplied by MESA.

Ref. No.	Part No.	Part Name & Description	Remarks	Ref. No.	Part No.	Part Name & Description	Remarks
		INTEGRATED CIRCUIT (S)		Q401	UN5210TX	TRANSISTOR	[M]
IC11	AN8086SE2	IC	[M]	Q403	2SD1819QRSTX	TRANSISTOR	[M]
IC101	AN8837SBE1	IC	[M]	Q404	UN5215TX	TRANSISTOR	[M]
IC201	NJM2406FTE1	IC	[M]	Q405	UN5213TX	TRANSISTOR	[M]
IC301	SC436020CFU	IC	[M]	Q406	UN5210TX	TRANSISTOR	[M]
IC401	MPC17A50VMEL	IC	[M]	Q502	UN5113TX	TRANSISTOR	[M]
IC402	TC7S86FTE85L	IC	[M]	Q503, 504	UN5211TX	TRANSISTOR	[M]
IC501	MN662745RPC	IC	[M]	Q505	DTA143TUT106	TRANSISTOR	[M] SL-S650 only
IC502	SM5859AF	IC	[M]	Q506	UN5215TX	TRANSISTOR	[M] SL-S650 only
IC503	M44400CJ7E2	IC	[M]	Q601, 602	2SD1328QRSTX	TRANSISTOR	[M]
IC701	NJU7082AMTE1	IC	[M]	Q603	XN1215TX	TRANSISTOR	[M]
		TRANSISTOR (S)		Q604	2SB709QRSTX	TRANSISTOR	[M]
Q10	2SD2074HWSTT	TRANSISTOR	[M]	Q605	XN1501TX	TRANSISTOR	[M]
Q11, 12	2SD1450STTA	TRANSISTOR	[M]	Q701, 702	2SD1328QRSTX	TRANSISTOR	[M]
Q13	2SD1328QRSTX	TRANSISTOR	[M]	Q705	XN1215TX	TRANSISTOR	[M]
Q14	2SD1819QRSTX	TRANSISTOR	[M]	Q901, 902	2SD1819QRSTX	TRANSISTOR	[M] SL-S650 only
Q16	XN2401TX	TRANSISTOR	[M]	Q903	DTA114YUA106	TRANSISTOR	[M] SL-S650 only
Q17	2SB970RSTX	TRANSISTOR	[M]	Q906	DTA114YUA106	TRANSISTOR	[M]
Q18	UN5115TX	TRANSISTOR	[M]	Q907	XN1210TX	TRANSISTOR	[M]
Q19	XN1213TX	TRANSISTOR	[M]	Q910	2SB1218QRSTX	TRANSISTOR	[M] SL-S650 only
Q20	2SD1328-S	TRANSISTOR	[M] SL-S650 only	Q911	2SD1819QRSTX	TRANSISTOR	[M] SL-S650 only
Q21	UN5211TX	TRANSISTOR	[M] SL-S650 only	Q912	UN5211TX	TRANSISTOR	[M] SL-S650 only
Q22	UN5213TX	TRANSISTOR	[M] SL-S650 only	Q913	UN5215TX	TRANSISTOR	[M] SL-S650 only
Q23	DTA114YUA106	TRANSISTOR	[M] SL-S650 only	Q915, 916	2SD1819QRSTX	TRANSISTOR	[M] SL-S650 only
Q52	2SB970RSTX	TRANSISTOR	[M]			DIODE (S)	
Q53	2SD1758TLPQR	TRANSISTOR	[M]	D10	MA8033LTX	DIODE	[M]
Q55	UN521VTX	TRANSISTOR	[M]	D11, 12	MA110TX	DIODE	[M]
Q56	UN5115TX	TRANSISTOR	[M]	D13	RB411DT146	DIODE	[M]
Q57	UN5211TX	TRANSISTOR	[M]	D15	MA110TX	DIODE	[M]
Q201	2SB970RSTX	TRANSISTOR	[M]	D16	MA110TX	DIODE	[M] SL-S650 only
Q202	2SB709QRSTX	TRANSISTOR	[M]	D201	RB411DT146	DIODE	[M]
Q204	2SB709QRSTX	TRANSISTOR	[M]	D202	MA110TX	DIODE	[M]
Q301	XN1501TX	TRANSISTOR	[M]	D301	MA110TX	DIODE	[M]
Q302	2SD1819QRSTX	TRANSISTOR	[M]	D302	MA8047MTX	DIODE	[M]
Q304	2SD1819QRSTX	TRANSISTOR	[M] SL-S651C only	D313	MA141WKTIX	DIODE	[M]
Q305	UN5211TX	TRANSISTOR	[M] SL-S651C only	D401	MA110TX	DIODE	[M]
Q306	XP0121N00L	TRANSISTOR	[M]	D402	MA8082MTX	DIODE	[M]
Q307	2SD1819QRSTX	TRANSISTOR	[M] SL-S651C only	D403	MA110TX	DIODE	[M]
Q308	UN5211TX	TRANSISTOR	[M]	D404	MA142WATX	DIODE	[M]
Q309	UN5115TX	TRANSISTOR	[M]	D601	MA110TX	DIODE	[M]
Q310	UN5115TX	TRANSISTOR	[M] SL-S651C only	D801-808	LN1371GH6UTR	L. E. D.	[M] SL-S651C only
				D809-812	LNJ310MGJURA	L. E. D.	[M]
				D903	MA141WKTIX	DIODE	[M] SL-S650 only

Ref. No.	Part No.	Part Name & Description	Remarks	Ref. No.	Part No.	Part Name & Description	Remarks
D904	MA141WRTX	DIODE	[M]	CN801	RJS2A4530T	CONNECTOR(30P)	[M]
		IC PROTECTOR(S)		JK11	RJJ43KD9-C	DC IN JACK	[M]
				JK601	RJJD3S5ZB-C	OUT JACK	[M]
ICP11	UNHD00700A	IC PROTECTOR	[M]△	JK701	RJJ36TD2-C	HEADPHONES JACK	[M]
		VARIABLE RESISTOR(S)				<PRINTED CIRCUIT BOARDS ASS'Y>	
VR11	EVMIYSX50B33	V. R	[M]	PCB1	REP2431D-M	MAIN P. C. B. ASS'Y	[M]<RTL>SL-S650 only
VR701	EVUTUEB09C54	V. R	[M]	PCB2	REP2432B-S	OPERATION P. C. B. ASS'Y	[M]<RTL>SL-S650 only
		COIL(S)				CABINET AND CHASSIS	
L12	ELL7URD001	COIL	[M]	1	RKK0102-K	BATTERY COVER	[M]
L14	RLQU331KT-W	COIL	[M]	2	RGV0199-H	X-DSSP KNOB	[M]
L201	RLQB471KT1-K	COIL	[M]	3	RGV0200-K	TRAIN/S-XBS, PLAY MODE KNOB	[M]
L202	RLQQ330JT-D	COIL	[M]	4	RJC93020	COMMON BATTERY TERMINAL	[M]
L301	RLQU331KT-W	COIL	[M]	5	RFKJLS650P-S	BOTTOM CABINET ASS'Y	[M](P) SL-S650 only
L401	RLQU331KT-W	COIL	[M]	5	RFKJLS650EBS	BOTTOM CABINET ASS'Y	[M](EB) SL-S650 only
L601-603	RLBV102V-Y	COIL	[M]	5	RFKJLS650EGS	BOTTOM CABINET ASS'Y	[M](EG) SL-S650 only
		COMPONENT COMBINATION(S)		5	RFKJLS650GCS	BOTTOM CABINET ASS'Y	[M](GC) SL-S650 only
				5	RFKJLS650GNS	BOTTOM CABINET ASS'Y	[M](GN) SL-S650 only
Z301	RCDRS-52	REMOTE SENSOR	[M] SL-S651C only	5	RFKJLS651CPS	BOTTOM CABINET ASS'Y	[M] SL-S651C only
		OSCILLATOR(S)		5-1	RKA0063-K	FOOT	[M]
X501	RSXZ16M9M04T	OSCILLATOR	[M]	6	RMA0677	REAR ORNAMENT	[M]
		LCD(S)		7	RME0239	OPEN SPRING	[M]
LCD801	RSL5153-L	LCD	[M]	8	RMS0570	SHAFT	[M]
		SWITCH(ES)		9	RFKLLS650P-S	CD COVER ASS'Y	[M] SL-S650 only
S201	ESE11SV6	SW	[M]	9	RFKLLS651CPS	CD COVER ASS'Y	[M] SL-S651C only
S202	ESE11HS4	SW	[M]	10	RGU1488-H	OPERATION BUTTON	[M] SL-S650 only
S305	RSS3A007-1A	SW	[M]	10	RGU1488-C	OPERATION BUTTON	[M] SL-S651C only
S306	ESE11MHLT	SW	[M]	11	RHE5119YA	SCREW	[M]
S501	RSS2A010-1A	SW	[M]	12	RHE5155YA	SCREW	[M]
S701	RSS3B018-A	SW	[M]	13	RJB1819A	FFC(30P)	[M]
S801-806	RSG0030-P	SW	[M]	14	RJF0027	LCD HOLDER	[M]
		CONNECTOR(S) AND JACK(S)		15	RMA0937	HOLD PLATE	[M]
CN11	RJC93015-1	BATTERY TERMINAL(+)	[M]	16	RMA1029	LID COVER	[M]
CN12	RJC93015-1	BATTERY TERMINAL(-)	[M]	17	RSQ0048	ZEBRA RUBBER	[M]
CN13	RJH5102-1	RECHARGEABLE BATT. TERMINAL	[M]	18	RYK0690A-K	INTERMEDIATE CABINET ASS'Y	[M]
CN14	RJH9208	BATT. CASE CONNECT. TERMINAL	[M] SL-S650 only	18-1	RGU1489-K	OPEN BUTTON	[M]
CN101	RJS2A5016T	CONNECTOR(16P)	[M]	18-2	RGV0198-H	HOLD-LOCK KNOB	[M]
CN301	RJS1A8830T	CONNECTOR(30P)	[M]	18-3	RME0238	HOLD SPRING	[M]
CN401	RJS2A5106T	CONNECTOR(6P)	[M]	18-4	RMR1048-G	LOCK PLATE(A)	[M]
				18-5	RMR1049-G	LOCK PLATE(B)	[M]
				18-6	RMR1050-K	STOPPER	[M]
				18-7	RHE5119YA	SCREW	[M]
				19	XTN17-6GFZ	SCREW	[M]
				20	RAED142Z	TRAVERSE DECK	[M]△
				20-1	RMG0449-H	FLOATING RUBBER	[M]
				21	RMZ0365	LCD REFLECTION SHEET	[M]
				22	RKW0492-K	FILTER	[M] SL-S651C only

Resistors and Capacitors

Notes: * Capacity values are in microfarads (uF) unless specified otherwise. P=Pico-farads (pF) F=Farads (F)
 • Resistance values are in ohms, unless specified otherwise, 1K=1,000 (OHM), 1M=1,000K (OHM).
 • [M] indicates in Remarks columns parts that are supplied by MESA.
 • (* 1) indicates in Values & Remarks columns parts list that can be used only model No. SL-S650.
 • (* 2) indicates in Values & Remarks columns parts list that can be used only model No. SL-S651C.

Ref. No.	Part No.	Values & Remarks	Ref. No.	Part No.	Values & Remarks	Ref. No.	Part No.	Values & Remarks
		RESISTORS	R206	ERJ3GEYJ333V	1/16W 33K [M]	R542, 543	ERJ3GEYJ103Z	1/16W 10K [M]
			R207	ERJ3GEYJ473V	1/16W 47K [M]	R601, 602	ERJ3GEYJ681V	1/16W 680 [M]
			R208	ERJ3GEYJ563V	1/16W 56K [M]	R603, 604	MCR03PZHJ561	1/16W 560 [M]
R10	ERJ3GEYJ102Z	1/16W 1K [M]	R212	ERJ3GEYJ333V	1/16W 33K [M]	R605, 606	ERJ3GEYJ473V	1/16W 47K [M]
R11, 12	ERJ3GEYJ101V	1/16W 100 [M]	R213	ERJ3GEYJ103Z	1/16W 10K [M]	R607, 608	ERJ3GEYJ102Z	1/16W 1K [M]
R13	ERJ3GEYJ100V	1/16W 10 [M]	R214	ERJ3GEYJ822V	1/16W 8.2K [M]	R609, 610	ERJ3GEYJ332V	1/16W 3.3K [M]
R14	ERJ3GEYJ681V	1/16W 680 [M]	R215	ERJ3GEYJ393V	1/16W 39K [M]	R611	ERJ3GEYJ471V	1/16W 470 [M]
R15	ERJ3GEYJ221V	1/16W 220 [M]	R216, 217	ERJ3GEYJ223V	1/16W 22K [M]	R612	ERJ3GEYJ682V	1/16W 6.8K [M]
R16	ERJ3GEYJ103Z	1/16W 10K [M] (*1)	R218	ERJ3GEYJ224V	1/16W 220K [M]	R613	ERJ3GEYJ103Z	1/16W 10K [M]
R17	ERJ3GEYJ223V	1/16W 22K [M]	R302	ERJ3GEYJ182V	1/16W 1.8K [M]	R614	ERJ3GEYJ104Z	1/16W 100K [M]
R18	ERJ3GEYJ474V	1/16W 470K [M]	R303	ERJ3GEYJ470V	1/16W 47 [M] (*2)	R615	ERJ3GEYJ682V	1/16W 6.8K [M]
R19	ERJ3GEYJ472V	1/16W 4.7K [M]	R304	ERJ3GEYJ103Z	1/16W 10K [M]	R616	ERJ3GEYJ222V	1/16W 2.2K [M]
R20	ERJ3GEYJ392V	1/16W 3.9K [M]	R305	ERJ3GEYJ102Z	1/16W 1K [M] (*2)	R703, 704	ERJ3GEYJ103Z	1/16W 10K [M]
R21	ERJ3GEYJ153V	1/16W 15K [M]	R307	ERJ3GEYJ472V	1/16W 4.7K [M]	R705, 706	ERJ3GEYJ473V	1/16W 47K [M]
R22	ERJ3GEYJ333V	1/16W 33K [M]	R317-319	ERJ3GEYJ473V	1/16W 47K [M]	R707, 708	ERJ3GEYJ223V	1/16W 22K [M]
R23	ERJ3GEYJ223V	1/16W 22K [M]	R320-322	ERJ3GEYJ103Z	1/16W 10K [M]	R709-712	ERJ3GEYJ105V	1/16W 1M [M]
R24	ERJ3GEYJ184V	1/16W 180K [M]	R324	ERJ3GEYJ103Z	1/16W 10K [M]	R715, 716	ERJ3GEYJ183V	1/16W 18K [M]
R25	ERJ3GEYJ472V	1/16W 4.7K [M]	R325, 326	ERJ3GEYJ102Z	1/16W 1K [M]	R717, 718	ERJ3GEYJ392V	1/16W 3.9K [M]
R26	ERJ3GEYJ152V	1/16W 1.5K [M] (*1)	R327	ERJ3GEYJ153V	1/16W 15K [M]	R719, 720	ERJ3GEYJ103Z	1/16W 10K [M]
R27	ERJ3GEYJ473V	1/16W 47K [M]	R329-331	ERJ3GEYJ472V	1/16W 4.7K [M]	R721, 722	ERJ3GEYJ273V	1/16W 27K [M]
R28, 29	ERJ3GEYJ104Z	1/16W 100K [M]	R332	ERJ3GEYJ102Z	1/16W 1K [M]	R723, 724	ERJ3GEYJ104Z	1/16W 100K [M]
R30, 31	ERJ3GEYJ334V	1/16W 330K [M]	R400	ERJ3GEYJ472V	1/16W 4.7K [M]	R725, 726	ERJ3GEYJ150V	1/16W 15 [M]
R32	ERJ3GEYJ332V	1/16W 3.3K [M]	R401	ERJ3GEYJ473V	1/16W 47K [M]	R727, 728	ERJ3GEYJ185V	1/16W 1.5 [M]
R33	ERJ3GEYJ222V	1/16W 2.2K [M]	R402	ERJ3GEYJ472V	1/16W 4.7K [M]	R729, 730	ERJ3GEYJ472V	1/16W 4.7K [M]
R34	ERJ3GEYJ224V	1/16W 220K [M]	R403	ERJ3GEYJ223V	1/16W 22K [M]	R731, 732	ERJ3GEYJ331V	1/16W 330 [M]
R35	ERJ3GEYJ823V	1/16W 82K [M]	R405	ERJ3GEYJ222V	1/16W 2.2K [M]	R733	ERJ3GEYJ822V	1/16W 8.2K [M]
R36	ERJ3GEYJ471V	1/16W 470 [M]	R406	ERJ3GEYJ123V	1/16W 12K [M]	R739	ERJ3GEYJ181V	1/16W 180 [M]
R37	ERJ3GEYJ222V	1/16W 2.2K [M]	R408	ERJ3GEYJ103Z	1/16W 10K [M]	R801-806	ERJ3GEYJ331V	1/16W 330 [M] (*2)
R38	ERJ3GEYJ222V	1/16W 2.2K [M] (*1)	R409	ERJ3GEYJ682V	1/16W 6.8K [M]	R807, 808	ERJ3GEYJ151V	1/16W 150 [M] (*2)
R39	ERJ3GEYJ223V	1/16W 22K [M]	R411, 412	ERJ3GEYJ103Z	1/16W 10K [M]	R809-812	ERJ3GEYJ560V	1/16W 56 [M] (*1)
R54	ERJ3GEYJ471V	1/16W 470 [M]	R413	ERJ3GEYJ472V	1/16W 4.7K [M]	R809-812	ERJ8GEYJ560V	1/8W 56 [M] (*2)
R59	ERJ12YJ2R7H	1/2W 2.7 [M]	R414	ERJ3GEYJ473V	1/16W 47K [M]	R901	ERJ3GEYJ274V	1/16W 270K [M] (*1)
R62	ERJ3GEYJ122V	1/16W 1.2K [M]	R501	ERJ3GEYJ683V	1/16W 68K [M]	R902	ERJ3GEYJ102Z	1/16W 1K [M] (*1)
R63	ERJ3GEYJ681V	1/16W 680 [M]	R502	ERJ3GEYJ223V	1/16W 22K [M]	R910	ERJ3GEYJ334V	1/16W 330K [M]
R64	ERJ3GEYJ331V	1/16W 330 [M]	R503	ERJ3GEYJ473V	1/16W 47K [M]	R912	ERJ3GEYJ152V	1/16W 1.5K [M] (*1)
R105	ERJ3GEYJ333V	1/16W 33K [M]	R504	ERJ3GEYJ474V	1/16W 470K [M]	R913	ERJ3GEYJ473V	1/16W 47K [M]
R106	ERJ3GEYJ124V	1/16W 120K [M]	R505	ERJ3GEYJ221V	1/16W 220 [M]	R914	ERJ3GEYJ103Z	1/16W 10K [M] (*1)
R107	ERJ3GEYJ683V	1/16W 68K [M]	R506	ERJ3GEYJ821V	1/16W 820 [M]	R915	ERJ3GEYJ332V	1/16W 3.3K [M] (*1)
R108	ERJ3GEYJ563V	1/16W 56K [M]	R508	ERJ3GEYJ122V	1/16W 1.2K [M]	R916	ERJ3GEYJ472V	1/16W 4.7K [M] (*1)
R109	ERJ3GEYJ223V	1/16W 22K [M]	R512	ERJ3GEYJ471V	1/16W 470 [M]	R917, 918	ERJ3GEYJ821V	1/16W 820 [M]
R110	ERJ3GEYJ124V	1/16W 120K [M]	R513	ERJ3GEYJ222V	1/16W 2.2K [M]	R919	ERJ3GEYJ680V	1/16W 68 [M] (*1)
R111	ERJ3GEYJ102Z	1/16W 1K [M]	R514	ERJ3GEYJ333V	1/16W 33K [M]	R920	ERJ3GEYJ470V	1/16W 47 [M] (*1)
R112	ERJ3GEYJ472V	1/16W 4.7K [M]	R515	ERJ3GEYJ681V	1/16W 680 [M]	R921	ERJ3GEYJ474V	1/16W 470K [M] (*1)
R113, 114	ERJ3GEYJ330V	1/16W 33 [M]	R526	ERJ3GEYJ102Z	1/16W 1K [M]	R922	ERJ3GEYJ224V	1/16W 220K [M] (*1)
R115	ERJ3GEYJ102Z	1/16W 1K [M]	R532	ERJ3GEYJ472V	1/16W 4.7K [M]	R923	ERJ3GEYJ474V	1/16W 470K [M] (*1)
R201	ERJ3GEYJ102Z	1/16W 1K [M]	R533	ERJ3GEYJ224V	1/16W 220K [M]	R924	ERJ3GEYJ154V	1/16W 150K [M] (*1)
R202	ERJ3GEYJ122V	1/16W 1.2K [M]	R534	ERJ3GEYJ103Z	1/16W 10K [M]			
R204	ERJ3GEYJ104Z	1/16W 100K [M]	R535-538	ERJ3GEYJ152V	1/16W 1.5K [M]			CHIP JUMPERS
R205	ERJ3GEYJ332V	1/16W 3.3K [M]	R539-541	ERJ3GEYJ473V	1/16W 47K [M]			

Ref. No.	Part No.	Values & Remarks	Ref. No.	Part No.	Values & Remarks			
R61	ERJ3GEY0R00V	CHIP JUMPER[M]	C304, 305	ECUVNC104ZFV	16V 0.1U [M]			
R66	ERJ3GEY0R00V	CHIP JUMPER[M]	C306	ECUVNC105ZFN	16V 1U [M]			
R410	ERJ3GEY0R00V	CHIP JUMPER[M]	C307	ECUVNC104ZFV	16V 0.1U [M]			
R507	ERJ3GEY0R00V	CHIP JUMPER[M]	C333	ECUV1H221KBV	50V 220P [M]			
RJ12	ERJ3GEY0R00V	CHIP JUMPER[M]	C401-403	ECUV1H471KBV	50V 470P [M]			
RJ501	ERJ3GEY0R00V	CHIP JUMPER[M] (*1)	C404	ECUVNC105ZFN	16V 1U [M]			
RJ502	ERJ3GEY0R00V	CHIP JUMPER[M]	C406	ECUV1H151KBV	50V 150P [M]			
RJ504	ERJ3GEY0R00V	CHIP JUMPER[M] (*2)	C407	ECST0JY106RR	6.3V 10U [M]			
RJ505	ERJ3GEY0R00V	CHIP JUMPER[M]	C408	ECUVNC105ZFN	16V 1U [M]			
			C409	ECUV1H151KBV	50V 150P [M]			
		CAPACITORS	C410	ECUV1H471KBV	50V 470P [M]			
			C413, 414	ECUV1H471KBV	50V 470P [M]			
C10	ECUVNC104ZFV	16V 0.1U [M]	C415	ECUVNC104ZFV	16V 0.1U [M]			
C11, 12	ECUVNC104ZFV	16V 0.1U [M] (*1)	C416	ECUVNC105ZFN	16V 1U [M]			
C13	RCE0JSA4701X	6.3V 47U [M]	C417	ECUV1H471KBV	50V 470P [M]			
C14	ECEA0JKA1011	6.3V 100U [M]	C418	ECUV1H331KBV	50V 330P [M]			
C15	ECUV1E103KBV	25V 0.01U [M]	C420	ECUVNC105ZFN	16V 1U [M]			
C17	ECEA1AKN100	10V 10U [M]	C501, 502	ECUV1H150JCV	50V 15P [M]			
C18	ECUV1H331KBV	50V 330P [M]	C503	ECUV1H561KBV	50V 560P [M]			
C19	ECUV1C104KBV	16V 0.1U [M]	C504	ECUV1C473KBV	16V 0.047U [M]			
C20	ECST1AY475RR	10V 4.7U [M]	C505	ECUV1E223KBV	25V 0.022U [M]			
C21	ECUV1E223KBV	25V 0.022U [M]	C507	ECEV0GA221SP	4V 220U [M]			
C22	ECUVNC104ZFV	16V 0.1U [M]	C508	ECUVNC104ZFV	16V 0.1U [M]			
C24	RCE1ASC4R71X	10V 4.7U [M]	C509	ECUV1H470KCV	50V 47P [M]			
C25	ECUVNC224KBN	16V 0.22U [M]	C510, 511	ECUVNC474KBN	16V 0.47U [M]			
C26	ECUV1H331KBV	50V 330P [M]	C512	ECUV1E103KBV	25V 0.01U [M]			
C28	ECEV0GA471P	4V 470U [M]	C513	ECUV1H102KBV	50V 1000P [M]			
C29	ECEA1AKA2211	10V 220U [M]	C514	ECUVNC104ZFV	16V 0.1U [M]			
C30	ECUV1H470KCV	50V 47P [M]	C515	ECUV1H332KBV	50V 3300P [M]			
C31	ECUVNC224KBN	16V 0.22U [M]	C525-527	ECUVNC104ZFV	16V 0.1U [M]			
C32	ECST1AY475RR	10V 4.7U [M]	C600	ECUVNC104ZFV	16V 0.1U [M]			
C101	ECUV1C104KBV	16V 0.1U [M]	C601, 602	ECUV1H102KBV	50V 1000P [M]			
C103	ECUV1C273KBV	16V 0.027U [M]	C603, 604	ECUV1H272KBV	50V 2700P [M]			
C106	ECUV1H391KBV	50V 390P [M]	C605, 606	ECST0JY106RR	6.3V 10U [M]			
C107	ECUV1H221KBV	50V 220P [M]	C607, 608	ECUV1H681KBV	50V 680P [M]			
C108	ECUV1C473KBV	16V 0.047U [M]	C609	ECUVNC104ZFV	16V 0.1U [M]			
C109	ECUV1C333KBV	16V 0.033U [M]	C610	ECEA0GPK2211	4V 220U [M]			
C110	ECUV1E223KBV	25V 0.022U [M]	C611, 612	ECUVNC104ZFV	16V 0.1U [M]			
C111	ECUV1C273KBV	16V 0.027U [M]	C613	ECST0JX226RR	6.3V 22U [M]			
C113	ECUVNC104ZFV	16V 0.1U [M]	C703, 704	ECUV1E123KBV	25V 0.012U [M]			
C114	ECUVNC474KBN	16V 0.47U [M]	C705, 706	ECUV1C333KBV	16V 0.033U [M]			
C115	ECUV1E223KBV	25V 0.022U [M]	C707, 708	ECUV1H102KBV	50V 1000P [M]			
C117	ECUV1H332KBV	50V 3300P [M]	C709, 710	ECEA0GPK2211	4V 220U [M]			
C201	RCE0JSL4701X	6.3V 47U [M]	C711, 712	ECST0JY106RR	6.3V 10U [M]			
C202	ECUVNC224KBN	16V 0.22U [M]	C713	ECEA0JPK1011	6.3V 100U [M]			
C203	ECST1AY225RR	10V 2.2U [M]	C714	ECUVNC104ZFV	16V 0.1U [M]			
C204	ECUV1H101KCV	50V 100P [M]	C715	ECUVNC105ZFN	16V 1U [M]			
C206	ECUV1E103KBV	25V 0.01U [M]	C901, 902	ECUV1H332KBV	50V 3300P [M] (*1)			
C207, 208	ECUV1H102KBV	50V 1000P [M]	C903	ECUVNC104ZFV	16V 0.1U [M]			
C301	ECST0JY156RR	6.3V 15U [M]	C904	ECUV1E223KBV	25V 0.022U [M] (*1)			
C302	ECUVNC104ZFV	16V 0.1U [M] (*2)						
C303	ECST0JY475RR	6.3V 4.7U [M] (*2)						

Replacement Parts List (Packing, Accessories and Jig)

Notes: * Important safety notice:

- Components identified by Δ mark have special characteristics important for safety. Furthermore, special parts which have purposes of fire-retardant (resistors), high-quality sound (capacitors), low-noise (resistors), etc. are used. When replacing any of components, be sure to use only manufacturer's specified parts shown in the parts list.
- The parenthesized indications in the Remarks columns specify the areas. (Refer to the cover page for area.) Parts without these indications can be used for all areas.
 - Warning: This product uses a laser diode. Refer to caution statements on pages 2,3.
 - ACHTUNG: Die Lasereinheit nicht zerlegen.
Die Lasereinheit darf nur gegen eine vom Hersteller spezifizierte Einheit ausgetauscht werden.
 - [M] indicates in Remarks column parts that are supplied by MESA.

Ref. No.	Part No.	Part Name & Description	Remarks	Ref. No.	Part No.	Part Name & Description	Remarks
		<SL-S650 only>		A9	RQX7433ZA	WARRANTY CARD	[M] (GN)
		PACKING MATERIAL		A10	RQCB0169	SERVICENTER LIST	[M] (EB, EG, GC, GN)
				A11	SJP5213-2	POWER PLUG ADAPTOR	[M] Δ (GC)
						<SL-S651C only>	
P1	RPKD862	PACKING CASE	[M] (P)			PACKING MATERIAL	
P1	RPKD863	PACKING CASE	[M] (EB, EG, GC, GN)	P1	RPKD865	PACKING CASE	[M] (P)
P2	RPQ0752	SPACER	[M] (P)	P1	RPKD866	PACKING CASE	[M] (PC)
P2	RPQ0753	SPACER	[M] (EB, EG, GN)	P2	RPQ0677	SPACER	[M]
P2	RPQ0683	SPACER	[M] (GC)	P3	RPFD111	PROTECTION BAG (UNIT)	[M]
P3	RPFD111	PROTECTION BAG (UNIT)	[M]	P3	RPFD111	PROTECTION BAG (UNIT)	[M]
P4	RPFD046	PROTECTION BAG (F. B.)	[M] (EB, EG, GC, GN)	P4	RPFD046	PROTECTION BAG (F. B.)	[M] (PC)
		ACCESSORIES				ACCESSORIES	
A1 *1	RQT3755-P	INSTRUCTION MANUAL	[M] (P) <IA>	A1 *1	RQT3755-P	INSTRUCTION MANUAL	[M] <IA>
A1	RQT3757-B	INSTRUCTION MANUAL	[M] (EB, GN) <IA>	A1	RQT3825-P	INST. MANUAL (CAR MOUNT KIT)	[M] <IA>
A1	RQT3759-E	INSTRUCTION MANUAL	[M] (EG, GC) <IB>	A1	RQT3518-C	INSTRUCTION MANUAL	[M] (PC) <IB>
A1	RQT3760-R	INSTRUCTION MANUAL	[M] (EG) <IC>	A1	RQT3756-C	INST. MANUAL (CAR MOUNT KIT)	[M] (PC) <IB>
A1	RQT3761-D	INSTRUCTION MANUAL	[M] (EG) <ID>	A2	RFEA403C-S	AC ADAPTOR	[M] Δ
A1	RQT3762-H	INSTRUCTION MANUAL	[M] (EG) <IE>	A3	RFEV317P-KS	STEREO EARPHONES	[M]
A1	RQT3999-J	INSTRUCTION MANUAL	[M] (EG) <IF>	A4 *2	RKB205ZA-0	EAR PADS	[M]
A1	RQT3758-K	INSTRUCTION MANUAL	[M] (GC) <IG>	A5	EURNTR1026P	WIRELESS REMOTE CONTROLLER	[M]
A2	RFA0627-K4	BATTERY CASE	[M]	A5-1	RAK-SL931WK	BATTERY COVER FOR W. R. C.	[M]
A3	RFEA403C-S	AC ADAPTOR	[M] Δ (P)	A6	SH-CDC2PPY	CAR ADAPTOR	[M] Δ
A3	RFEA404B-1W	AC ADAPTOR	[M] Δ (EB)	A6-1	XBA1C05NBAU	FUSE, 500mA (IN CAR ADAPTOR)	[M] Δ
A3	RFEA401E-3S	AC ADAPTOR	[M] Δ (EG)	A7	SH-CDBASY-K	CAR STEREO CASSETTE ADAPTOR	[M]
A3	RFEA403Z-S	AC ADAPTOR	[M] Δ (GC)	A8	SQX9131	SERVICENTER LIST	[M] (PC)
A3	RFEA403A-S	AC ADAPTOR	[M] Δ (GN)	A9	SQX7185	WARRANTY CARD	[M] (PC)
A4	RFEV006PCKM	WIRED REMOTE CONTROLLER	[M]			<GREASE OR JIG/TOOL>	
A5	RFEV316P-K1S	STEREO EARPHONES	[M]			TEST DISC	
A6 *2	RKB205ZA-0	EAR PADS	[M]	SA1	SZZP1054C	PLAYABILITY TEST DISC	[M]
A7	RFKFP3GAVE2S	RECHARGEABLE BATTERY ASS'Y	[M] (EB, EG)	SA2	SZZP1056C	UNEVEN TEST DISC	[M]
A7	RFKFP3GAVT2S	RECHARGEABLE BATTERY ASS'Y	[M] (GC, GN)				
A7-1	RFKNLS370-K	BATTERY CARRYING CASE ASS'Y	[M] (EB, EG, GC, GN)				
A8	RFC0041-K	SOFT CASE	[M] (EB, EG, GC, GN)				
A9	RQAD117	WARRANTY CARD	[M] (EB, EG)				

Notes: ● "<IA> ~ <IG>" marks in Remarks indicate language of instruction manual.

(<IA>: English/ <IB>: English, Spanish/ <IC>: Swedish, Russian/ <ID>: German, Italian/ <IE>: French, Dutch/ <IF>: Danish/ <IG>: Chinese)

- * 1: The servicenter list and the warranty card are included in the instruction manual.
- * 2: This item is not attacked merchandise, but it is supplied as a replacement part.
- The marking (RTL) indicates that the Retention Time is limited for this item. After the discontinuation of this assembly in production, the item will continue to be available for a specific period of time. The retention period of availability is dependant on the type of assembly, and in accordance with the laws governing part and product retention. After the end of this period, the assembly will no longer be available.

■ Packaging

● SL-S650 (P) only

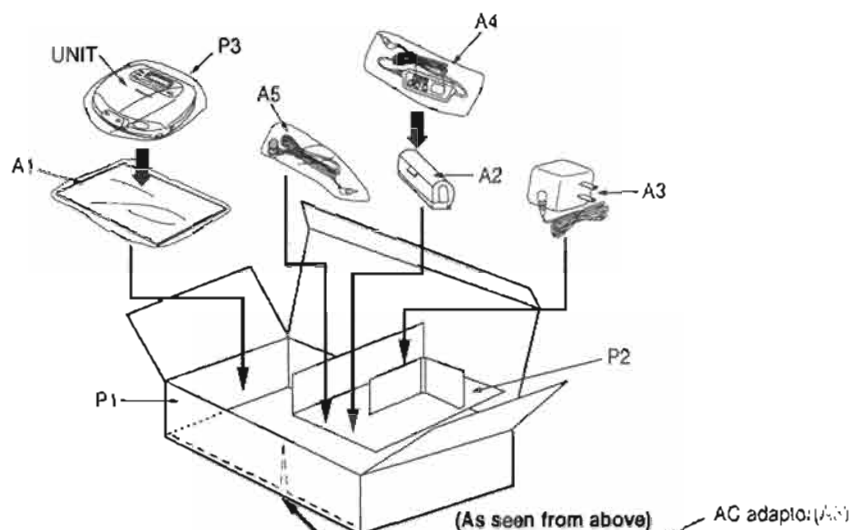

Notes: Be careful about the direction of all accessories.
(see the picture as seen from above)

- Place the stereo earphones(A5) in between the battery case(A2) and the packing case(P1).
- Put the wired remote controller(A4) on the battery case(A2).

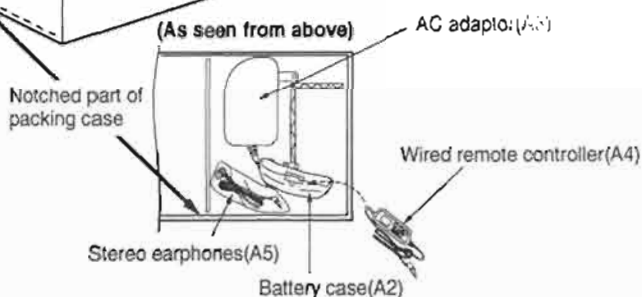

● SL-S651C (P,PC) only

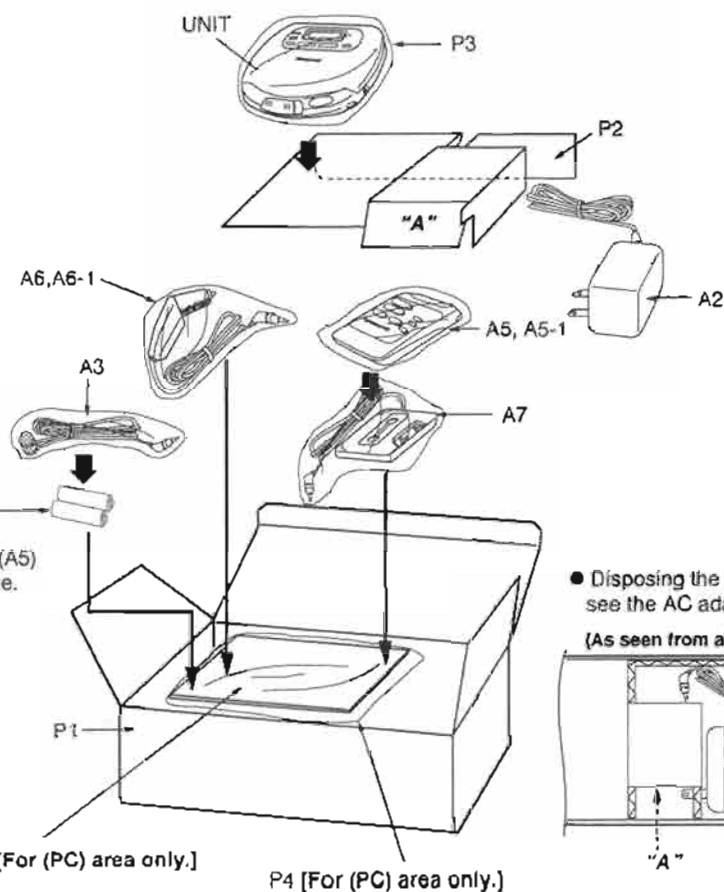

Batteries for wireless remote controller(A5)
Note: these are available on sales route.

- Disposing the "A" part to be able to see the AC adaptor's plug.

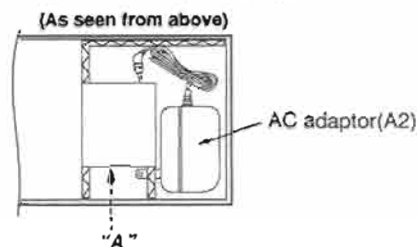

● SL-S650 (EG,EB,GN) only

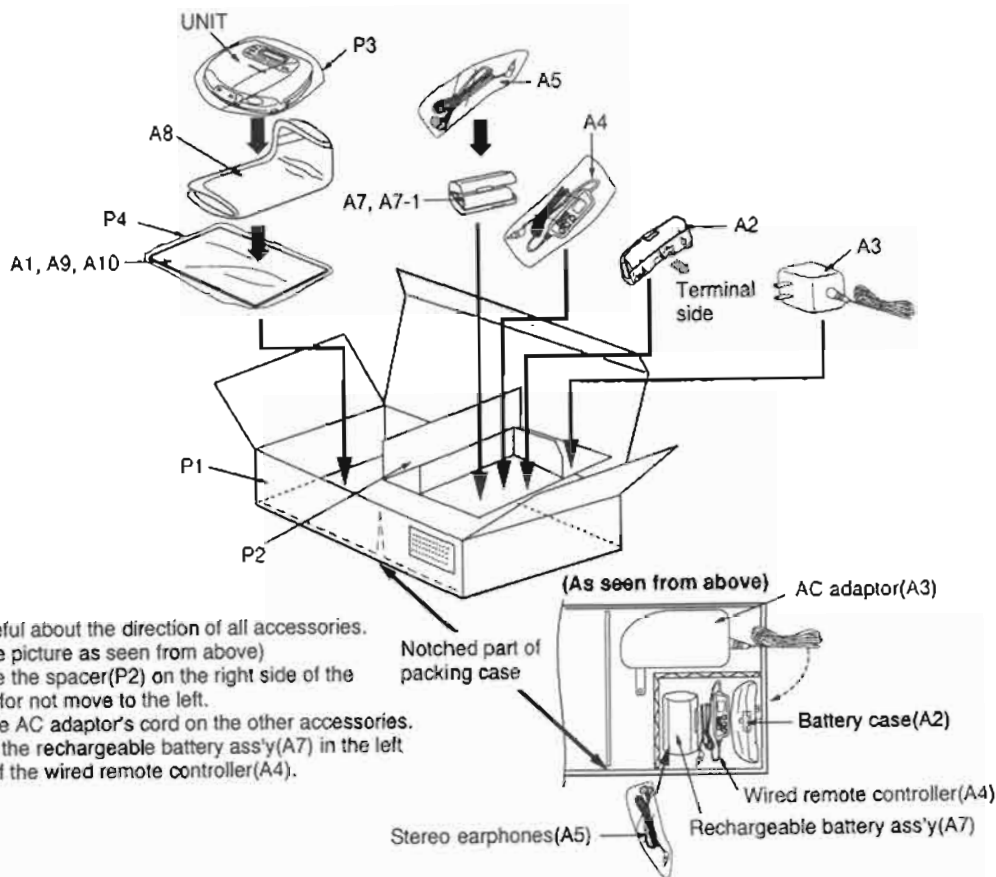

- Notes: Be careful about the direction of all accessories.
(see the picture as seen from above)
- Locate the spacer(P2) on the right side of the notch for not move to the left.
 - Put the AC adaptor's cord on the other accessories.
 - Place the rechargeable battery ass'y(A7) in the left side of the wired remote controller(A4).

● SL-S850 (GC) only

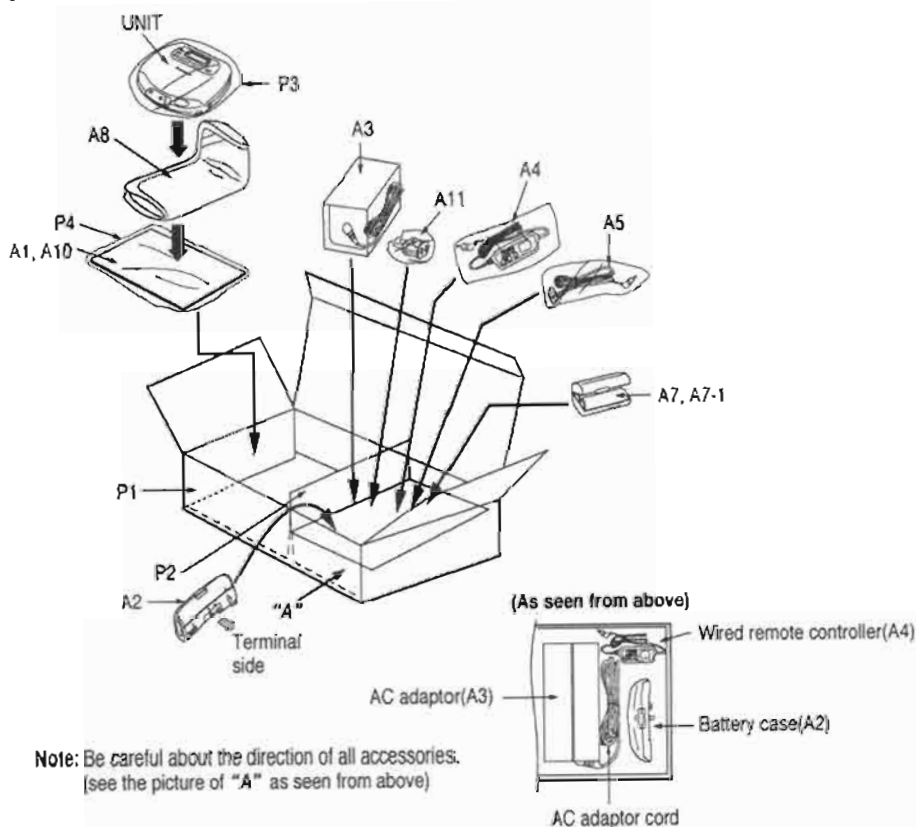

- Note: Be careful about the direction of all accessories.
(see the picture of "A" as seen from above)