

1 2 3 4 5

A
B
C
D
E
F

A MAIN CIRCU

For [E, EB, EF, EP] areas.

For [EG, EI, GC, GN] areas.

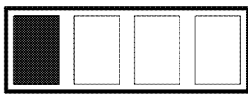
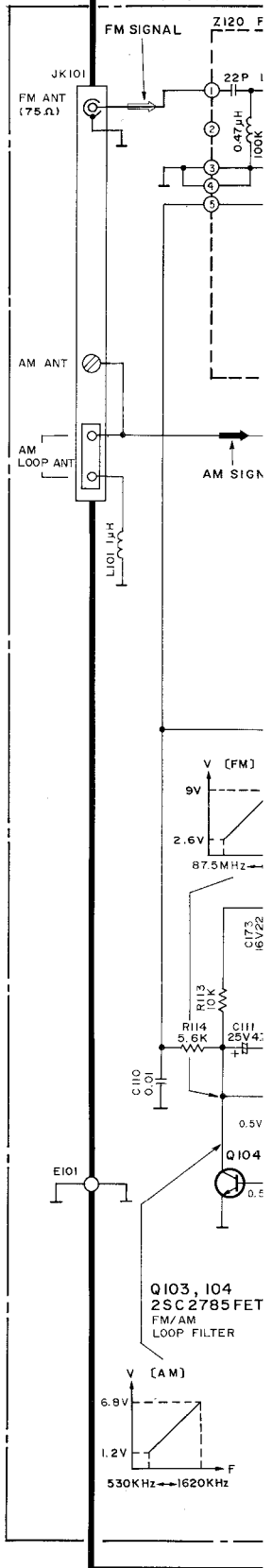
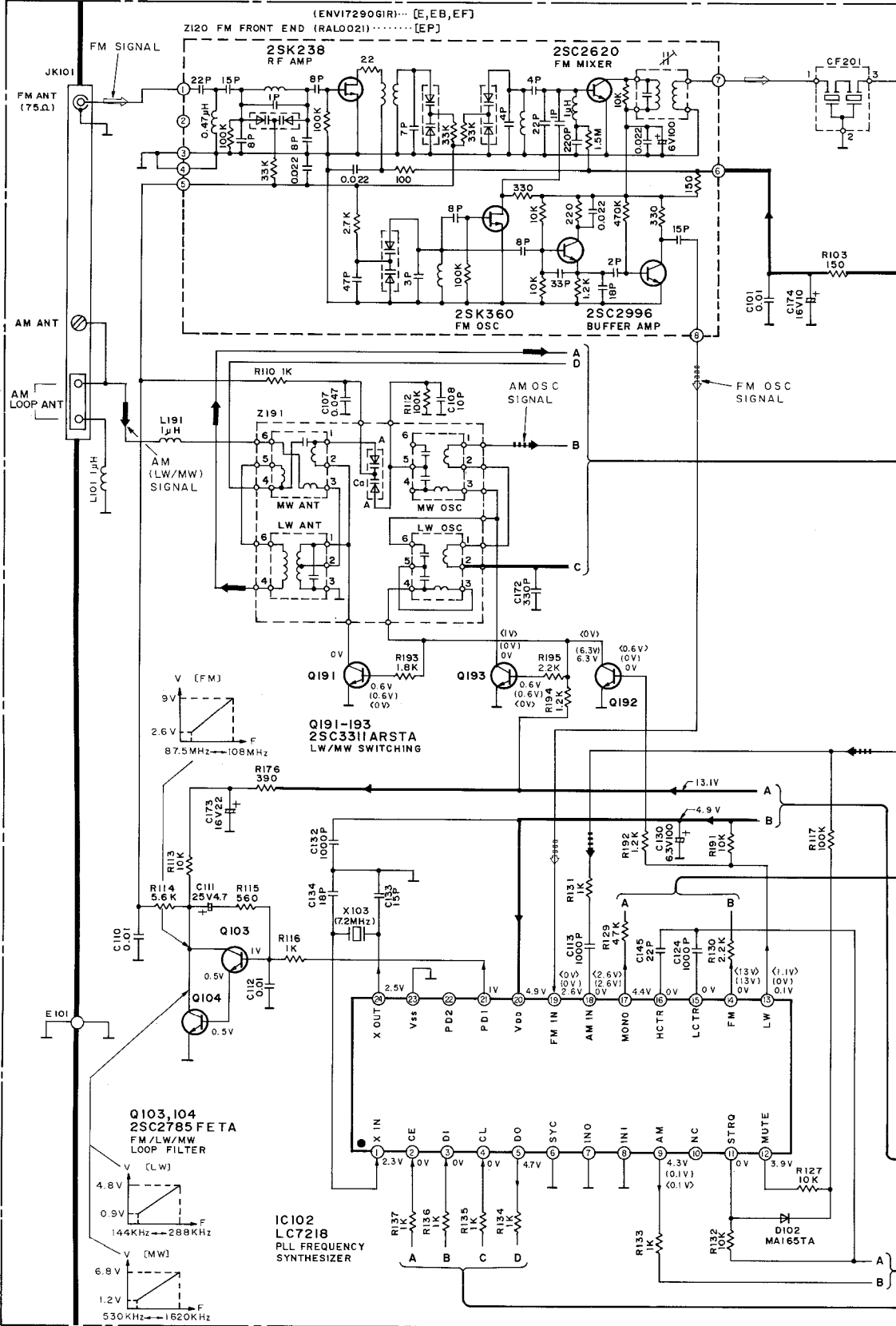

CIRCUIT (FM FRONT END/PLL/FM-AM IF AMP-DET-MPX/CONTROL/POWER SUPPLY/MUTING)

GC,GN]areas.

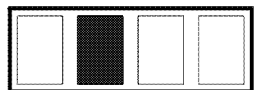
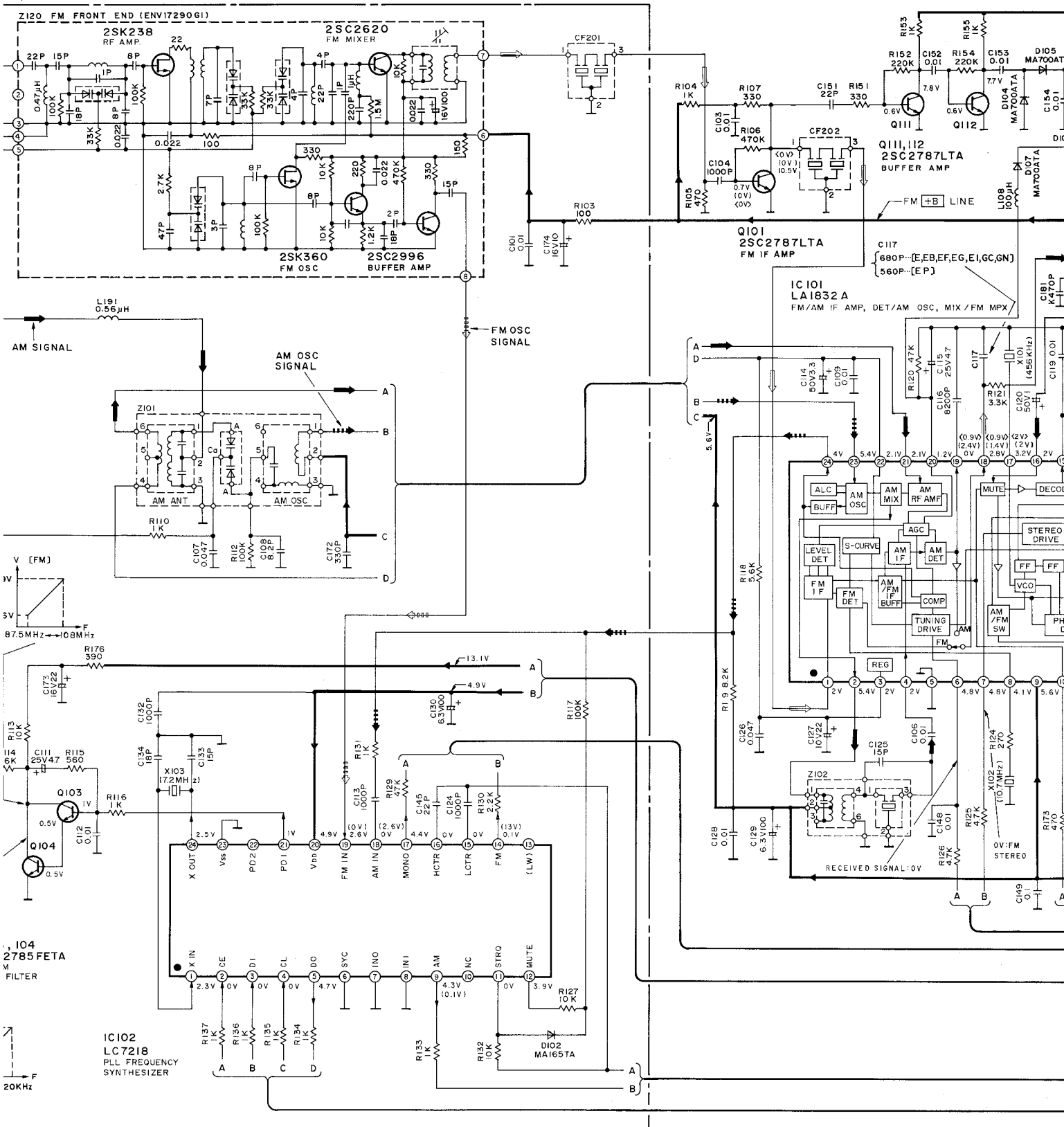

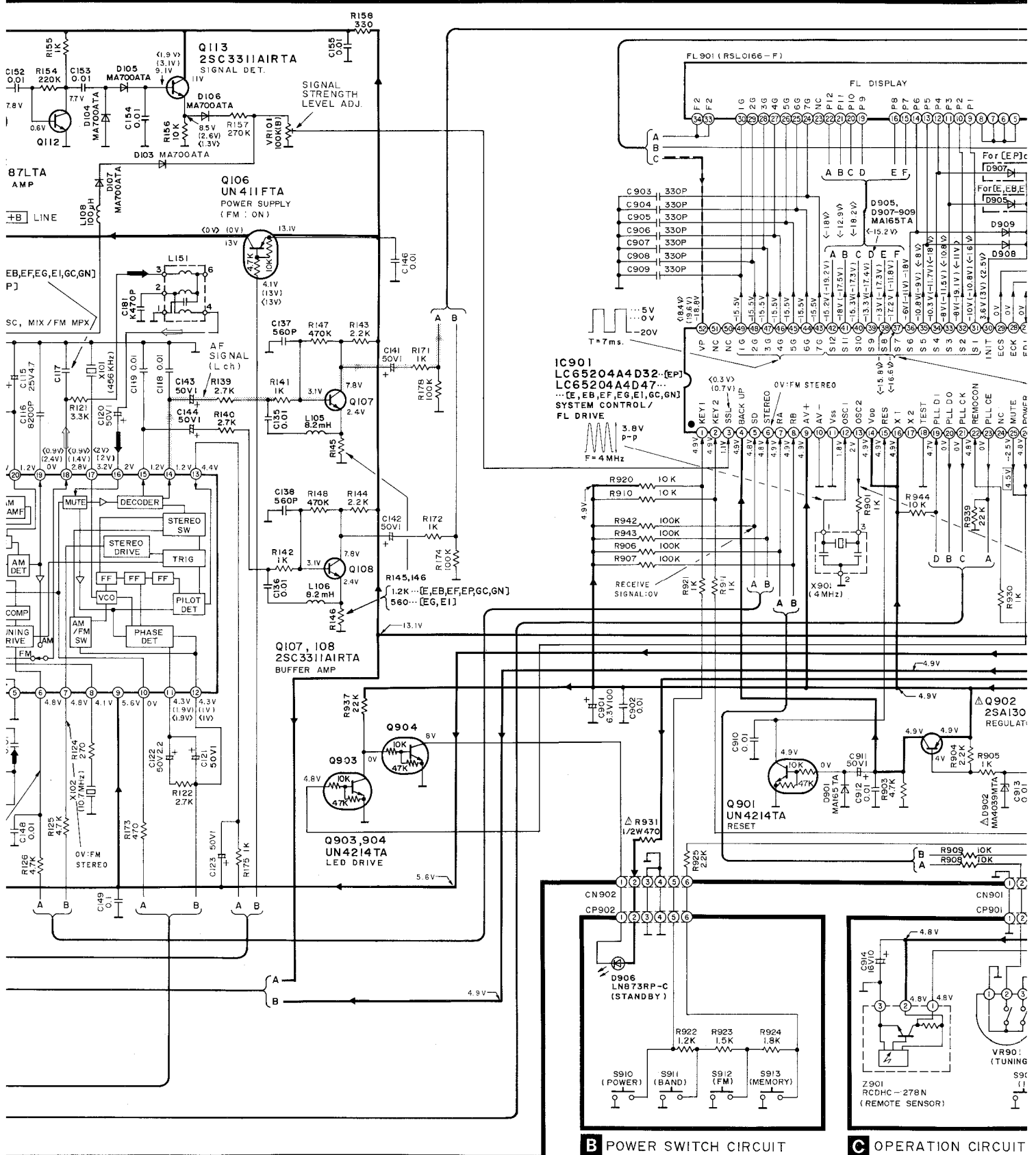

B POWER SWITCH CIRCUIT

C OPERATION CIRCUIT

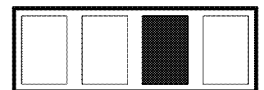

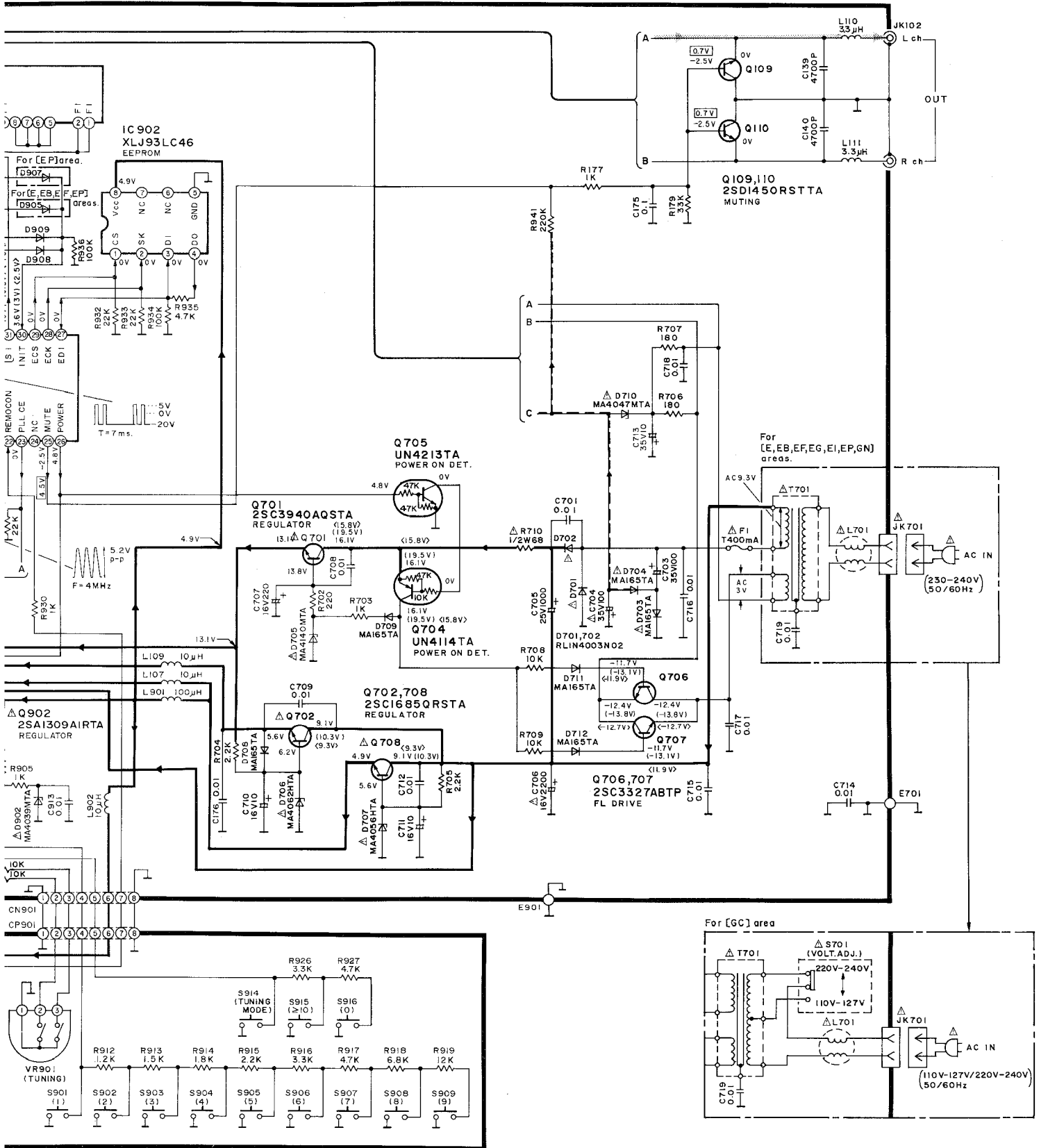

CIRCUIT

