

Service Manual

Stereo Integrated DC Amplifier

SU-V7

[D],[EG],[EW],[EK],[EF],
[EH],[EB],[XA],[XL]

SU-V7(K)

[D],[EG],[EW],[EH],
[EA],[XA]

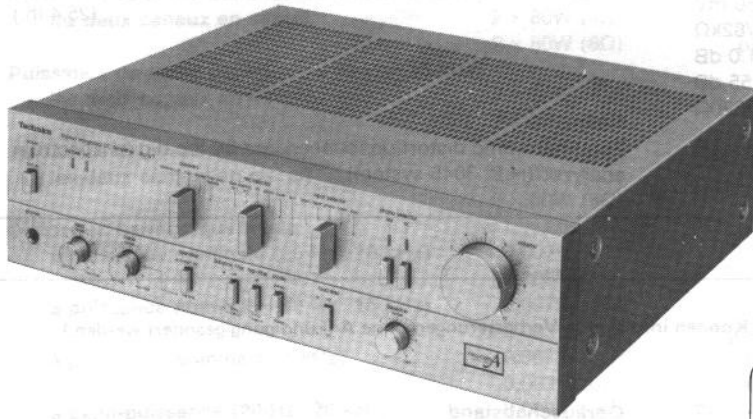

- * The cabinet and front panel are available in black color and silver types.
- * The black type model is provided with (K) in the Service Manual.

Areas

- * [D] is available in Scandinavia.
- * [EG] is available in F.R. Germany.
- * [EW] is available in Switzerland.
- * [EK] is available in United Kingdom.
- * [EF] is available in France.
- * [EH] is available in Holland.
- * [EB] is available in Belgium.
- * [EA] is available in Austria.
- * [XA] is available in East South Asia, Oceania, Africa, Middle Near East and Central South America.
- * [XL] is available in Australia.

English

Specifications

(Specifications are subject to change without notice for further improvement.)

(DIN 45 500)

■ AMPLIFIER SECTION

20 Hz~20 kHz continuous power output both channels driven	2 × 80W (4Ω) 2 × 80W (8Ω)
40 Hz~16 kHz continuous power output both channels driven	2 × 80W (4Ω) 2 × 80W (8Ω)
1 kHz continuous power output both channels driven	2 × 80W (4Ω) 2 × 80W (8Ω)
Total harmonic distortion	
rated power at 20 Hz~20 kHz	0.007% (4Ω) 0.003% (8Ω)
rated power at 40 Hz~16 kHz	0.007% (4Ω) 0.003% (8Ω)
rated power at 1 kHz	0.007% (4Ω) 0.003% (8Ω)
half power at 20 Hz~20 kHz	0.003% (8Ω)
half power at 1 kHz	0.003% (8Ω)
-26 dB power at 1 kHz	0.03% (4Ω)
50 mW power at 1 kHz	0.08% (4Ω)
Intermodulation distortion	
rated power at 250 Hz: 8 kHz=4:1, 4Ω	0.01%
rated power at 60 Hz: 7 kHz=4:1, SMPTE, 8Ω	0.007%
Power bandwidth both channels driven, -3 dB	5 Hz~70 kHz (4Ω THD 0.03%) 5 Hz~70 kHz (8Ω THD 0.02%)

Residual hum and noise	0.55 mV
Damping factor	20 (4Ω), 40 (8Ω)
Input sensitivity and impedance	
PHONO MM	2.5 mV/47kΩ
MC	170 μV/220Ω
TUNER, AUX	150 mV/27kΩ
TAPE 1 REC/PLAY	170 mV/25kΩ
TAPE 2	150 mV/27kΩ
PHONO maximum input voltage (1 kHz, RMS)	
MM	150 mV
MC	10 mV
S/N	
rated power (4Ω)	
PHONO MM	78 dB (IHF, A: 86dB)
MC	68 dB (IHF, A: 68dB)
TUNER, AUX	90 dB (IHF, A: 100 dB)
-26 dB power (4Ω)	
PHONO MM	67 dB
MC	65 dB
TUNER, AUX	68 dB
50 mW power (4Ω)	
PHONO MM	64 dB
MC	62 dB
TUNER, AUX	65 dB
Frequency response	
PHONO	RIAA standard curve ±0.5 dB (30 Hz~15 kHz) 0.5 Hz~170 kHz (-3 dB) +0 dB (20 Hz~20 kHz) -0.2 dB (20 Hz~20 kHz)
TUNER, AUX, TAPE	

Technics

Matsushita Electric Trading Co., Ltd.
P.O. Box 288, Central Osaka Japan

5. How to remove constant voltage SCR (D405, D407)

1. Remove the cabinet and bottom board.
2. Remove the setscrew ① (Fig. 18) used to secure the heat-sink of constant voltage SCR.
3. Remove the setscrew ② (Fig. 19) from the back of printed circuit board.
4. Unsolder D405 and D407.
5. Remove them along with heat-sink (Fig. 18).
6. Remove the setscrew ③ (Fig. 18) of press-board which presses D405 and D407 against the heat-sink.
7. When mounting them, remember to put on the mica plate coated with heat diffuser.

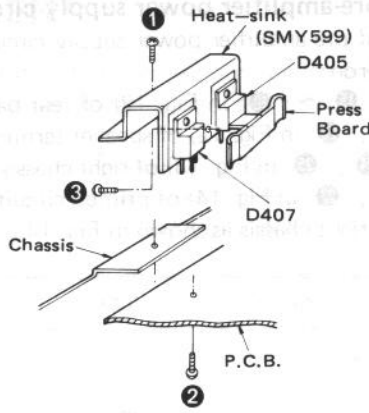

Fig. 18

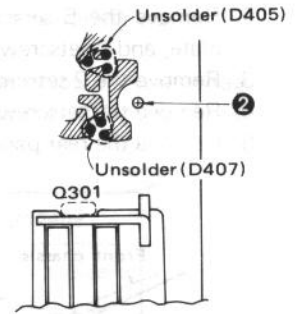

Fig. 19

Note: Setscrews ⑮ to ⑳ are screws with detents (Part No.: XTBS3+8BFZ1) as shown in Fig. 20-A in order to make the contact of electric circuit perfect. Take care not to mix up these screws with other screws. When substituting, use a 3 x 8mm tapping screw (Part No.: XTB3+8BFZ) and toothed lock washer (Part No.: XWC3B) as shown in Fig. 20-B. The teeth of the lock washer should be positioned on the chassis side.

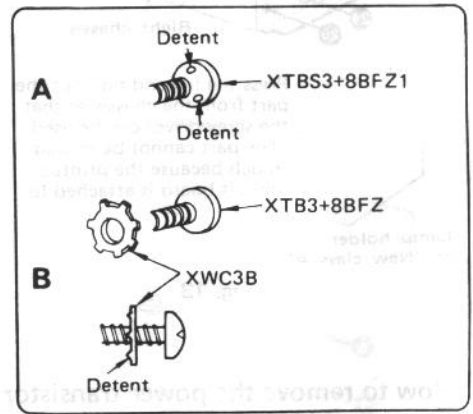

Fig. 20

ADJUSTMENT POINTS

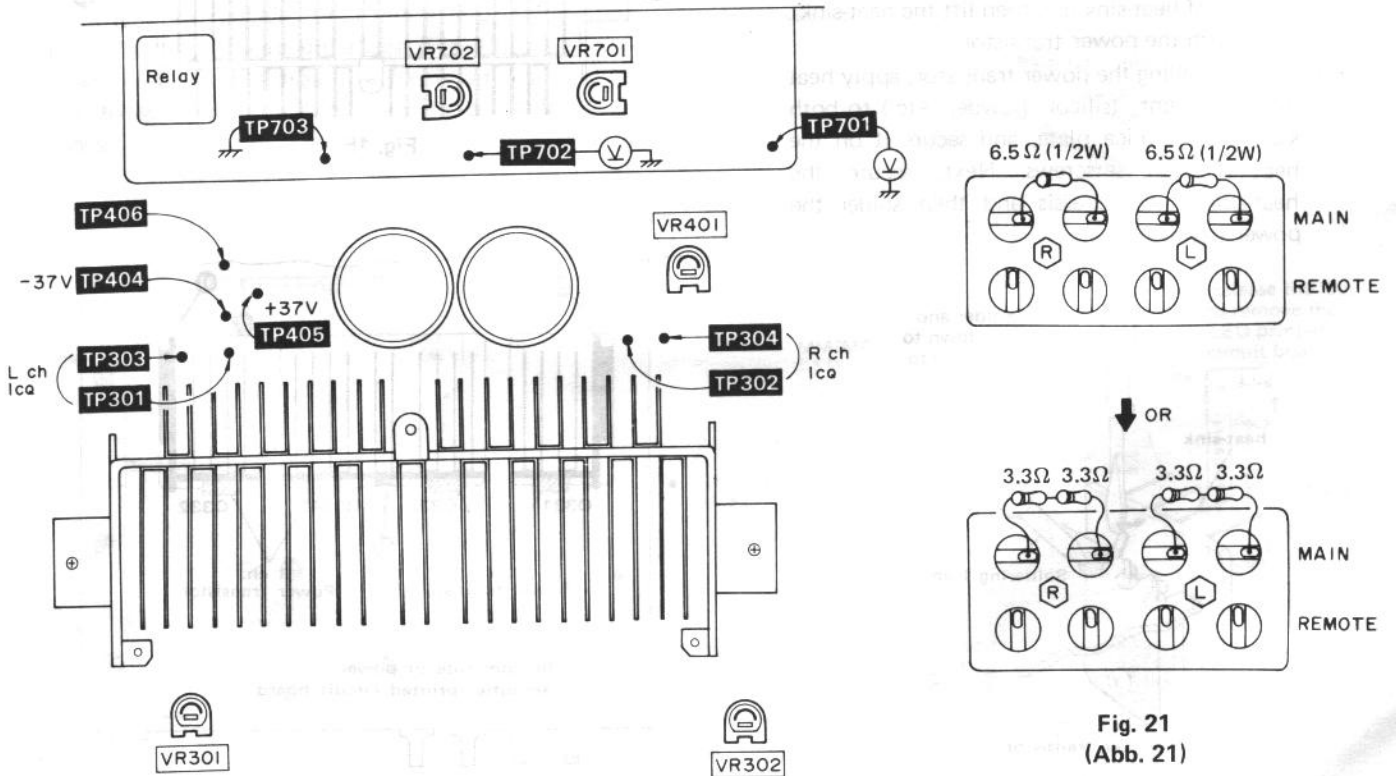

Fig. 21 (Abb. 21)

MEASUREMENTS AND ADJUSTMENTS — English

● **Setting and instruments used**

1. Operation switch straight DC
2. Speaker selector main
3. Sound volume 0 (minimum)
4. DC voltmeter (able to measure 4mV)
5. Instruments for circuit operation check
(AC voltmeter, 1kHz oscillator, 8Ω load, 5W 0.33Ω resistor, 1/2W 6.5Ω or 3.3Ω & 3.3Ω ±5%)

Item	Connection of DC voltmeter	VR adjusted	Adjustment													
Supply voltage adjustment & check	Connect voltmeter to TP405 (+) and TP406 (-). (TP406 serves as an ground point.) * Set the speaker selector to "main" when measuring the voltage. * If power supply of the set is ON, changing the load impedance will not cause alteration of supply voltage. So, turn off power supply or shift the speaker selector to other position. * With speaker selector set at main and remote, the voltage at 4 ~ 6Ω is indicated.	VR401	<ol style="list-style-type: none"> ① Connect 4Ω load to speaker terminal. ② Adjust VR401 so that the voltage is +37V. ③ Load resistances connected to speaker terminal and output voltage at each test point are shown below. <table border="1" style="width: 100%; border-collapse: collapse;"> <thead> <tr> <th>Load</th> <th>Test point</th> <th>Specification</th> </tr> </thead> <tbody> <tr> <td rowspan="2">4~6Ω</td> <td>TP405</td> <td>+36.5 ~ +37.5V</td> </tr> <tr> <td>TP404</td> <td>-36.7 ~ -37.7V</td> </tr> <tr> <td rowspan="2">8~16Ω</td> <td>TP405</td> <td>+45.5 ~ +47.5V</td> </tr> <tr> <td>TP404</td> <td>-45.5 ~ -47.5V</td> </tr> </tbody> </table>	Load	Test point	Specification	4~6Ω	TP405	+36.5 ~ +37.5V	TP404	-36.7 ~ -37.7V	8~16Ω	TP405	+45.5 ~ +47.5V	TP404	-45.5 ~ -47.5V
	Load			Test point	Specification											
4~6Ω	TP405	+36.5 ~ +37.5V														
	TP404	-36.7 ~ -37.7V														
8~16Ω	TP405	+45.5 ~ +47.5V														
	TP404	-45.5 ~ -47.5V														
Adjustment of ICQ	L channel Connect voltmeter to TP301 (-) and TP303 (+)	VR301	<ol style="list-style-type: none"> ① Completely turn VR301 and VR302 anticlockwise beforehand. ② Adjust VR301 (L channel) and VR302 (R channel) so that the voltage is 2mV, about 10 min. after power supply ON. 													
	R channel Connect voltmeter to TP302 (-) and TP304 (+)	VR302														

● **Adjustment of load impedance detection circuit**

- ① Connect a load with 6.5Ω (1/2W carbon resistor) or series-connected 3.3Ω and 3.3Ω (1/2W, ±5%) to the "main" speaker terminal, (Fig. 21)
- ② Connect a DC voltmeter between TP701 and chassis, TP702 and chassis.
- ③ Connect TP703 and chassis.
- ④ Completely turn VR701 clockwise.
- ⑤ Adjust VR702 so that the voltage of TP702 is -0.1V.
- ⑥ Adjust VR701 so that the voltage of TP701 is 0V.

● **Check points**

1. DC balance

- ① Make the sound volume minimum.
- ② Connect DC voltmeter and 8Ω load to speaker terminal.
- ③ Make sure that output voltage is within ±30mV.

2. Protection circuit

- ① Connect AC voltmeter and 8Ω load to speaker terminal.
- ② Make the sound volume maximum.
- ③ Apply 1 kHz 100mV signal to "TUNER" terminal.
- ④ Turn on power supply and make sure that output is delivered about 4 ~ 8 sec. later.
- ⑤ Apply ±150mV DC to "TUNER" terminal of L and R channels in order.
- ⑥ Make sure that relay in the set turns OFF immediately when DC is applied.

* If protection relay turns OFF due to overload, the circuit and load will not restore their normal conditions unless power supply is once turned OFF and again turned ON.

3. Overload detection circuit

- ① Connect 8Ω load to "main" speaker terminal and 5W 0.33Ω resistance to "remote" speaker terminal.
- ② Apply 1kHz 40mV signal to "TUNER" terminal.
- ③ Make the sound volume maximum.
- ④ With speaker selector set at main and remote, make sure that relay in the set is OFF and no output is delivered.

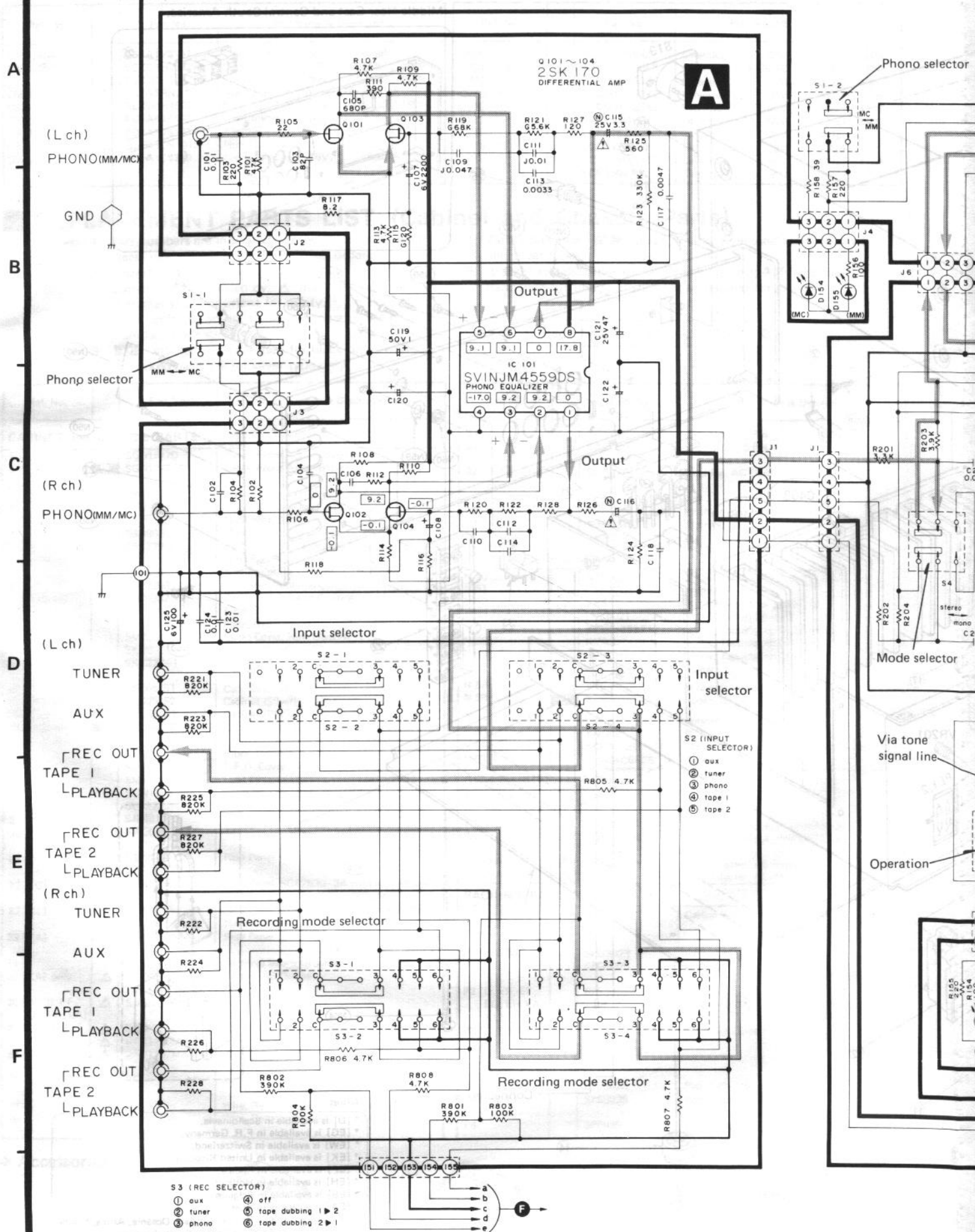

A
B
C
D
E
F
G

(L ch)
PHONO(MM/MC)

(R ch)
PHONO(MM/MC)

(L ch)
TUNER
AUX
REC OUT TAPE 1
PLAYBACK

(R ch)
TUNER
AUX
REC OUT TAPE 1
PLAYBACK
REC OUT TAPE 2
PLAYBACK

S3 (REC SELECTOR)
 ① aux ④ off
 ② tuner ⑤ tape dubbing 1 ▶ 2
 ③ phono ⑥ tape dubbing 2 ▶ 1

S2 (INPUT SELECTOR)
 ① aux
 ② tuner
 ③ phono
 ④ tape 1
 ⑤ tape 2

Phono selector

Phono selector

Mode selector

Via tone signal line

Operation

EXPLODED VIEW

C

B

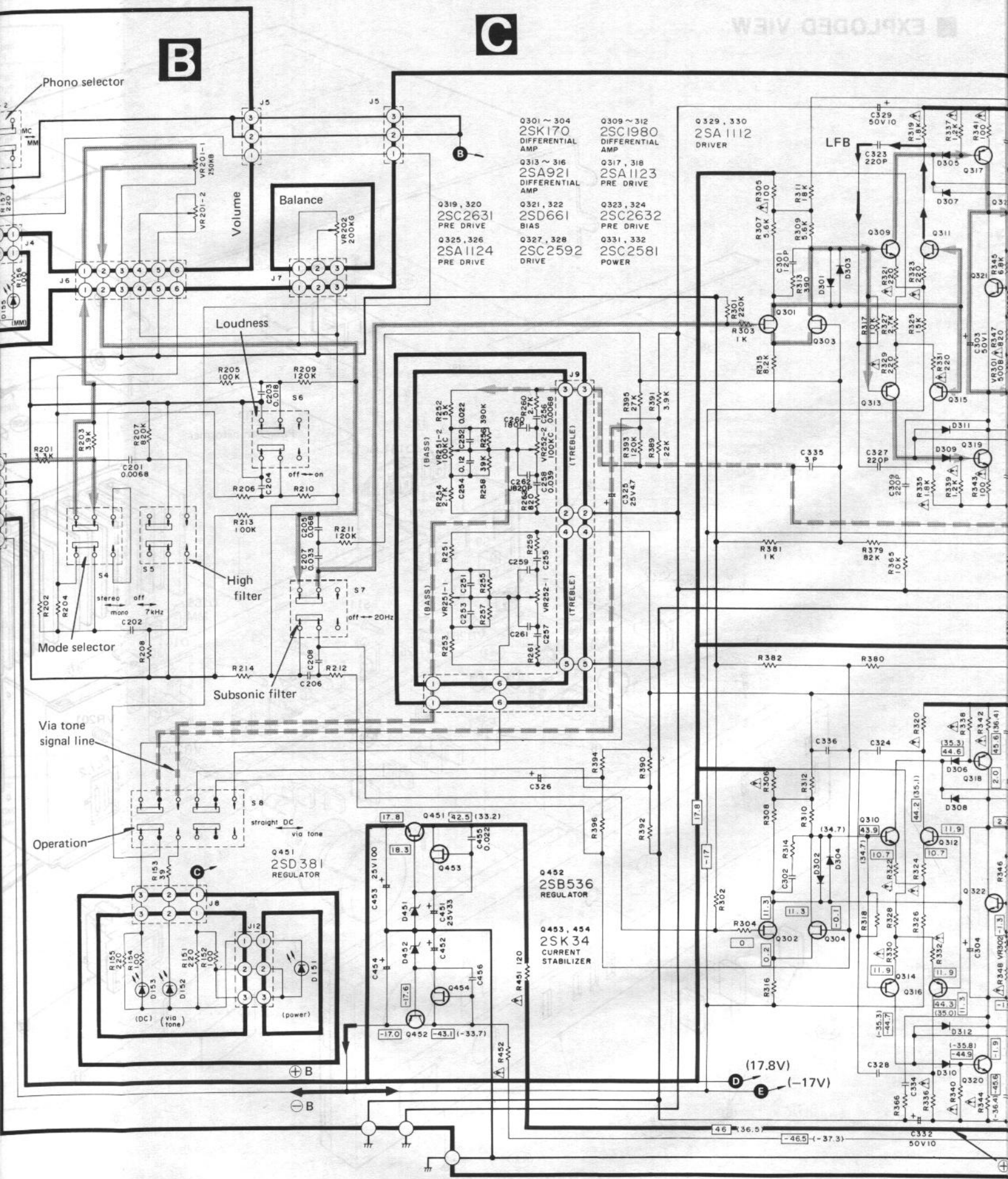

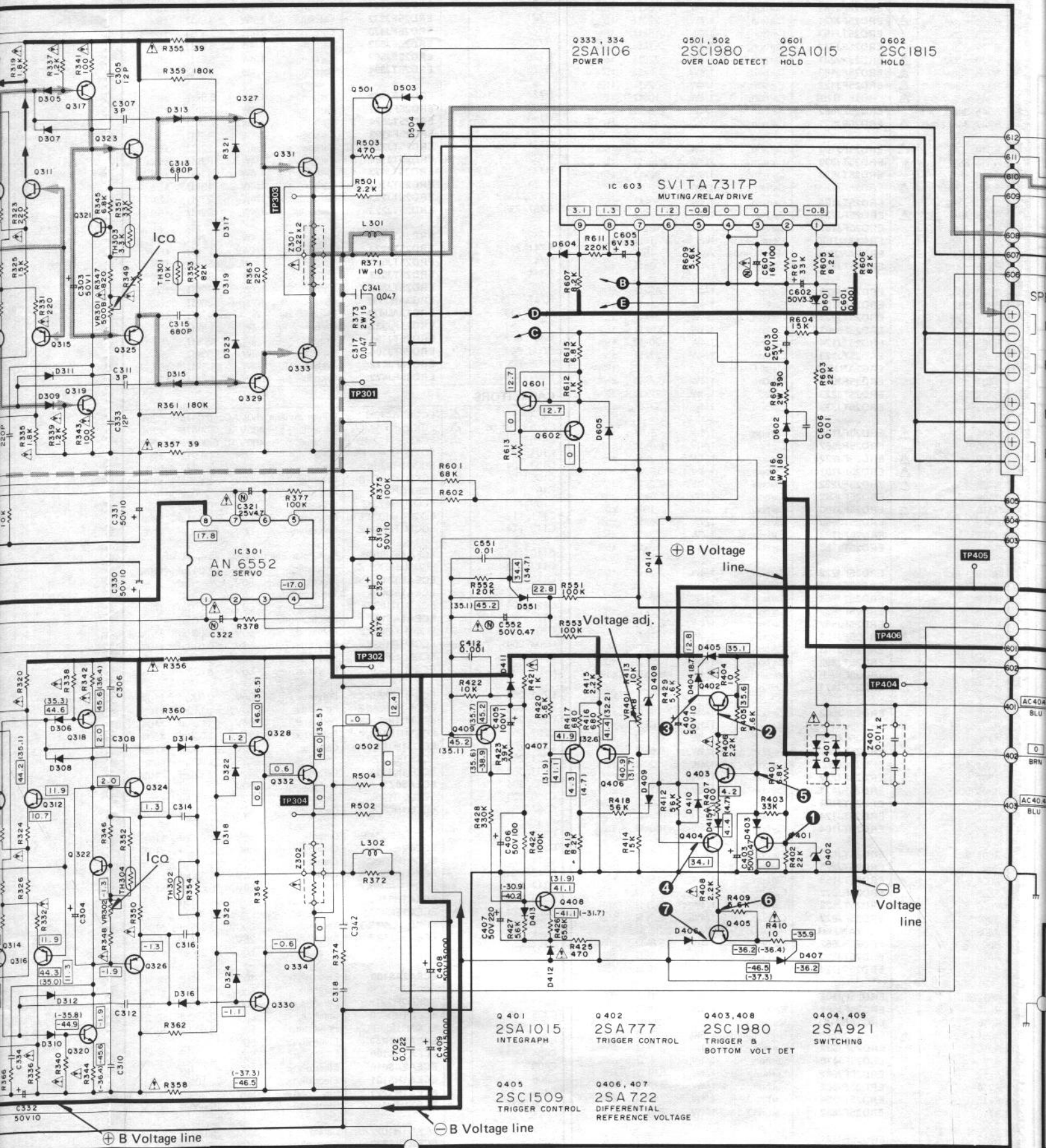

2SC1815 HOLD

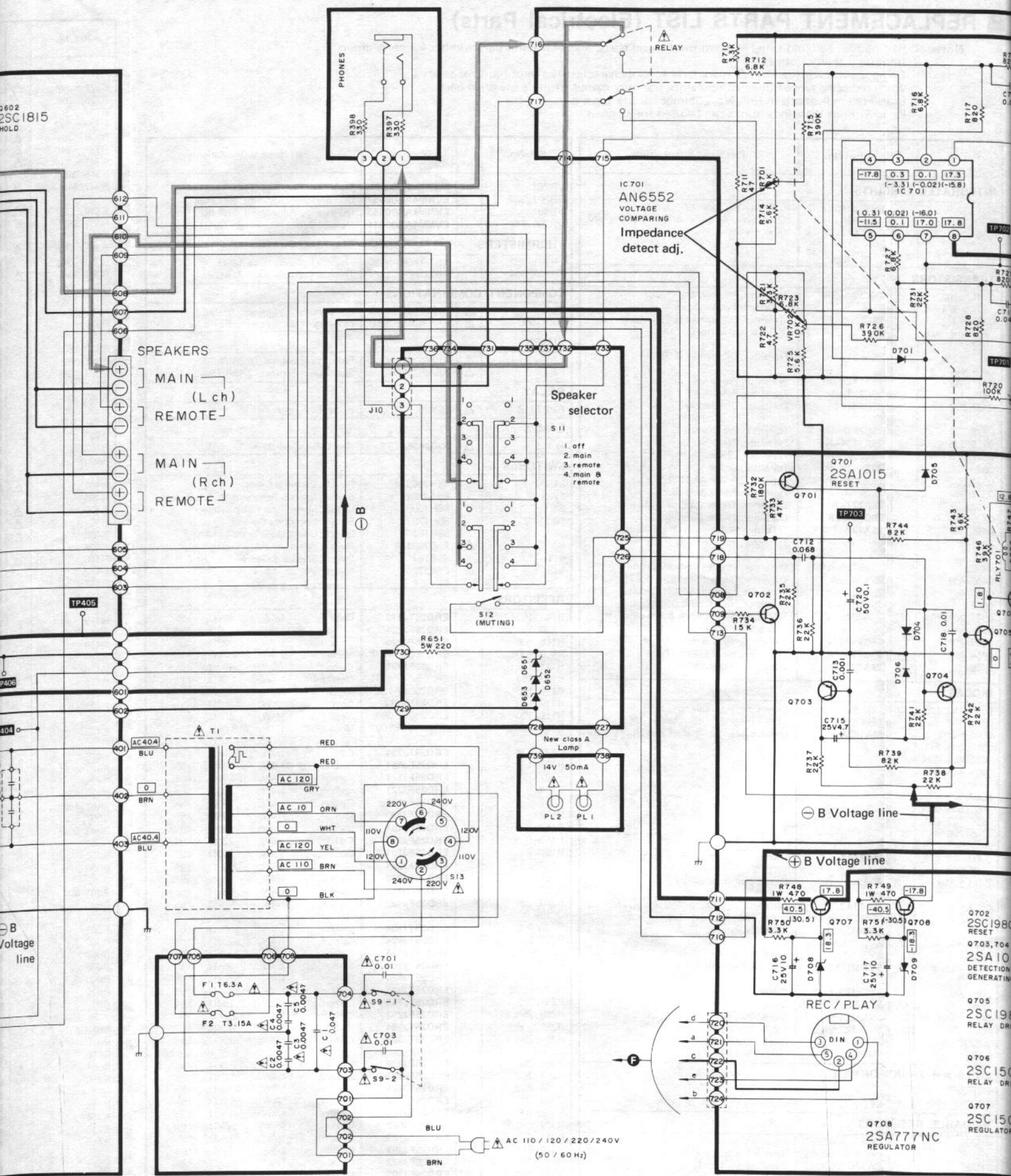

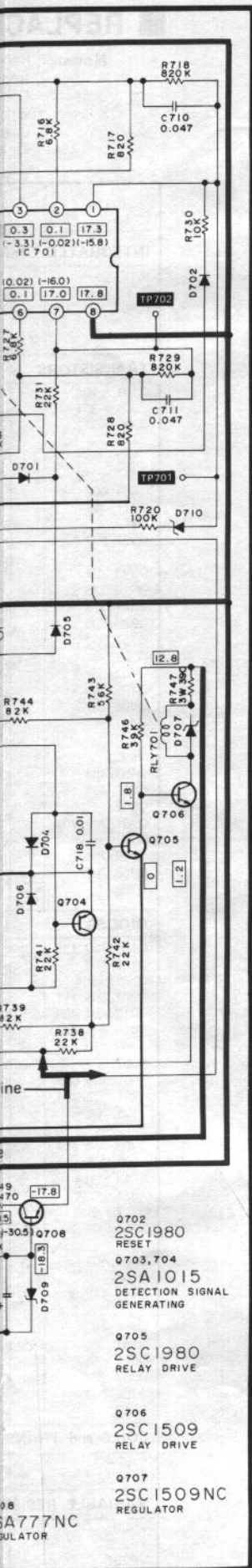

D

Notes:

- S1-1, S1-2:** MM/MC cartridge (phono) selector switch in "MM" position.
- S2-1, S2-4:** Input selector switch in "phono" position. (① aux ↔ ② tuner ↔ ③ phono ↔ ④ tape 1 ↔ ⑤ tape 2)
- S3-1~S3-4:** Recording output selector switch in "phono" position. (① aux ↔ ② tuner ↔ ③ phono ↔ ④) off ↔ ⑤ tape dubbing 1 ↔ ⑥ tape dubbing 2) 1)
- S4:** Mode switch in "stereo" position.
- S5:** High filter switch in "off" position. (off ↔ 7kHz, -6dB/oct.)
- S6:** Loudness switch in "off" position.
- S7:** Subsonic filter switch in "off" position (off ↔ 20Hz, -12dB/oct.)
- S8:** Operation switch in "straight DC" position (straight DC ↔ via tone)
- S9-1, S9-2:** Power source switch in "on" position.
- S11, S12:** Speakers selector switch in "main" position. (① off ↔ ② main ↔ ③ remote ↔ ④ main and remote)
- S13:** Voltage selector switch in "220V" position. (120V ↔ 110V ↔ 220V ↔ 240V)
- Same circuit is used for both L and R channels. For the resistance and capacity of R channel (bottom of circuit diagram), refer to L channel. For the voltage value, refer to R channel.
- Indicated voltage values are the standard values for the DC electronic circuit tester (high impedance) with the chassis taken as standard. Therefore, there may exist some errors in the voltage values, depending on the internal impedance of the DC circuit tester.
 - * The voltage values in are those obtained with speaker selector set at "main" and load impedance at "8Ω".
 - * The parenthesized voltage values are those obtained with speaker selector at "main" and load impedance at "4Ω". (Same voltage values are indicated with speaker selector set at "main and remote" or with heat sensing SCR D551 turned ON.)
- Phono signal lines of left channel
- Positive (+B) voltage lines.
- Important safety notice:
Components identified by Δ mark have special characteristics important for safety. When replacing any of these components, use only manufacturer's specified parts.

● Part number of diodes

Diode Ref. No.	Production Part No.	Standardized Part No.
D151, 153, 155	LN820WP	
D152, 154	LN420WP	
D301 ~ 304	MA150	MA162
D305, 306, 309, 310	SVDMA26-1	MA27A1
D307, 308, 311, 312	MA162A	
D313 ~ 316, 321~324	OA90	2-OA90
D317 ~ 320	SVDMA26-2	MA27A2
D401	SVDS10VB20F	
D402	SVDMZ320B	
D403, 409, 410, 415	MA150	MA162A
D405, 407	SVDCR6AM-2	
D408	SVDMZ306	
D404, 406, 414	MA162	MA162A
D411, 412	SVDSR1K2	
D413	SVDMA26-1	MA27A1
D451, 452	SVDMZ318A2	
D503, 504	MA162	MA162A
D551	SVTTT201-90	
D601, 604, 605	MA150	MA162A
D602	SVDSR1K2	
D603	SVDMZ422B	
D651 ~ 653	SVDMZ409B	
D701 ~ 706	MA150	MA162A
D707	SVDMZ322	
D708, 709	SVDMZ318	
D710	SVDMZ339	