

Service Manual

Stereo Integrated Amplifier

Amplifier

SU-X840

Color

(K) Black Type



Color	Areas
(K)	[EX] Continental Europe
(K)	[EH] Holland
(K)	[EB] Belgium
(K)	[EF] France
(K)	[EK] United Kingdom
(K)	[EG] F.R. Germany
(K)	[EW] Switzerland
(K)	[Ei] Italy
(K)	[XL] Australia
(K)	[XA] Asia, Latin America, Middle Near East, Africa & Oceania
(K)	[PA] East PX.
(K)	[PE] European Military
(K)	[XB] Saudi Arabia

SPECIFICATIONS (DIN 45 500)

■ AMPLIFIER SECTION

DIN power output	
1 kHz THD: 1%	2 × 50W (8Ω)
Total harmonic distortion	
rated power at 1 kHz	1% (8Ω)
half power at 1 kHz	0.009% (8Ω)
Residual hum and noise	0.4 mV
Damping factor	30 (8Ω)
Input sensitivity and impedance	
PHONO	3 mV/47kΩ
TUNER, CD, AUX, TAPE 1, TAPE 2	200 mV/22kΩ
MIC	1.2 mV/10kΩ
Maximum input voltage (1 kHz, RMS)	
PHONO	120 mV
MIC	40 mV
S/N (rated power 8Ω)	
PHONO	73 dB (IHF, A, 79 dB)

TUNER, CD, AUX, TAPE 1, TAPE 2

	84 dB (IHF, A: 83 dB)
Frequency response	
PHONO	RIAA standard curve ±0.8 dB (30 Hz~15 kHz)
TUNER, CD, AUX, TAPE 1, TAPE 2	10 Hz~50 kHz (-3 dB)
Tone controls	
BASS	50 Hz, +10 dB, -10 dB
TREBLE	20 kHz, +10 dB, -10 dB
Muting	-20 dB
Super bass	70 Hz, +10 dB
Output voltage	
TAPE 1, TAPE 2, REC OUT	200 mV
Channel balance, AUX 250 Hz~6,300 Hz	±1.0 dB
Channel separation, AUX 1 kHz	60 dB
Headphones output level and impedance	435 mV/340Ω

Load impedance

MAIN	8Ω~16Ω
SURROUND	8Ω~16Ω
■ GENERAL	
Power consumption	230W
Power supply	
For continental Europe	AC 50 Hz/60 Hz, 220V
For others	AC 50 Hz/60 Hz, 110V/127V/220V/240V
Dimensions (W×H×D)	360 × 103 × 300 mm (14-3/16" × 4-1/16" × 11-13/16")
Weight	5.0 kg (11 lb.)

Notes:

- Specifications are subject to change without notice.
Weight and dimensions are approximate.
- Total harmonic distortion is measured by the digital spectrum analyzer (H.P. 3045 system).

Specifications are subject to change without notice for further improvement.

■ CONTENTS

	Page
LOCATION OF CONTROLS	2
CONNECTION	3
ACCESSORY	3
PROTECTION CIRCUITRY	3
BEFORE REPAIR AND ADJUSTMENT	3
DISASSEMBLY INSTRUCTIONS	4, 5
FUNCTION OF IC TERMINALS	5, 6

	Page
BLOCK DIAGRAM	7, 8
RESISTORS & CAPACITORS	9, 10
CIRCUIT BOARDS AND WIRING	
CONNECTION DIAGRAM	11 ~ 15
SCHEMATIC DIAGRAM	16 ~ 21
REPLACEMENT PARTS LIST	23, 24
EXPLODED VIEW	25, 26

Technics

Matsushita Electric Trading Co., Ltd.
P.O. Box 288, Central Osaka Japan

Panasonic Tokyo Office
Matsushita Electric Trading Co., Ltd.
6th Floor, World Trade Center Bldg.,
No. 4-1, Hamamatsu-cho 2-Chome, Minato-ku,
Tokyo 105, Japan

LOCATION OF CONTROLS

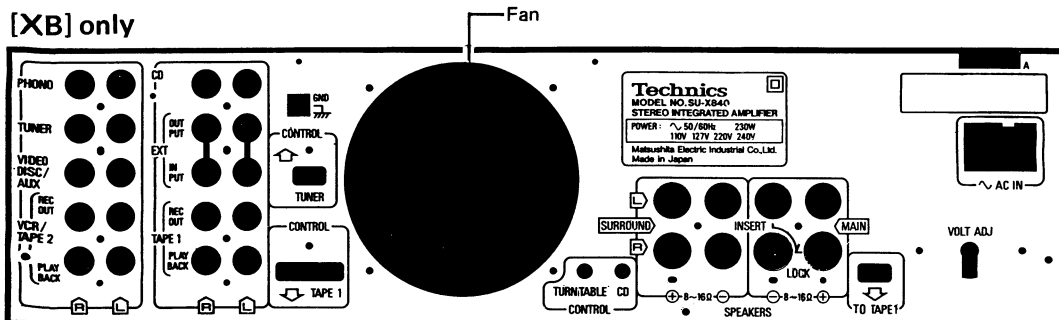
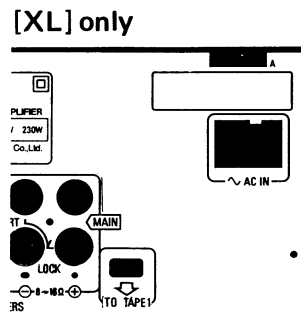
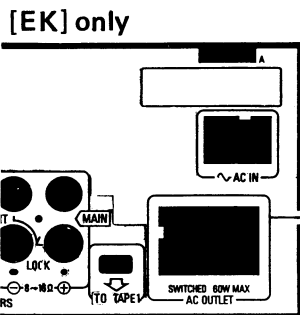
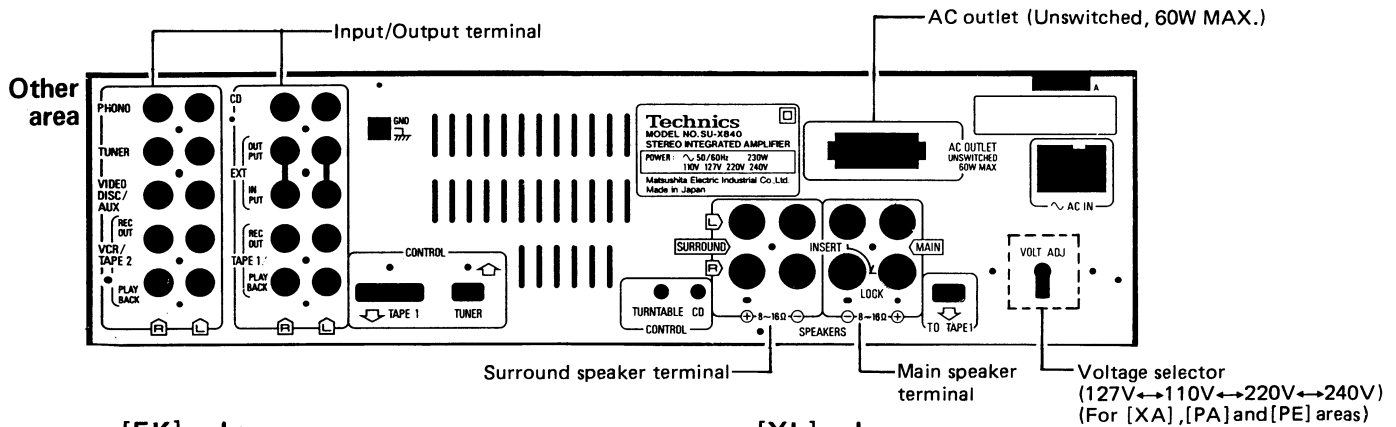
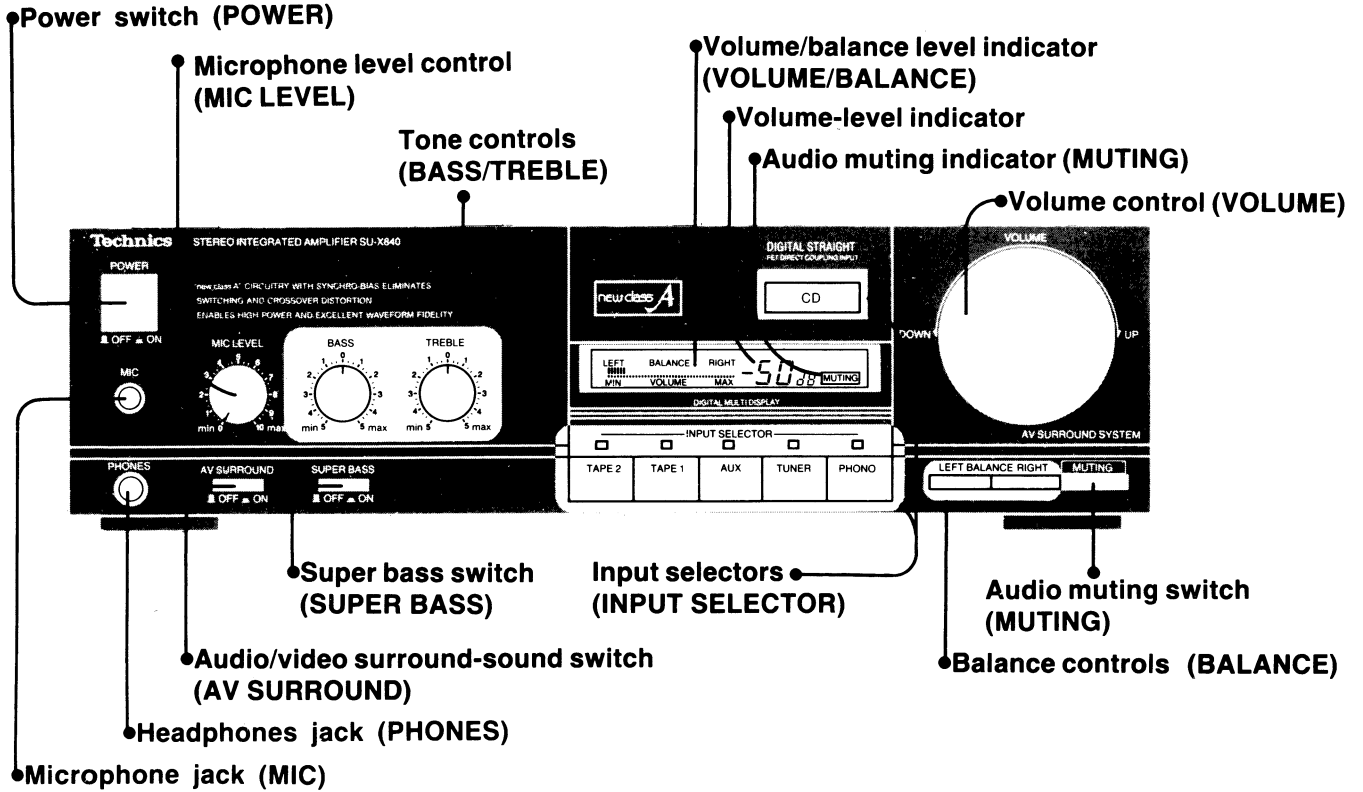

DISASSEMBLY INSTRUCTIONS

"ATTENTION SERVICER"

SOME CHASSIS COMPONENTS MAY HAVE SHARP EDGES. BE CAREFUL WHEN DISASSEMBLING AND SERVICING.

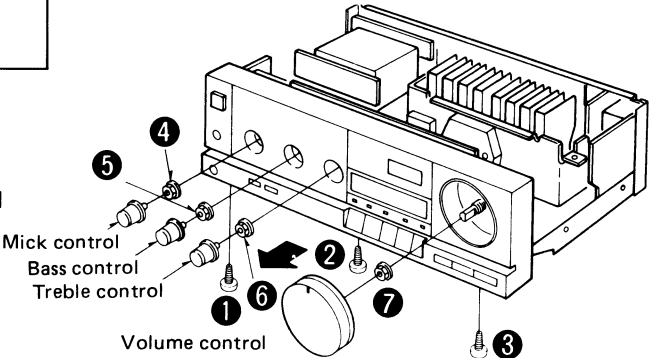
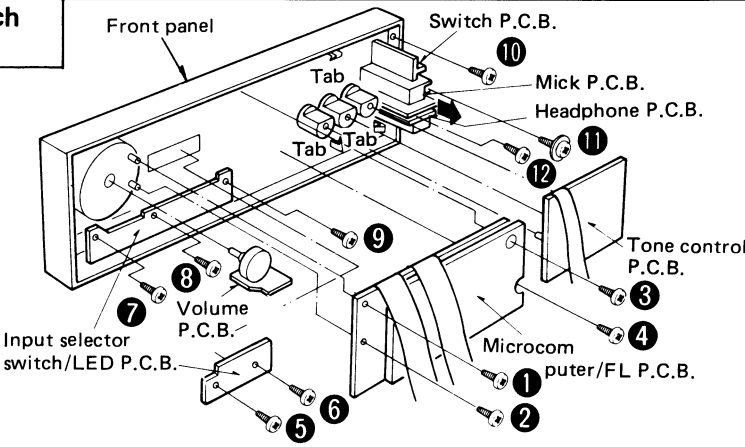
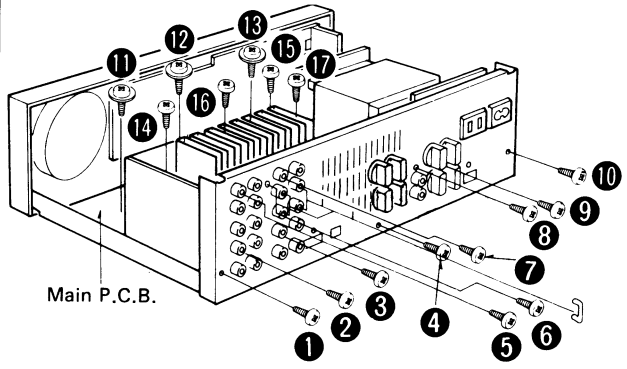
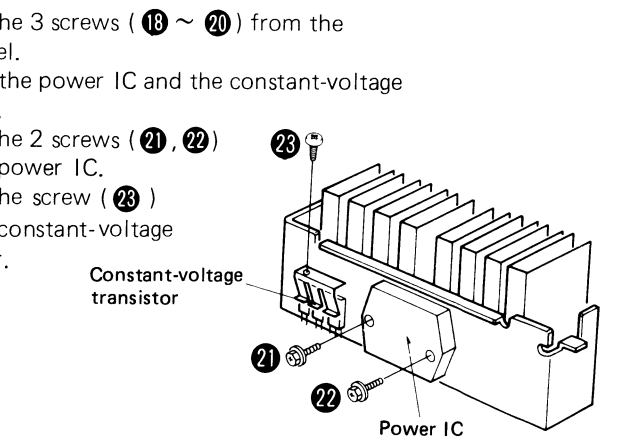
Ref. No. 1	How to remove the cabinet	
Procedure 1	1. Remove the 4 screws from both sides of the cabinet and the 2 screws from its back.	
Ref. No. 2	How to remove the front panel	
Procedure 1 → 2		
1. Remove the 3 screws (① ~ ③) from the front panel. 2. Remove the 4 controls-volume, mike, treble and bass-and their respective nuts (④ ~ ⑦).		
Ref. No. 3	How to remove the input selector switch and microcomputer FL P.C.B.	
Procedure 1 → 2 → 3		
1. Remove the 4 screws (① ~ ④) from the microcomputer/FL P.C.B. 2. Remove the 5 screws (⑤ ~ ⑨) from the input selector switch/LED P.C.B. 3. Undo the tabs off the tone control P.C.B. 4. Remove the screw (⑩) from the switch P.C.B. 5. Remove the screw (⑪) from the mike P.C.B. 6. Remove the screw (⑫) from the headphone P.C.B.		
Ref. No. 4	How to remove the power IC and constant-voltage transistor	
Procedure 1 → 4		
1. Remove the 10 screws (① ~ ⑩) from the rear panel. 2. Remove the 5 screws (⑪ ~ ⑮) from the main P.C.B. 3. Remove the 2 screws (⑯, ⑰) from the heat sink.		
8. When mounting the power IC and the constant-voltage transistor, apply silicone grease (SZ0GYG6260) over their contact areas.		

Ref. No.
5

How to remove the cooling fan motor

Procedure
1 → 5

[XB] only

1. Remove the 4 screws (① ~ ④) and the connector.

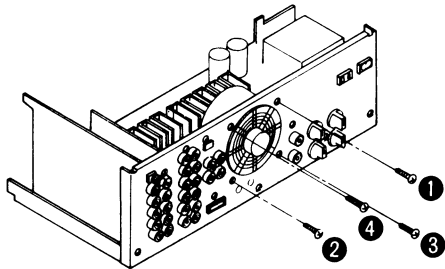

3. Remove the motor cover.

4. Remove the motor from the fan casing.

5. When mounting the fan motor, align the fan casing's projection with the hole of the fan motor.

2. Insert a screwdriver at the root of the cooling fan it out of the motor shaft.

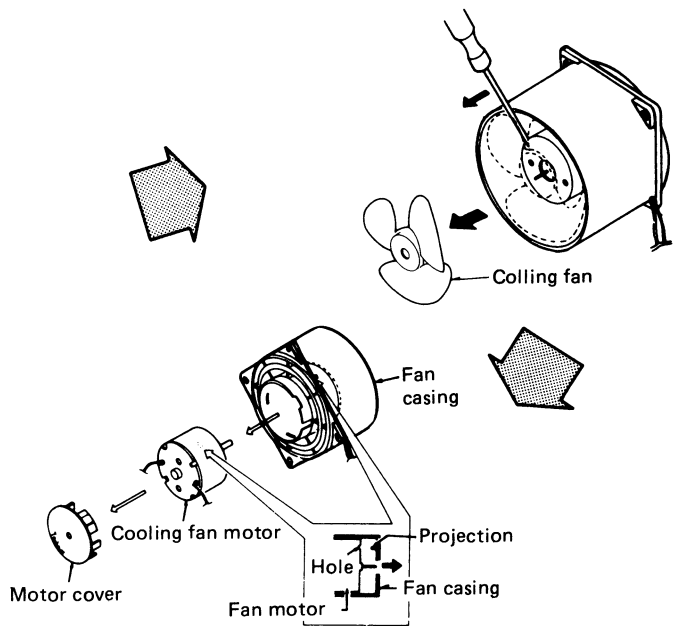

FUNCTION OF TERMINAL

● IC601 (LC6554D-3230)

Pin No.	Symbol	Function Description																							
1	G0	Grid drive output for digital multi-display (FL).																							
3	3																								
4	G3																								
5	S0	Key matrix output.	<table border="1"> <thead> <tr> <th>Output Input</th> <th>5</th> <th>6</th> <th>7</th> </tr> </thead> <tbody> <tr> <td>10</td> <td>S603 VIDEO DISC/AUX</td> <td>S612 MUTE</td> <td>S608 BALANCE(R)</td> </tr> <tr> <td>11</td> <td>—</td> <td>—</td> <td>S607 BALANCE(L)</td> </tr> <tr> <td>12</td> <td>S602 TUNER</td> <td>S605 VTR/TAPE 2</td> <td>—</td> </tr> <tr> <td>13</td> <td>S601 PHONO</td> <td>S604 TAPE 1</td> <td>—</td> </tr> </tbody> </table>			Output Input	5	6	7	10	S603 VIDEO DISC/AUX	S612 MUTE	S608 BALANCE(R)	11	—	—	S607 BALANCE(L)	12	S602 TUNER	S605 VTR/TAPE 2	—	13	S601 PHONO	S604 TAPE 1	—
Output Input	5		6	7																					
10	S603 VIDEO DISC/AUX	S612 MUTE	S608 BALANCE(R)																						
11	—	—	S607 BALANCE(L)																						
12	S602 TUNER	S605 VTR/TAPE 2	—																						
13	S601 PHONO	S604 TAPE 1	—																						
7	S2																								
10	K0	Key matrix input.																							
13	K3																								
8	S3	Not used.																							
9	POWER ON	Not used.																							
14	VR0	Rotary encoder input of volume control (VR601).																							
15	VR1																								
16	CS0	Not used.																							
17	HALT	Input for power detection.																							
18	CS1	Not used.																							
19	AMP	Input for power detection.																							
20	AMP POWER	Not used.																							

Pin. No.	Symbol	Function Description	
21	$\overline{\text{CUT}}$	Input selector noise cut muting output.	
22	$\overline{\text{S. ON}}$	Not used.	
23	$\overline{\text{DTS}}$	Not used.	
24	$\overline{\text{LVTR}}$	LED selector display (VTR) output.	
25	$\overline{\text{LTA}}$	LED selector display (TAPE) output.	
26	$\overline{\text{LVD}}$	LED selector display (VIDEO DISC/AUX) output.	
27	$\overline{\text{LCD}}$	LED selector display (CD) output.	
28	$\overline{\text{LTU}}$	LED selector display (TUNER) output.	
29	$\overline{\text{LPH}}$	LED selector display (PHONO) output.	
30	TEST	Not used.	
31	V _{SS}	Grounding.	
32	OSC1	Clock oscillation input/output.	
33	OSC2		
34	$\overline{\text{RES}}$	Reset signal input.	
35	ST	ST signal control output	
36	DATA	DATA signal control output.	
37	CK	CK signal control output.	
38	$\overline{\text{REM}}$	Remote control data input.	
39	$\overline{\text{DCD}}$	Deck control output.	
40	$\overline{\text{SID}}$	ST, CK and DATA signal control.	
41	$\overline{\text{SYPH}}$	Player synchronized recording input.	
42	$\overline{\text{SYCD}}$	CD synchronized recording input.	
43	SY OUT	Deck synchronized recording output.	
44	$\overline{\text{START}}$	Player STOP/START signal output.	
45	$\overline{\text{STOP}}$		
46	$\overline{\text{REC}}$	Deck on-recording signal input.	
47	$\overline{\text{PH}}$	Input selection by phono unit signal.	Direct operation input.
48	$\overline{\text{TU}}$	Input selection by tuner unit signal.	
49	$\overline{\text{CD}}$	Input selection by CD unit signal.	
50	$\overline{\text{DECK}}$	Input selection by tape unit signal.	
51	V _P	Power supply.	
52 , 60	S0 , S8	Digital multi-display (FL) output.	
61	S music	Not used.	
62	S movie		
63	S mono		
64	V _{DD}	Power supply.	

BLOCK DIAGRAM

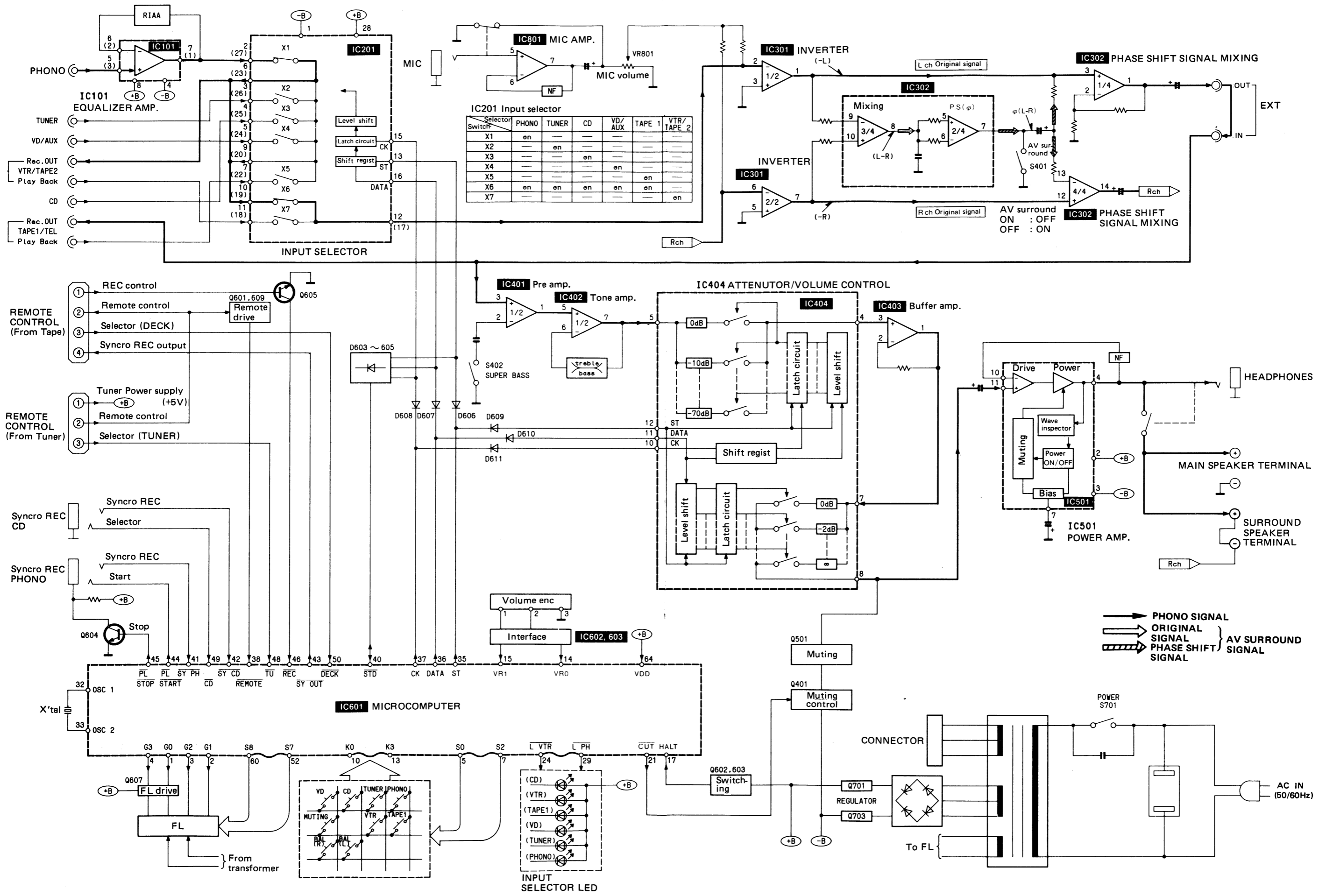

RESIS

Notes: * Important Component characteristics these components. * Bracketed area. Parts with

Numbering System

Example

ERD	25
Type	Wattage

ERX	2
Type	Wattage

Numbering System

Example

ECKD	1H
Type	Voltage

ECEA	50
Type	Voltage

Ref. No.	
RESISTORS	
C513	E
R101, R102	E
R103, R104	E
R105, R106	E
R107, R108	E
R109, R110	E
R111, R112	E
R113, R114	E
R115, R116	E
R117, R118	E
R119, R120(EG)	E
R201, R202	E
R203	E
R204, R205	E
R206	E
R207, R208	E
(EG)	E
R209, R210	E
(EG)	E
R211, R212	E
(EG)	E
R213, R214	E
(EG)	E
R215, R216	E
(EG)	E
R217, R218	E
(EG)	E
R219, R220	E
(EG)	E
R221, R222	E
(EG)	E
R223, R224	E
(EG)	E
R301, R302	E
R303, R304	E
R305, R306	E
R307, R308	E
R309, R310	E
R311, R312	E
R313, R314	E
R315, R316	E

RESISTORS & CAPACITORS

Notes: * Important safety notice:

Components identified by Δ mark have special characteristics important for safety. When replacing any of these components use only manufacturer's specified parts.

* Bracketed indications in Ref. No. columns specify the area.

Parts without these indications can be used for all areas.

Numbering System of Resistor

Example

ERD	25	F	J	102
Type	Wattage	Shape	Tolerance	Value (10) $\times 10^2$ ohms

ERX	2	AN	J	471
Type	Wattage	Shape	Tolerance	Value (47) $\times 10^1$ ohms

Numbering System of Capacitor

Example

ECKD	1H	102	Z	F
Type	Voltage	Value (10 $\times 10^2$) $\times 10^{-6}$ microfarad	Tolerance	Peculiarity

ECEA	50	M	331
Type	Voltage	Peculiarity	Value (33) $\times 10^1$ microfarad

Resistor Type	Wattage	Tolerance
ERD : Carbon	10 : 1/8W	F : $\pm 1\%$
ERG : Metal Oxide	18 : 1/8W	G : $\pm 2\%$
ERX : Metal Film	S2 : 1/4W	J : $\pm 5\%$
ERQ : Fuse Type Metal	2F : 1/4W	K : $\pm 10\%$
ERD [] L : Carbon (chip)	50 : 1/2W	
ERO [] K : Metal Film (chip)	S1 : 1/2W	
ERC : Solid	12 : 1/2W	
	25 : 1/4W	
	1A : 1W	
	2A : 2W	

Capacitor Type	Voltage	Tolerance
ECE : Electrolytic	0J : 6.3V	C : $\pm 0.25\text{pF}$
ECCD : Ceramic	1A : 10V	D : $\pm 0.5\text{pF}$
ECKD : Ceramic	1C : 16V	G : $\pm 2\%$
ECQM : Polyester	1E : 25V	J : $\pm 5\%$
	1V : 35V	K : $\pm 10\%$
ECQP : Polypropylene	1H : 50V	M : $\pm 20\%$
	1J : 63V	Z : $\pm 80\%$
ECG : Ceramic	50 : 50V	P : $\pm 100\%$
ECEADDN : Non Polar Electrolytic	05 : 50V	
QCU [] : Ceramic (Chip Type)	2A : 100V	-0%
ECUX : Ceramic (Chip Type)	1 : 100V	
ECF : Semiconductor	2H : 500V	
	KC : 400V AC	
	KC : 125V AC (UL)	
EECW : Liquid electrolyte double layer capacitor		

Ref. No.	Part No.	Part Code	Ref. No.	Part No.	Part Code	Ref. No.	Part No.	Part Code
RESISTORS								
R317, R318	ERDS2T J223	001 152 2432 7	R503, R504	ERDS2T J472	001 152 2362 4			
R319	ERDS2T J393	001 152 2440 7	R505, R506	ERDS2T J473	001 152 2363 3			
R320, R321	ERDS2T J223	001 152 2432 7	R507, R508	ERDS1F J477	001 152 2631 2			
R322	ERDS2T J223	001 152 2432 7	R509, R510	ERDS2T J100	001 152 2420 1			
R323	ERDS2T J821	001 152 2454 1	R511	ERDS2T J154	001 152 2427 4			
R324	ERDS2T J151	001 152 2426 5	R512	ERD2FCG220	001 152 0190 4			
R325	ERDS2T J393	001 152 2440 7	(E, H, E, I)					
R109, R110	ERDS2T J680	001 152 2448 9	(E, H, E, I)	ERD25F J470	001 152 0309 7			
R111, R112	ERDS2T J184	001 152 2588 8	(E, H, E, I)					
R113, R114	ERDS2T J123	001 152 2424 7	(E, H, E, I)					
R115, R116	ERDS2T J563	001 152 2446 1	(E, H, E, I)					
R117, R118	ERDS2T J102	001 152 2346 4	(E, H, E, I)					
R119, R120 [EG]	ERDS2T J470		(E, H, E, I)					
R201, R202	ERDS2T J152	001 152 2350 8	(E, H, E, I)					
R203	ERDS2T J182	001 152 2352 6	(E, H, E, I)					
R204, R205	ERDS2T J562	001 152 2445 2	(E, H, E, I)					
R206	ERDS2T J562	001 152 2445 2	(E, H, E, I)					
R207, R208	ERDS2T J222	001 152 2353 5	(E, H, E, I)					
R209, R210	ERDS2T J222	001 152 2353 5	(E, H, E, I)					
R211, R212	ERDS2T J222	001 152 2353 5	(E, H, E, I)					
R213, R214	ERDS2T J222	001 152 2353 5	(E, H, E, I)					
R215, R216	ERDS2T J222	001 152 2353 5	(E, H, E, I)					
R217, R218	ERDS2T J222	001 152 2353 5	(E, H, E, I)					
R219, R220	ERDS2T J222	001 152 2353 5	(E, H, E, I)					
R221, R222	ERDS2T J222	001 152 2353 5	(E, H, E, I)					
R223, R224	ERDS2T J222	001 152 2353 5	(E, H, E, I)					
R301, R302	ERDS2T J223	001 152 2432 7	(E, H, E, I)					
R303, R304	ERDS2T J223	001 152 2432 7	(E, H, E, I)					
R305, R306	ERDS2T J223	001 152 2432 7	(E, H, E, I)					
R307, R308	ERDS2T J273	001 152 2436 3	(E, H, E, I)					
R309, R310	ERDS2T J103	001 152 2347 3	(E, H, E, I)					
R311, R312	ERDS2T J103	001 152 2347 3	(E, H, E, I)					
R313, R314	ERDS2T J273	001 152 2436 3	(E, H, E, I)					
R315, R316	ERDS2T J104	001 152 2348 2	(E, H, E, I)					
R317, R318	ERDS2T J223	001 152 2432 7	(E, H, E, I)					
R319	ERDS2T J393	001 152 2440 7	(E, H, E, I)					
R320, R321	ERDS2T J223	001 152 2432 7	(E, H, E, I)					
R322	ERDS2T J223	001 152 2432 7	(E, H, E, I)					
R323	ERDS2T J821	001 152 2454 1	(E, H, E, I)					
R324	ERDS2T J151	001 152 2426 5	(E, H, E, I)					
R325	ERDS2T J393	001 152 2440 7	(E, H, E, I)					
R401	ERDS2T J183	001 152 2429 2	(E, H, E, I)					
(E, H, E, I)			(E, H, E, I)					
R401	ERDS2T J562	001 152 2445 2	(E, H, E, I)					
R402	ERDS2T J183	001 152 2429 2	(E, H, E, I)					
(E, H, E, I)			(E, H, E, I)					
R402	ERDS2T J562	001 152 2445 2	(E, H, E, I)					
R403	ERDS2T J102	001 152 2346 4	(E, H, E, I)					
R403	ERDS2T J272	001 152 2354 4	(E, H, E, I)					
(E, H, E, I)			(E, H, E, I)					
R404	ERDS2T J102	001 152 2346 4	(E, H, E, I)					
R404	ERDS2T J272	001 152 2354 4	(E, H, E, I)					
(E, H, E, I)			(E, H, E, I)					
R405, R406	ERDS2T J473	001 152 2363 3	(E, H, E, I)					
R407, R408	ERDS2T J562	001 152 2445 2	(E, H, E, I)					
R409, R410	ERDS2T J224	001 152 2433 6	(E, H, E, I)					
R411, R412	ERDS2T J474	001 152 2443 4	(E, H, E, I)					
R413, R414	ERDS2T J223	001 152 2432 7	(E, H, E, I)					
R415, R416	ERDS2T J392	001 152 2439 0	(E, H, E, I)					
R417, R418	ERDS2T J182	001 152 2352 6	(E, H, E, I)					
R419, R420	ERDS2T J821	001 152 2454 1	(E, H, E, I)					
R421, R422	ERDS2T J563	001 152 2446 1	(E, H, E, I)					
R423, R424	ERDS2T J224	001 152 2433 6	(E, H, E, I)					
R425, R426	ERDS2T J392	001 152 2439 0	(E, H, E, I)					
R427, R428	ERDS2T J273	001 152 2357 1	(E, H, E, I)					
R429	ERDS2T J122	001 152 2423 8	(E, H, E, I)					
R430, R431	ERDS2T J562	001 152 2445 2	(E, H, E, I)					
R432	ERDS2T J562	001 152 2445 2	(E, H, E, I)					
R433, R434	ERDS2T J103	001 152 2347 3	(E, H, E, I)					
R435	ERDS2T J103	001 152 2347 3	(E, H, E, I)					
R436	ERDS2T J154	001 152 2427 4	(E, H, E, I)					
R437, R438	ERDS2T J392	001 152 2439 0	(E, H, E, I)					
R439, R440	ERDS2T J182	001 152 2352 6	(E, H, E, I)					
R445, R446	ERDS2T J224	001 152 2433 6	(E, H, E, I)					
R447, R501	ERDS2T J473	001 152 2363 3	(E, H, E, I)					
R502	ERDS2T J473	001 152 2363 3	(E, H, E, I)					

Ref. No.	Part No.	Part Code	Ref. No.	Part No.	Part Code	Ref. No.	Part No.	Part Code
R701 (EK)	ERD2FCG220	001 152 0190 4	C105, C106	ECKD1H102KB	001 103 1414 8	C425, C426	ECEA1HPS010	001 120 6063 4
R701 (EX, EH, E, I)	ERD25F J470	001 152 0309 7	C107, C108	ECEA1CPS220	001 120 6060 7	C427, C428	RCBS1H820KBY	001 103 5646 8
R702 (E, H, E, I)	ERD2FCG220	001 152 0190 4	C109, C110	ECFTD223KXL	001 108 0342 6	C429, C430	ECEA1HPS3R3	001 120 6064 3
R702 (E, H, E, I)	ERD25F J470	001 152 0309 7	C111, C112	ECFTD682KXL	001 108 0363 1	C431, C432	ECEA1CKS100	001 120 2600 7
R703 (E, H, E, I)	ERD2FCG220	001 152 0190 4	C113, C114	ECEA1HPS3R3	001 120 6064 3	C433, C434	ECKD1H103PF	001 103 1449 7
R703 (E, H, E, I)	ERD25F J100	001 152 0213 4	C115, C116	ECKD1H103PF	001 103 1449 7	C435	ECEA1CKS100	001 120 2600 7
R703 (E, H, E, I)	ERD25F J470	001 152 0309 7	C117, C118	ECEA1CKS100	001 120 2600 7	C436	ECEA1HK0R1	001 120 0340 6
R704, R705	ERDS2T J682	001 152 2365 1	C119 (EG)	RCBS1H180KBY		C437, C438	ECEA1HK010	001 120 0341 5
R706	ERDS2T J103	001 152 2347 3	C120 (EG)	RCBS1H180KBY		C439	ECKD1H103PF	001 103 1449 7
R707	ERDS2T J562	001 152 2445 2	C121 (EG)	RCBS1H151KBY		C501, C502	ECEA1HPS3R3	001 120 6064 3
R708	ERDS2T J472	001 152 2362 4	C122 (EG)	RCBS1H151KBY		C503, C504	ECCD1H121K	001 103 0390 3
R709	ERG1ANJ681	001 151 0086 8	C201, C202	ECKD1H103PF	001 103 1449 7	C505, C506	ECEA1CPS100	001 120 6036 7
(E, H, E, I)			C203, C204	RCBS1H101KBY	001 103 5569 4	C507, C508	ECCD1H150KC	001 103 0410 6
(E, H, E, I)			C205, C206	RCBS1H101KBY	001 103 5569 4	C509, C510	ECKD1H102KB	001 103 1414 8
(E, H, E, I)			C207, C208	RCBS1H101KBY	001 103 5569 4	C511, C512	ECFTD473KXL	001 108 0361 3
(E, H, E, I)			(E, H, E, I)			C514	ECFTD473KXL	001 108 0361 3
(E, H, E, I)			(E, H, E, I)			C515	ECEA1H100	001 120 0351 4
(E, H, E, I)			(E, H, E, I)			C516	ECEA0JK330	001 120 0141 1
(E, H, E, I)			(E, H, E, I)			C601	ECEA0JS102	001 120 0152 8
(E, H, E, I)			(E, H, E, I)			C602 Δ	ECKD1H223PF	001 103 1510 9
(E, H, E, I)			(E, H, E, I)			C603	ECEA0JKS470	001 120 2531 3
(E, H, E, I)			(E, H, E, I)			C604, C605	ECEA1VU330	001 120 3273 8
(E, H, E, I)			(E, H, E, I)			C606, C607	RCBS1H331KBY	001 103 5619 1

CIRCUIT BOARDS AND WIRING CONNECTION DIAGRAM

A
B
C
D
E
F

PHONO TUNER VD / AUX VCR / TAPE 2

REMOTE CONTROL

CONTROL SURROUND SPEAKERS MAIN SPEAKERS

(REC OUT) (PLAYBACK)

(TAPE 1) (TUNER)

(TURNTABLE) (CD)

(8 ~ 16 Ω)

(8 ~ 16 Ω)

C MAIN P.C.B.

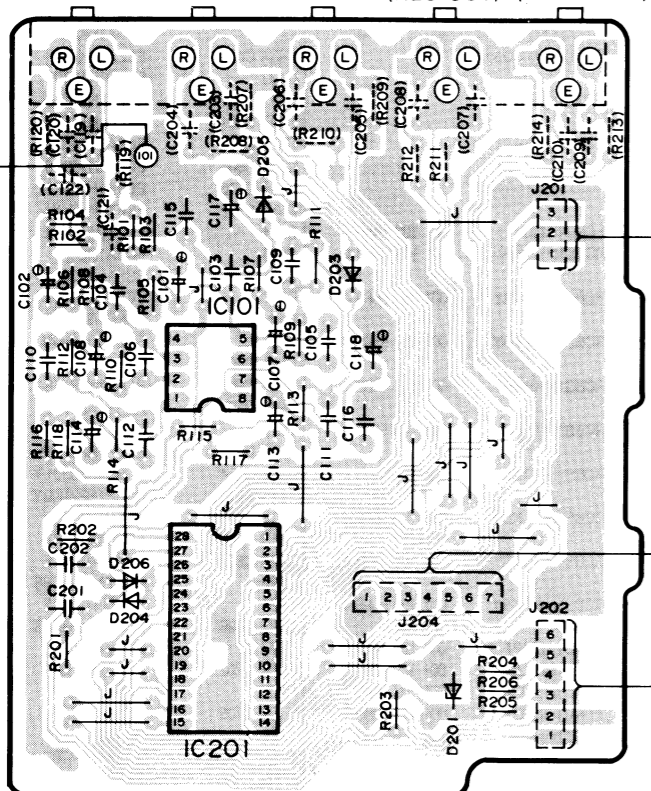

A ELECTRIC SELECTOR/
IN/OUTPUT TERMINAL (1) P.C.B.

CD EXT OUT EXT IN TAPE 1

(REC OUT) (PLAYBACK)

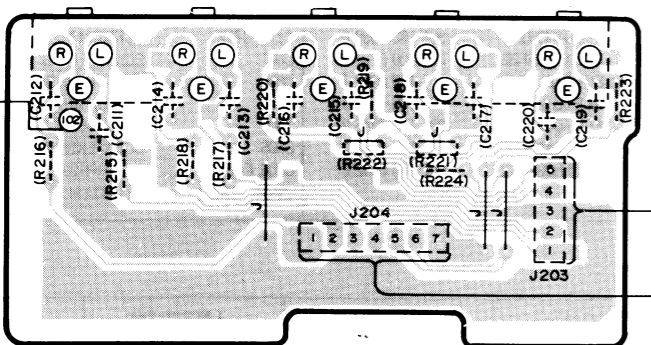

B IN/OUTPUT TERMINAL (2) P.C.B.

E VOLUME P.C.B.

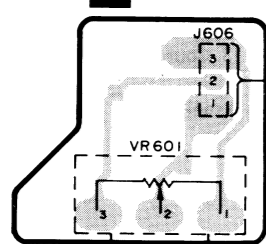

VOLUME

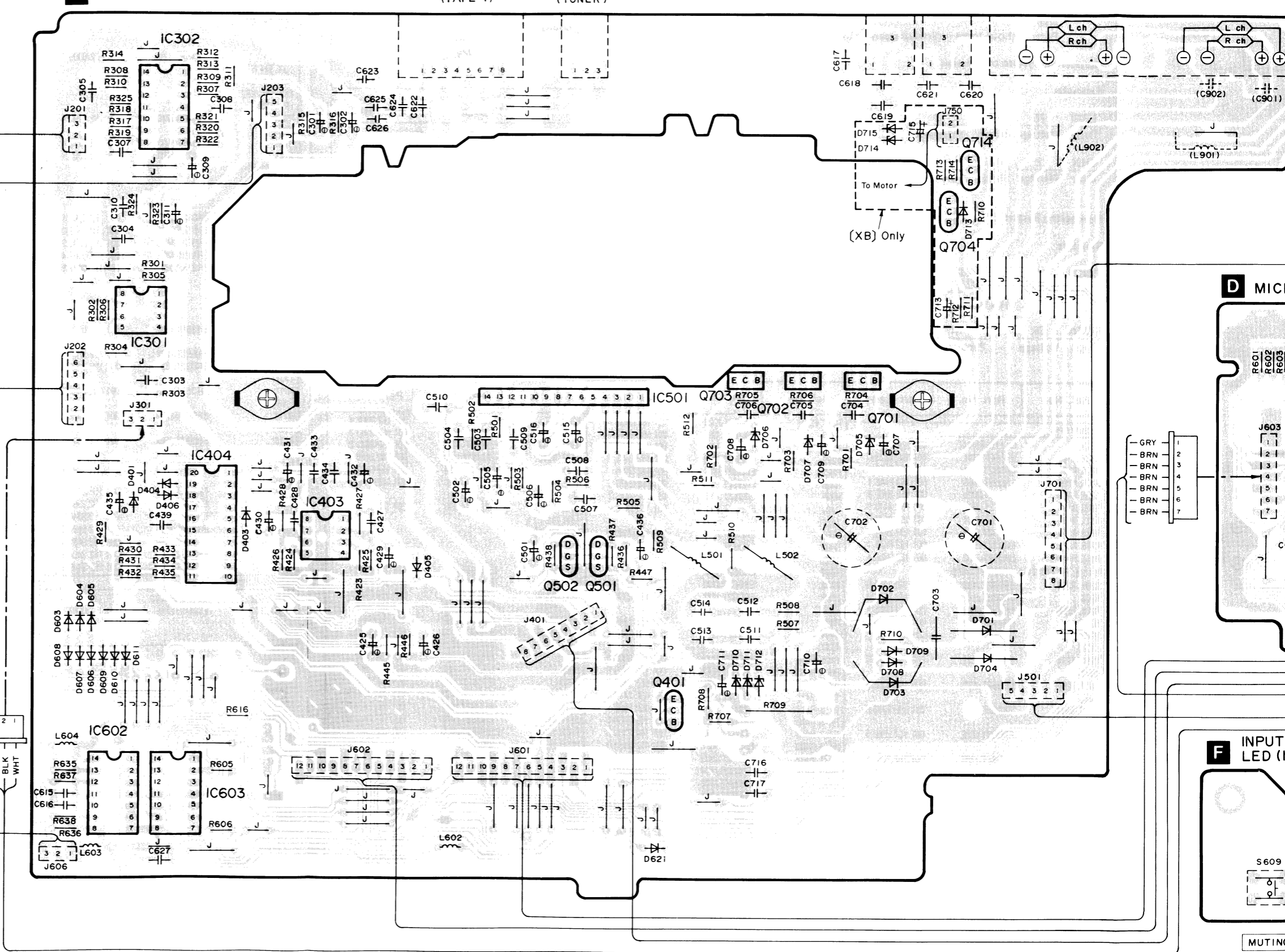

D MICP

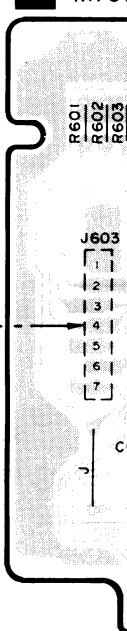

F INPUT LED (I)



MUTING

SURROUND SPEAKERS
(8 ~ 16 Ω)

MAIN SPEAKERS
(8 ~ 16 Ω)

POWER SUPPLY CONNECTOR
(TAPE I)

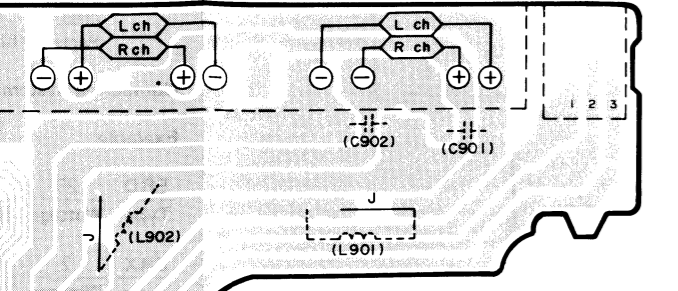

AC OUTLET

AC INLET
AC 220V (50/60Hz)

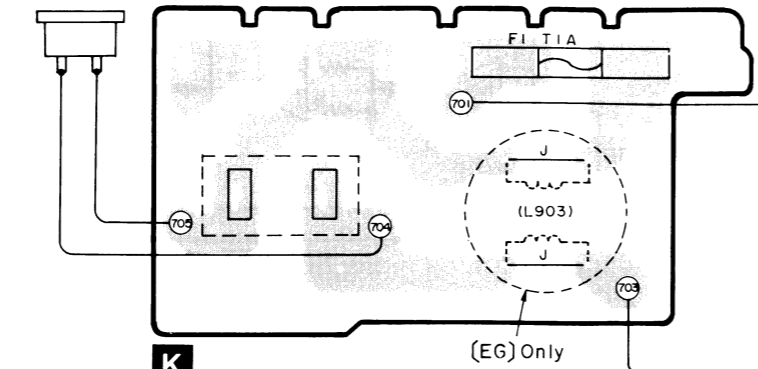

K POWER SUPPLY P.C.B.

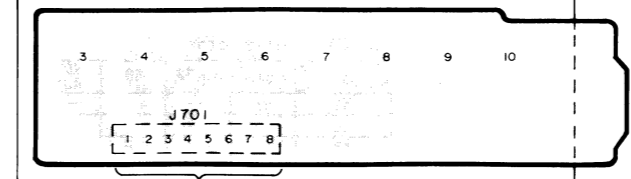

T I
Power transformer

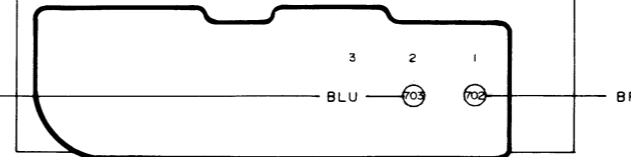

H TONE CONTROL P.C.B.

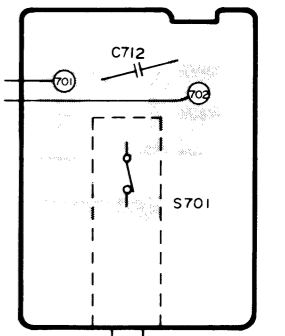

POWER

J HEADPHONES P.C.B.

D MICROCOMPUTER/FL P.C.B.

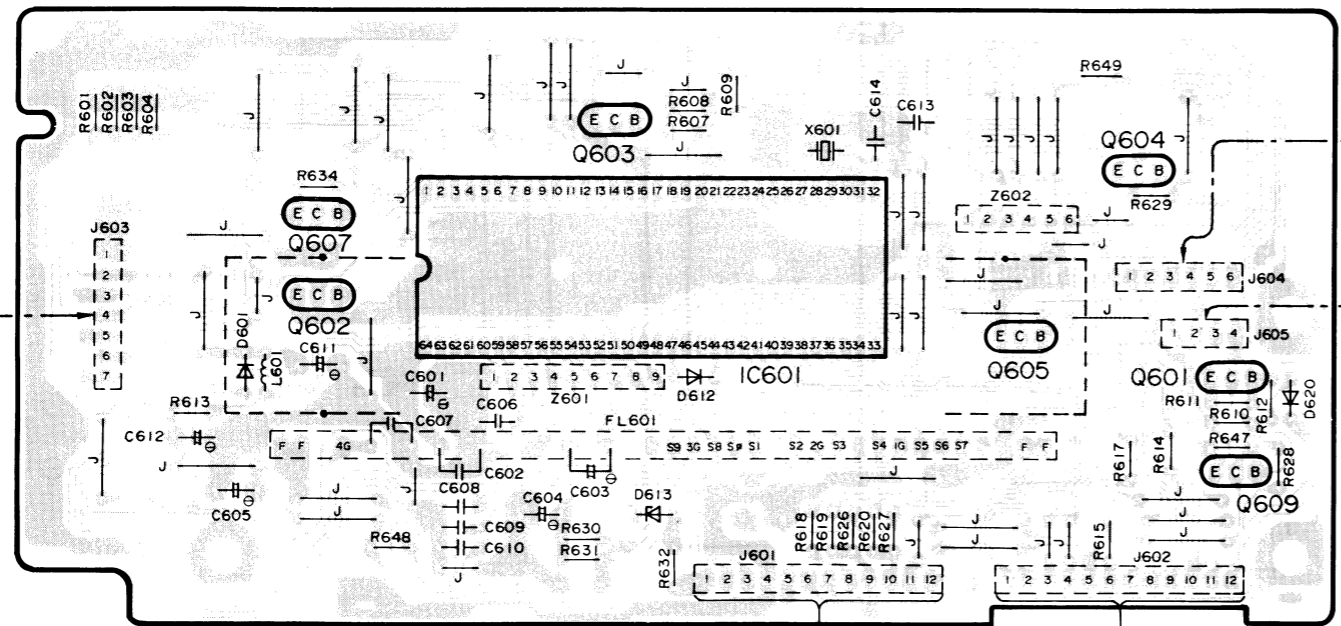

SURROUND

SUPER BASS

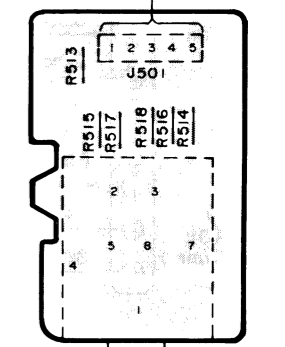
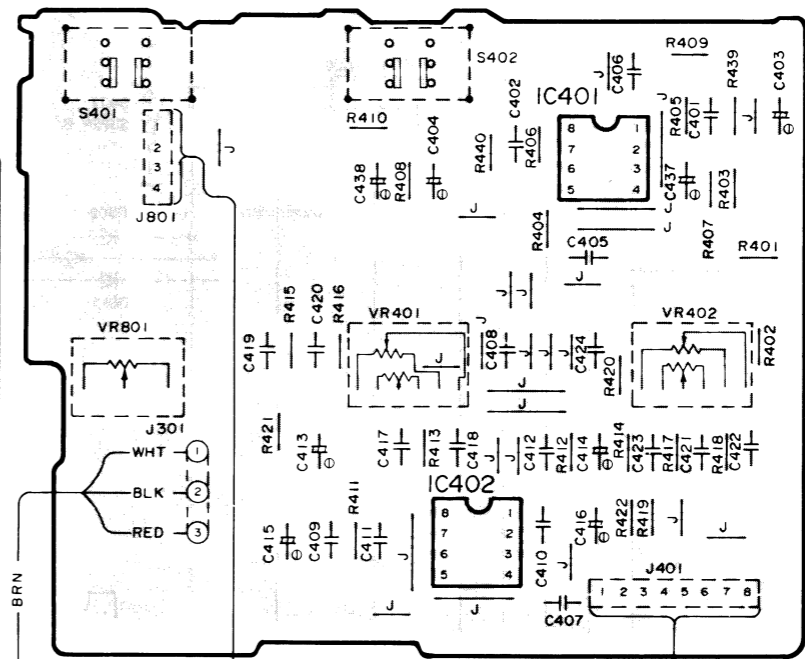

PHONES

L MIC AMP P.C.B.

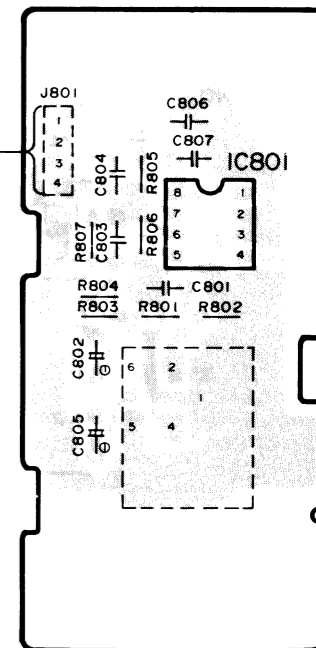

MIC

F INPUT SELECTOR SWITCH/LED (1) P.C.B.

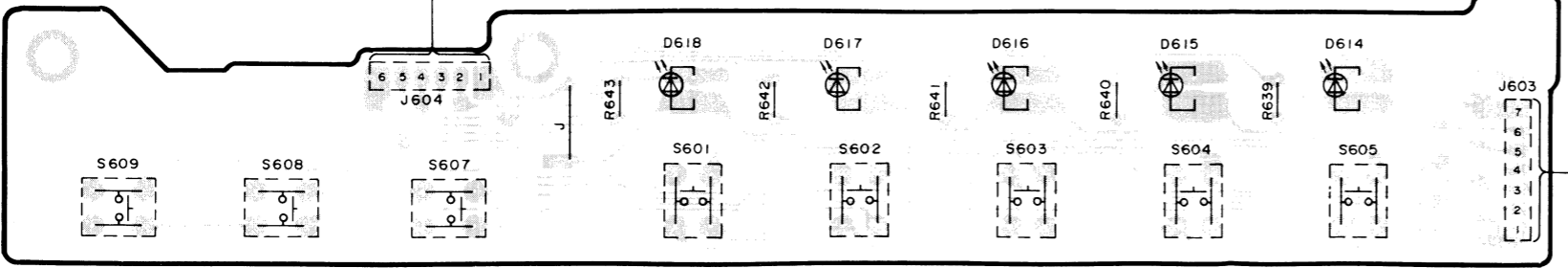

MUTING (R ch) **BALANCE** (L ch) **PHONO** **TUNER** **VIDEO DISC / AUX** **TAPE I** **VTR / TAPE 2**

G INPUT SELECTOR SWITCH/LED (2) P.C.B.

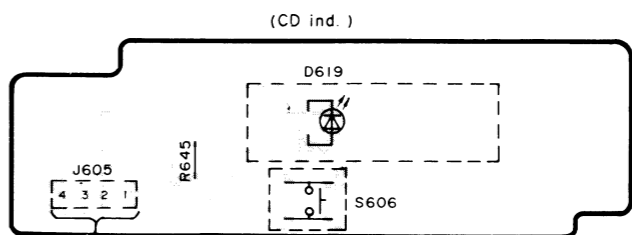

CD

(EK) ONLY

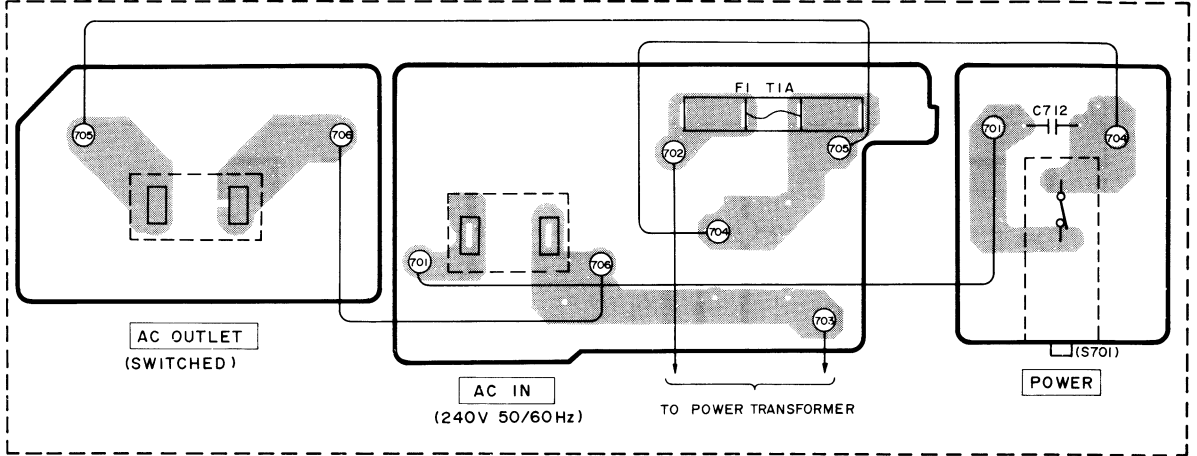

(EW) ONLY

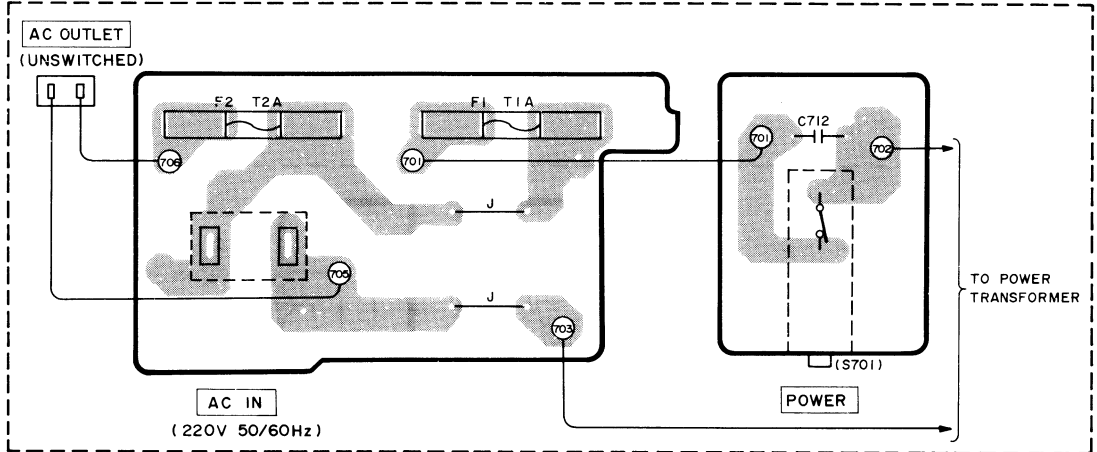

(XA, XB) ONLY

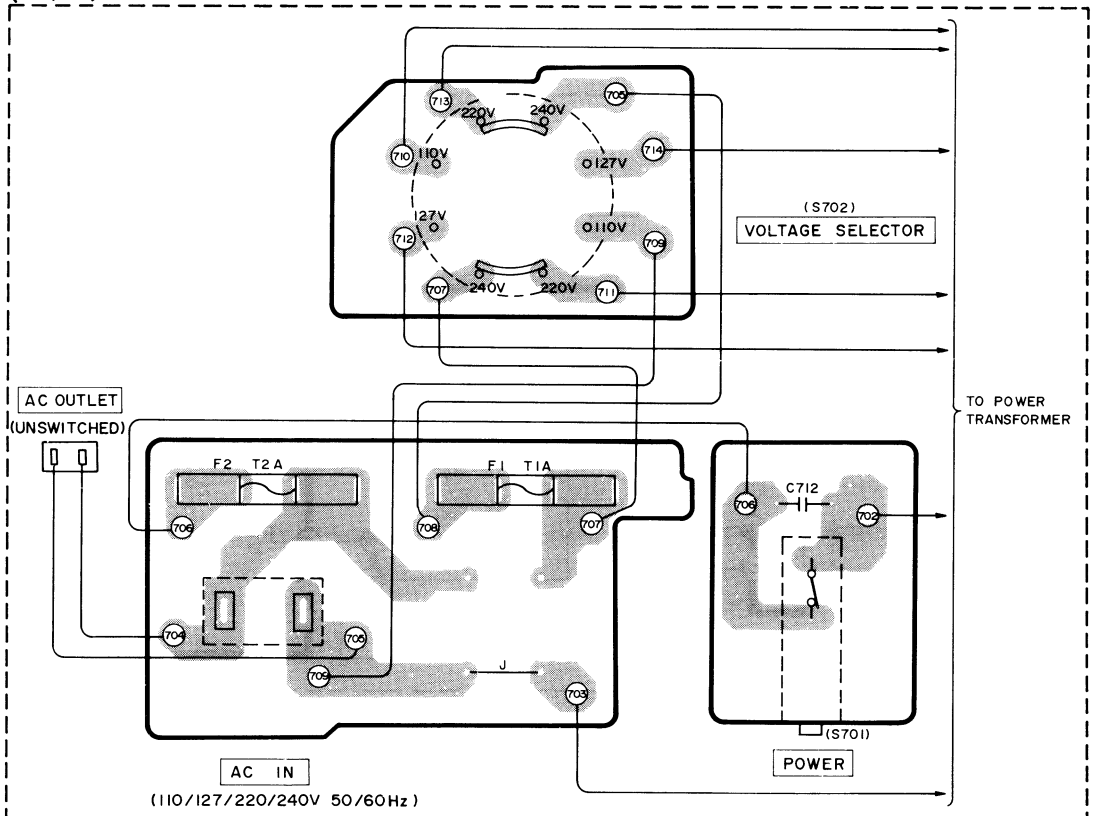

(EK) ONLY

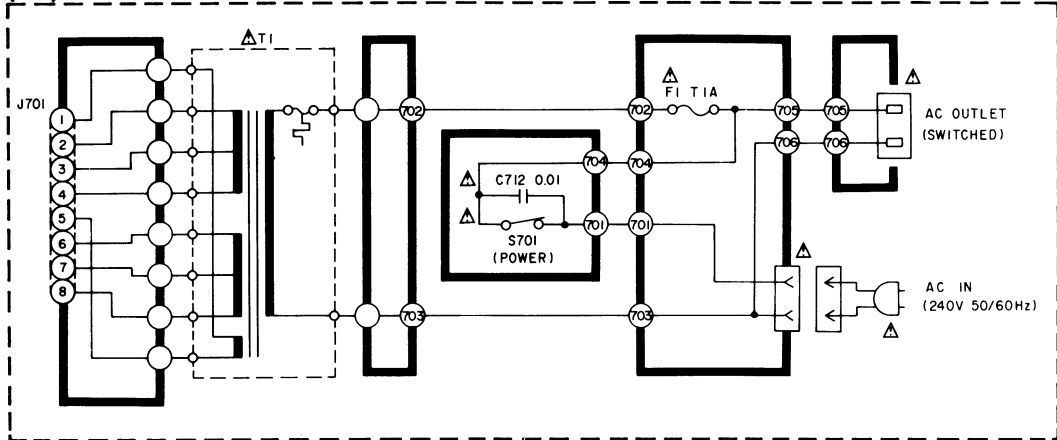

(EW) ONLY

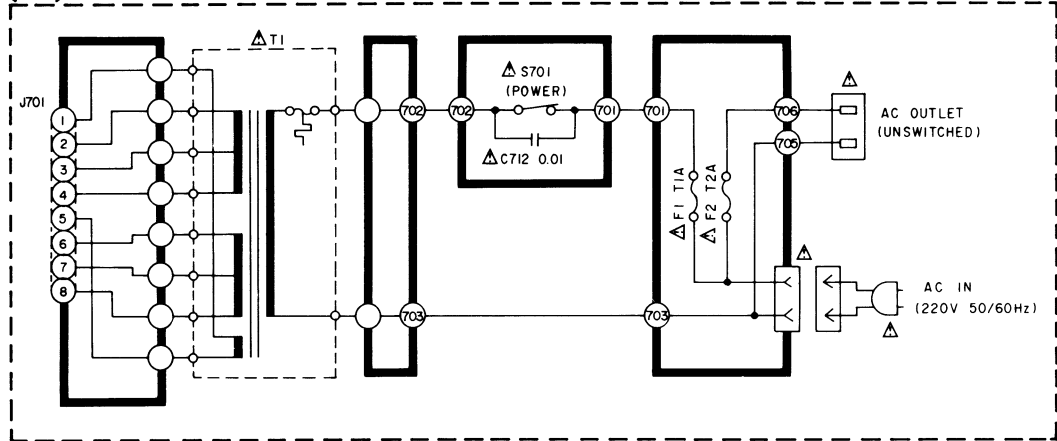

(XA, XB) ONLY

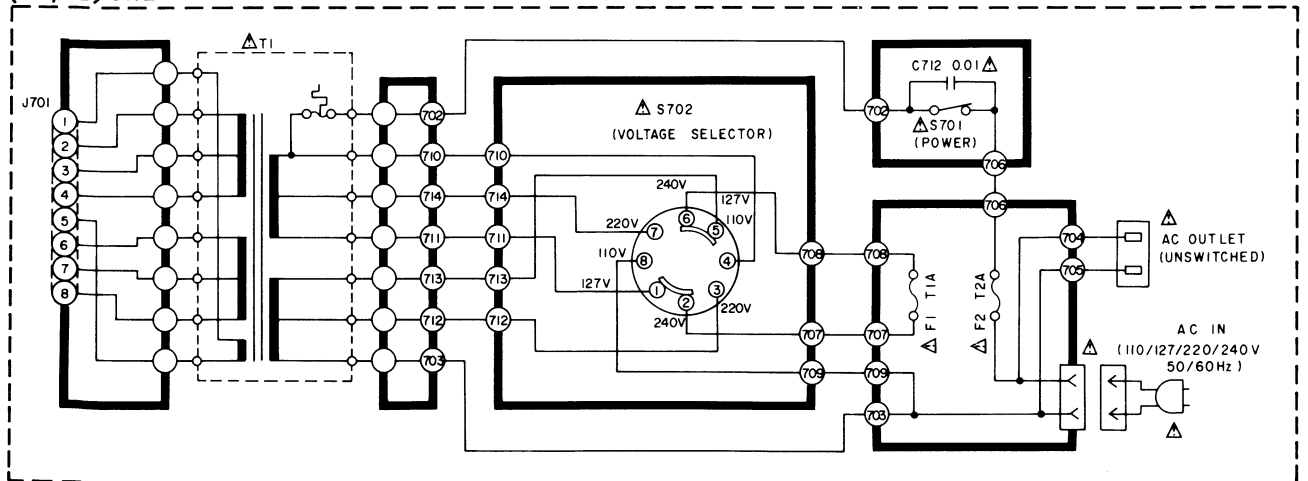

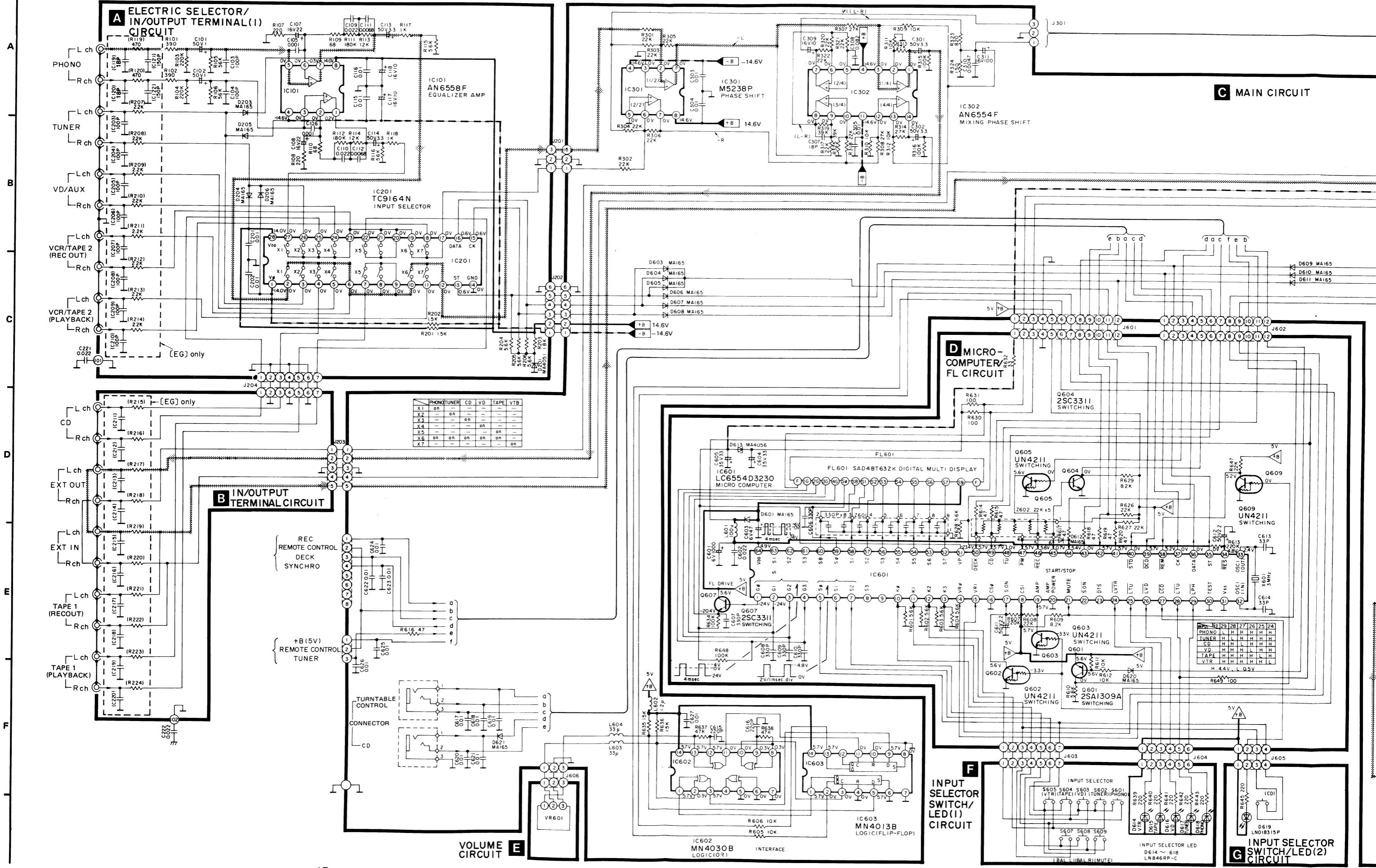

	PHONO	TUNER	CD	VD	TAPE	VTR
X1	on	---	---	---	---	---
X2	---	on	---	---	---	---
X3	---	---	on	---	---	---
X4	---	---	---	on	---	---
X5	---	---	---	---	on	---
X6	on	on	on	on	on	---
X7	---	---	---	---	---	on

PHONO	TUNER	CD	VD	TAPE	VTR
H	H	H	H	H	H
H	H	H	H	H	H
H	H	H	H	H	H
H	H	H	H	H	H
H	H	H	H	H	H
H	H	H	H	H	H
H	H	H	H	H	H
H	H	H	H	H	H
H	H	H	H	H	H

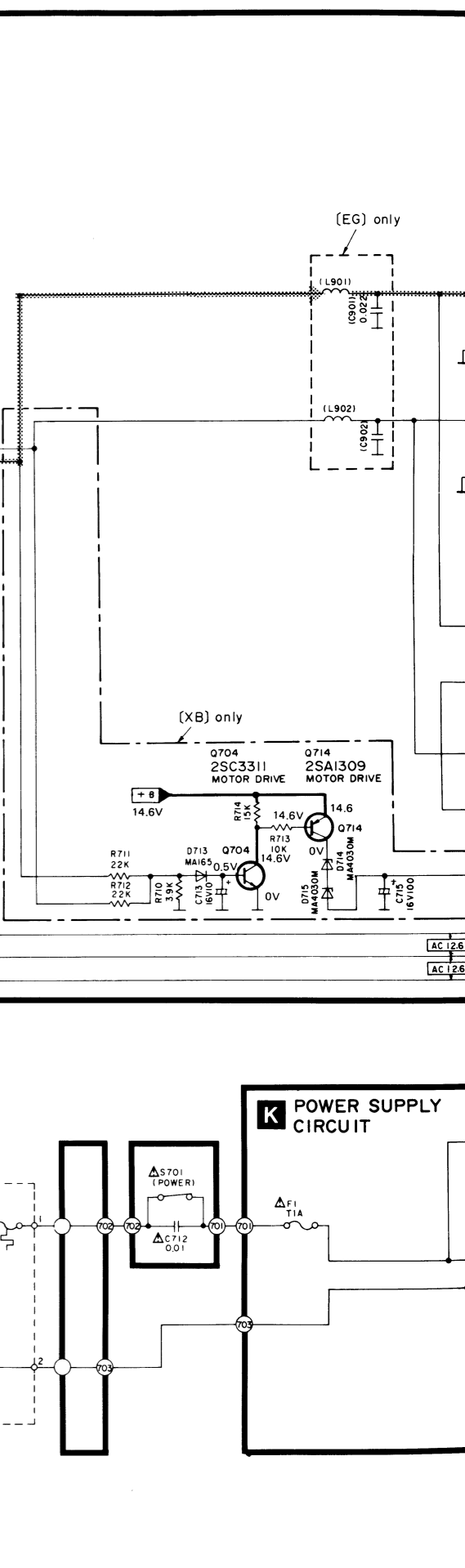
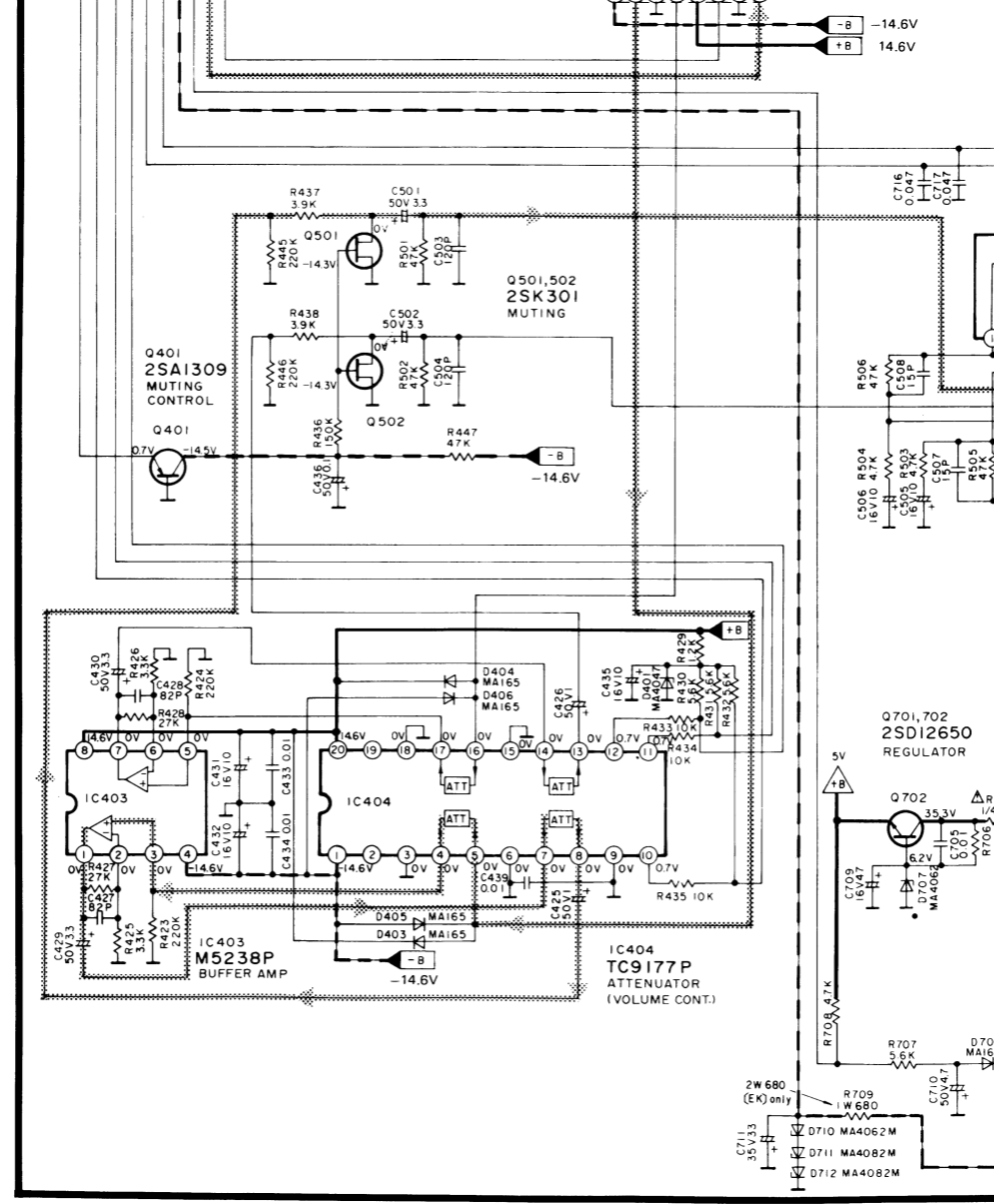
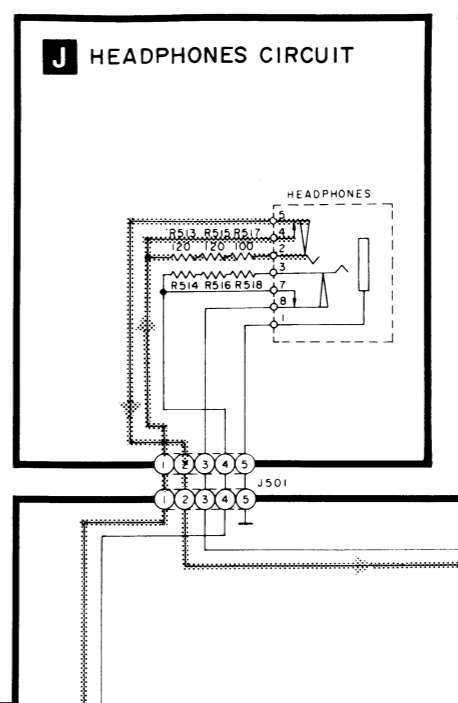
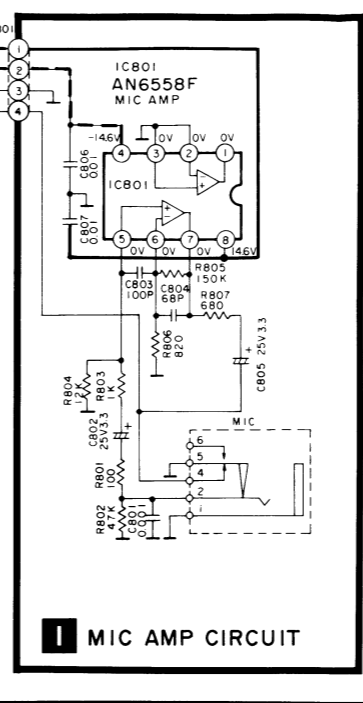
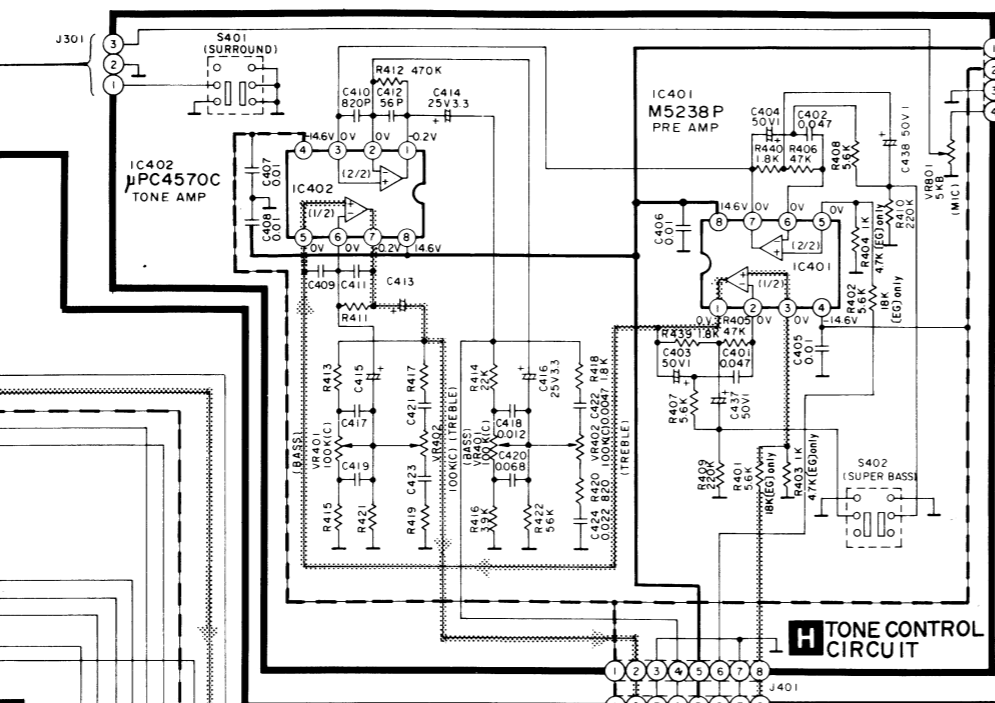
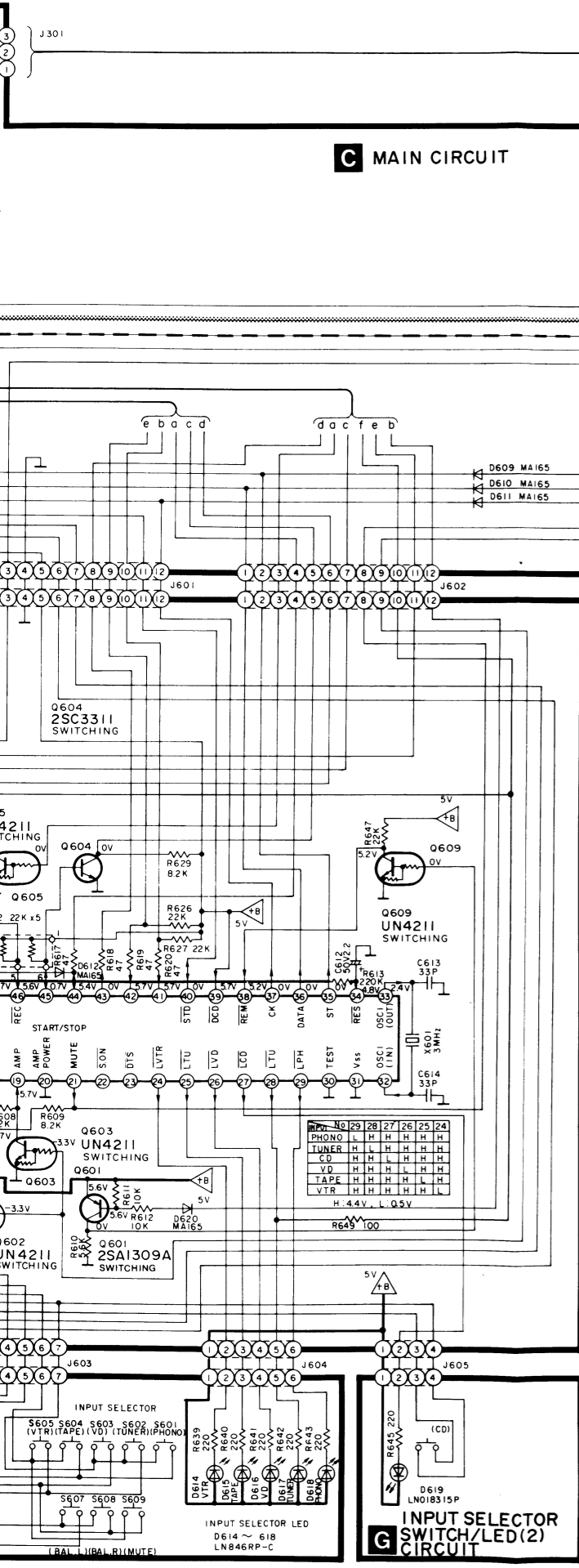

SCHEMATIC DIAGRAM

(This schematic diagram may be modified at any time with the development of new technology.)

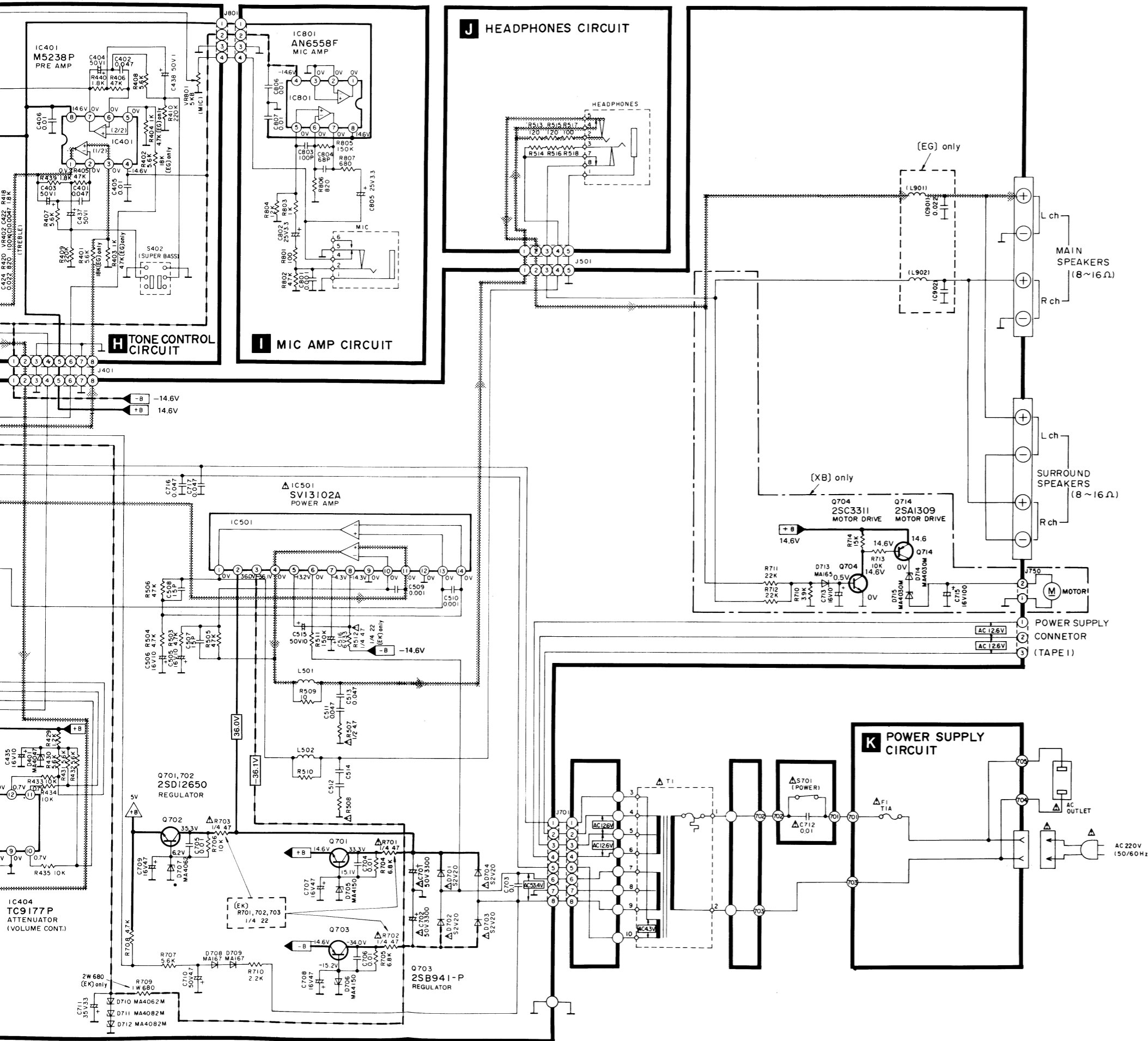

Notes:

1. S401 : AV surround on/off switch in "off" position.
2. S402 : Super-bass switch in "off" position.
3. S601~S606 : Input selector switches in "off" position.
S601: phono, S602: tuner,
S603: Video disc/aux, S604: tape 1,
S605: VTR/tape 2, S606: CD
4. S607, S608 : Balance switches.
S607: left, S608: right
5. S609 : Muting switch.
6. S701 : Power switch.
(■ off, ▲ on)
7. Indicated voltage values are the standard values for the unit measured by the DC electronic circuit tester (high-impedance) with the chassis taken as standard. Therefore, there may exist some errors in the voltage values, depending on the internal impedance of the DC circuit tester.
8. Left-channel phono signal route.
 Microphone signal.
 Phase difference signal.
 ⊕ B voltage line ⊖ B voltage line.
9. Important safety notice:
Components identified by ▲ mark have special characteristics important for safety. When replacing any of these components, use only manufacturer's specified parts.

* Caution!

- IC and LSI are sensitive to static electricity. Secondary trouble can be prevented by taking care during repair.
- * Cover the parts boxes made of plastics with aluminum foil.
- * Ground the soldering iron.
- * Put a conductive mat on the work table.
- * Do not touch the legs of IC or LSI with the fingers directly.

● Fluorescent display tube (FL)

* Grid connections

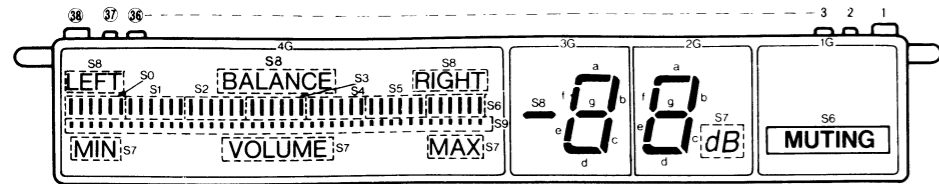

Pin No.	38	37	36	35	34	33	32	31	30	29	28	27	26	25	24	23	22	21	20
Name of Terminal	F 2	F 2	N P	4 G	N P	N P	N P	N P	N P	N P	4 G	N P	N P	N P	N P	N P	N P	4 G	
Pin No.	19	18	17	16	15	14	13	12	11	10	9	8	7	6	5	4	3	2	1
Name of Terminal	S 9	3 G	S 8	S 0	S 1	3 G	S 2	S 3	2 G	S 4	S 5	S 6	S 7	1 G	N P	F 1	F 1		

* Anode connections

	4G	3G	2G	1G
S0		a	a	—
S1		b	b	—
S2		c	c	—
S3		d	d	—
S4		e	e	—
S5		f	f	—
S6		g	g	MUTING
S7	MIN VOLUME MAX	—	dB	—
S8	LEFT BALANCE RIGHT	—	—	—
S9	 (x7)	—	—	—

■ REPLACEMENT PARTS LIST

- Notes: 1. Part numbers are indicated on most mechanical parts. Please use this part number for parts order.
 2. Important safety notice: Components identified by Δ mark have special characteristics important for safety. When replacing any of these components, use only manufacturer's specified parts.
 3. Bracketed indications in Ref. No. columns specify the area. Parts without these indications can be used for all areas.
 4. The parenthesized numbers in the column of description stand for the quantity per set.

Ref. No.	Part No.	Part Code	Description	Ref. No.	Part No.	Part Code	Description
INTEGRATED CIRCUITS				T1 (XA, XB,) (PA, PE)			
IC101	AN6558F	001 060 4009 1	I.C., EQUALIZER	SLT5M506 001 202 9022 8 POWER TRANSFORMER			
IC201	TC9164N	001 061 0204 1	I.C., INPUT SELECTOR	COMPONENT COMBINATIONS			
IC301	M5238P	001 060 8887 7	I.C., SHIFT	Z601	EXFP8331MW	001 230 1628 6	C-R COMBINATION
IC302	AN6554F	001 060 2392 1	I.C., MIXING	Z602	EXBP85223JR	001 230 2835 7	COMPONENT COMBINATION
IC401	M5238P	001 060 8887 7	I.C., PRE AMP	OSCILLATORS			
IC402	SV1UPC4570C	001 060 8992 7	I.C., TONE AMP	X601	SVFCSA300MG	001 241 1296 5	CERAMIC FILTER
IC403	M5238P	001 060 8887 7	I.C., AMP	DISPLAYS			
IC404	TC9177P	001 061 0839 2	I.C., VOLUME CONTROL	FL601	SAD4BT63ZK	001 001 0508 4	DISPLAY
IC501	SV13102A	001 061 4832 3	INTEGRATED CIRCUIT	FUSES			
IC601	LC6554D-3230	001 061 4016 7	I.C., MICRO COMPUTER	F1	XBA2C10TB0	002 380 1351 1	CURRENT FUSE, T1A250V
IC602	MN4030B	001 060 6553 4	I.C., LOGIC	(EK)	XBA2C10NS5	002 380 0404 9	FUSE, T1A250V
IC603	MN4013B	001 060 3656 0	I.C., LOGIC	(EX, EH, E1) (EF, EB, EW) (XL, XA, XB) (PA, PE, EG)	XBAS2A2001	002 380 0410 1	FUSE, T2A250V
IC801	AN6558F	001 060 4009 1	I.C., MIC AMP	SWITCHES			
TRANSISTORS				S401, S402	SSH1198	003 435 5171 7	SW
Q401	2SA1309A-R	001 030 6079 7	TRANSISTOR	S601, S602	EVQQA05G	003 439 2072 1	SW
Q501, Q502	2SK301	001 030 2428 2	TRANSISTOR	S603, S604	EVQQA05G	003 439 2072 1	SW
Q601	2SA1309A-R	001 030 6079 7	TRANSISTOR	S605, S606	EVQQA05G	003 439 2072 1	SW
Q602, Q603	UN4211	001 030 4033 9	TRANSISTOR	S607, S608	EVQQA05G	003 439 2072 1	SW
Q604	2SC3311A-Q	001 030 5279 5	TRANSISTOR	S609	EVQQA05G	003 439 2072 1	SW
Q605	UN4211	001 030 4033 9	TRANSISTOR	S701 Δ	ESB8249V	003 435 5877 0	POWER SW
Q606	2SC3311A-Q	001 030 5279 5	TRANSISTOR	S702	ESE37263	003 430 2327 2	SW
Q607	UN4211	001 030 4033 9	TRANSISTOR	(XA, XB) (PA, PE)			
Q608	2SD1265-0	001 030 2632 6	TRANSISTOR	CABINET AND CHASSIS			
Q703	2SB941-P	001 030 2636 4	TRANSISTOR	1	SGYUX840-KN	016 840 7548 4	FRONT PANEL (K)
Q704	2SC3311A-Q	001 030 5279 5	TRANSISTOR	1-1	SGU538A	016 842 1597 9	GLASS PLATE
(XB)				2	SGX9028A	016 846 3749 3	ORNAMENT
(XB)				3	SDU323A	016 842 1538 8	FILTER
DIODES				4	SGL238-1	016 846 3751 9	ORNAMENT
D201	MA4051-M	001 032 4947 6	DIODE	5	SGL242	016 846 3750 0	ORNAMENT
D203, D204	MA165	001 032 0494 0	DIODE	6	SBC666-1	016 702 6076 0	BUTTON
D205, D206	MA165	001 032 0494 0	DIODE	7	SBC928	016 702 6969 2	KNOB
D401	MA4047M	001 032 6186 5	DIODE	8	SBN1221	016 700 1974 5	KNOB
D403, D404	MA165	001 032 0494 0	DIODE	9	SBN1224	016 700 1972 7	KNOB
D405, D406	MA165	001 032 0494 0	DIODE	10	SBC925B	016 702 7115 6	BUTTON
D601, D603	MA165	001 032 0494 0	DIODE	11	SBC926	016 702 6963 8	KNOB
D604, D605	MA165	001 032 0494 0	DIODE	12	SBC927A	016 702 6956 7	KNOB
D606, D607	MA165	001 032 0494 0	DIODE	13	SKC2050K961	016 800 3040 7	CABINET ASS'Y
D608, D609	MA165	001 032 0494 0	DIODE	(EX, EH, E1) (EF, EB, EW) (EK, XL, XA) (PA, PE, EG)			
D610, D611	MA165	001 032 0494 0	DIODE	13	SKC2050K962	016 800 3126 2	CABINET BODY
D612	MA165	001 032 0494 0	DIODE	14	SJJ130-3	003 400 7580 9	JACK
D613	MA4056-M	001 032 7209 1	DIODE	15	SJJ63D	003 400 6041 5	JACK
D614, D615	LN846RP-C	001 032 8341 4	LED, INPUT	16	SJJ63E	003 400 4329 0	JACK, HEADPHONE
D616, D617	LN846RP-C	001 032 8341 4	LED, INPUT	17	SUS832	016 726 0938 1	SPRING
D618	LN846RP-C	001 032 8341 4	LED, INPUT	18	SHE185	016 918 0330 9	SPACER
D619	LN018315P	001 032 9292 2	LED, CD INPUT	19	SMC1261	016 601 0617 9	SHIELD COVER
D620, D621	MA165	001 032 0494 0	DIODE	20	SMC1262	016 601 0616 0	SHIELD COVER
D701, D702 Δ	SVDS2V20	001 032 1343 0	RECTIFIER	21	SMC6379	016 601 0538 7	SHIELD COVER
D703, D704 Δ	SVDS2V20	001 032 1343 0	RECTIFIER	22	SMC1263	016 601 0615 1	SHIELD COVER
D705, D706	MA4150M	001 032 4961 8	DIODE	23	SUN3033	016 650 5282 7	BRACKET
D707	MA4062-M	001 032 7211 7	DIODE	24	SUN3040	016 650 5281 8	BRACKET
D708, D709	MA167	001 032 4142 5	DIODE	25	SKU11650-1	016 802 2190 8	BOTTOM BOARD
D710	MA4062-M	001 032 7211 7	DIODE	26	SKL307	016 828 0325 7	FOOT
D711, D712	MA4082M	001 032 4955 6	DIODE	27	SGP7031-1A	016 840 7706 8	REAR PANEL
D714, D715	MA4030M	001 032 5807 3	DIODE	(EK)	SGP7031-2A	016 840 7841 2	REAR PANEL
(XB)				(XA)	SGP7031-3A	016 840 7842 1	REAR PANEL
VARIABLE RESISTORS				(XL)	SGP7031-4A	016 840 7843 0	REAR PANEL
VR401, VR402	EWC2XAF20C15	001 174 8804 3	VARIABLE RESISTOR	(XB)			
VR601	EVQWX2F2040B	001 174 8803 4	VR	PACKINGS			
VR801	EVH0XAF20B53	001 174 8846 3	V.R.	P1	SPP740	016 978 0437 3	PROTECTION COVER
COILS AND TRANSFORMERS				P2	SPG5933	016 971 5033 4	CARTON BOX
L501, L502	SLQY07G-40	001 211 2149 9	CHOKE COIL	(EX, EH, E1) (EB, EW, EK) (XL, XA, XB) (PA, PB, EG)			
L601	ELEXT101KA	001 211 3878 9	COIL	P2	SPG5934	016 971 5072 7	CARTON BOX
L602	ELEXT120KA	001 211 3879 8	COIL	(EF)			
L603, L604	ELEXT330KA	001 211 3880 5	COIL	P3	SPS4914-1	016 977 3328 0	PAD
L901, L902	SLQY07G-40	001 211 2149 9	CHOKE COIL	P4	SPS4915-2		PAD
(EG)				P5	SPS4999	016 977 3344 0	PAD
L903 Δ	SLQZ650MH49	001 210 7126 1	COIL	ACCESSORIES			
(EG)				A1 Δ	SFDAC05E03	003 490 4809 5	POWER CORD
(EX, EH, E1) (EF, EB, EW) (EG)	SLT5M504	001 202 9072 6	POWER TRANSFORMER	A1 Δ	SJA168-1	003 490 4122 9	POWER CORD
(EG)				(XA, PE)	SJA173	003 490 4161 2	POWER CORD
T1	SLT5M505	001 202 9022 6	POWER TRANSFORMER	(XL)			
(EK, XL)							

Ref. No.	Part No.	Part Code	Description
27	SGP7031-5A	016 840 7845 8	REAR PANEL
(PA, PE)			
27	SGP7031A	016 840 7758 6	REAR PANEL
(EX, EH, E1) (EF, EB)			
27	SGP7031B	016 840 7846 7	REAR PANEL
(EG)			
27	SGP7031C	016 840 7847 6	REAR PANEL
(EW)			
28	SJF3062-2NK	003 410 8074 2	TERMINAL PLATE
29	SJF4818-1	003 410 7347 0	TERMINAL BOARD
30	SJS306	003 403 4936 8	CONNECTOR
31	SJS804	003 403 4910 8	CONNECTOR
32	SJS9231A	003 410 5984 5	SOCKET COVER
(EX, EH, E1) (EF, EB, EW) (EK, XA, XB) (PA, PE, EG)			
32 Δ	SJS9234A	003 400 5921 6	AC INLET COVER
(XL)			
33 Δ	SJS9332B	003 403 7377 5	CONNECTOR
(EK)			
34	SHR301	016 645 0044 0	CLAMPER
(EX, EH, E1) (EF, EB, EW) (EG)			
35	SJS5425	003 400 5926 1	SOCKET(4P)
35	SJS5629	003 400 5917 2	CONNECTOR
35	SJS5633	003 400 5929 8	CONNECTOR
35	SJS5715	003 400 6034 4	SOCKET(7P)
35	SJS5717	003 400 6573 2	SOCKET
36	SJT783	003 410 6001 7	CONTACT
37	SNE2053	005 500 0720 0	SCREW
38	SNE2118	005 500 5011 2	SCREW
39	SNE2123	005 500 4920 8	SCREW
40	SNE2129-1	005 500 7938 6	SCREW
41	SNE4021	005 507 0372 5	NUT
42	XTB3+8FFZ	005 501 1590 3	SCREW
43	XTB3+8JFZ1	005 501 2523 0	SCREW
(EX, EH, E1) (EF, EB, EW) (EK, XL, XA) (PA, PE, EG)			
44	XTB3+8G	005 501 2607 7	SCREW
45	XTW3+15T	005 501 1353 4	SCREW
46	XTWS3+8T	005 501 3311 6	SCREW
47	XTB3+8FFR	005 501 3569 2	SCREW
48	XTB3+8JFZ	005 501 0138 3	SCREW
49	SJT30840LX-V	003 410 5998 9	LUG TERMINAL
49	SJT31243-V	003 410 7349 8	CONNECTOR
50	SJT30645JQ	003 410 8079 7	TERMINAL PLATE
51	SJS50678JQ	003 403 7155 7	CONNECTOR
52	SJT30345JQ	003 410 8077 9	TERMINAL PLATE

Ref. No.	Part No.	Part Code	Description
PACKINGS			
P1	SPP740	016 978 0437 3	PROTECTION COVER
P2	SPG5933	016 971 5033 4	CARTON BOX
(EX, EH, E1) (EB, EW, EK) (XL, XA, XB) (PA, PB, EG)			
P2	SPG5934	016 971 5072 7	CARTON BOX
(EF)			
P3	SPS4914-1	016 977 3328 0	PAD
P4	SPS4915-2		PAD
P5	SPS4999	016 977 3344 0	PAD
ACCESSORIES			
A1 Δ	SFDAC05E03	003 490 4809 5	POWER CORD
(EX, EH, E1) (EF, EB, EW) (EG)			
A1 Δ	SJA168-1	003 490 4122 9	POWER CORD
(XA)			
(PA, PE)			
A1 Δ	SJA173	003 490 4161 2	POWER CORD
(XL)			

Ref. No.	Part No.	Part Code	Description	Ref. No.	Part No.	Part Code	Description
27	SGP7031-5A	016 840 7845 8	REAR PANEL	53	SJS50378JQ	003 403 7153 9	CONNECTOR
[PA, PE]				54	SJT3213	003 410 6011 5	CONNECTOR
27	SGP7031A	016 840 7758 6	REAR PANEL	[XB]			
(EX, EH, E1)				54	SJT3319	003 403 3892 7	CONNECTOR
(EF, EB)				54	SJT3415	003 403 3909 5	POST(4P)
27	SGP7031B	016 840 7846 7	REAR PANEL	54	SJT3611	003 410 6000 8	CONNECTOR
[EG]				54	SJT3709	003 403 4232 3	CONNECTOR
27	SGP7031C	016 840 7847 6	REAR PANEL	55	SJS9231-1B	003 400 7442 8	SOCKET
[EW]				[EX, EH, E1]			
28	SJF3062-2NK	003 410 8074 2	TERMINAL PLATE	[EB, EF, EW]			
29	SJF4818-1	003 410 7347 0	TERMINAL BOARD	[EK, XA, XB]			
30	SJS306	003 403 4936 8	CONNECTOR	[PA, PE, EG]			
31	SJS804	003 403 4910 8	CONNECTOR	55	SJS9234B	003 400 5922 5	AC INLET
32	SJS9231A	003 410 5984 5	SOCKET COVER	[XL]			
[EX, EH, E1]				56	SJS9225	003 400 3946 5	AC OUTLET
[EF, EB, EW]				[EX, EH, E1]			
[EK, XA, XB]				[EF, EB, EW]			
[PA, PE, EG]				[XA, EG]			
32	SJS9234A	003 400 5921 6	AC INLET COVER	[PA, PE]			
[XL]				56	SJS9332A	003 403 7376 6	CONNECTOR
33	SJS9332B	003 403 7377 5	CONNECTOR	[EK]			
[EK]				57	SJT30545JQ	003 410 8078 8	CONNECTOR
34	SHR301	016 645 0044 0	CLAMPER	58	SJS50578JQ	003 403 7154 8	CONNECTOR
[EX, EH, E1]				59	SJS5431	003 400 5927 0	SOCKET
[EF, EB, EW]				60	SJS5331	003 400 5924 3	CONNECTOR
[EG]				60	SJT388	003 410 6092 8	LUG TERMINAL
35	SJS5425	003 400 5926 1	SOCKET(4P)	[EX, EH, E1]			
35	SJS5629	003 400 5917 2	CONNECTOR	[EB, EF, EW]			
35	SJS5633	003 400 5929 8	CONNECTOR	[XA, XB]			
35	SJS5715	003 400 6034 4	SOCKET(7P)	[PA, PE]			
35	SJS5717	003 400 6573 2	SOCKET	61	SJT785	003 410 6015 1	CONTACT
36	SJT783	003 410 6001 7	CONTACT	62	SJPS205-2Y	003 492 6791 0	SHORTING PIN
37	SNE2053	005 500 0720 0	SCREW	63	XTB3+8JFZ	005 501 0138 3	SCREW
38	SNE2118	005 500 5011 2	SCREW	64	SHD3X36J	016 634 0164 4	BRACING STRUT
39	SNE2123	005 500 4920 8	SCREW	65	SHE143	016 918 0045 1	FAN
40	SNE2129-1	005 500 7938 6	SCREW	[XB]			
41	SNE4021	005 507 0372 5	NUT	65	XYN3+C6FZ	005 503 0168 7	SCREW
42	XTB3+6FFZ	005 501 1590 3	SCREW	[XA, XB,]			
43	XTB3+8JFZ1	005 501 2523 0	SCREW	[PA, PE]			
[EX, EH, E1]				66	SUS271	016 726 0357 6	SPRING
[EF, EB, EW]				[XB]			
[EK, XL, XA]				67	SME95	016 632 0143 9	ANGLE
[PA, PE, EG]				[XB]			
44	XTB3+8G	005 501 2607 7	SCREW	68	MMN6C2RKM5	002 310 0999 3	DC MOTOR 0.24W
45	XTW3+15T	005 501 1363 4	SCREW	[XB]			
46	XTWS3+8T	005 501 3311 6	SCREW	69	SME97-1	016 632 1309 1	ANGLE
47	XTB3+8FFR	005 501 3569 2	SCREW				
48	XTB3+8JFZ	005 501 0138 3	SCREW				
49	SJT30840LX-V	003 410 5998 9	LUG TERMINAL				
49	SJT31243-V	003 410 7349 8	CONNECTOR				
50	SJT30645JQ	003 410 8079 7	TERMINAL PLATE				
51	SJS50678JQ	003 403 7155 7	CONNECTOR				
52	SJT30345JQ	003 410 8077 9	TERMINAL PLATE				

Ref. No.	Part No.	Part Code	Description	Ref. No.	Part No.	Part Code	Description
PACKINGS				A1	SJA183	003 490 4873 7	POWER CORD
P1	SPP740	016 978 0437 3	PROTECTION COVER	[XB]			
P2	SPG5933	016 971 5033 4	CARTON BOX	A1	SJA188	003 490 5443 1	POWER CORD
[EX, EH, E1]				[EK]			
[EB, EW, EK]				A2	SJP9215	003 402 1437 9	AC PLUG ADAPTOR
[XL, XA, XB]				[XA, XB]			
[PA, PB, EG]				[PA, PE]			
P2	SPG5934	016 971 5072 7	CARTON BOX	A3	SQF12970-1	016 983 5266 3	INSTRUCTION BOOK
[EF]				[EX, EH, E1]			
P3	SPS4914-1	016 977 3328 0	PAD	[EB, EW]			
P4	SPS4915-2	016 977 3344 0	PAD	A3	SQF12971	016 983 5154 0	INSTRUCTION BOOK
P5	SPS4999	016 977 3344 0	PAD	[EK]			
ACCESSORIES				A3	SQF12972-1	016 983 5312 4	INSTRUCTION BOOK
A1	SFDAC05E03	003 490 4809 5	POWER CORD	[EF, XA]			
[EX, EH, E1]				A3	SQF12973	016 983 5238 7	INSTRUCTION BOOK
[EF, EB, EW]				[EG]			
[EG]				A3	SQF12974	016 983 5237 8	INSTRUCTION BOOK
A1	SJA168-1	003 490 4122 9	POWER CORD	[E1]			
[XA]				A3	SQF12975	016 983 5236 9	INSTRUCTION BOOK
[PA, PE]				[XL, XB]			
A1	SJA173	003 490 4161 2	POWER CORD	A3	SQF12976	016 983 5235 0	INSTRUCTION BOOK
[XL]				[PA, PE]			

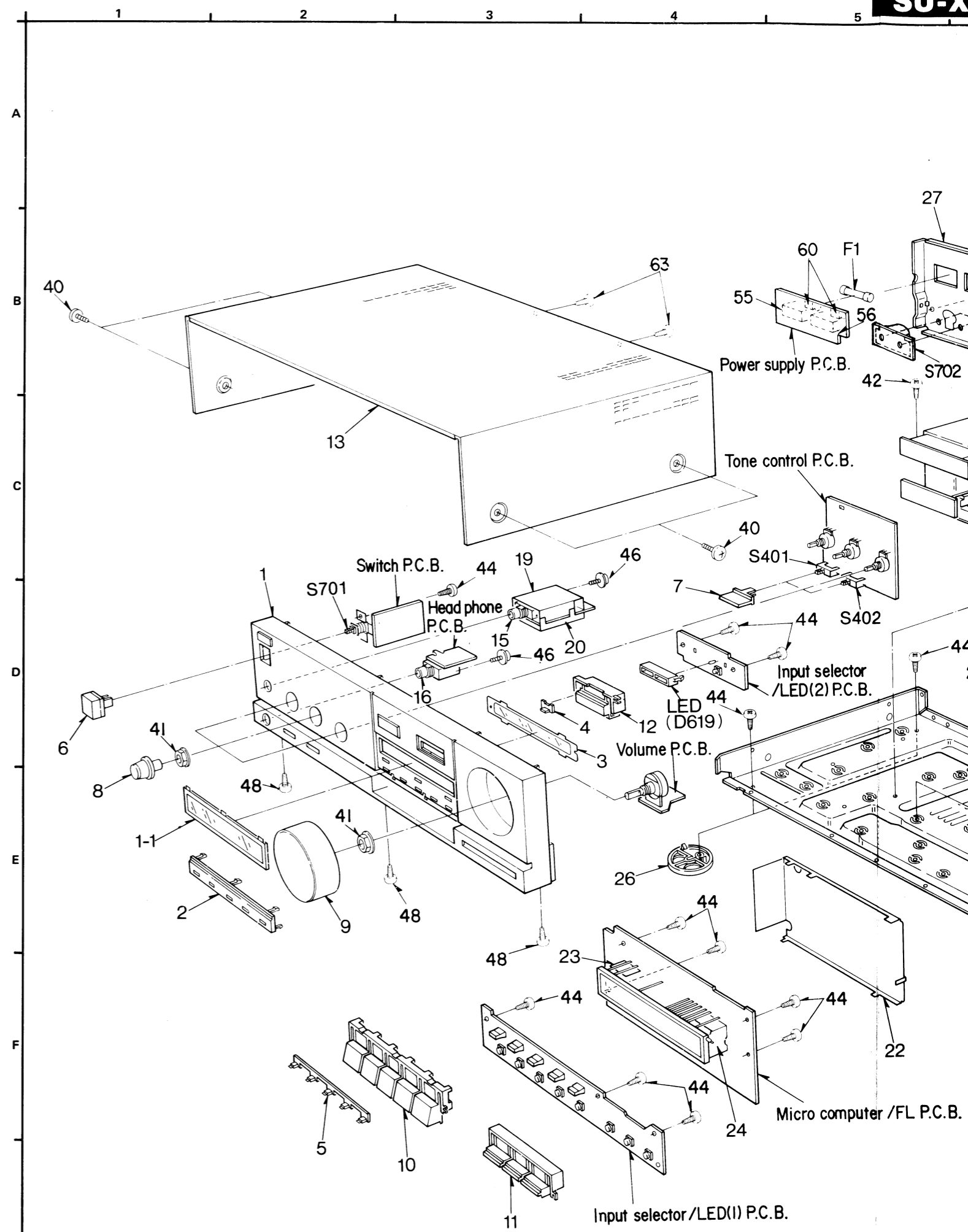

ription

AL

IN

RT

24W

ription

PTOR

N BOOK

N BOOK

N BOOK

N BOOK

N BOOK

N BOOK

N BOOK

