

Service Manual

Amplifier

SU-X920D

Stereo Integrated Amplifier

Colour

(K) Black Type

Simplified

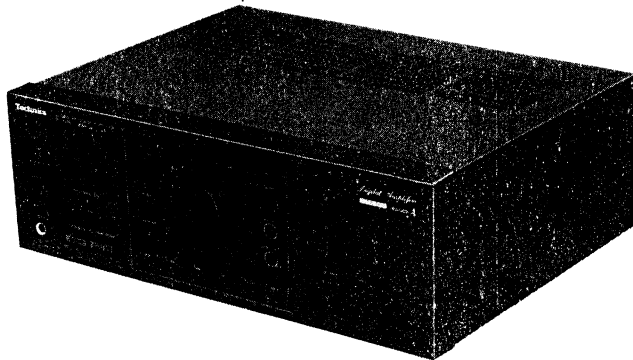

Areas

Suffix for Model No.	Area	Colour
(E)	Europe	(K)
(EB)	Great Britain	
(EG)	Germany and Italy	

• Please file and use this manual together with the Service Manual for Model No. SU-X902, Order No. AD9103052C2.
 • This service manual indicates the main differences between Original SU-X902 (E).

■ LINE-UP OF COMPONENTS

System Name	Unit
SC-X920D (E)	ST-X902LA (E) : Tuner
	SU-X920D (E) : Amplifier
	RS-X920 (E) : Cassette Deck
	— : CD Player
	SL-J110R (E) : Turntable
	SB-CS95 (E) : Speaker (Made in PAES)
SC-X920D (EB)	ST-X902LA (EB) : Tuner
	SU-X920D (EB) : Amplifier
	RS-X920 (EB) : Cassette Deck
	SL-PJ38A (EB) : CD Player (Made in MBV)
	SL-J110R (EB) : Turntable
	SB-CS95 (E) : Speaker (Made in PAES)
SC-X920D (EF)	ST-X902LA (EF) : Tuner (Made in PFS)
	SU-X920D (E) : Amplifier
	RS-X920 (E) : Cassette Deck
	SL-PJ38A (E) : CD Player (Made in MBV)
	SL-J110R (E) : Turntable
	SB-CS95 (E) : Speaker (Made in PAES)

System Name	Unit
SC-X920D (EG)	ST-X902LA (EG) : Tuner
	SU-X920D (EG) : Amplifier
	RS-X920 (EG) : Cassette Deck
	SL-PJ38A (EG) : CD Player (Made in MBV)
	SL-J110R (EG) : Turntable
	SB-CS95 (E) : Speaker (Made in PAES)
SC-X920D (EI)	ST-X902LA (EI) : Tuner (Made in PFS)
	SU-X920D (EG) : Amplifier
	RS-X920 (EG) : Cassette Deck
	SL-PJ38A (EG) : CD Player (Made in MBV)
	SL-J110R (EG) : Turntable
	SB-CS95 (E) : Speaker (Made in PAES)

CHANGES

■ CHANGE IN REPLACEMENT PARTS LIST

SU-X902 (Pages 34--39, 42 of service manual.)

Ref. No.	Part Number		Description	Remarks
	SU-X902 (E)	SU-X920D (E, EB, EG)		
TRANSFORMER(S)				
T1	RTP1P5E004-W	SLT5P288-W	POWER TRANSFORMER	△ (EB)
JACK(S)				
JK902	SJS9333B	SJS9332B	AC OUTLET	△ (EB)
CAPACITORS				
C709	ECEA1HKA2R2B	ECEA1HKN2R2B	CAPACITOR 50 V 2.2μ	
CABINET PARTS				
3	SJP9205-2Y	SJP9205-2T	SHORTING PIN	
5	RGR0105C-A1	RGR0105Q-A	REAR PANEL	(E) Type (A)
		RGR0105C-E2	REAR PANEL	(E) Type (B)
		RGR0105P-A	REAR PANEL	(EB) Type (A)
		RGR0105B-C2	REAR PANEL	(EB) Type (B)
		RGR0105Q-B	REAR PANEL	(EG) Type (A)
		RGR0105C-F2	REAR PANEL	(EG) Type (B)
11	RMA0138	RMA0138-1	PLATE	
13	RGL0094-X	RGL0094-C	PANEL LIGHT	
21	RGU0474A-K	RGU0474B-K	BUTTON, TAPE	
24	SJS9333A	SJS9332A	AC OUTLET COVER	(EB)
28	SYE1128-2	REM0020-1	FAN MOTOR ASS'Y	Type (A)
		SYE1128-4	FAN MOTOR ASS'Y	Type (B)
28-1	---	SHE232-1	FAN	Type (A)
28-3	SUS233	RMQ0209-K	FAN CASE	Type (A)
		SHE233-1	FAN CASE	Type (B)
28-5	SHE234	RMQ0208-K	CAP	Type (A)
28-6	---	SJT783	TERMINAL	Type (B)
28-7	---	SJS5215	CONNECTOR (2P)	Type (B)
28-8	---	RMQ0212-K	TERMINAL CAP	Type (A)
35	RFKGUX902E-K	RFKGUX920DEK	FRONT PANEL ASS'Y	
40	---	RJS1A7402	CONNECTOR (2P)	Type (A)
41	---	XTBS3+8JFZ1	SCREW	Type (A)
PACKING MATERIALS				
P1	RPG0841	RPG1205	PACKING CASE	
P3	SPSD152	---	ACCESSORIES BOX	
ACCESSORIES				
A1	RQF1096	---	INSTRUCTIONS MANUAL ASS'Y	(E)
A1-1	RFKSUX502E-K	RQT1494-B	INSTRUCTIONS MANUAL	(EB)
		RQT1493-D	INSTRUCTIONS MANUAL	(EG)
		RFKSCX520DEK	INSTRUCTIONS MANUAL	(E)
A2	SJA187	---	AC POWER SUPPLY CORD	△ (E)

■ CONNECTIONS OF EACH UNIT

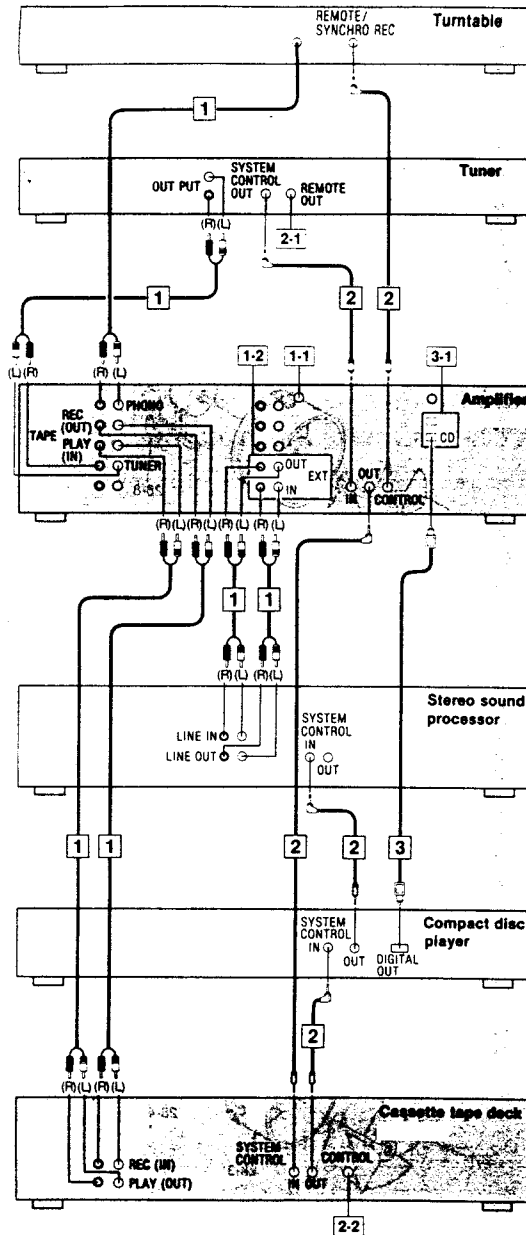

Connection diagrams shown are for connections to a Technics hi-fi component system. Make connections in the numbered sequential order.

- 1 Connect the stereo connection cables** (included with the turntable, tuner, stereo sound processor, and cassette tape deck).

Stereo connection cable

White (L) →
Red (R) →

1-1

"GND" terminal of the amplifier

This terminal is for use with a turntable which has a ground wire.

1-2

"EXT" terminals of the amplifier

When these terminals are not in use, be sure to insert the "shorting" pins (included).

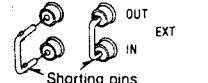

- 2 Connect the L-type cable** (included with the turntable, tuner, stereo sound processor, compact disc player, and cassette tape deck).

2-1

"REMOTE OUT" terminal

This terminal is used to connect to the "REMOTE IN" terminal of the Technics multi-compact disc player (not included).

2-2

"CONTROL" terminal

Make a connection from this terminal to the "CONTROL" terminal of a cassette deck on a Technics multi compact disc player. (For detailed information, refer to the operating instructions of the Technics multi compact disc player.)

- 3 Connect the optical-fiber cable** (included with the compact disc player).

3-1

"DIGITAL IN" (CD, DAT) terminals of the amplifier

These terminals are protected by the dust-protection caps to avoid damage by the dust, etc. Remove the caps only when the "DIGITAL IN" terminals are to be used.

When these terminals are not being used, attach the caps as shown in the illustration below.

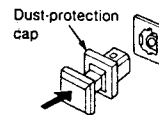

- **Connect the AC power supply cords and AC outlet**

(See page 3 of service manual RS-X920, Order No. AD9203069A2.)

- There are two types of the fan motor, i.e.: Types A and B.

Type A...The fan motor terminal is a connector type.

The "mark Ⓐ" is printed on the main P.C.B. of type A. (Refer to the diagram below.)

Type B...The fan motor terminal is a lead wire type.

Refer to the diagram below to distinguish type A from type B.

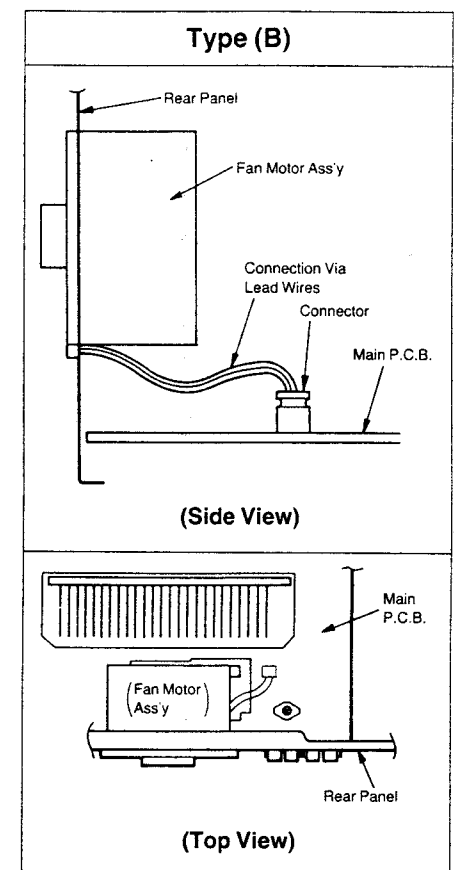
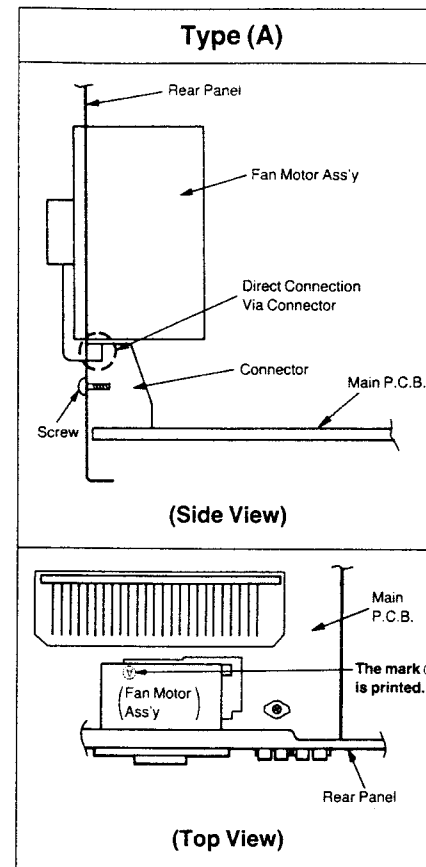

DISASSEMBLY INSTRUCTIONS

Ref. No. 14	Removal of the Fan Motor Ass'y (Type A)
Procedure 1→8→14	

1. Release the 3 claws. (See Fig. 1.)
2. Insert a screwdriver at the root of the fan. Force it out of the motor shaft. (See Fig. 2.)
3. Remove the cap by using ⊖ screwdriver. (See Fig. 3.)
4. Remove the terminal cap in the direction of arrow. (See Fig. 4.)
5. Remove the motor from the fan case. (See Fig. 5.)
6. When mounting the motor, align the fan casing's projection with the hole of the motor. (See Fig. 6.)

Ref. No. 14	Removal of the Fan Motor Ass'y (Type B)
Procedure 1→8→14	

1. Remove the 1 connector (J551).
2. Release the 3 claws. (See Fig. 1.)
3. Insert a screwdriver at the root of the cooling fan. Force it out of the motor shaft. (See Fig. 2.)
4. Remove the cap by using ⊖ screwdriver. (See Fig. 3.)
5. Remove the motor from the fan casing. (See Fig. 4.)
6. When mounting the motor fan, align the fan casing's projection with the hole of the motor. (See Fig. 5.)

CABINET PARTS LOCATION

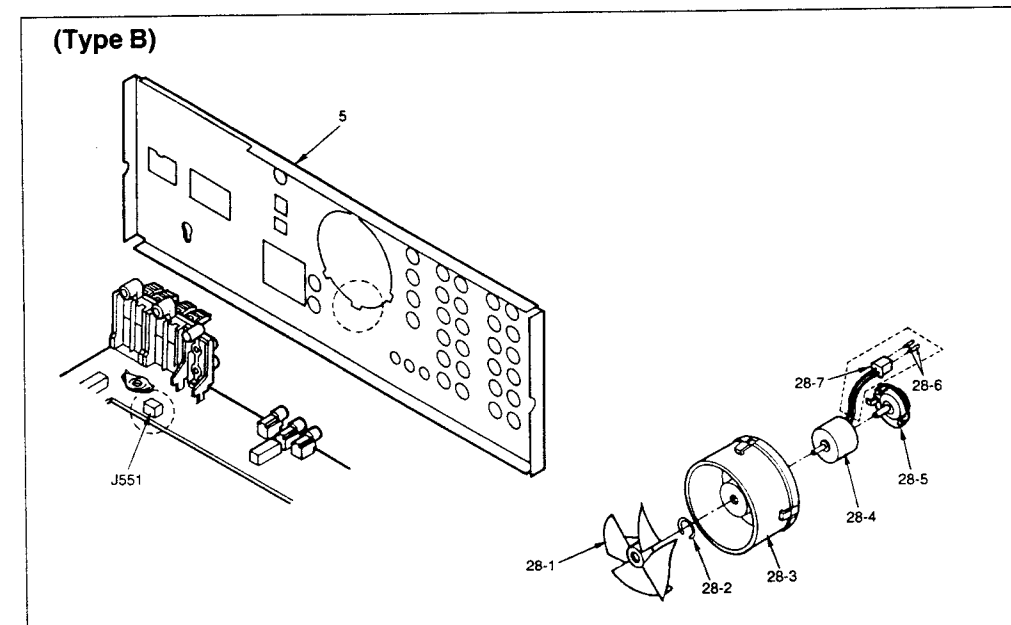
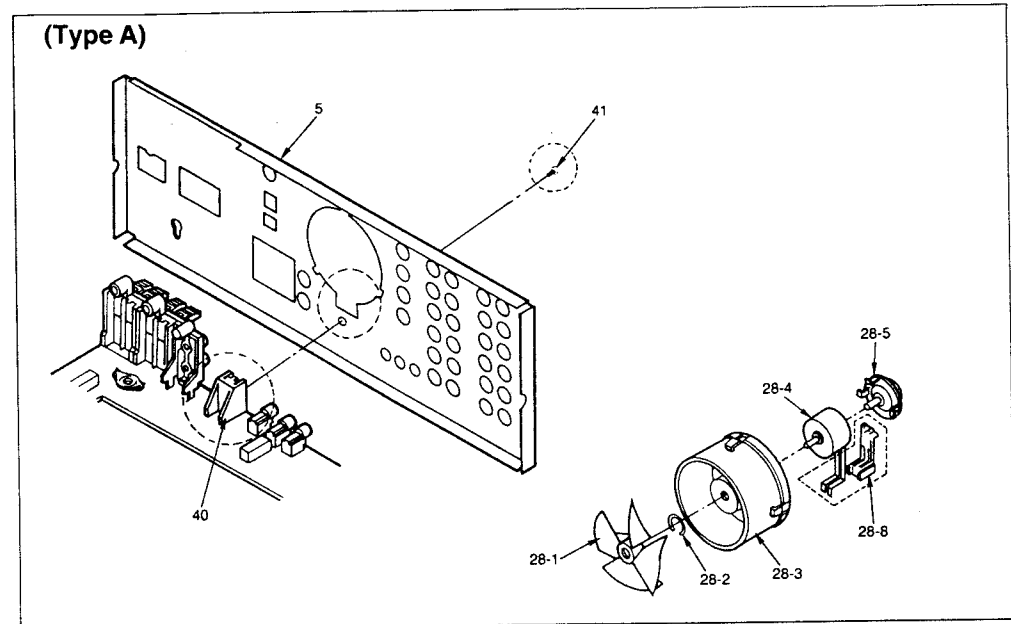

Note: The different parts between type A and type B are enclosed by the dot lines in the above diagrams.

CONTENTS

	Page		Page
Before repair	2	Circuit board diagram	22~27
Protection circuitry	2	Terminal guide of IC's, transistors and diodes	27
Accessories	2	Wiring connection diagram	28
Location of controls	3	Function of IC terminals	29, 30
Connections	4~7	Block diagram	31~33
Digitalization of audio signals	8	Replacement parts list	34~39, 42
Disassembly instructions	9~12	Cabinet parts location	40, 41
Schematic diagram	13~21	Packaging	42
Description of FL panel	21		

BEFORE REPAIR

- Turn off the power supply. Using a 10Ω, 5 W resistor connect both ends of power supply capacitors (C711, C712, 3300 μF) in order to discharge the voltage.
- Before turning the power supply on, after completion of repair, slowly apply the primary voltage by using a power supply voltage controller to make sure that the consumed current at 50 Hz/60 Hz in NO SIGNAL mode should be shown below with respect to supply voltage 220 V/240 V.

Power supply voltage	AC 230 V	AC 240 V
Consumed current 50 Hz	198~463 mA	186~434 mA
Consumed current 60 Hz	192~448 mA	181~422 mA

PROTECTION CIRCUITRY

The protection circuitry may have operated if either of the following conditions is noticed:

- *No sound is heard when the power is switched ON.
- *Sound stops during a performance.

The function of this circuitry is to prevent circuitry damage if, for example, the positive and negative speaker connection wires are "shorted", or if speaker systems with an impedance less than the indicated rated impedance of this unit are used.

If this occurs, follow the procedure outlined below:

- Switch OFF the power.
- Determine the cause of the problem and correct it.
- Switch ON the power once again.

Note:

When the protection circuitry functions, the unit will not operate unless the power is first switched OFF and then ON AGAIN.

ACCESSORIES

- AC power supply cord 1
Configuration of AC power supply cord differs according to area.

SJA187 For (E) (EG) area only
SJA188 For (EB) area only.

LOCATION OF CONTROLS

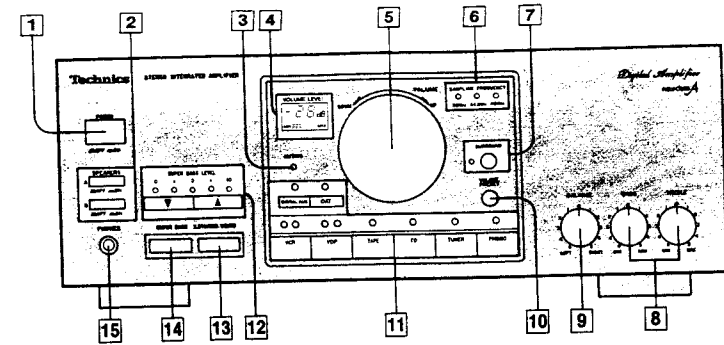

- | | |
|-------------------------------------------------------------|--------------------------------------------------------------------------|
| 1 Power switch (POWER) | 9 Balance control (BALANCE) |
| 2 Speaker selectors (SPEAKERS) | 10 Volume preset button (VOLUME PRESET) |
| 3 Muting indicator (MUTING) | 11 Input selectors/indicators |
| 4 Volume-level indicator (VOLUME LEVEL) | 12 Super bass level control buttons/indicators (SUPER BASS LEVEL) |
| 5 Volume control (VOLUME) | 13 Super dynamic sound button/indicator (S. DYNAMIC SOUND) |
| 6 Sampling frequency indicators (SAMPLING FREQUENCY) | 14 Super bass button/indicator (SUPER BASS) |
| 7 Surround-sound button/indicator (SURROUND) | 15 Headphones jack (PHONES) |
| 8 Tone controls (BASS/TREBLE) | |

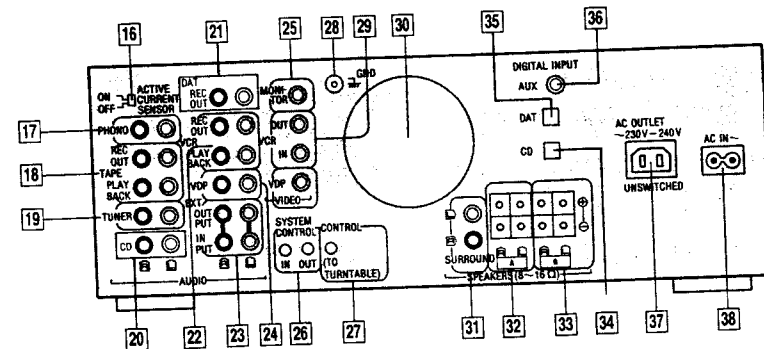

- | | |
|-------------------------------------------|-------------------------------------------|
| 16 Active current sensor switch | 28 GND terminal |
| 17 Phono input terminal | 29 VCR out/in terminal |
| 18 Tape rec out/playback terminal | 30 Cooling fan |
| 19 Tuner input terminal | 31 Surround-sound speaker terminal |
| 20 CD input terminal | 32 Main speaker A terminal |
| 21 DAT recout terminal | 33 Main speaker B terminal |
| 22 VCR recout/playback terminal | 34 CD digital input terminal |
| 23 EXT output/input terminal | 35 DAT digital input terminal |
| 24 VDP input terminal | 36 AUX digital input terminal |
| 25 MONITOR terminal | 37 AC outlet |
| 26 System control IN/OUT terminal | 38 AC inlet |
| 27 Control terminal (to turntable) | |

■ CONNECTIONS

Make connections to each component in the system by using stereo connection cables (not included). See the operating instructions of the tuner (ST-X902L) for details.

Stereo connection cable
White (L)
Red (R)

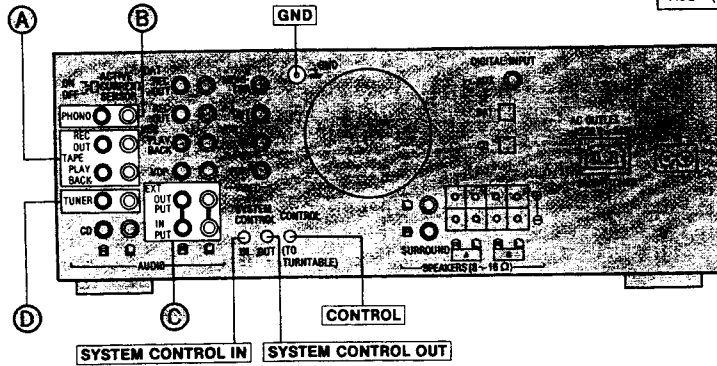

Connecting audio components

A "TAPE" terminals

Connect a tape deck.

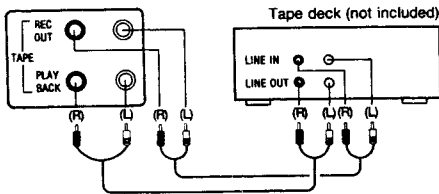

■ "SYSTEM CONTROL" terminal

This terminal is used to connect a Technics tape deck with the "SYSTEM CONTROL IN" terminal.

B "PHONO" terminals

Connect a turntable.

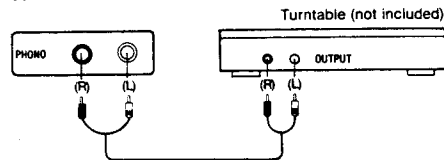

■ "GND" terminal

This terminal is for use with a turntable which has a ground wire.

■ "CONTROL" terminal

This terminal is used to connect a Technics turntable with the "REMOTE/SYNCHRO REC" terminal.

C "EXT" terminals

Connect a stereo sound processor.

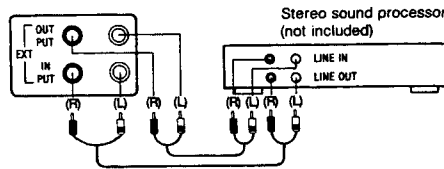

Note:

When these terminals are not in use, be sure to insert the "shorting" pins (included).

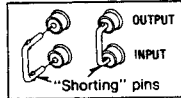

D "TUNER" terminals

Connect a tuner.

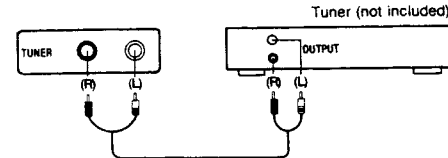

■ "SYSTEM CONTROL IN" terminal

This terminal is used to connect a Technics tuner with the "SYSTEM CONTROL OUT" terminal.

Make connections to each component by using stereo connection cables (not included) and video connection cables (not included).

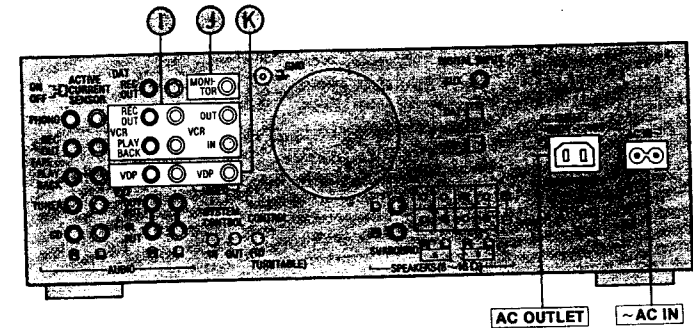

Connecting video equipment

I "VCR" terminals

Connect a VCR.

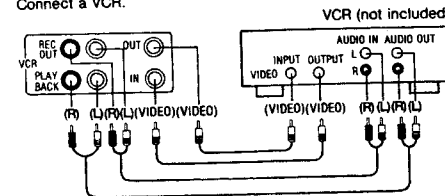

J "MONITOR" terminal

Connect a TV.

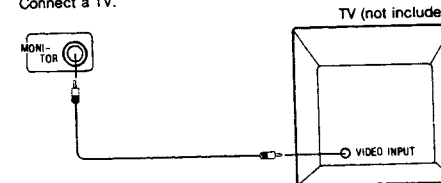

K "VDP" terminals

Connect a video disc player.

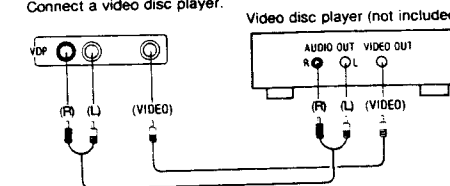

AC outlet ("AC OUTLET")

Do not connect video equipment (such as a TV, etc.) to the AC outlet of this unit. (This outlet is intended for audio equipment.) Do not exceed the indicated power ratings when connecting to this outlet.

"UNSWITCHED" outlet:

Power is always available, regardless of power switch. Audio equipment rated up to 60 W can be connected here.

Note:

The configuration of the AC outlet differs according to area.

AC power supply cord

Connect the AC power supply cord (included) after all other cables and cords are connected.

Notes:

- Configuration of the AC outlet and AC power supply cord differs according to area.
- If this unit is not to be connected with the tuner, the cord is to be connected to the household AC outlet.

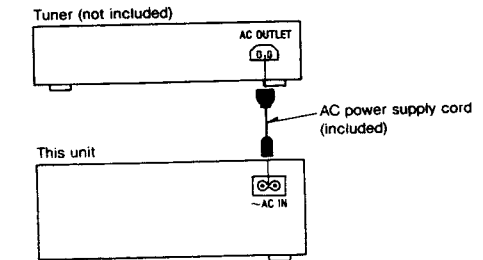

For United Kingdom

Cut off and dispose of the plug and replace with a suitable plug.

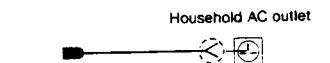

Fit a suitable plug to the AC power supply cord.

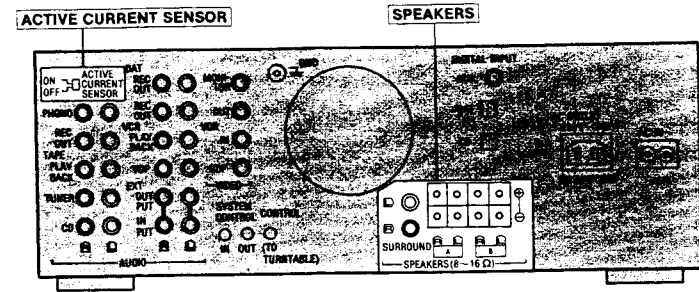
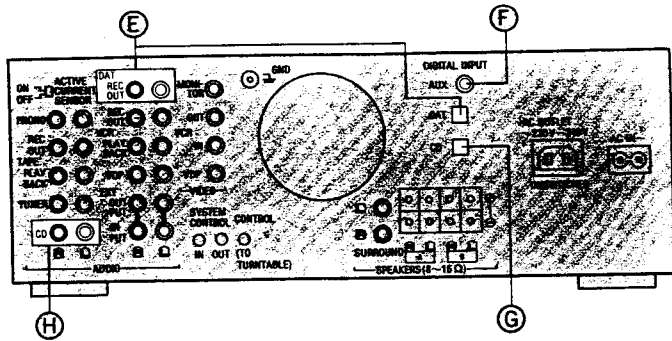

Connecting audio components

E "DAT" terminals (ANALOG/DIGITAL)

Connect a digital audio tape deck.
Recordings can be made to the digital audio tape deck.

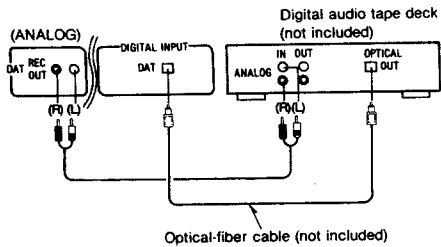

G "CD" terminal (DIGITAL)

Connect a compact disc player.

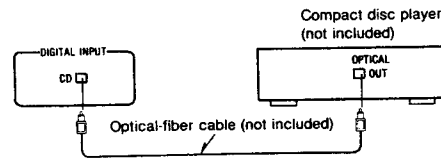

F "AUX" terminal (DIGITAL)

Connect a second compact disc player, etc.

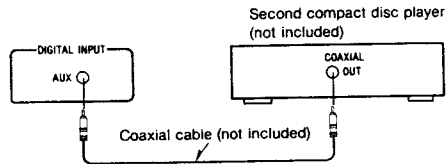

H "CD" terminals (ANALOG)

Connect a compact disc player.

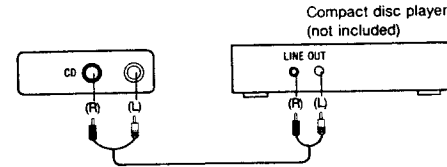

"DIGITAL INPUT" (DAT, CD) terminals of this unit

These terminals are protected by dust-protection caps to avoid damage by dust, etc. Remove the caps only when the "DIGITAL INPUT" terminals are to be used. When these terminals are not being used, attach the caps as shown in the illustration at right.

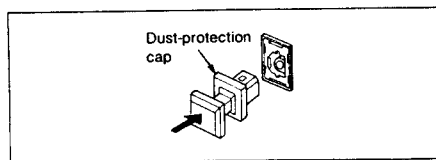

Connection of speaker systems

Three pairs of speaker systems (main, second, surround-sound) can be connected to this unit.

Speaker systems that can be connected to any of the speaker connection terminals of this unit are speaker systems with an impedance of 8 to 16 ohms. Make connections to each speaker system by using speaker cords (not included).

Main speaker systems (not included)

Connect to the "A" terminals.

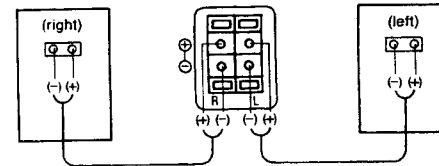

Second speaker systems (not included)

Connect to the "B" terminals.

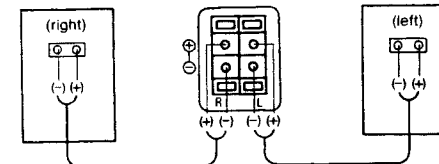

Surround-sound speaker systems (not included)

Connect to the "SURROUND" terminals.

• Be sure to connect both speaker systems. If only one side is connected, no sound will be heard.

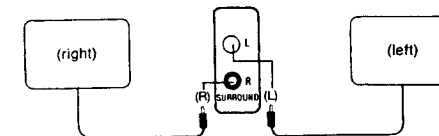

How to use the active current sensor

The selector is used to enjoy powerful super-bass sound. **ON:** Switch ON when connecting the Technics system speakers (SU-X902: SB-CS90, SU-X502: SB-CS90/CS70). **OFF:** Switch OFF when connecting speakers other than Technics system speakers.

Notes:

- When connecting speakers other than system speakers, sound from the speakers may not be heard if the selector is pressed ON, because the protecting circuit on the amplifier becomes active.
- The active current sensor activates only for the speaker systems connected to the "A" terminals.

To connect cords to terminals

- 1 Strip off the outer covering, and twist the center conductor. 15 mm (19/32") Twist
- 2 Tilt the lever back and insert the cord. 2
- 3 Close the lever and pull the cord gently to be sure that it is secure.

Note:

Be sure to only connect positive (+) cords to positive (+) terminals, and negative (-) cords to negative (-) terminals.

Note:

To prevent damage to circuitry, never short-circuit the plus (+) and minus (-) speaker wire.

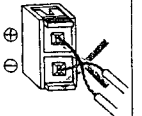

■ DIGITALIZATION OF AUDIO SIGNALS

■ Why digitize?

- Audio signals are analog signals with a continuous form.
- When these audio signals are subjected to repeated electronic processing (recording, playback, etc.), they become noisy and distortion occurs, thus resulting in deterioration of the sound quality.
- When these signals are first digitized before processing, they have the following advantages that prevent deterioration of the sound quality:
 - ① Resistance to noise
 - ② Extremely low distortion
 - ③ Flat, even frequency response

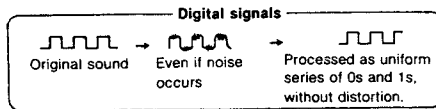
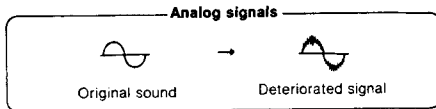

■ How signals are digitized

If it is known to what degree of minuteness the human ear can distinguish sounds, it is then possible, by using that data as the standard reference, to digitize them by dividing analog signals into minute pieces, after which they can be transmitted with a high degree of precision, and thereafter recorded and played back in the digitized format.

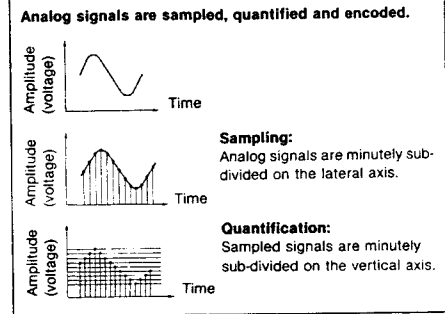

Digitalization example (recording to CD and play of CD)

Recording to CD



CD play

Former method

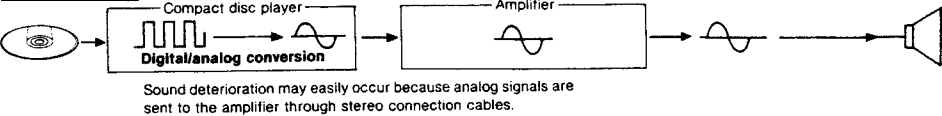

This method

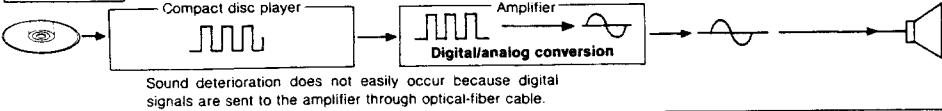

What the sampling frequency is

The sampling frequency expresses the degree of minuteness to which signals can be cut, relative to a certain specified time interval, during sampling.
For compact disc sound:
Analog signals are cut 44,100 times (i.e., 44.1 kHz) during one second.
This 44.1 kHz is, therefore, the sampling frequency for compact disc sound.

What analog/digital conversion is

Audio signals (analog signals) are taken out (sampled) at certain fixed time intervals. The points at which this sampling frequency occurs are digitally encoded and converted to digital signals.

What digital/analog conversion is

Each sampling frequency point is returned (converted) to voltage, thus converting digital signals to the analog signals that we can hear.

■ DISASSEMBLY INSTRUCTIONS

Ref. No. 1	Removal of the Cabinet	Ref. No. 2	Removal of the Front Panel Unit
Procedure 1			
<p>1. Remove the 6 screws (①-⑥).</p> <p>2. Remove the cabinet in the direction of the arrow.</p>		Procedure 1→2	<p>1. Remove the 2 connectors (J501, J502).</p> <p>—Removal of the Connector—</p> <p>Flat cable Connector</p>
Ref. No. 3	Removal of the Power Switch/Speaker Select Switch P.C.B.		
Procedure 1→2→3	<p>Power switch/Speaker select switch P.C.B.</p>		
<p>•Remove the 2 screws (①, ②).</p>		Procedure 1→2→3	<p>2. Remove the 3 screws (①-③).</p> <p>3. Remove the front panel unit in the direction of the arrow.</p>
Ref. No. 4	Removal of FL Drive P.C.B.		
Procedure 1→2→4			
<p>1. Remove the 4 knobs (①-④).</p> <p>2. Remove the 4 nuts (⑤-⑧).</p>		Procedure 3→4	<p>3. Remove the 3 screws (⑨-⑪).</p> <p>4. Remove the 3 connectors (J631A, J632A, J633A).</p> <p>A=11 mm B=16 mm C=longer than 22 mm</p> <p>•Use a wrench of the dimensions shown in the illustration above to remove nuts.</p>

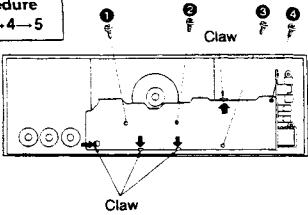
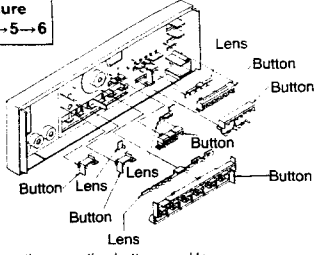
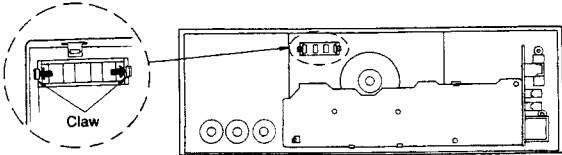
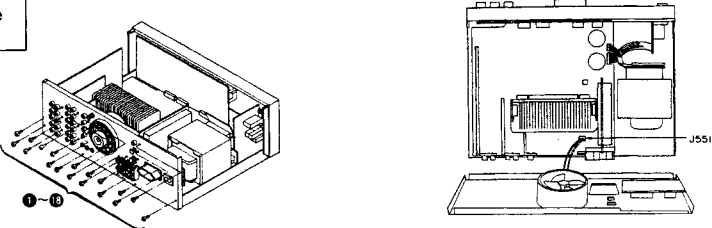
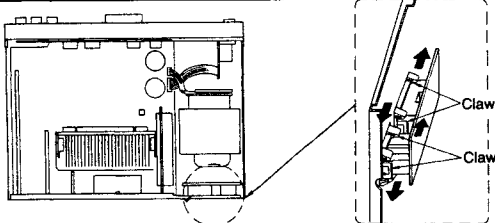
<p>Ref. No. 5</p>	<p>Removal of the Operation P.C.B.</p>	<p>Ref. No. 6</p>	<p>Removal of the Operation Buttons</p>
<p>Procedure 1→2→4→5</p>	 <p>1. Remove the 4 screws (①~④). 2. Release the 4 claws in the direction of the arrow.</p>	<p>Procedure 1→2→4→5→6</p>	 <p>●Pull out the operation buttons and lens.</p>
<p>Ref. No. 7</p>	<p>Removal of the Sampling Frequency Indicator Lens</p>		
<p>Procedure 1→2→4→7</p>	 <p>●Release the 2 claws.</p>		
<p>Ref. No. 8</p>	<p>Removal of the Rear Panel</p>		
<p>Procedure 1→8</p>	 <p>1. Remove the 18 screws (①~⑱). 2. Release the connector (J551).</p>		
<p>Ref. No. 9</p>	<p>Removal of the AC OUTLET/AC IN P.C.B.</p>		
<p>Procedure 1→9</p>	 <p>●Release the 4 claws.</p>		

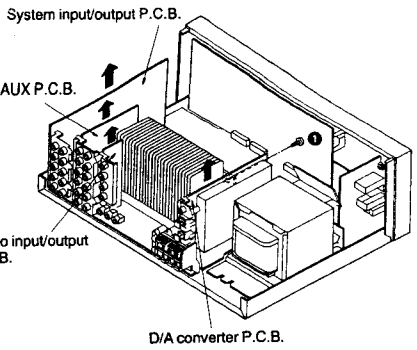
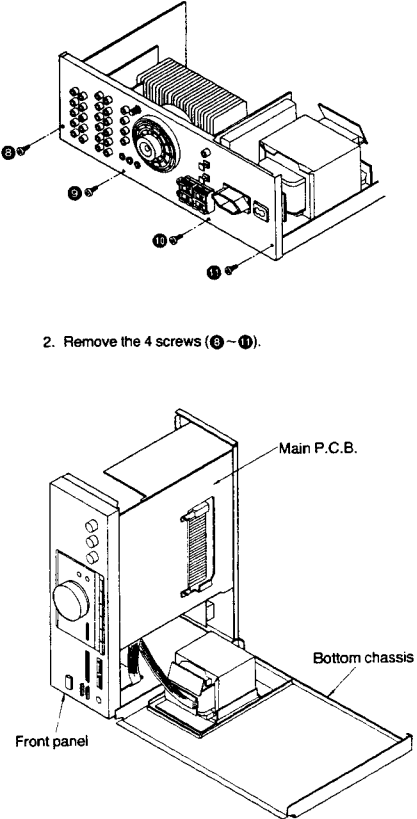
Ref. No. 10	Removal of the P.C.B.s	
Procedure 1→8→10	<ul style="list-style-type: none"> ■ Removal of the D/A converter P.C.B. <ol style="list-style-type: none"> 1. Remove the screw (1). 2. Remove the D/A converter P.C.B. in the direction of the arrow. ■ Removal of the other P.C.B. <ul style="list-style-type: none"> ● Remove the P.C.B. in the direction of the arrow. 	
Ref. No. 11	Check of the main P.C.B.	
Procedure 1→11	<ol style="list-style-type: none"> 1. Remove the 7 screws (1-7). 2. Remove the 4 screws (8-11). 3. Remove the 3 screws (12-14). 4. Remove the front panel unit in the direction of the arrow. *Connect 2 flat cables (J501A, J502). 5. Remove the bottom chassis. 6. Reinstall the front panel unit to the main P.C.B. 	

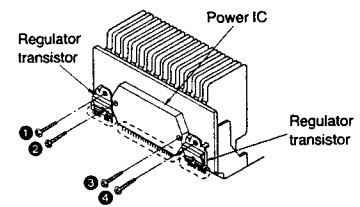
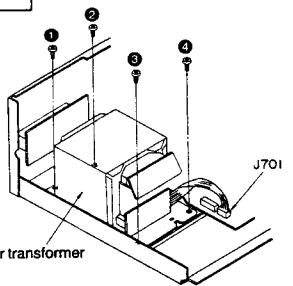
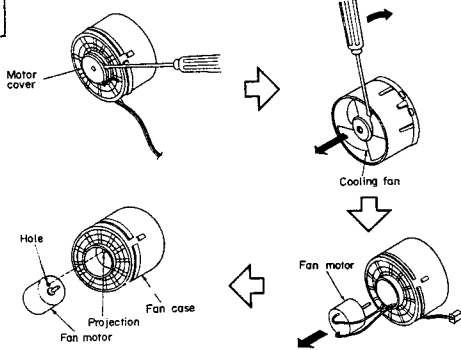
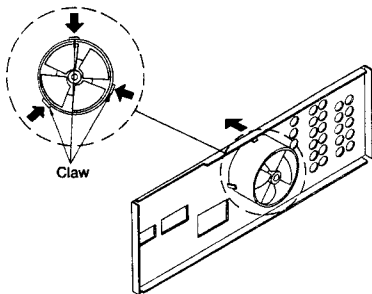
Ref. No. 12	Removal of the Power IC and Regulator Transistor	Ref. No. 13	Removal of the Power Transformer
Procedure 1→11→12	<ol style="list-style-type: none"> 1. Unsolder the power IC or regulator transistor. 2. Remove the 4 screws (1-4).  <p>Note: When mounting the power IC, or regulator transistor apply silicon terminal compound (SZZ0L15) to the rear of the power IC or regulator transistor.</p>	Procedure 1→13	 <ol style="list-style-type: none"> 1. Remove the 1 flat cable (J701). 2. Remove the 4 screws (1-4).
Ref. No. 14	Removal of the Fan Motor	 <ol style="list-style-type: none"> 3. Insert a screwdriver at the root of the cooling fan. Force it out of the motor shaft. 4. Remove the motor cover by used ⊖ screwdriver. 5. Remove the motor from the fan casing. 6. When mounting the motor fan, align the fan casing's projection with the hole of the fan motor. 	
Procedure 1→8→14	 <ol style="list-style-type: none"> 1. Remove the 1 connector (J209). 2. Release the 3 claws. 		

“ATTENTION SERVICER”

Some chassis components may have sharp edges. Be careful when disassembling and servicing.

●Replacement of the Foot.

1. Remove the 4 heat melted posts on the chassis with a pair of nippers or similar tool.
2. To replace the foot (RKA0011-2) on the chassis, melt the 4 posts with a soldering iron.

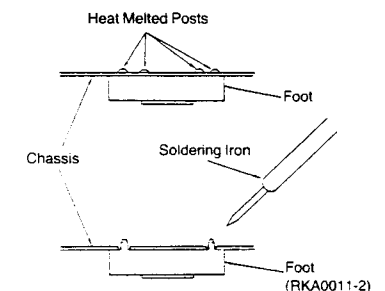

SCHEMATIC DIAGRAM

A FL DRIVE CIRCUIT

B OPERATION SWITCH CIRCUIT

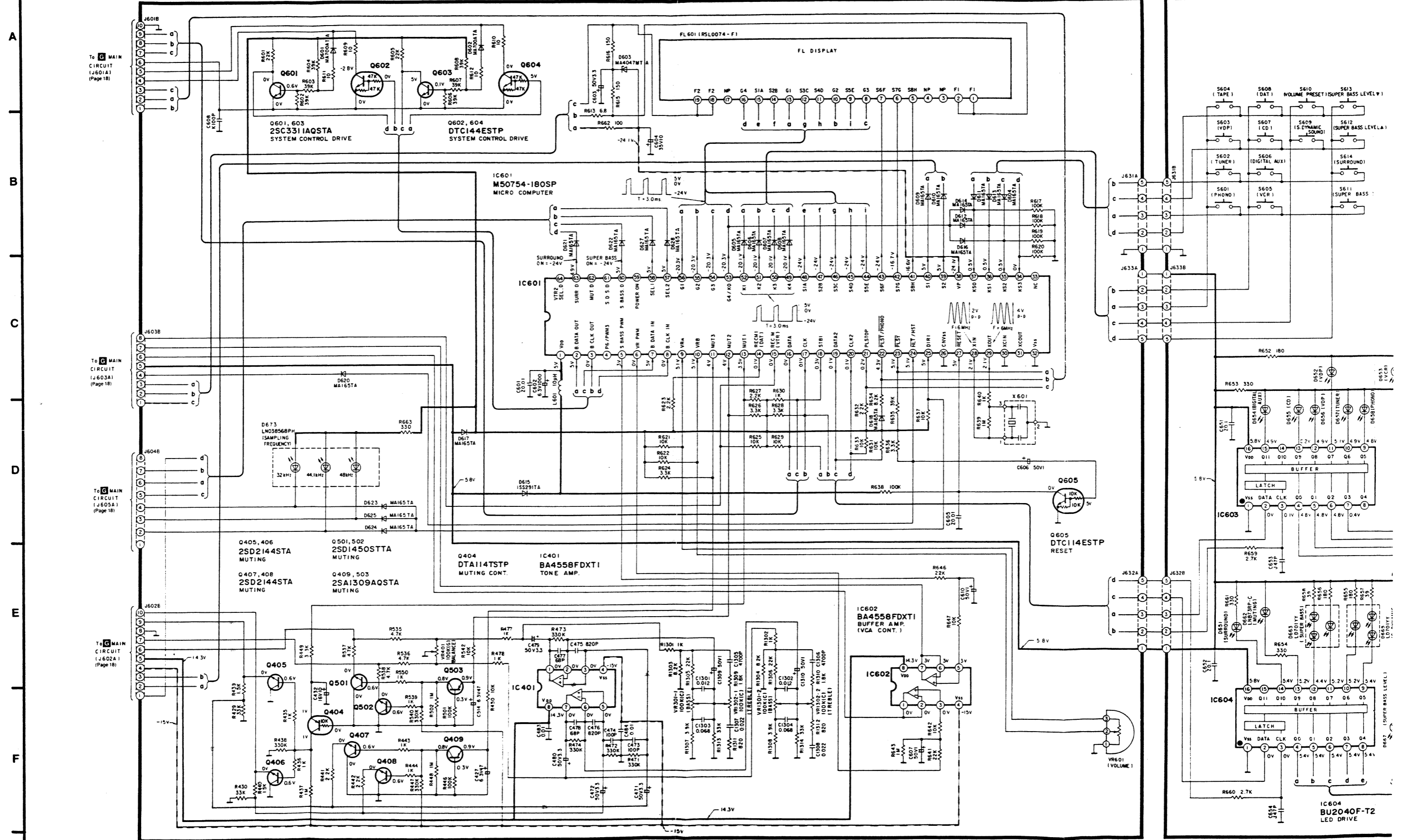

3 4 5 6 7 8 9 10 11 12

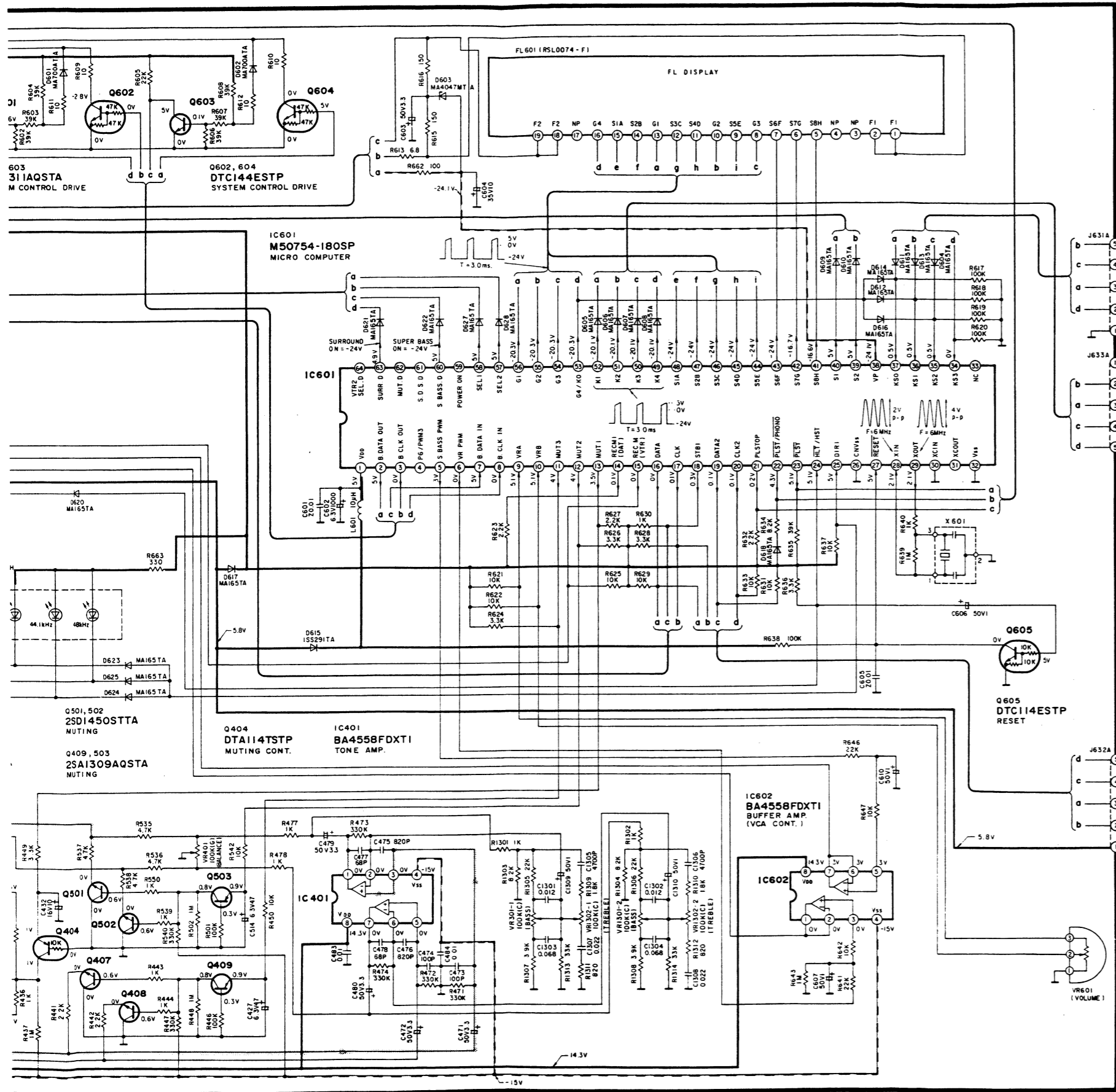

B OPERATION SWITCH CIRCUIT

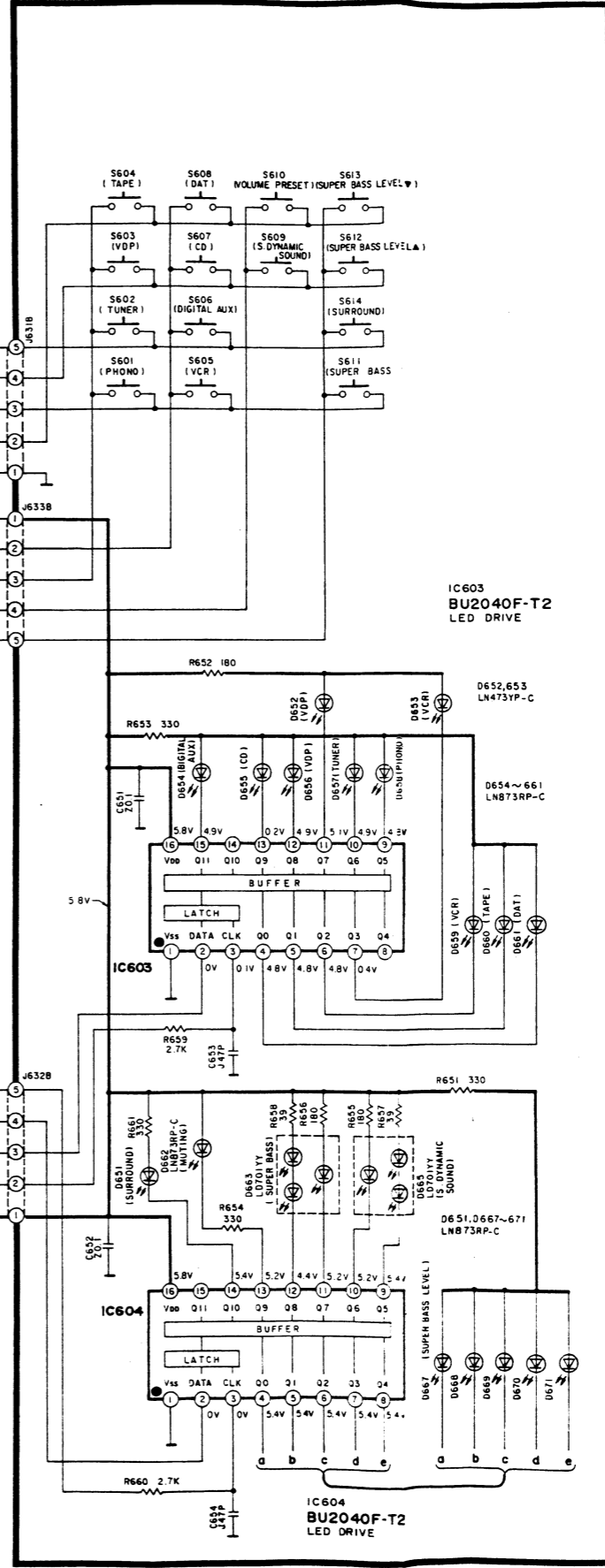

SCHEMATIC DIAGRAM

1 2 3 4 5 6 7 8 9 10

A

B

C

D

E

F

C D/A CONVERTER CIRCUIT

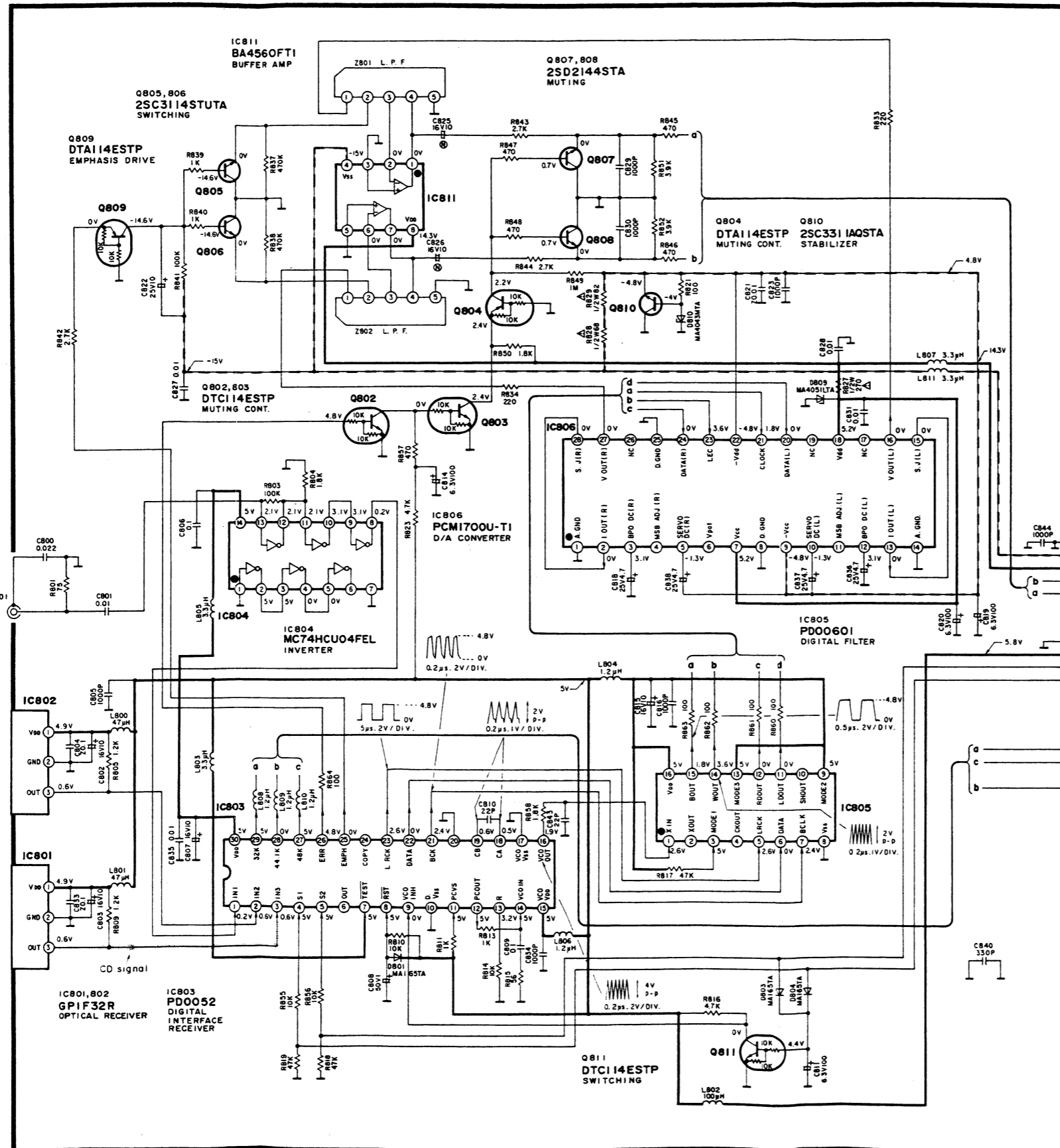

D VIDEO IN/OUT TERMINAL CIRCUIT

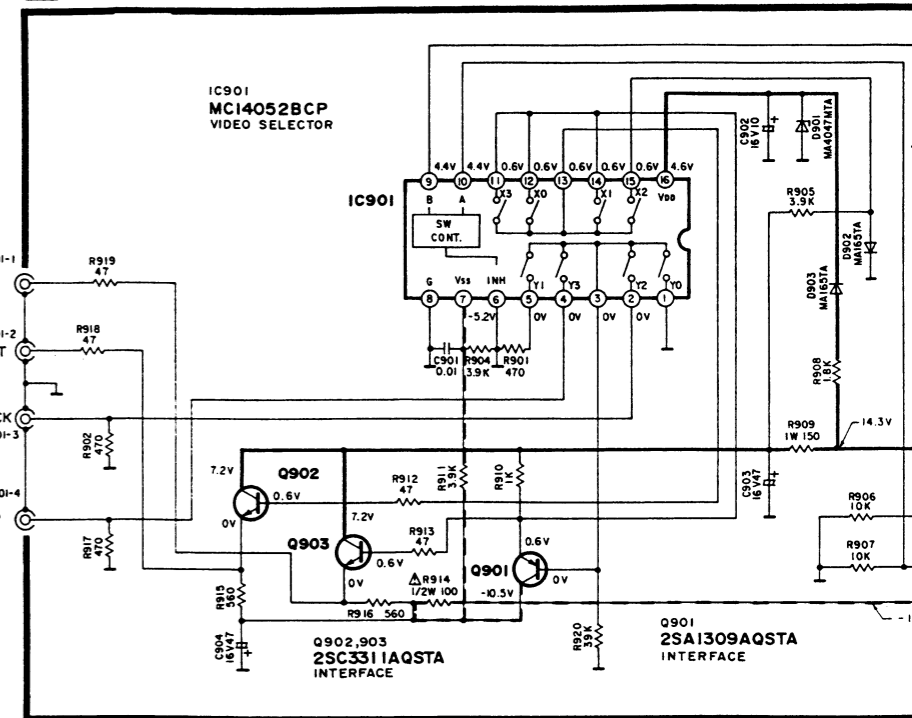

E INPUT/OUTPUT TERMINAL CIRCUIT

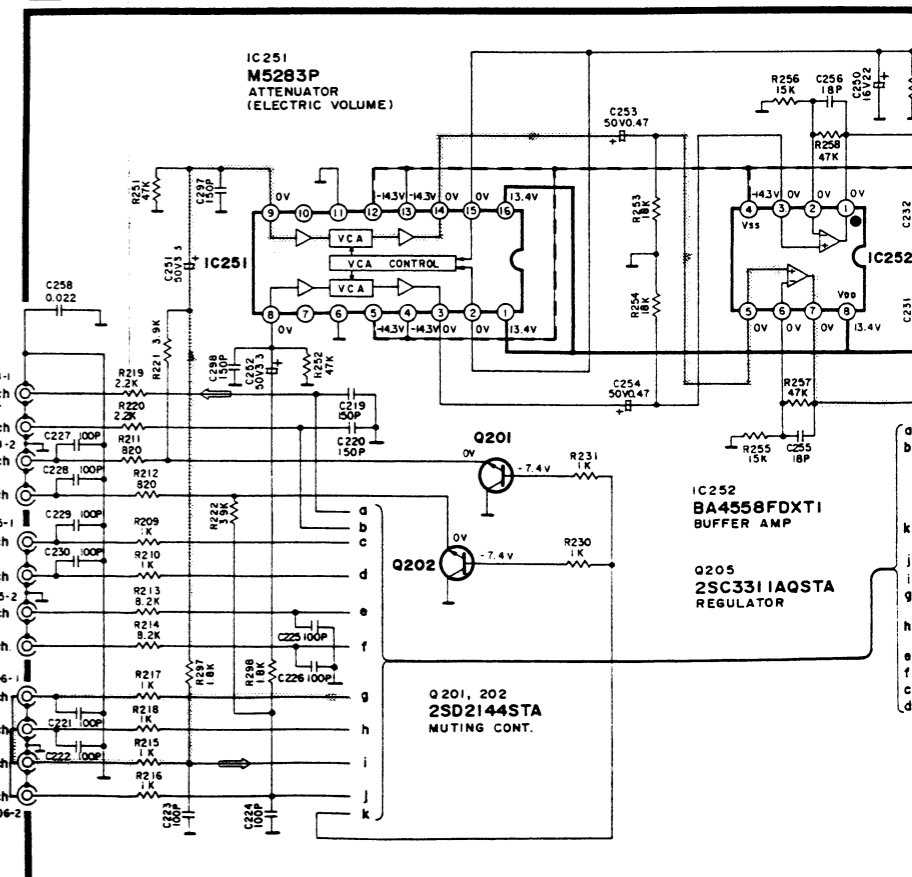

9

10

11

12

13

14

15

16

17

18

AL CIRCUIT

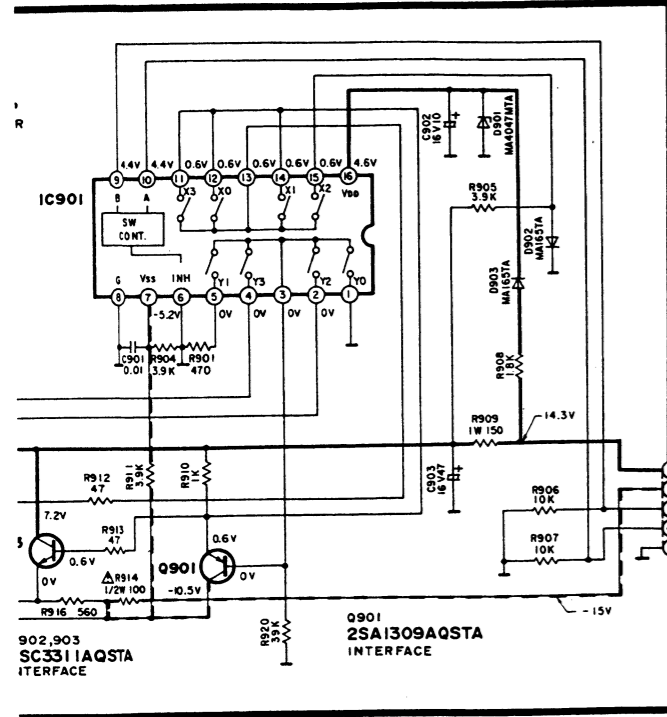

NAL CIRCUIT

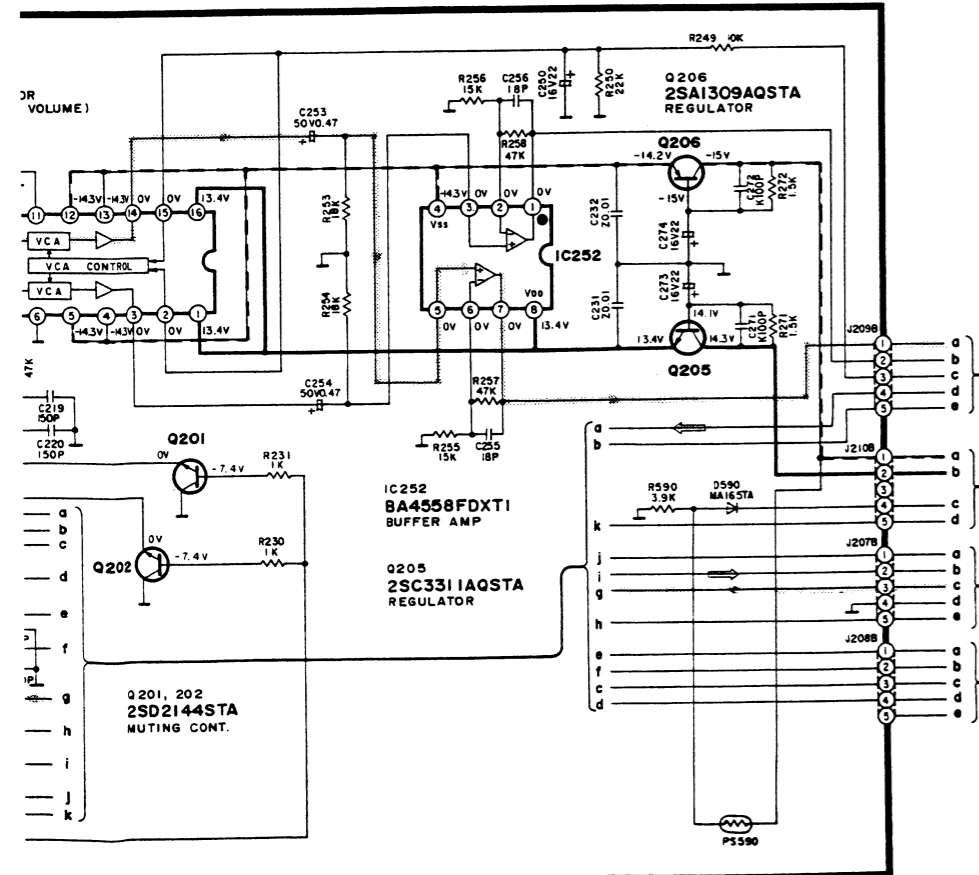

F PHONO/TAPE/TUNER/CD TERMINAL CIRCUIT

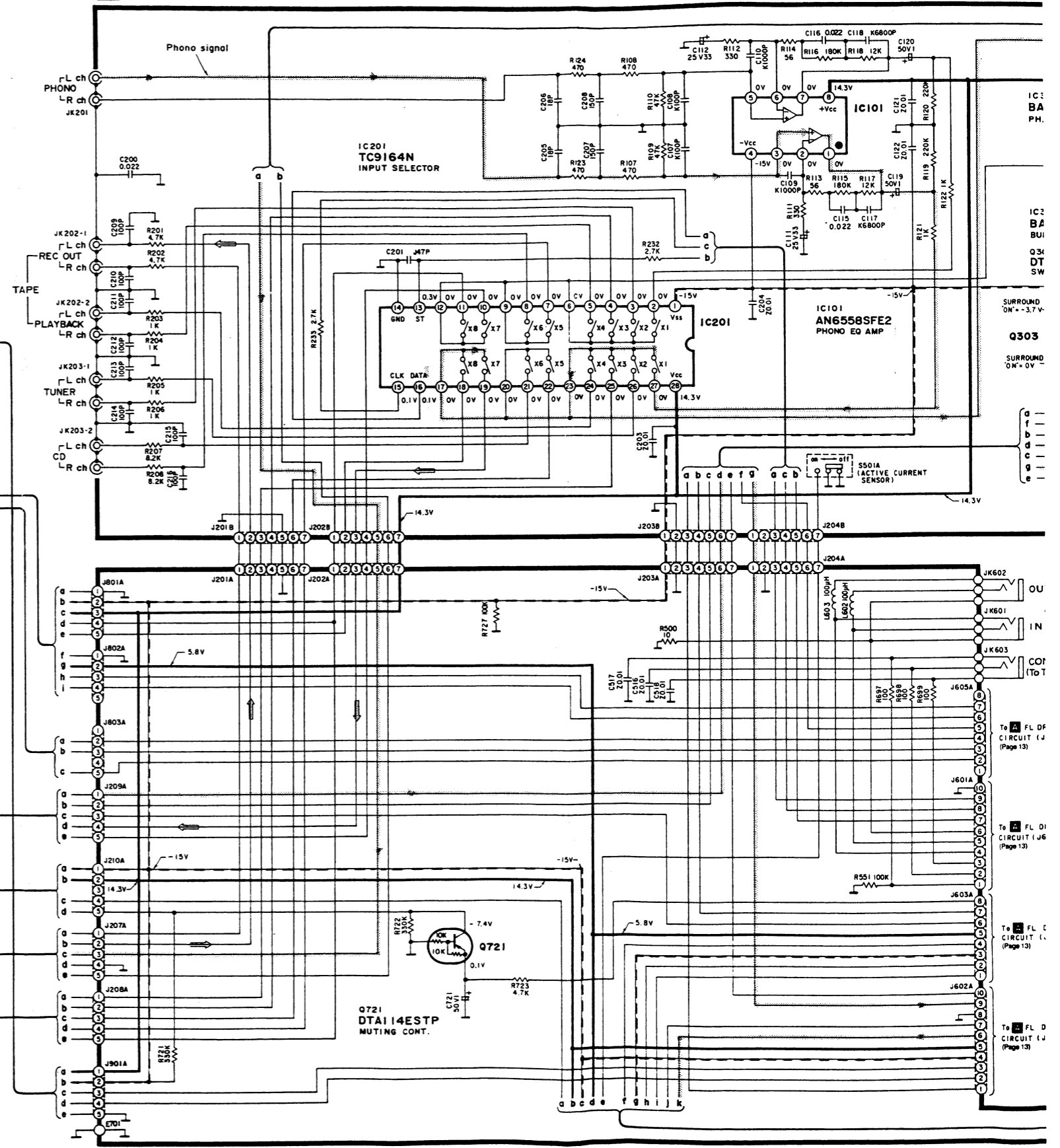

G MAIN CIRCUIT

F PHONO/TAPE/TUNER/CD TERMINAL CIRCUIT

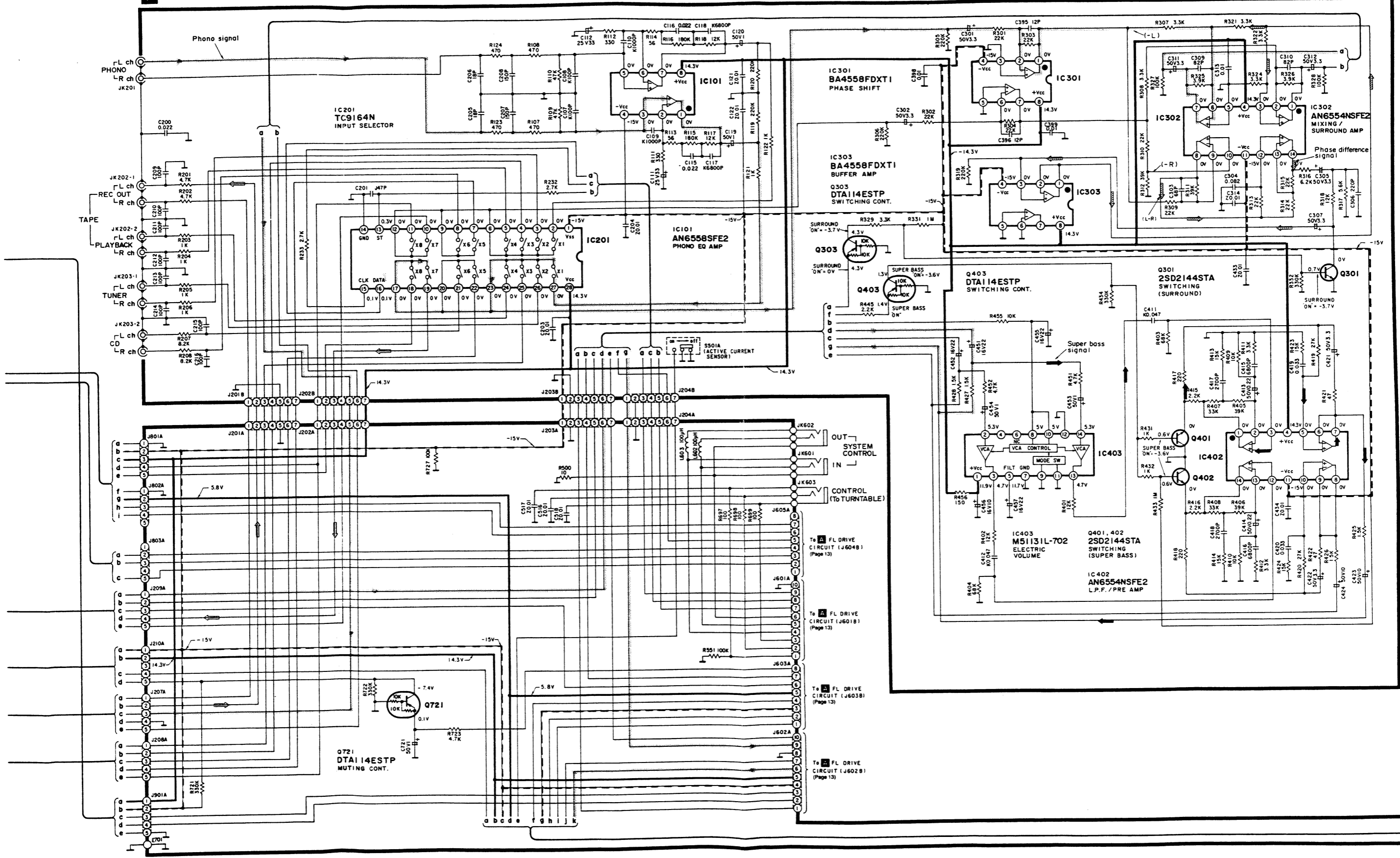

G MAIN CIRCUIT

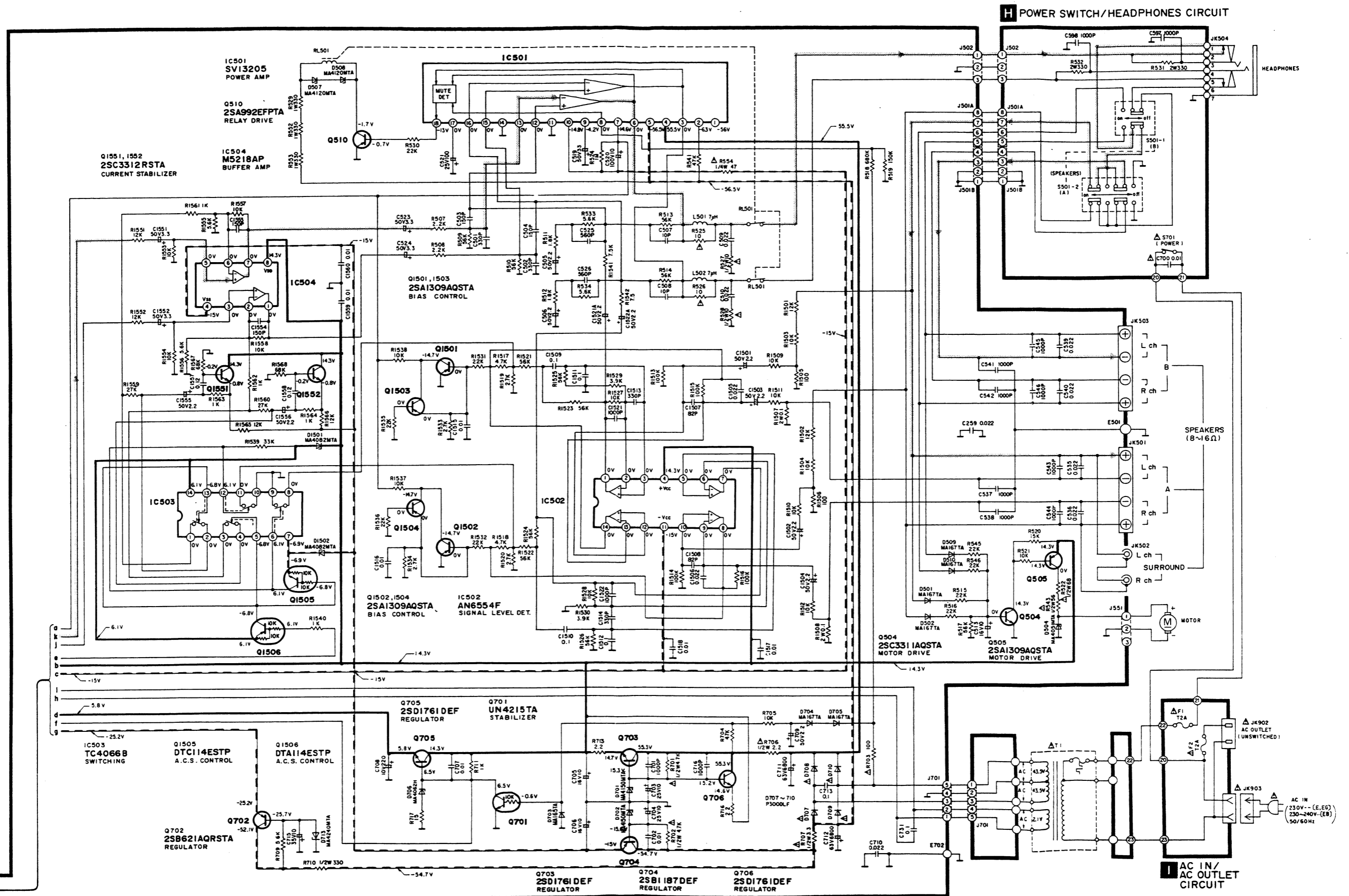

■ CIRCUIT BOARD DIAGRAM

Notes: (This schematic diagram may be modified at any time with the development of new technology.)

- S501A : Active current sensor switch in "OFF" position.
- S501 : Speaker ON/OFF switch.
(S501-1: SPEAKER A in "ON" position)
(S501-2: SPEAKER B in "OFF" position)
- S601 : Turntable input switch. (PHONO)
- S602 : Tuner input switch. (TUNER)
- S603 : Video disc player input switch. (VDP)
- S604 : Tape deck input switch. (TAPE)
- S605 : Video cassette recorder input switch. (VCR)
- S606 : Digital AUX input switch. (DIGITAL AUX)
- S607 : CD input switch. (CD)
- S608 : Digital audio tape deck input switch. (DAT)
- S609 : Super dynamic sound switch. (S. DYNAMIC SOUND)
- S610 : Volume preset switch. (VOLUME PRESET)
- S611 : Super bass switch. (SUPER BASS)
- S612 : Super bass level control switch. (SUPER BASS LEVEL ▲)
- S613 : Super bass level control switch. (SUPER BASS LEVEL ▼)
- S614 : Surround-sound switch. (SURROUND)
- S701 : Power switch. (POWER)

- CD signal (Lch), Phono signal (Lch)
- Positive voltage lines (+)
- - - Negative voltage lines (-)
- Super bass signal
- Phase difference signal
- Recording signal

●Indicated voltage values are the standard values for the unit measured by the DC electronic circuit tester (high-impedance) with the chassis taken as standard. Therefore, there may exist some errors in the voltage values, depending on the internal impedance of the DC circuit tester.

●Important safety notice:
Components identified by ▲ mark have special characteristics important for safety. When replacing any of these components, use only manufacturer's specified parts.

- Caution!
IC and LSI are sensitive to static electricity.
Secondary trouble can be prevented by taking care during repair.
- Cover the parts boxes made of plastics with aluminum foil.
- Ground the soldering iron.
- Put a conductive mat on the work table.
- Do not touch the legs of IC or LSI with the fingers directly.

■ DESCRIPTION OF FL PANEL

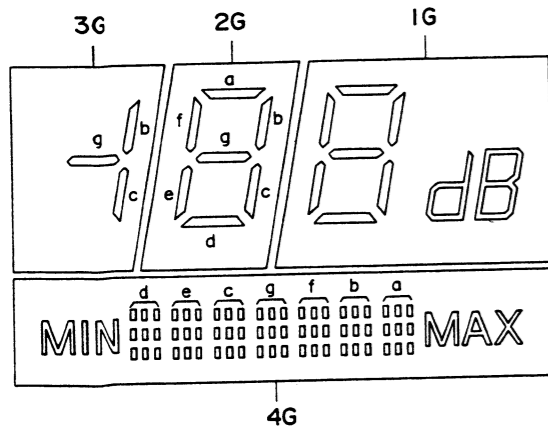

	4G	3G	2G	1G
P1	a	-	a	a
P2	b	b	b	b
P3	c	c	c	c
P4	d	-	d	d
P5	e	-	e	e
P6	f	-	f	f
P7	g	g	g	g
P8	MIN - MAX	-	-	dB

PIN CONNECTION

PIN NO.	1	2	3	4	5	6	7	8	9	10	11	12	13	14	15	16	17	18	19	20	21	22
CONNECTION	F	F	N	4	P	P	3	P	P	2	P	1	P	P	P	N	N	F	F	F	F	F
	2	2	P	G	1	2	G	3	4	G	5	G	6	7	8	P	P	1	1			

- Notes:
F1, F2 Filament
NP No pin
1G~4G Grid

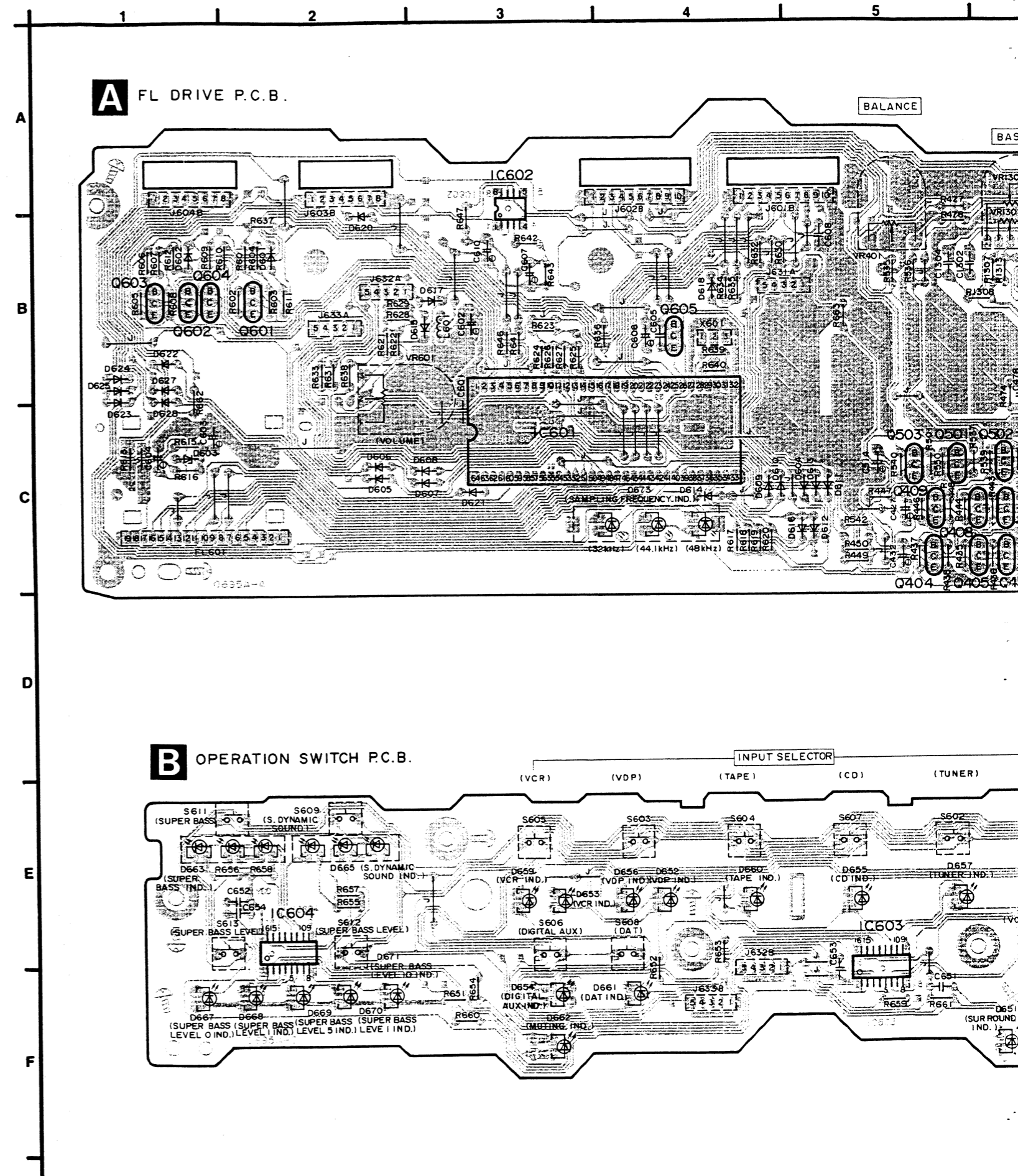

ANCE

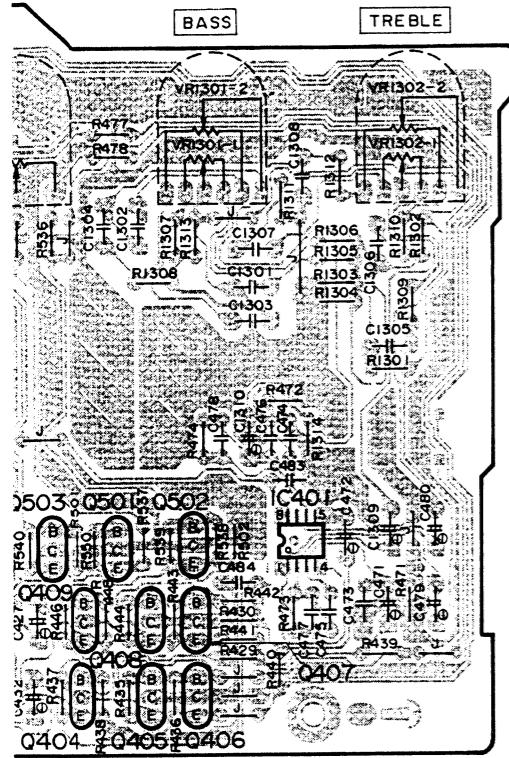

F PHONO/TAPE/TUNER/CD TERMINAL P.C.B.

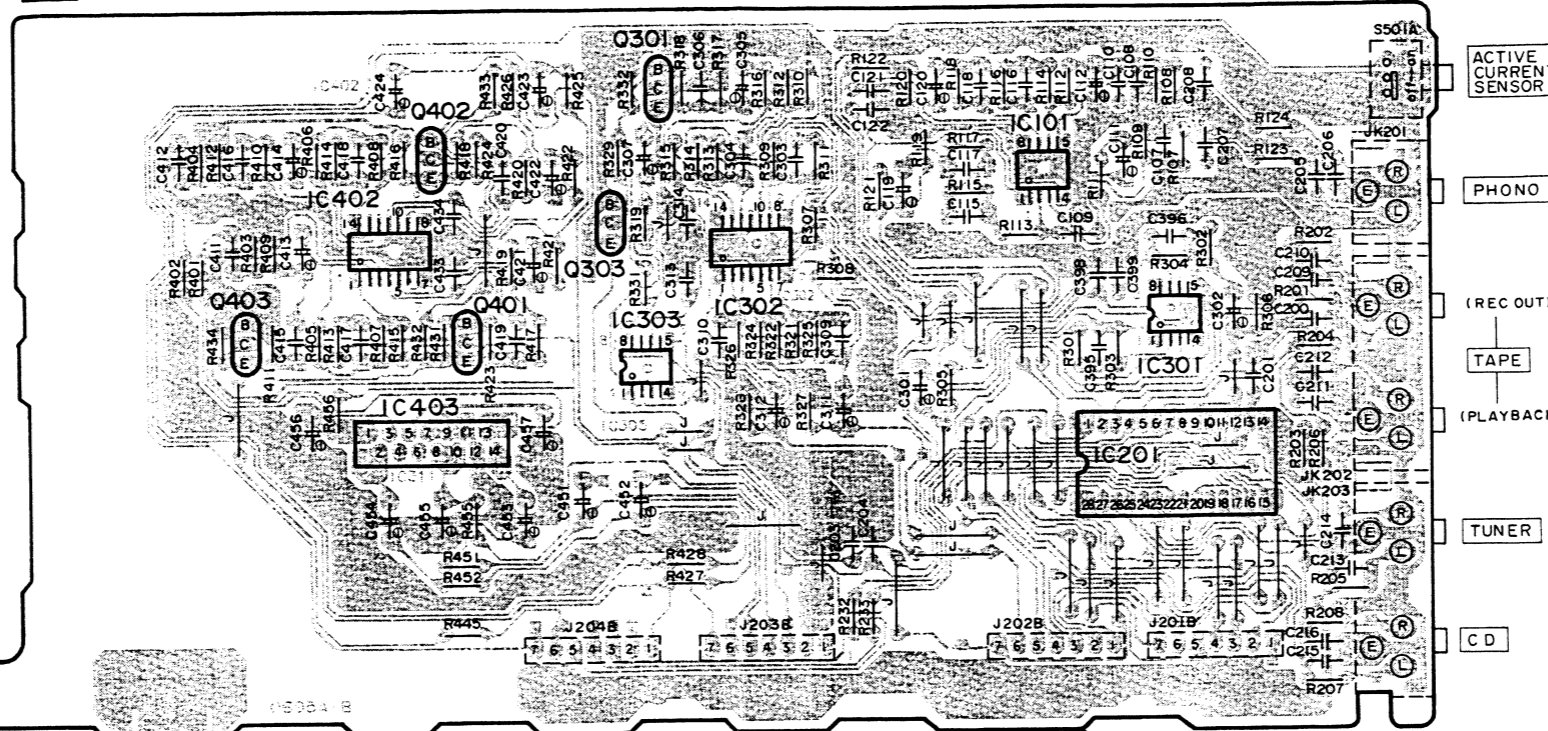

H POWER SWITCH/HEADPHONES P.C.B.

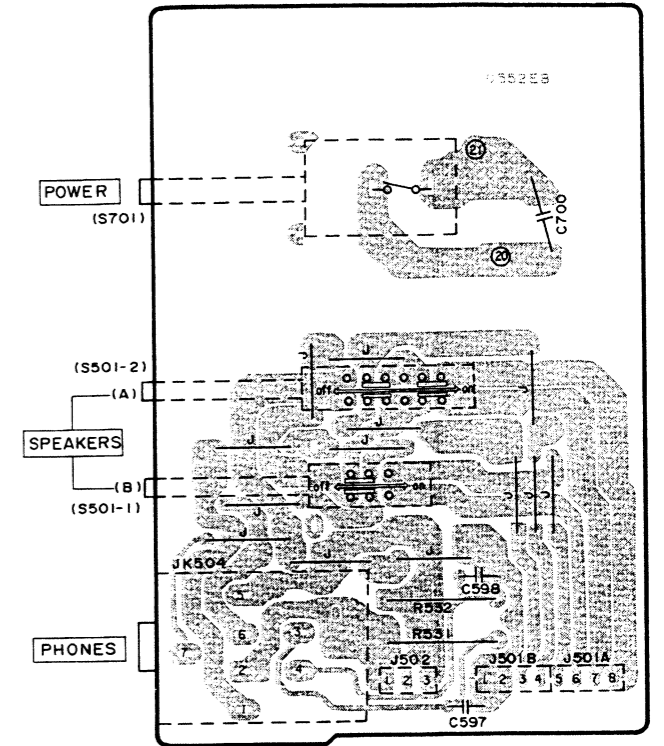

C D/A CONVERTER P.C.B.

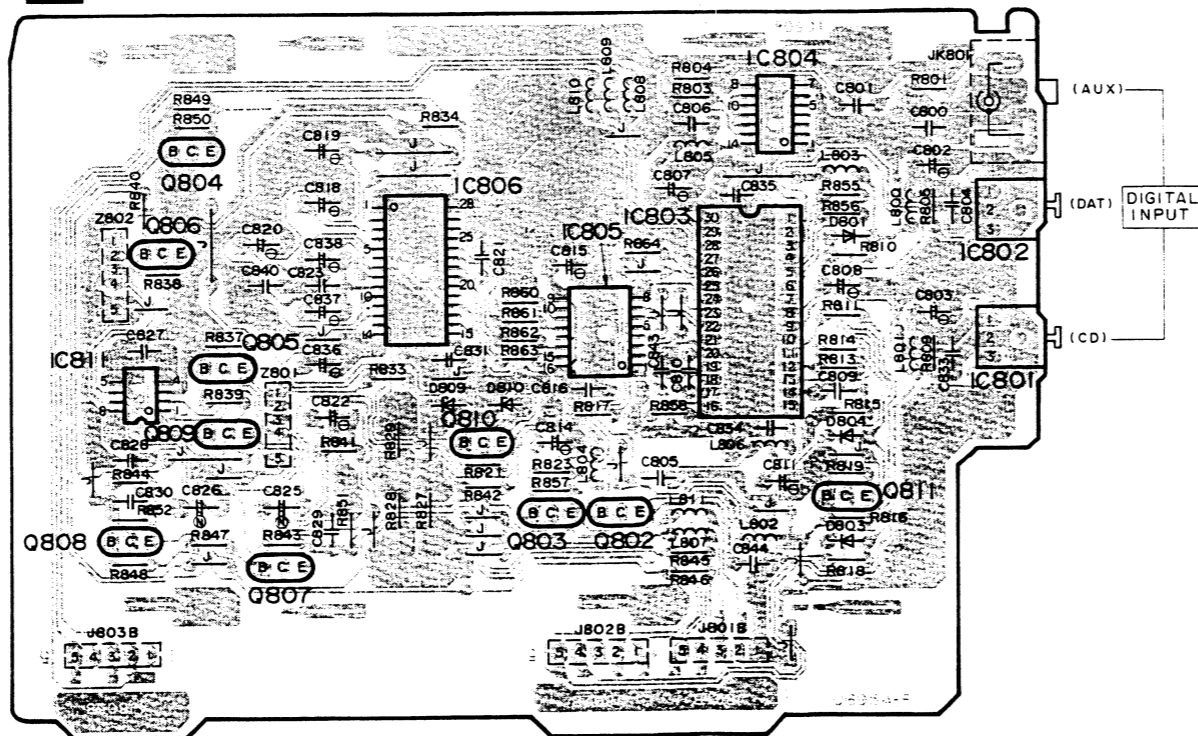

E INPUT/OUTPUT TERMINAL P.C.B.

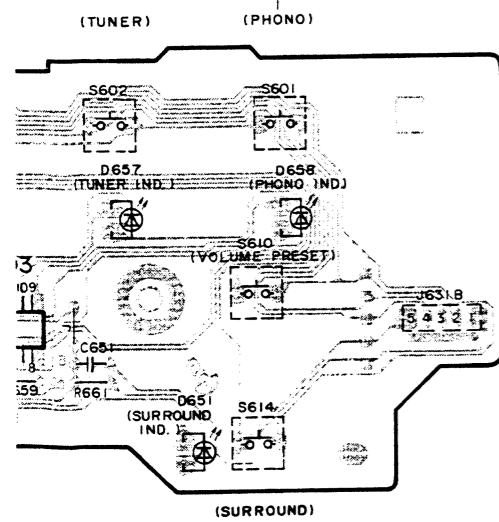
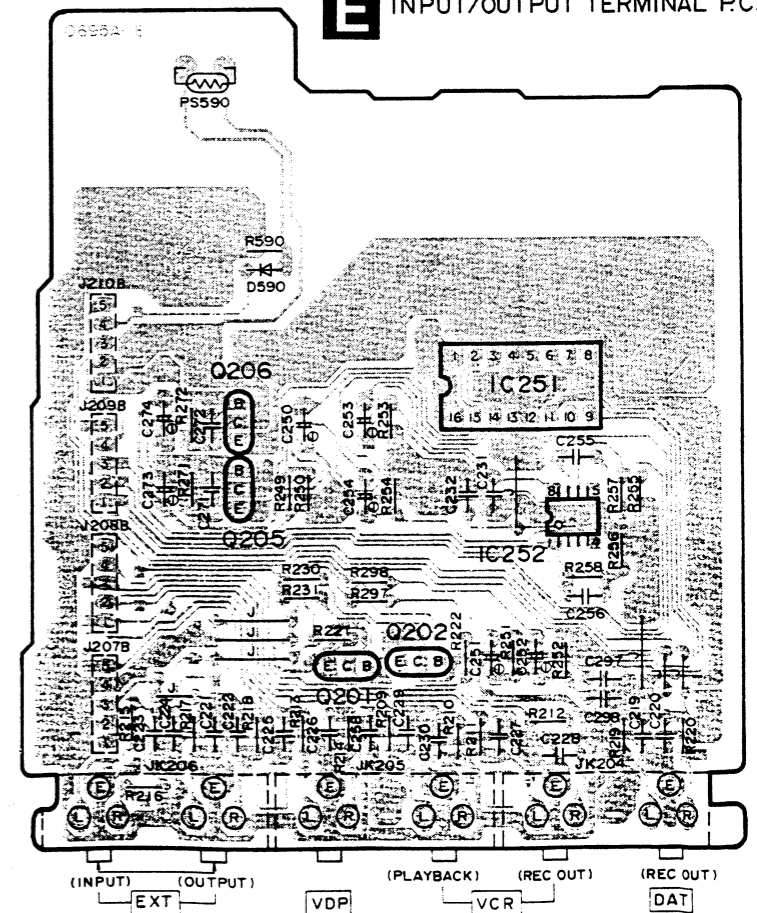

CIRCUIT BOARD DIAGRAM

1 2 3 4 5 6 7 8 9 10

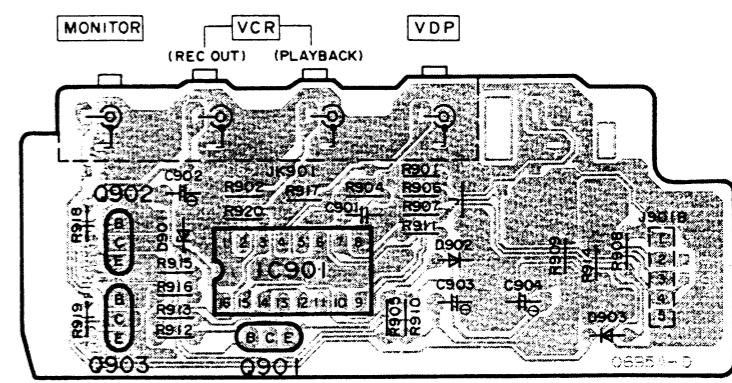
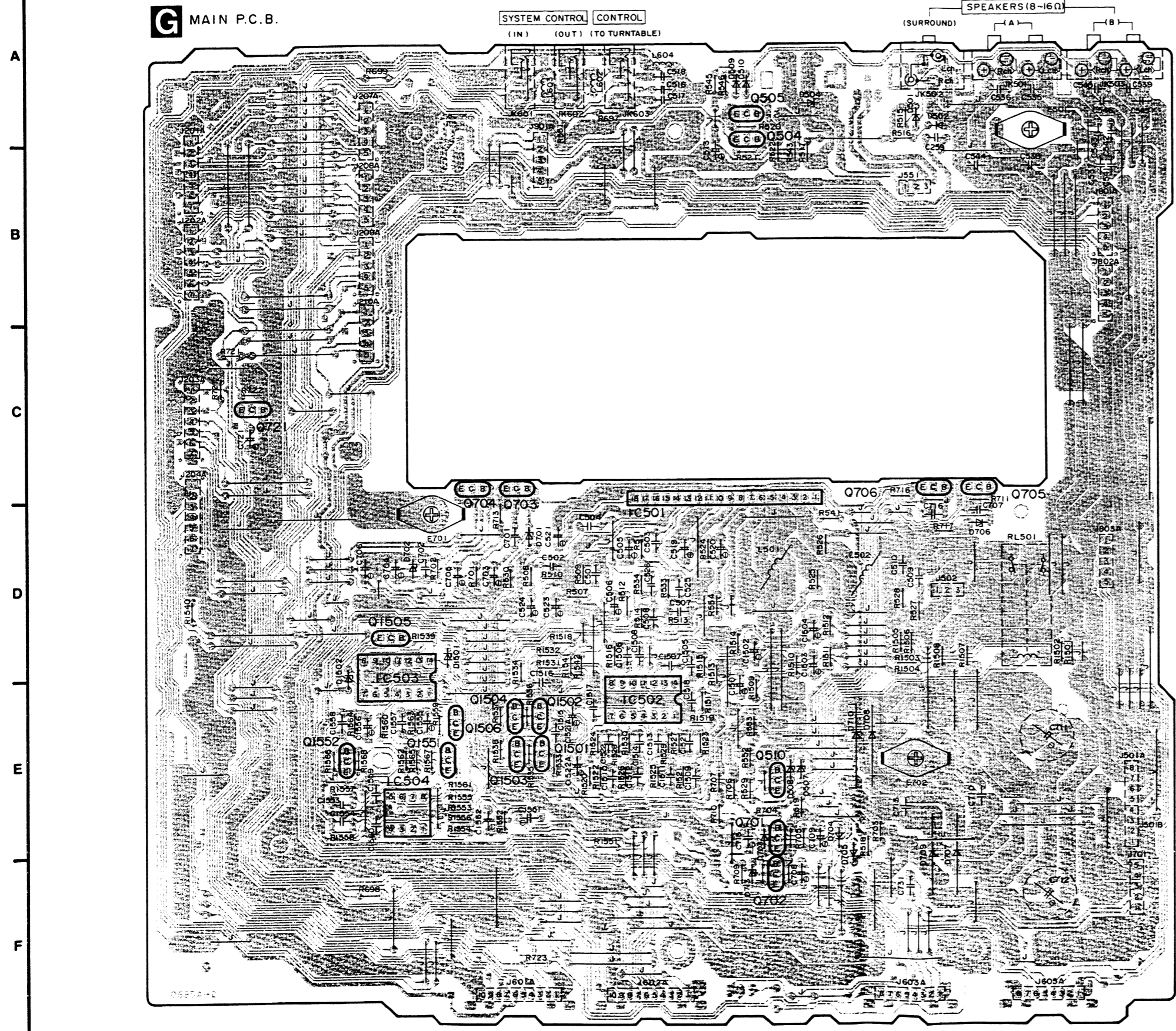

D VIDEO IN/OUT TERMINAL P.C.B.

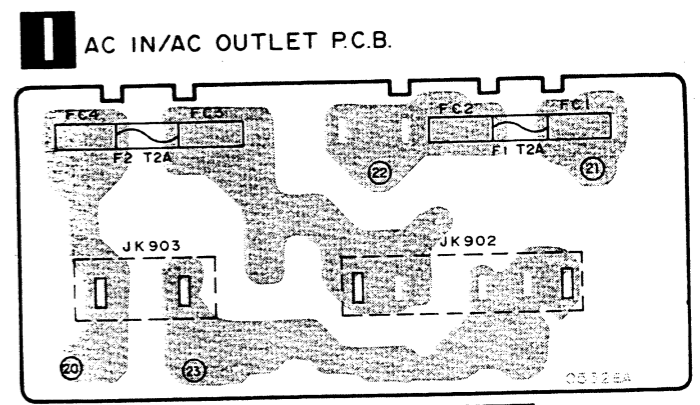

AC IN
230V (E, EG)
230-240V (EB)
50/60Hz

AC OUTLET
(UNSWITCHED)

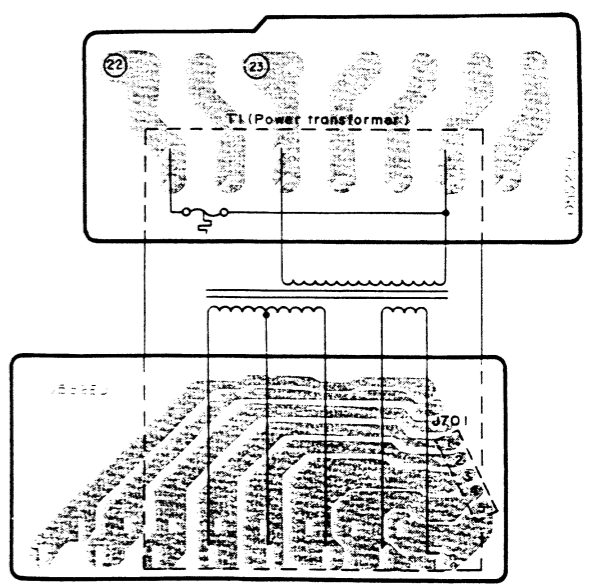



11

12

13

14

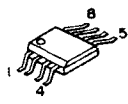
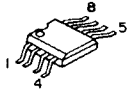
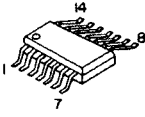
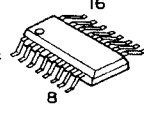
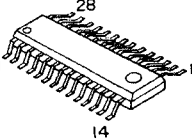
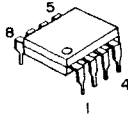
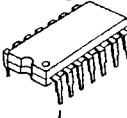
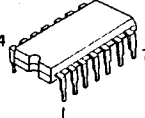
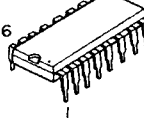
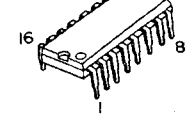
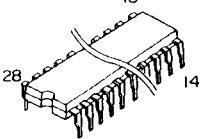
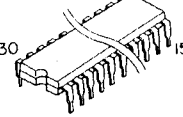
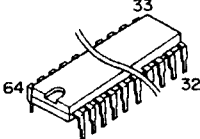
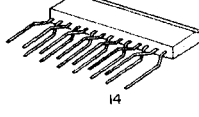
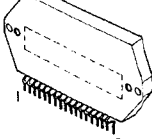
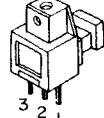
■ TERMINAL GUIDE OF IC'S, TRANSISTORS AND DIODES

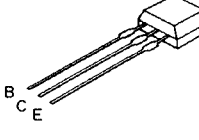
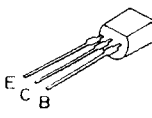
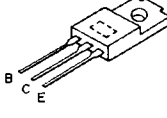
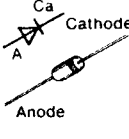
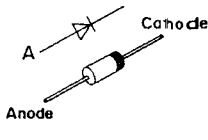
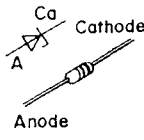
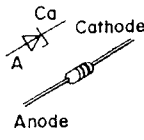
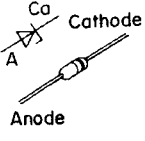
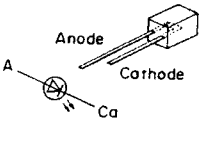
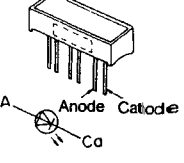
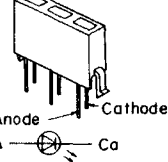
<p>AN6558SFE2</p> 	<p>BA4558FDXT1 BA4560FT1</p> 	<p>AN6554NSFE2</p> 	<p>BU2040F-T2 MC74HCU04FEL</p> 	<p>PCM1700U-T1</p> 
<p>M5218AP</p> 	<p>AN6554F</p> 	<p>TC4066B</p> 	<p>M5283P</p> 	<p>MC14052BCP</p> 
<p>TC9164N</p> 	<p>PD0052</p> 	<p>M50754-180SP</p> 	<p>M51131L-702</p> 	<p>SVI3205</p> 
<p>GP1F32R</p> 	<p>2SA1309AQSTA 2SC3311AQSTA 2SC3312RSTA 2SD1450STTA UN4215TA</p> 	<p>2SD2144STA DTA114ESTP DTC114ESTP DTC144ESTP</p> 		
<p>2SA992EFPTA 2SB621AQRSTA 2SC3114STUTA</p> 	<p>2SB1187DEF 2SD1761DEF</p> 	<p>MA165TA MA167TA MA700TA 1SS291TA</p> 	<p>P300DLF</p> 	<p>MA4043MTA MA4047MTA MA4051LTA MA4051MTA</p> 
<p>MA4043MTA MA4047MTA MA4051LTA MA4051MTA</p> 	<p>MA4120MTA MA4150MTA</p> 	<p>LN473YP-C LN873RP-C</p> 	<p>LD701YY</p> 	<p>LN038568PH</p> 

WIRING CONNECTION DIAGRAM

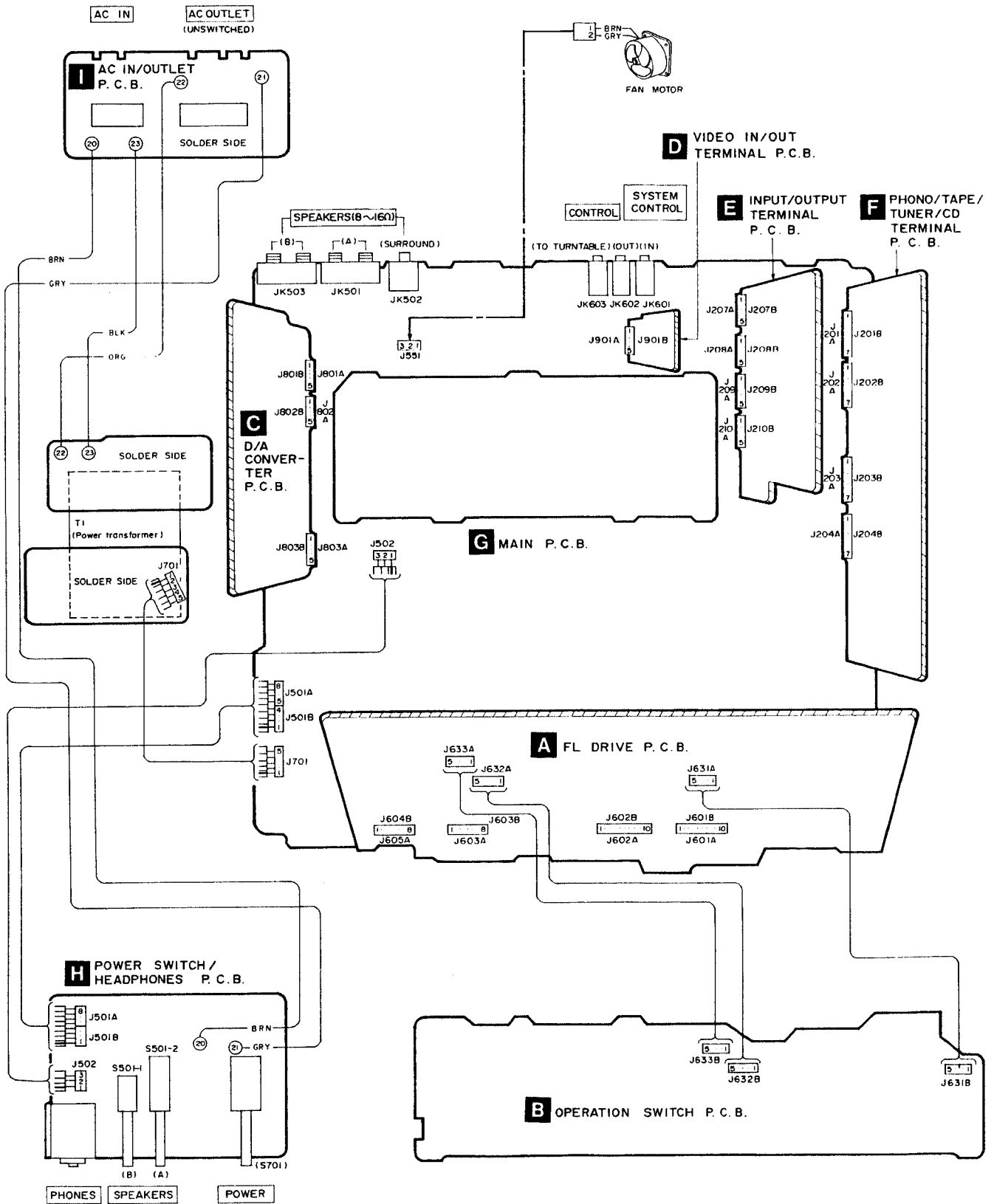

FUNCTION OF IC TERMINALS

●IC601

Pin No.	Symbol	I/O	Function Description
1	VDD	I	+5 V
2	B. DATA OUT	O	Bus data signal out
3	B. CLK OUT	O	Bus clock signal out
5	S. BASS PWM	O	Super bass control signal output
6	VR PWM	O	Volume control signal output
7	B. DATA IN	I	Bus data signal input
8	B. CLK IN	I	Bus clock signal input
9	VRA	I	Rotary encoder (VR601) signal input (Volume control)
10	VRB		
11 }	MUT3	O	Muting control signal output
13	MUT1		
15	RECM	O	Muting control signal output for VTR recording
16	DATA	O	Data signal output
17	CLK	O	Clock signal output
18	STB1	O	The serial data inputted in to IC201 is latched by the STB pulse and the switch is set to ON according to data
19	DATA2	O	LED control signal output
20	CLK2	O	Clock output for IC604
21	PLSTOP	O	Player control signal output
22	PLST/ PHONO		
23	PSAY		
24	HLT/HST	I	Power supply detect signal input

Pin No.	Symbol	I/O	Function Description
25	DIR1	I	Sampling frequency detect signal input
26	CNVSS	—	GND
27	RESET	I	Reset signal input
28	X IN	I	Clock signal input
29	X OUT	O	Clock signal output
32	VSS	—	GND
34 }	KS3	I	Key scan signal input
37	KS0		
38	VP	I	Pull down voltage detect signal input
39	S2	O	Input select control signal output
40	S1		
41 }	S8	O	FL drive signal output
48	S1		
49 }	K4		
52	K1		
53 }	G4	O	LED control signal output
56	G1		
57	SEL2	O	LED control signal output
58	SEL1	O	LED control signal output
60	S. BASS. D	O	Super bass control signal output
63	SURR. D	O	Surround control signal output

●IC805

Pin No.	Symbol	I/O	Function Description
1	X IN	I	Clock signal input
2	X OUT	O	Clock signal output
3	MODE1	I	Master clock input
4	CK OUT	—	NC
5	LR CLK	I	LR clock input
6	DATA	I	Serial data input
7	BCK	I	Bit clock input
8	VSS	—	GND

Pin No.	Symbol	I/O	Function Description												
9	MODE2	I	Select the output data <table border="1"> <thead> <tr> <th>MODE3</th> <th>MODE2</th> <th>OUTPUT DATA</th> </tr> </thead> <tbody> <tr> <td>H</td> <td>H</td> <td>18 bit</td> </tr> <tr> <td></td> <td>L</td> <td>16 bit</td> </tr> <tr> <td>L</td> <td>—</td> <td>20 bit</td> </tr> </tbody> </table>	MODE3	MODE2	OUTPUT DATA	H	H	18 bit		L	16 bit	L	—	20 bit
MODE3	MODE2			OUTPUT DATA											
H	H			18 bit											
	L	16 bit													
L	—	20 bit													
13	MODE3														
10	SHOUT	—	NC												
11	LD OUT	O	Lch signal output												
12	RD OUT	O	Rch signal output												
14	W OUT	O	Ward clock output												
15	B OUT	O	Bit clock output												
16	VDD	I	To be connected to a power supply (+5 V)												

●IC803

Pin No.	Symbol	I/O	Function Description
1	IN1	I	Digital audio interface signal input
2	IN2		
3	IN3		
4	S1	I	Input select 1
5	S2	I	Input select 2
6	OUT	O	Input data select signal out
7	TEST	I	———— (VDD)
8	RESET	I	Reset signal input
9	VCOINH	I	VCO control signal input
10	VSS	—	Digital ground
11	PCVS	I	VCO control signal input
12	PCOUT	O	Phase comparative output
13	R	—	VCO adjustment (Resistor)
14	VCO IN	I	VCO control signal input
15	VDD1	I	VCO VDD

Pin No.	Symbol	I/O	Function Description
16	VCO OUT	O	VCO output
17	VSS1	—	VCO ground
18	CA	—	VCO adjustment (Capacitor)
19	CB	—	VCO adjustment (Capacitor)
20	MODE	—	L: 16 bit H: 20 bit
21	BCK	O	Data bit clock output
22	DATA	O	Audio data output
23	LRCK	O	Lch/Rch data output (H: Lch)
24	COPY	—	————
25	EMPH	O	Emphasis data output
26	ERR	O	PLL data error output (H: error)
27	48K	O	Sampling frequency data output LED drive signal output
28	44.1K		
29	32K		
30	VDD	I	Digital VDD

●IC806

Pin No.	Symbol	I/O	Function Description
1	A. GND	—	Analog ground
2	I OUT (R)	O	Current output (Rch)
3	BPO DC (R)	I	Offset filter (Rch)
4	MSB ADJ (R)	—	————
5	SERVO DC (R)	I	Servo filter (Rch)
6	V POT	—	————
7	VCC	I	Analog positive supply
8	D. GND	—	Digital ground
9	-VCC	I	Analog negative supply
10	SERVO DC (L)	I	Servo filter (Lch)
11	MSB ADJ (L)	—	————
12	BPO DC (L)	I	Offset filter (Lch)
13	I OUT (L)	O	Current output (Lch)
14	A. GND	—	Analog ground

Pin No.	Symbol	I/O	Function Description
15	S. J (L)	I	Summing junction (Lch)
16	V OUT (L)	O	Voltage output (Lch)
17	NC	—	————
18	VDD	I	Digital positive supply
19	NC	—	————
20	DATA (L)	I	Data input (Lch)
21	CLOCK	I	Clock input
22	-VDD	I	Digital negative supply
23	LEC	I	Latch enable control input
24	DATA (R)	I	Data input (Rch)
25	D. GND	—	Digital ground
26	NC	—	————
27	V OUT (R)	O	Voltage output (Rch)
28	S. J (R)	I	Summing junction (Rch)

BLOCK DIAGRAM

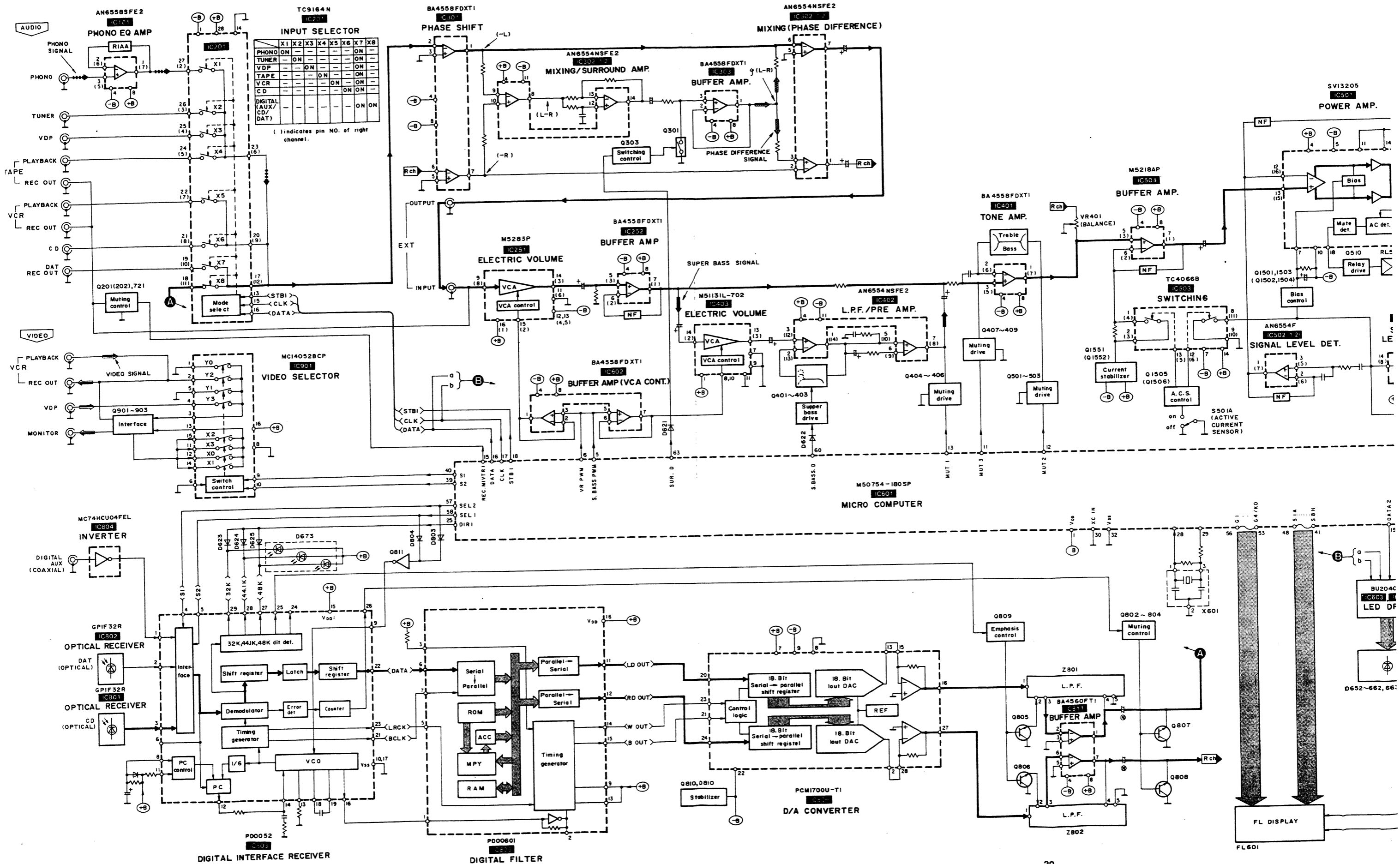

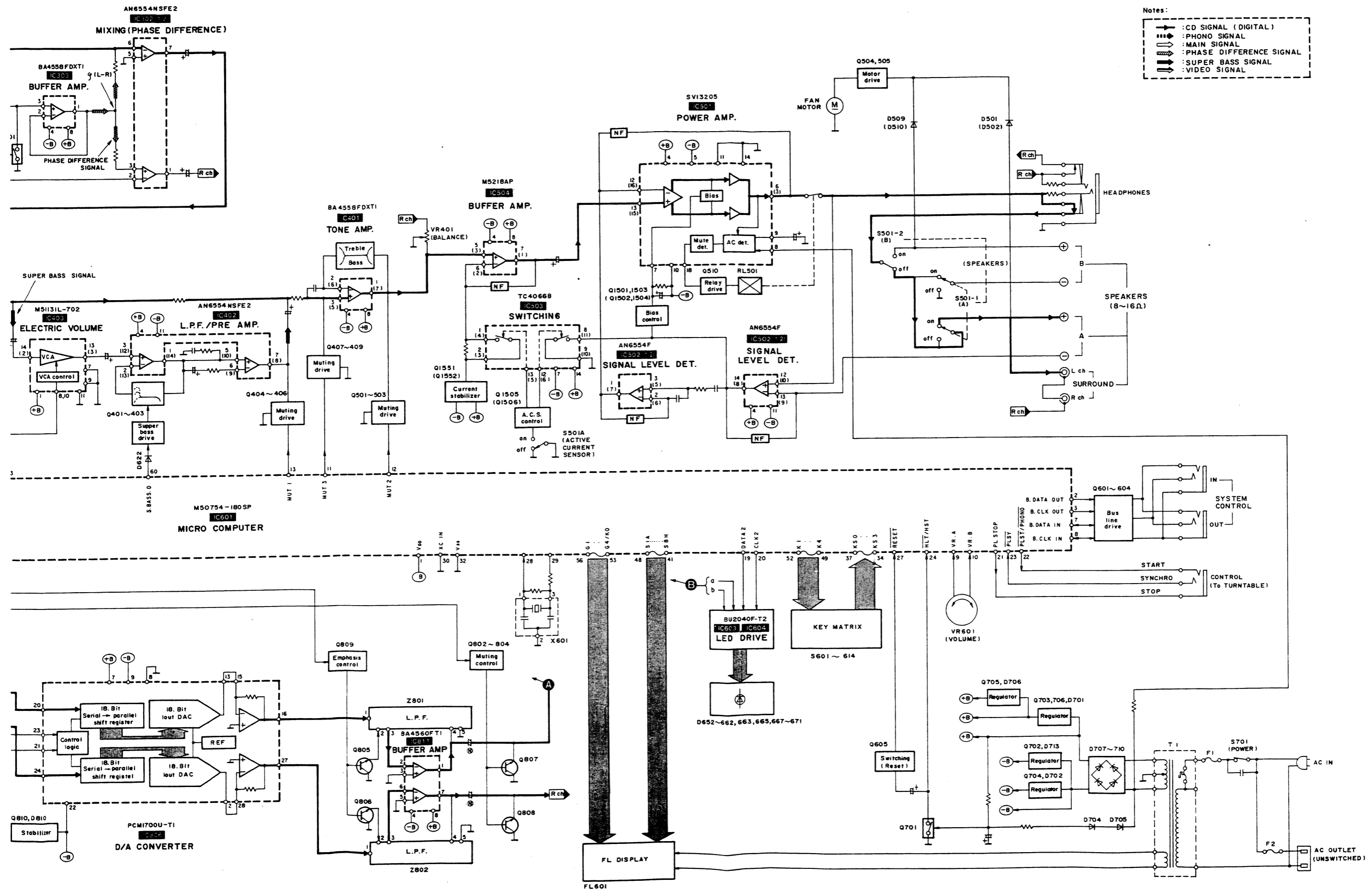
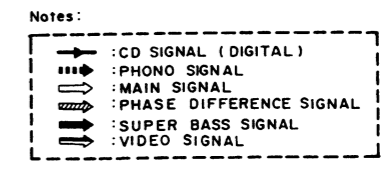

REPLACEMENT PARTS LIST

Notes : - Important safety notice:
 Components identified by Δ mark have special characteristics important for safety. When replacing any of these components use only manufacturer's specified parts.
 • The parenthesized indications in the Remarks columns specify the areas. (Refer to the cover page for area.)
 Parts without these indications can be used for all areas.

Ref. No.	Part No.	Part Name & Description	Remarks	Ref. No.	Part No.	Part Name & Description	Remarks
		INTEGRATED CIRCUIT(S)					
IC101	AN6558SFE2	I. C. PHONO EQ AMP		Q603	2SC3311A-Q	TRANSISTOR	
IC201	TC9164M	I. C. INPUT SELECTOR		Q604	DTC144EXT96	TRANSISTOR	
IC251	M6283P	I. C. ATTENUATOR		Q605	DTC114ESTP	TRANSISTOR	
IC252	BA4558FDKTI	I. C. BUFFER AMP		Q701	UN4215	TRANSISTOR	
IC301	BA4558FDKTI	I. C. PHASE SHIFT		Q702	2SB621A-R	TRANSISTOR	
IC302	AN6554NSFEZ	I. C. MIXING/SURROUND AMP		Q703	2SD1761DEF	TRANSISTOR	
IC303	BA4558FDKTI	I. C. BUFFER AMP		Q704	2SB1187DEF	TRANSISTOR	
IC401	BA4558FDKTI	I. C. TONE AMP		Q705, 706	2SD1761DEF	TRANSISTOR	
IC402	AN6554NSFEZ	I. C. L. P. F. /PRE AMP		Q721	DTA114ESTP	TRANSISTOR	
IC403	M51131L-702	I. C. ELECTRIC VOLUME		Q802, 803	DTC114ESTP	TRANSISTOR	
IC501	SV13205	I. C. POWER AMP		Q804	DTA114ESTP	TRANSISTOR	
IC502	AN6554F	I. C. SIGNAL LEVEL DET.		Q805, 806	2SC3114STUTA	TRANSISTOR	
IC503	TC4066B	I. C. SWITCHING		Q807, 808	2SD2144S	TRANSISTOR	
IC504	M5218AP	I. C. BUFFER AMP		Q809	DTA114ESTP	TRANSISTOR	
IC601	M50754-180SP	I. C. MICRO COMPUTER		Q810	2SC3311A-Q	TRANSISTOR	
IC602	BA4558FDKTI	I. C. BUFFER AMP		Q811	DTC114ESTP	TRANSISTOR	
IC603, 604	BU2040F-T2	I. C. LED DRIVE		Q901	2SA1309A-R	TRANSISTOR	
IC801, 802	GP1F32R	I. C. OPTICAL RECEIVER		Q902, 903	2SC3311A-Q	TRANSISTOR	
IC803	PD0052	I. C. DIGITAL INTERFACE		Q1501-1504	2SA1309A-R	TRANSISTOR	
IC804	MC74HC04FEL	I. C. INVERTER		Q1505	DTC114ESTP	TRANSISTOR	
IC805	PD00601	I. C. DIGITAL FILTER		Q1506	DTA114ESTP	TRANSISTOR	
IC806	PCML700U-T1	I. C. D/A CONVERTER		Q1551, 1552	2SC3312RSTA	TRANSISTOR	
IC811	SV1BA4560FT1	I. C. BUFFER AMP				DIODE (S)	
IC901	MC14052BCP	I. C. VIDEO SELECTOR		D501, 502	MA167	DIODE	
		TRANSISTOR(S)		D504	MA405LMTA	DIODE	
Q201, 202	2SD2144S	TRANSISTOR		D507, 508	MA4120	DIODE	
Q205	2SC3311A-Q	TRANSISTOR		D509, 510	MA167	DIODE	
Q206	2SA1309A-R	TRANSISTOR		D580	MA165	DIODE	
Q301	2SD2144S	TRANSISTOR		D601, 602	MA700	DIODE	
Q303	DTA114ESTP	TRANSISTOR		D603	MA4047MTA	DIODE	
Q401, 402	2SD2144S	TRANSISTOR		D604-614	MA165	DIODE	
Q403	DTA114ESTP	TRANSISTOR		D615	1SS291TA	DIODE	
Q404	DTA114ESTP	TRANSISTOR		D616-618	MA165	DIODE	
Q405-408	2SD2144S	TRANSISTOR		D620-625	MA165	DIODE	
Q409	2SA1309A-R	TRANSISTOR		D627, 628	MA165	DIODE	
Q501, 502	2SD1450STTA	TRANSISTOR		D651	LN873RP-C	DIODE	
Q503	2SA1309A-R	TRANSISTOR		D652, 653	LN473YP-C	DIODE	
Q504	2SC3311A-Q	TRANSISTOR		D654-662	LN873RP-C	DIODE	
Q505	2SA1309A-R	TRANSISTOR		D663	LD701YY	DIODE	
Q510	2SA992EPPTA	TRANSISTOR		D665	LD701YY	DIODE	
Q601	2SC3311A-Q	TRANSISTOR		D667-671	LN873RP-C	DIODE	
Q602	DTC144EXT96	TRANSISTOR		D673	LN03B568PH	DIODE	
				D701, 702	MA4150M	DIODE	
				D703	MA165	DIODE	
				D704, 705	MA167	DIODE	

Ref. No.	Part No.	Part Name & Description	Remarks	Ref. No.	Part No.	Part Name & Description	Remarks
D706	MA4062-H	DIODE				FUSE (S)	
D707-710 Δ	P300DLF	DIODE					
D713	MA4240H	DIODE					
D801	MA165	DIODE		F1, 2 Δ	XBA2C20TBO	FUSE	
D803, 804	MA165	DIODE				SWITCH (ES)	
D809	MA4051-L	DIODE					
D810	MA4043M	DIODE		SS01A	RSS2B006-M	SW, ACTIVE CURRENT SENSOR	
D901	MA4047MTA	DIODE		SS01	SSH212B	SW, SPEAKER ON/OFF	
D902, 903	MA165	DIODE		S601	EVQ21405R	SW, PHONO	
D1501, 1502	MA4082MTA	DIODE		S602	EVQ21405R	SW, TUNER	
		VARIABLE RESISTOR(S)		S603	EVQ21405R	SW, VDP	
				S604	EVQ21405R	SW, TAPE	
VR401	EWFDAF20G15	V. R. BALANCE		S605	EVQ21405R	SW, VCR	
VR601	EVQWAF2524B	V. R. VOLUME		S606	EVQ21405R	SW, DIGITAL MIX	
VR1301	EW2XAF20C15	V. R. BASS		S607	EVQ21405R	SW, CD	
VR1302	EW2XAF20C15	V. R. TREBLE		S608	EVQ21405R	SW, DAT	
		POSISTOR(S)		S609	EVQ21405R	SW, S. DYNAMIC SOUND	
				S610	EVQ21405R	SW, VOLUME PRESET	
PS590	SRPBD47101	POSISTOR		S611	EVQ21405R	SW, SUPER BASS	
		COMPONENT COMBINATION(S)		S612	EVQ21405R	SW, SUPER BASS LEVEL UP	
				S613	EVQ21405R	SW, SUPER BASS LEVEL DOWN	
Z801, 802	HBDN2041B	COMPONENT COMBINATION		S614	EVQ21405R	SW, SURROUND	
				S701 Δ	ES88249V	SW, POWER	
		COIL (S)				CONNECTOR	
L501, 502	SLQY07G-40	COIL		J502	RJS1A1703	CONNECTOR (3P)	
L601	ELEXT100KA9	COIL		J551	SJT3213	CONNECTOR (3P)	
L602, 603	RLQZP101KT-Y	COIL		J701	RJS1A1705	CONNECTOR (5P)	
L800, 801	RLQZP470KT-Y	COIL		J201A	RJU060G07T	SOCKET	
L802	RLQZP101KT-Y	COIL		J202A	RJU060G07T	SOCKET	
L803	RLQZP3R3KT-Y	COIL		J203A	RJU060G07T	SOCKET	
L804	RLQZP1R2KT-Y	COIL		J204A	RJU060G07T	SOCKET	
L805	RLQZP3R3KT-Y	COIL		J207A	RJU060G05T	SOCKET	
L806	RLQZP1R2KT-Y	COIL		J208A	RJU060G05T	SOCKET	
L807	RLQZP3R3KT-Y	COIL		J209A	RJU060G05T	SOCKET	
L808-810	RLQZP1R2KT-Y	COIL		J210A	RJU060G05T	SOCKET	
L811	RLQZP3R3KT-Y	COIL		J501A	RJS1A1704	CONNECTOR (4P)	
		TRANSFORMER (S)		J601A	RJU003K010M1	SOCKET (10P)	
				J602A	RJU003K010M1	SOCKET (10P)	
				J603A	RJU003K009M1	SOCKET (8P)	
T1 Δ	RTP1P5E004-W	POWER TRANSFORMER	(E, EG)	J605A	RJU003K008M1	SOCKET (8P)	
T1 Δ	SLT5P288-W	POWER TRANSFORMER	(EB)	J631A	SJT305498B1	CONNECTOR	
		OSCILLATOR(S)		J632A	SJT305498B1	CONNECTOR	
				J633A	SJT305498B1	CONNECTOR	
				J801A	RJU060G05T	SOCKET	
X601	EP0GC6004T4	CERAMIC FILTER		J802A	RJU060G05T	SOCKET	
		DISPLAY TUBE		J803A	RJU060G05T	SOCKET	
				J901A	RJU060G05T	SOCKET	
				J201B	RJT060B07	CONNECTOR	
FL601	RSLD074-F	DISPLAY TUBE		J202B	RJT060B07	CONNECTOR	

Ref. No.	Part No.	Part Name & Description	Remarks				
J203B	RJT060B07	CONNECTOR					
J204B	RJT060B07	CONNECTOR					
J207B	RJT060B05	CONNECTOR					
J208B	RJT060B05	CONNECTOR					
J209B	RJT060B05	CONNECTOR					
J210B	RJT060B05	CONNECTOR					
J501B	RJS1A1704	SOCKET (4P)					
J601B	RJT003K010M1	CONNECTOR (10P)					
J602B	RJT003K010M1	CONNECTOR (10P)					
J603B	RJT003K008M1	CONNECTOR (8P)					
J604B	RJT003K008M1	CONNECTOR (8P)					
J631B	SJS0581BB	SOCKET (5P)					
J632B	SJS0581BB	SOCKET (5P)					
J633B	SJS0581BB	SOCKET (5P)					
J801B	RJT060B05	CONNECTOR					
J802B	RJT060B05	CONNECTOR					
J803B	RJT060B05	CONNECTOR					
J901B	RJT060B05	CONNECTOR					
		JACK (S)					
JK201	SJF3068N	TERMINAL, PHONO					
JK202	SJF3069-5N	TERMINAL, TAPE					
JK203	SJF3069N	TERMINAL, TUNER/CD					
JK204	SJF3069N	TERMINAL, DAT/VCR					
JK205	SJF3069-5N	TERMINAL, VCR/VDP					
JK206	SJF3069N	TERMINAL, EXT					
JK501	RJR0054M	TERMINAL, SPEAKER A					
JK502	SJF3068-6N	TERMINAL, SPEAKER SURROUND					
JK503	RJR0054M	TERMINAL, SPEAKER B					
JK504	SJ145A-1	JACK, HEADPHONES					
JK601	RJJ33T01	SYNCHRO, SYSTEMCONT. IN					
JK602	RJJ33T01	SYNCHRO, SYSTEMCONT. OUT					
JK603	RJJ33T01	SYNCHRO, CONTROL TO TURNTABL					
JK801	SJFD7-2	TERMINAL, DIGITAL INPUT					
JK901	SJF3061N	MONITOR, VCR/VDP					
JK902 Δ	SJS9333B	AC OUTLET	(E, EG)				
JK902 Δ	SJS9332B	AC OUTLET	(EB)				
JK903 Δ	SJS9231-1B	AC INLET					
		FUSE HOLDER (S)					
FC1-4 Δ	SJT388	FUSE HOLDER					
		RELAY (S)					
RL501	SSY134	RELAY					

Ref. No.	Part No.	Values & Remarks	Ref. No.	Part No.	Values & Remarks	Ref. No.	Part No.	Values & Remarks
C457	ECEAIKKA220B	16V 22U	C802, 803	ECEAIKKA100B	16V 10U			
C471, 472	ECAIHAP3R3B	50V 3. 3U	C804	ECBTIH1042F5	50V 0. 1U			
C473, 474	ECBTIH101KBS	50V 100P	C805	ECBTIH102KBS	50V 1000P			
C475, 476	ECBTIH821KBS	50V 820P	C806	ECFR1E1042F5	25V 0. 1U			
C477, 478	ECBTIH680J5	50V 68P	C807	ECEAIKKA100B	16V 10U			
C479, 480	ECEAIHKA3R3B	50V 3. 3U	C808	ECEAIHKA010B	50V 1U			
C483, 484	ECBT1E103ZF	25V 0. 01U	C809	ECQV1H104JZ3	50V 0. 1U			
C501, 502	ECBTIH331KBS	50V 330P	C810	ECBTIH220J5	50V 22P			
C503, 504	ECBTIH151KBS	50V 150P	C811	ECEADJKA101B	6. 3V 100U			
C505, 506	ECAIHAP2R2B	50V 2. 2U	C814	ECEADJKA101B	6. 3V 100U			
C507, 508	ECBTIH100J5	50V 10P	C815	ECEAIKKA100B	16V 10U			
C509, 510	ECBTIH223ZF	50V 0. 022U	C816	ECBTIH102KBS	50V 1000P			
C513	ECEAIKKA100B	16V 10U	C818	ECEALEKA4R7B	25V 4. 7U			
C514	ECEADJKA470B	6. 3V 47U	C819, 820	ECEADJKA101B	6. 3V 100U			
C516-518	ECBT1E103ZF	25V 0. 01U	C821	ECBT1E103ZF	25V 0. 01U			
C519	ECAIHAP330B	50V 33U	C822	ECEALEKA100B	25V 10U			
C520	ECAZAAP100B	100V 10U	C823	ECBTIH102KBS	50V 1000P			
C521	ECAIEM101B	25V 100U	C825, 826	ECEALCN100B	16V 10U			
C523, 524	ECAIHAP3R3B	50V 3. 3U	C827, 828	ECBTIC103MS	16V 0. 01U			
C525, 526	ECBTIH561KBS	50V 560P	C829, 830	ECBTIH102KBS	50V 1000P			
C535, 536	ECBT1E223ZF	25V 0. 022U	C831	ECBT1E103ZF	25V 0. 01U			
C537, 538	ECBTIH102KBS	50V 1000P	C833	ECBTIH1042F5	50V 0. 1U			
C539, 540	ECBT1E223ZF	25V 0. 022U	C834	ECBTIH102KBS	50V 1000P			
C541-546	ECBTIH102KBS	50V 1000P	C835	ECBT1E103ZF	25V 0. 01U			
C597, 598	ECBTIH102KBS	50V 1000P	C836-838	ECEALEKA4R7B	25V 4. 7U			
C601	ECBT1E103ZF	25V 0. 01U	C840	ECBTIH331KBS	50V 330P			
C602	ECEADJ102	6. 3V 1000U	C843	ECBTIH220J5	50V 22P			
C603	ECEAIHKA3R3B	50V 3. 3U	C844	ECBTIH102KBS	50V 1000P			
C604	ECEAIKKA100B	35V 10U	C901	ECBT1E103ZF	25V 0. 01U			
C605	ECBT1E103ZF	25V 0. 01U	C902	ECEAIKKA100B	16V 10U			
C606, 607	ECEAIHKA010B	50V 1U	C903, 904	ECEAIKKA470B	16V 47U			
C608	ECBTIH101KBS	50V 100P	C1301, 1302	ECFR1E123KR	25V 0. 012U			
C610	ECEAIHKA010B	50V 1U	C1303, 1304	ECFR1E583KR	25V 0. 068U			
C651, 652	ECBTIH1042F5	50V 0. 1U	C1305, 1306	ECFR1E472KR	25V 4700P			
C653, 654	ECBTIH470J5	50V 47P	C1307, 1308	ECFR1E223KR	25V 0. 022U			
C700	ECMMS103ZV	500V 0. 01U	C1309, 1310	ECAIHAP010B	50V 1U			
C701	ECBTIH102KBS	50V 1000P	C1501-1504	ECEAIHKA2R2B	50V 2. 2U			
C702	ECRRIH103ZF5	50V 0. 01U	C1505, 1506	ECFR1E223KR	25V 0. 022U			
C703, 704	ECEALEKA100B	25V 10U	C1507, 1508	ECBTIH20KBS	50V 82P			
C705, 706	ECEAIKKA100B	16V 10U	C1509-1512	ECFR1E104KR	25V 0. 1U			
C707	ECBT1E103ZF	25V 0. 01U	C1513, 1514	ECBTIH331KBS	50V 330P			
C708	ECEAIAR221	10V 220U	C1515, 1516	ECBTIC103MS	16V 0. 01U			
C709	ECEAIHKA2R2B	50V 2. 2U	C1517, 1518	ECBT1E103ZF	25V 0. 01U			
C710	ECBT1E223ZF	25V 0. 022U	C1521A	ECAIHAP2R2B	50V 2. 2U			
C711, 712	ECOS1JP682CZ	63V 6800U	C1521	ECBTIH102KBS	50V 1000P			
C713	ECQE2104RF3	100V 0. 1U	C1522A	ECAIHAP2R2B	50V 2. 2U			
C715	ECEAIKKA100B	35V 10U	C1522	ECBTIH102KBS	50V 1000P			
C716	ECBTIH102KBS	50V 1000P	C1551, 1552	ECAIHAP3R3B	50V 3. 3U			
C721	ECEAIHKA010B	50V 1U	C1553, 1554	ECBTIH51KBS	50V 150P			
C731	ECFR1E1042F5	25V 0. 1U	C1555, 1556	ECEAIHKA2R2B	50V 2. 2U			
C800	ECBT1E223ZF	25V 0. 022U	C1557, 1558	ECQV1H124JZ3	50V 0. 12U			
C801	ECBT1E103ZF	25V 0. 01U	C1559, 1560	ECBT1E103ZF	25V 0. 01U			

■ CABINET PARTS LOCATION

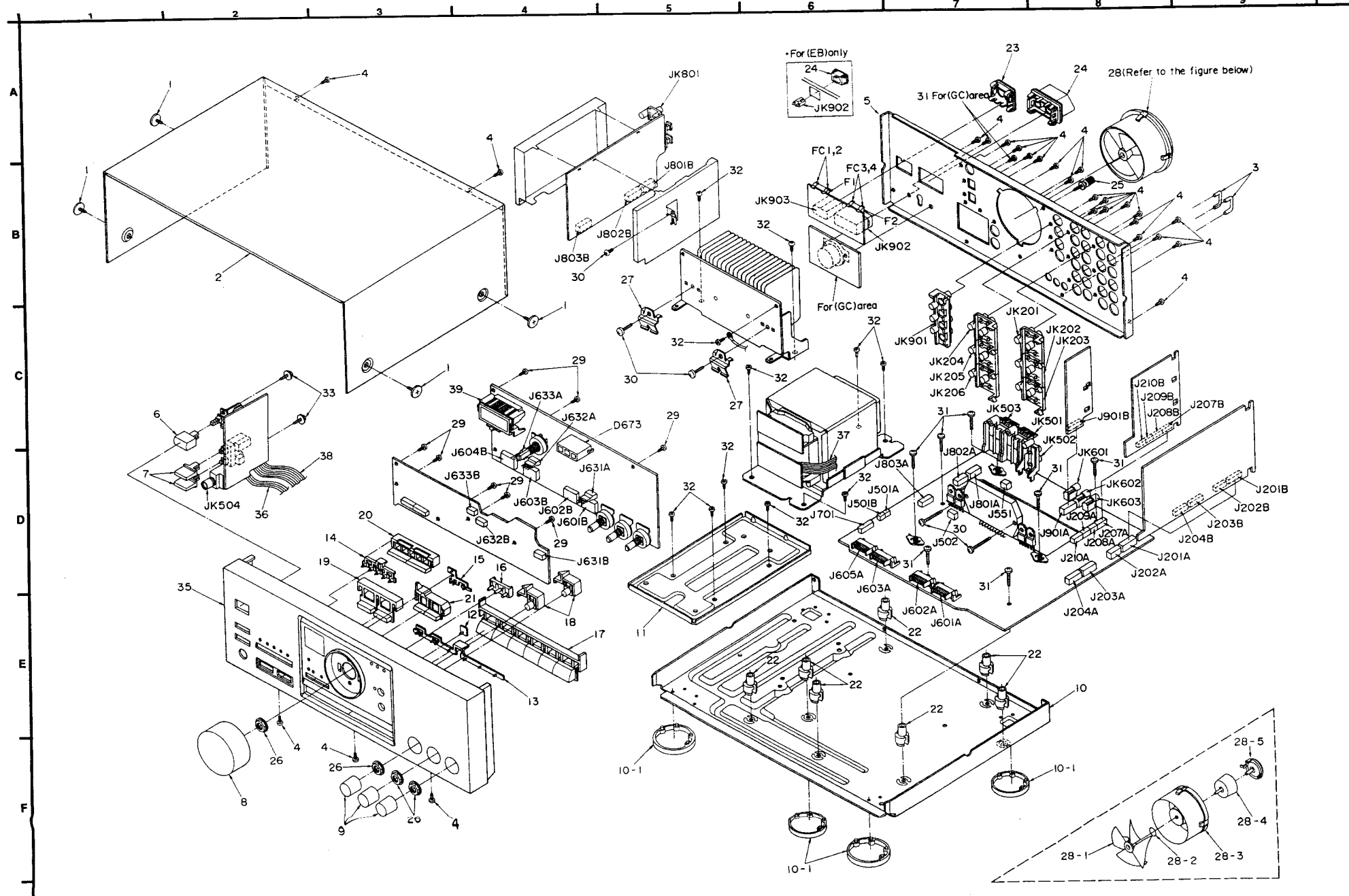

Ref. No.	Part No.	Part Name & Description	Remarks	Ref. No.	Part No.	Part Name & Description	Remarks
		CABINET PARTS				PACKING MATERIAL	
1	RHD30007	SCREW		P1	RPG0841	CARTON BOX	
2	RKMD024A-2K	COVER		P2	RPN0412	PAD	
3	SJP9205-2Y	SHORTING PIN		P3	SPSD152	ACCESSORIES BOX	
4	XTBS3+8JFZ1	SCREW		P4	XZB60X65A01Z	POLYETHYLENE COVER	
5	RGRO105C-A1	REAR PANEL	(E)			ACCESSORIES	
5	RGRO105B-A2	REAR PANEL	(EB)				
5	RGRO105C-B1	REAR PANEL	(EG)				
6	RGUD030	KNOB, POWER		A1	RQF1096	INST. MANUAL ASS'Y	(E)
7	RGUD101	KNOB, SPEAKER		A1	RQF1097	INST. MANUAL ASS'Y	(EB)
8	RGWD121-K	KNOB, MAIN VOL.		A1	RQF1098	INST. MANUAL ASS'Y	(EG)
9	RGWD125-K	KNOB, BALANCE VOL.		A1-1	RQT1000-B	INSTRUCTIONS MANUAL	(EB)
10	RFKJUX502E-K	BUTTON BOARD ASS'Y		A1-1	RQT1001-D	INSTRUCTIONS MANUAL	(EG)
10-1	RKAD011-2	FOOT		A1-1	RFKJUX502E-K	INSTRUCTIONS MANUAL	(E)
11	RMD138	PLATE		A1-2	RQAD013	WARRANTY CARD	
12	RFKJUX502EAK	PANEL LIGHT		A1-3	RQCB0169	SERVICE CENTER LIST	
13	RGL0094-X	PANEL LIGHT		A1-4	SPB1061	POLYETHYLENE COVER	
14	RGL0096-X	PANEL LIGHT		A2 Δ	SJA187	AC POWER SUPPLY CORD	(E, EG)
15	RFKJUX502EBK	PANEL LIGHT		A2 Δ	SJA188	AC POWER SUPPLY CORD	(EB)
16	RGL0131-C	PANEL LIGHT					
17	RGUD470-K1	BUTTON, SELECT					
18	RGUD471-K1	BUTTON, VOL. PRESET					
19	RGUD472-C	KNOB, S. DYNAMIC					
20	RGUD473-K1	BUTTON, S. DYNAMIC UP/DOWN					
21	RGUD474A-K	BUTTON, TAP					
22	SHE187-2	HOLDER					
23	SJS9231A	AC INLET COVER					
24	SJS9333A	AC OUTLET COVER	(E, EG)				
24	SJS9332A	AC OUTLET COVER	(EB)				
25	SNE2123	GND SCREW					
26	SNE4021-1	NUT					
27	SUS894-1	ANGLE					
28	SYE1128-2	FUN ASS'Y					
28-1	SHE232	FAN					
28-2	SUS271	SPRING					
28-3	SUS233	FAN CASE					
28-4	MDM-4RB4MRC	MOTOR					
28-5	SHE234	CAP					
29	XTBS26+8J	SCREW					
30	XTB3+16JFZ	SCREW					
31	XTB3+20JFZ	SCREW					
32	XTB3+8JFZ	SCREW					
33	XTWS3+8T	SCREW					
35	RFKJUX902E-K	FRONT PANEL ASS'Y					
36	FWJ1803200KQ	FLAT CABLE					
37	FWJ1805110KQ	FLAT CABLE					
38	FWJ1808150KQ	FLAT CABLE					
39	RMNO102	FL. HOLDER					

■ PACKAGING

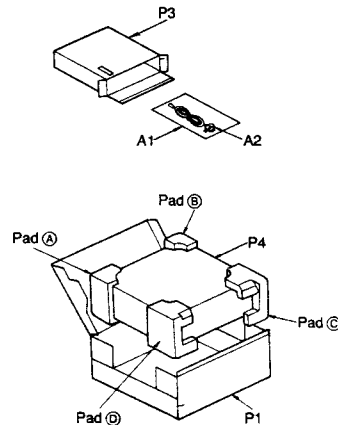

P2: Pad A ⊕ B ⊕ C ⊕ D ass'y; RPN0412

Parts Change Notice

Model No. ST-X902L (E, EB, GC, GN) (EG) (EF) (EI)
ST-X902LA (E, EB, EF, GN) (EG, EI) (GC) /SU-X902 (E, EB, EG)

Please revise the original parts list in the Service Manual to conform to the change (s) shown below. If new part numbers are shown, be sure to use them when ordering parts.

Reason for Change		*The circled item indicates the reason. If no marking, see the Notes in the bottom column.	
1. Improve performance			
2. Change of material or dimension			
3. To meet approved specification			
4. Standardization			
5. Addition			
6. Deletion			
⑦. Correction			
8. Other			

Interchangeability Code		**The circled item indicates the interchangeability. If no marking, see the Notes in the bottom column.	
Parts	Unit Production		
A	Original → Early New → Late	Original or new parts may be used in either early or late production units. Use original parts until the supply is exhausted, then stock new parts.	
B	Original → Early New → Late	Original parts may be used in early production units only. New parts may be used in either or late production units. Use original parts where possible, then stock new parts.	
Ⓒ	Original → Early New → Late	New parts are to be used in both early and late production units. Stock new parts only.	
D	Original → Early New → Late	Original parts must be used in early production units. New parts must be used in late production units only. Stock both original and new parts.	
E	Other		

Part Number Information						
Model No.	Ref. No.	Original Part No.	New Part No.	Notes (*, **)	Part Name & Description	Q'ty
TRANSISTOR						
ST-X902L / ST-X902LA	Q902	DTC144EKT96	DTC144ESTP	7,C	TRANSISTOR	
	Q911	DTC144EKT96	DTC144ESTP	7,C	TRANSISTOR	
SU-X902	Q602	DTC144EKT96	DTC144ESTP	7,C	TRANSISTOR	
	Q604	DTC144EKT96	DTC144ESTP	7,C	TRANSISTOR	

Part file this parts change notice with your copy of the Service Manual for model No. ST-X902L (E, EB, GC, GN) ST-X902L (EG) ST-X902L (EF) ST-X902L (EI) ST-X902LA (E, EB, EF, GN) ST-X902LA (EG, EI) ST-X902L (GC) SU-X902 (E, EB, EG)

Order No. AD8103043C8
Order No. AD9103059A2.
Order No. AD9104087A2.
Order No. AD9104098A2.
Order No. AD9203064A8.
Order No. AD9203065A2.
Order No. AD9204109A3.
Order No. AD9103052C2.

Technics®