

Schiebetastenschalter von oben gesehen

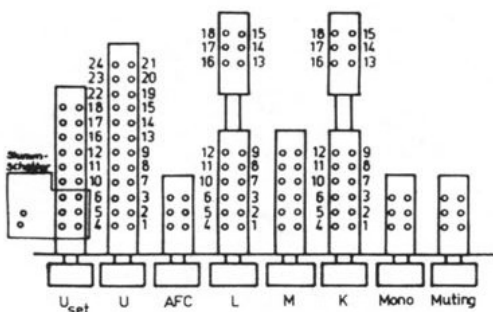

Schaltkreise auf die Anschlüsse gesehen

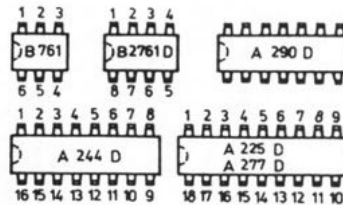

Spulen, Filter, Halbleiterbauelemente auf die Anschlüsse gesehen

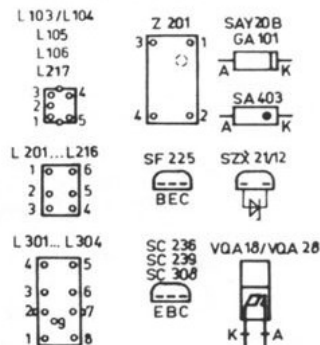

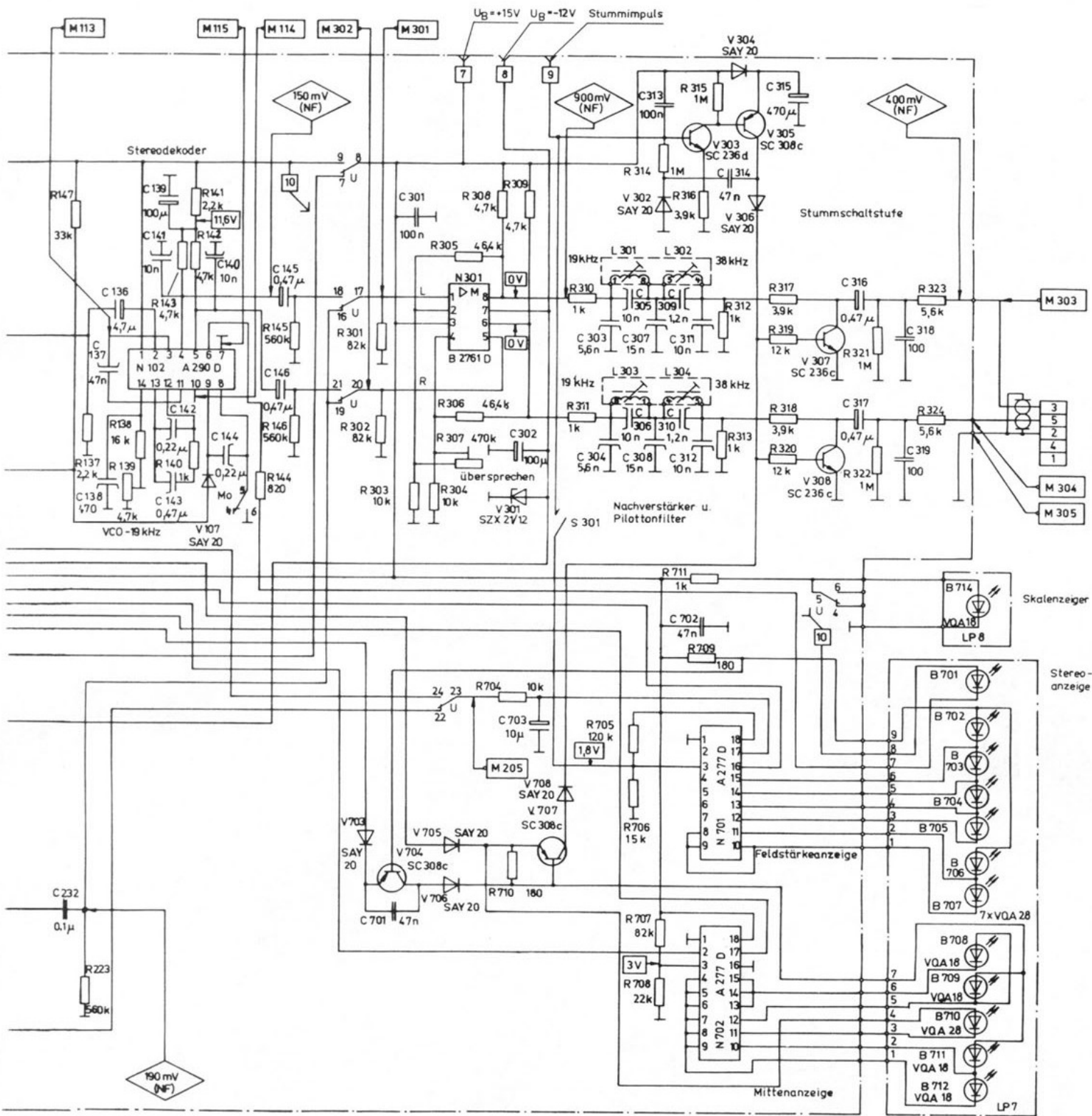

**Halbleiterbauelemente
auf die Anschlüsse gesehen**

- SC 236
- SC 237
- SC 307
- BEC
- SA 403
- MAA 550
- B 3170 V
- U 7100/U 7110
- B 081 D
- VDA 18 / VDA 28
- VDA 26

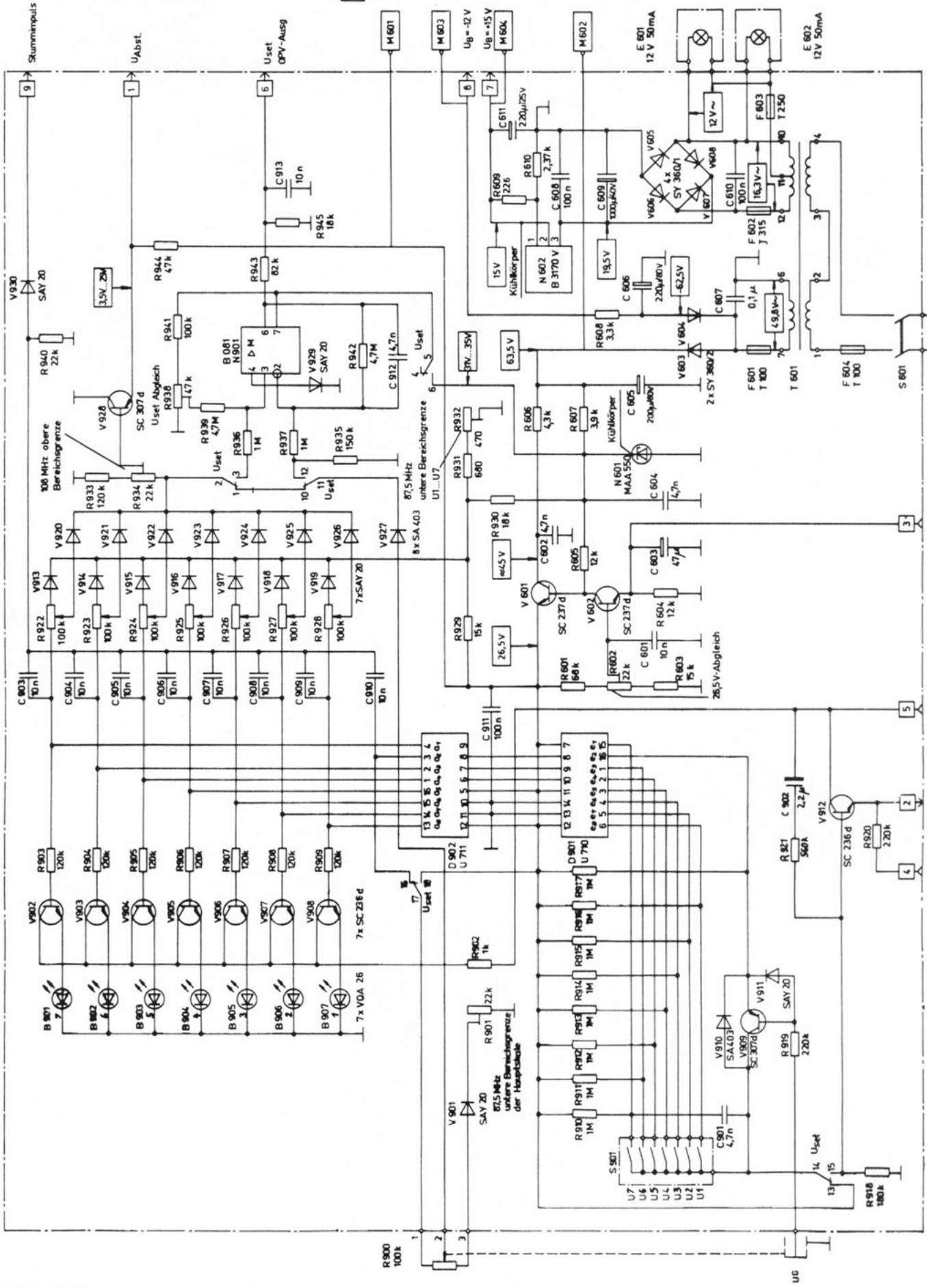
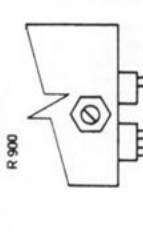
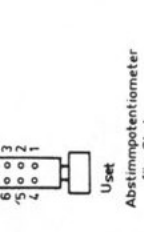
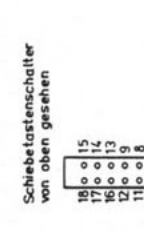
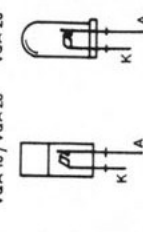
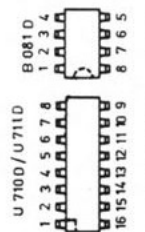
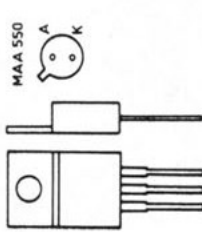

Spannungen mit Instrument R_i 2-100 kΩ/V gemessen

AFC-50mV

UB FM +15V

AFC-aus

U_{set} +15V

U_{set} +15V

Fortsetzung von Seite 173