

AMPLIFIER SCHEMATIC DIAGRAM - SCHEMA DE L'AMPLIFICATEUR - SCHALTBILD ENDVERSTÄRKER - S

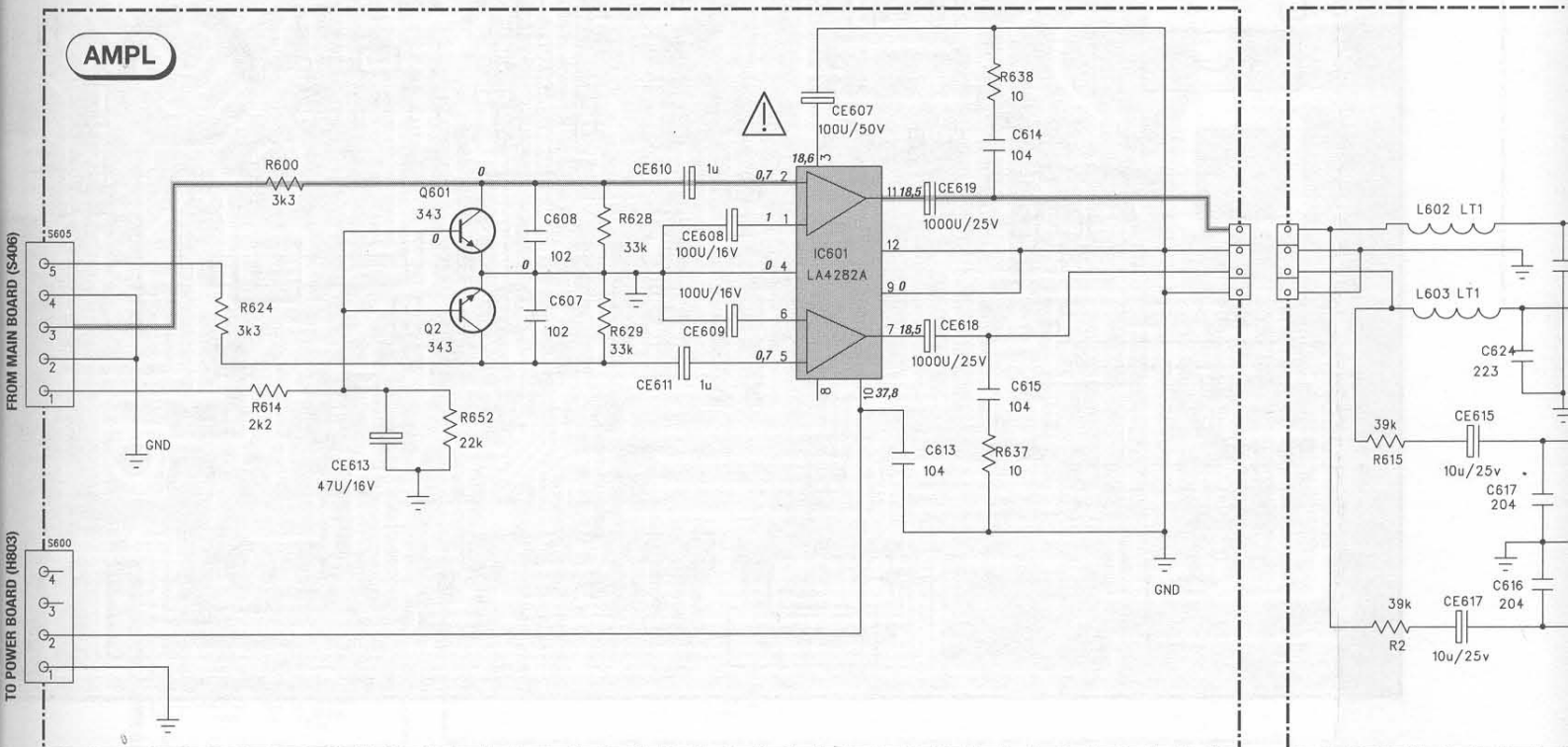

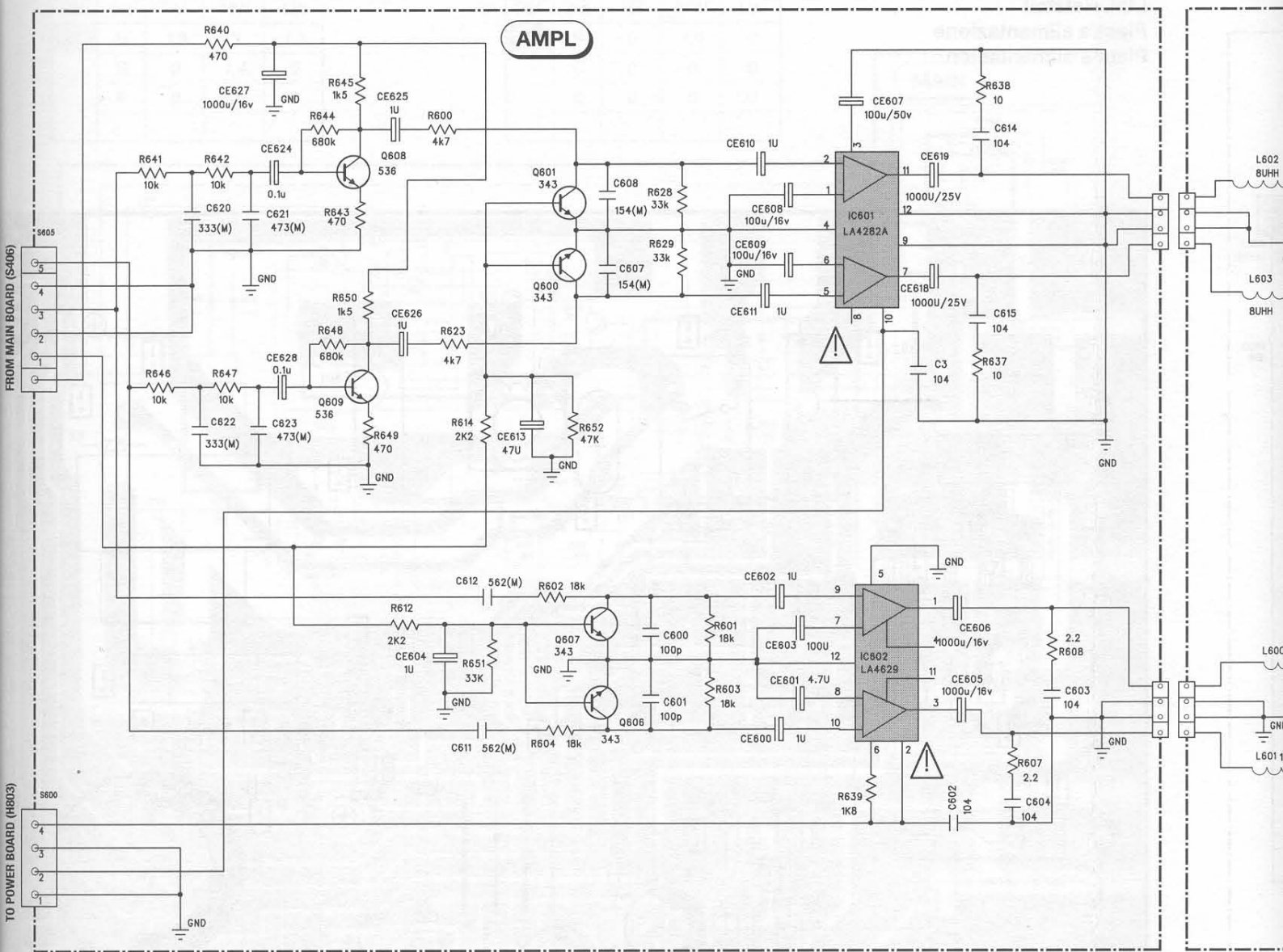





# MAIN SCHEMATIC DIAGRAM - SCHEMA DE LA PLATINE PRINCIPALE - SCHALTBILD HAUPTPLATINE

Réf.	pin	FM	MW	LW
Q402	B	1,9	0	1,9
	C	0	1,4	0
	E	0	0	0

Réf.	pin	FM	MW	LW
Q403	B	0	1,4	0
	C	0	0	0
	E	0	0	0



BILD HAUPTPLATINE - SCHEMA DELLA PIASTRA PRINCIPALE - ESQUEMA DE LA PLATINA PRINCIPAL



TO PHONE PCB BOARD (S605) TO POWER BOARD (H804)  
TO AMPL BOARD (S606)



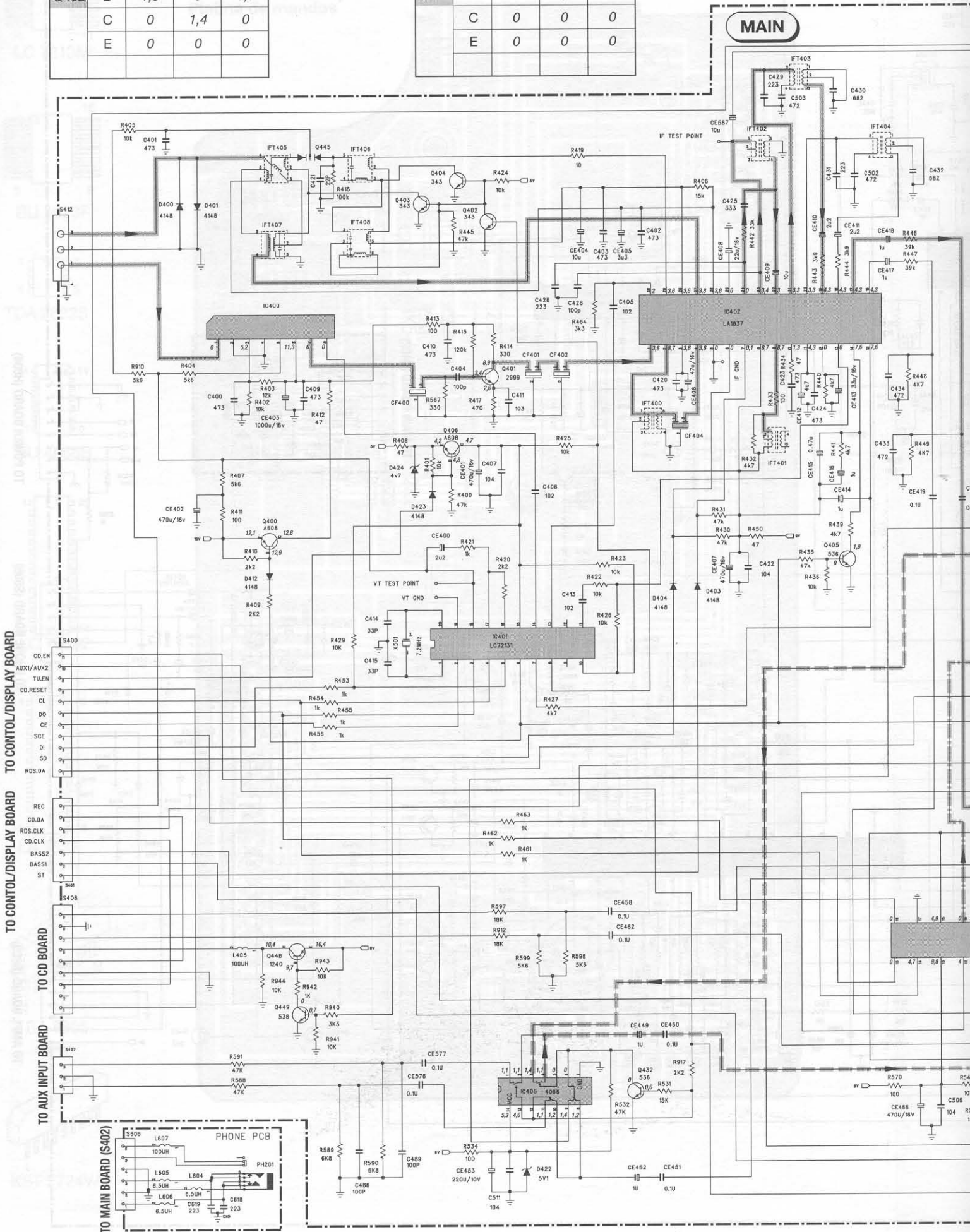
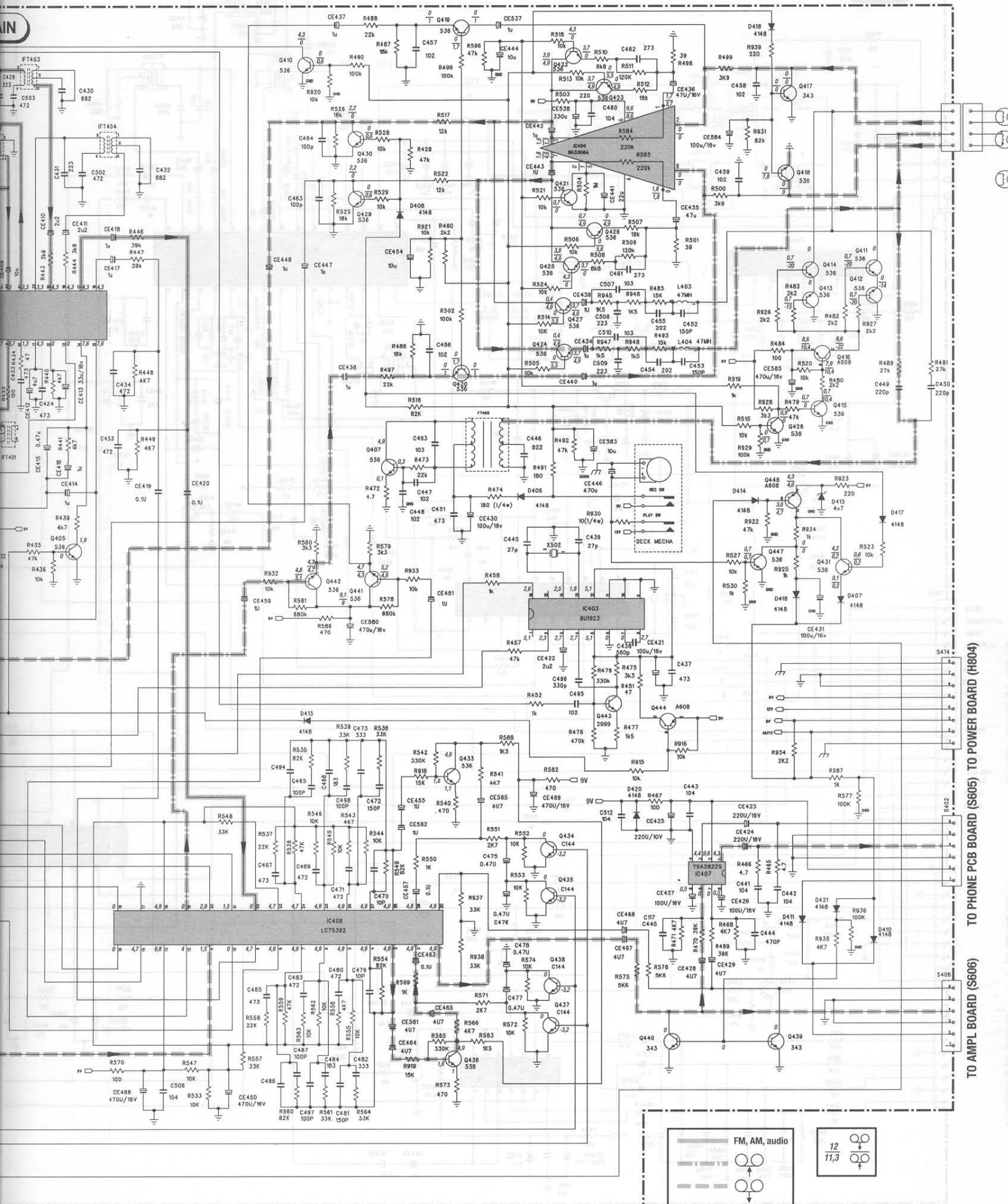
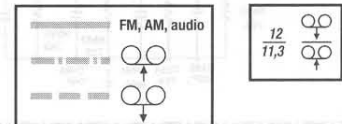

LD HAUPTPLATINE - SCHEMA DELLA PIASTRA PRINCIPALE - ESQUEMA DE LA PLATINA PRINCIPAL

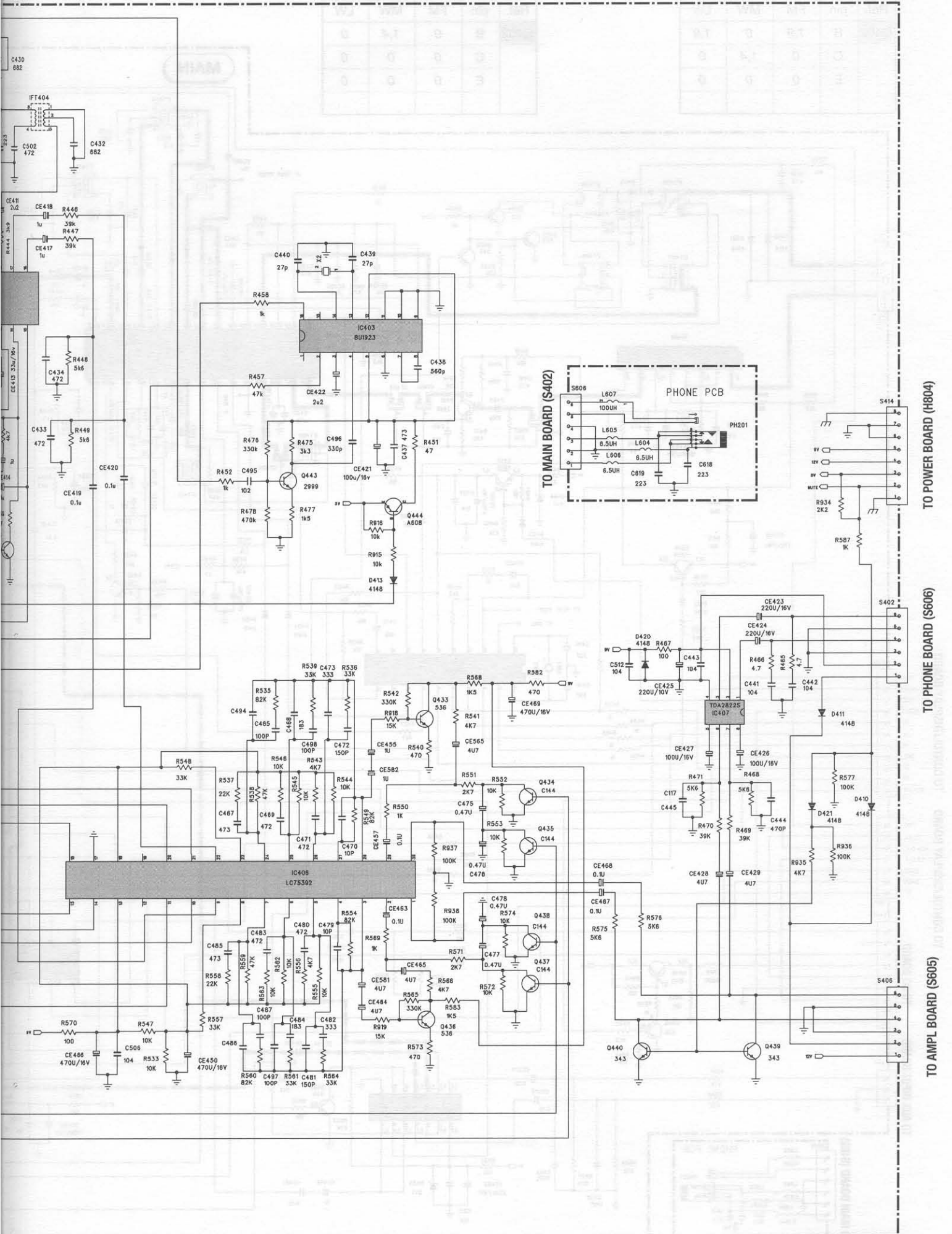



# CONTROL / DISPLAY SCHEMATIC DIAGRAM - SCHEMA COMMANDES / AFFICHEUR - SCHALTBILD BE ESQUEMA MANDOS / INDICADOR

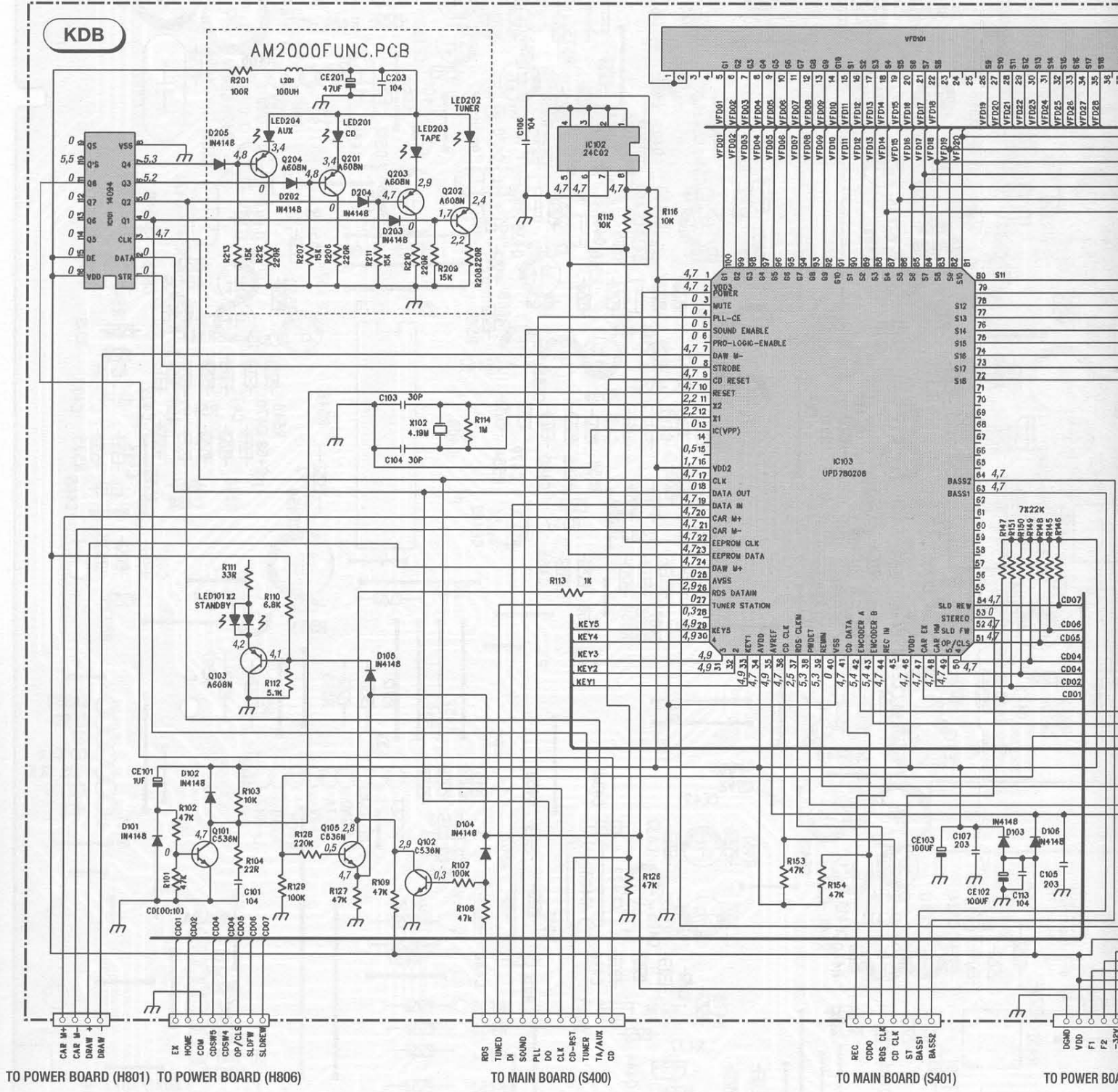



**REMOVABLE CONTROL PCB - SCHEMA DE LA COMMANDE DÉTACHABLE - SCHALTBIELD ABNEHMBARE STEUERPLATINE -  
PIASTRA CONTROLLO RIMOVIBILE - PLACA DE CONTROL EXTRAIBILE**

