



**SERVICE MANUAL
DOCUMENTATION TECHNIQUE
TECHNISCHE DOKUMENTATION
DOCUMENTAZIONE TECNICA
DOCUMENTACION TECNICA**

**THOMSON ALTIMA 3080
ALTIMA 3085**

Version (PC*): A

*PC: The version code is indicated either in the battery compartment or on the back of the unit - ce code version est indiqué dans le compartiment à piles ou au dos de l'appareil - PC: Version des Geräts wird im Batteriefach oder auf der Rückseite angegeben - il codice della versione è indicato nello scompartimento delle batterie o sul retro dell'apparecchio - el código de la versión está indicado en el compartimento de las pilas o en la parte trasera del aparato.



**Technical data - Caractéristiques principales
Technische Daten - Dati tecnici - Características del aparato**

Type of set : Type d'appareil : Geräteart : Tipo d'apparecchio : Tipo de aparato :	Cassette radio recorder / compact disc Combiné radio cassette / CD CD-Radio Cassetten Portable Insieme radio cassette / CD Radio cassette / CD		
Power supply : Alimentation : Stromversorgung : Alimentazione : Alimentación :	230 V ~ 50 Hz	Nominal output power : Puissance nominale de sortie : Nennausgangsleistung : Potenza nominale di uscita : Potencia nominal de salida :	2 x 10 W
FM - MF : MW - PO : LW - GO :	87,5 - 108 MHz 522 - 1611 kHz 150 - 283 kHz	Sensitivity : Sensibilité : Empfindlichkeit : Sensibilità : Sensibilidad :	FM - MF : 8 µV (S/N = 26 dB) MW - PO : 1000 µV/m (S/N = 20 dB) LW - GO : 2500 µV/m (S/N = 20 dB)
Frequency response : Courbe de réponse : Frequenzgang : Curva di risposta : Curva de respuesta :	125 Hz - 8 kHz (-5 dB)	Signal to noise ratio : Rapport signal / bruit : Geräuschspannungsabstand : Rapporto segnale / disturbo : Relación señal / ruido :	42 dB
Wow and flutter : Fluctuations : Gleichlauf : Fluttuazioni : Fluctuaciones :	0,2 %		4,75 cm/s C60 : 170 s
DAD Disc rotation speed : Vitesse de rotation du disque : CD-Drehgeschwindigkeit : Velocità di rotazione del disco : Velocidad de rotación del disco :	200 → 500 tr/m	Frequency response : Courbe de réponse : Frequenzgang : Curva di risposta : Curva de respuesta :	60 Hz - 20kHz (±3 dB)
Stereo separation : Diaphonie : Übersprechdämpfung : Diafonia : Diafonía :	40 dB	Signal to noise ratio : Rapport signal / bruit : Geräuschspannungsabstand : Rapporto segnale / disturbo : Relación señal / ruido :	65 dB



WARNING : Before servicing this chassis read the safety recommendations.
ATTENTION : Avant toute intervention sur ce châssis, lire les recommandations de sécurité.
ACHTUNG : Vor jedem Eingriff auf diesem Chassis, die Sicherheitsvorschriften lesen.
ATTENZIONE : Prima di intervenire sullo chassis, leggere le norme di sicurezza.
IMPORTANTE : Antes de cualquier intervención, leer las recomendaciones de seguridad.

Code : 351 913 70 - 0502 / 3M - CRKD2551 Print.



CLASS 1 LASER PRODUCT
APPAREIL A LASER DE CLASSE 1
LASER KLASSE 1
APPARECCHIO CON LASER DI CLASSE 1
APARATO CON LASER DE CLASE 1

- DANGER :** Invisible laser radiation when open and interlock failed or defeated. Avoid direct exposure to beam.
- ATTENTION :** Le rayon laser est invisible. Eviter l'exposition directe lors de la maintenance.
- VORSICHT BEI REPARATUREN :** Bei geöffneter Schublade und Defekt der Sicherheitsvorrichtungen besteht die Gefahr unsichtbaren Laserlichts. Niemals direkt in den Laserstrahl sehen.
- ATTENZIONE :** Il raggio laser è invisibile. Evitare l'esposizione diretta durante la manutenzione.
- IMPORTANTE :** El rayo laser es invisible. Evitar la exposición directa en el momento del mantenimiento.

DIGITAL PROCESSING SCHEMATIC DIAGRAM - SCHEMA DU TRAITEMENT DIGITAL - SCHALTBILD DIGITALVERARBEITUNG - SCHEMA ELABORAZIONE DIGITALE - ESQUEMA DEL TRATAMIENTO DIGITAL

The complete Digital Processing Module is available from A. S. S. under Part Number :
En SAV, l'ensemble du module traitement digital est géré sous le code :
Die Service Bestell-Nr. für das Modul "Digital Processing kompl." ist :
Il codice del modulo completo di elaborazione digitale è :
En postventa, el modulo completo tratamiento digital lleva el código :

107 468 60

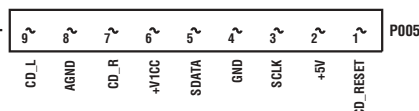

AMPLIFIER AND POWER SUPPLY SCHEMATIC DIAGRAM - SCHEMA DE L'AMPLIFICATEUR ET DE L'ALIMENTATION - SCHALTBILD ENDVERSTÄRKER UND NETZTEIL - SCHEMA DEL AMPLIFICATORE E DELL' ALIMENTAZIONE - ESQUEMA DEL AMPLIFICADOR Y DE LA ALIMENTACIÓN

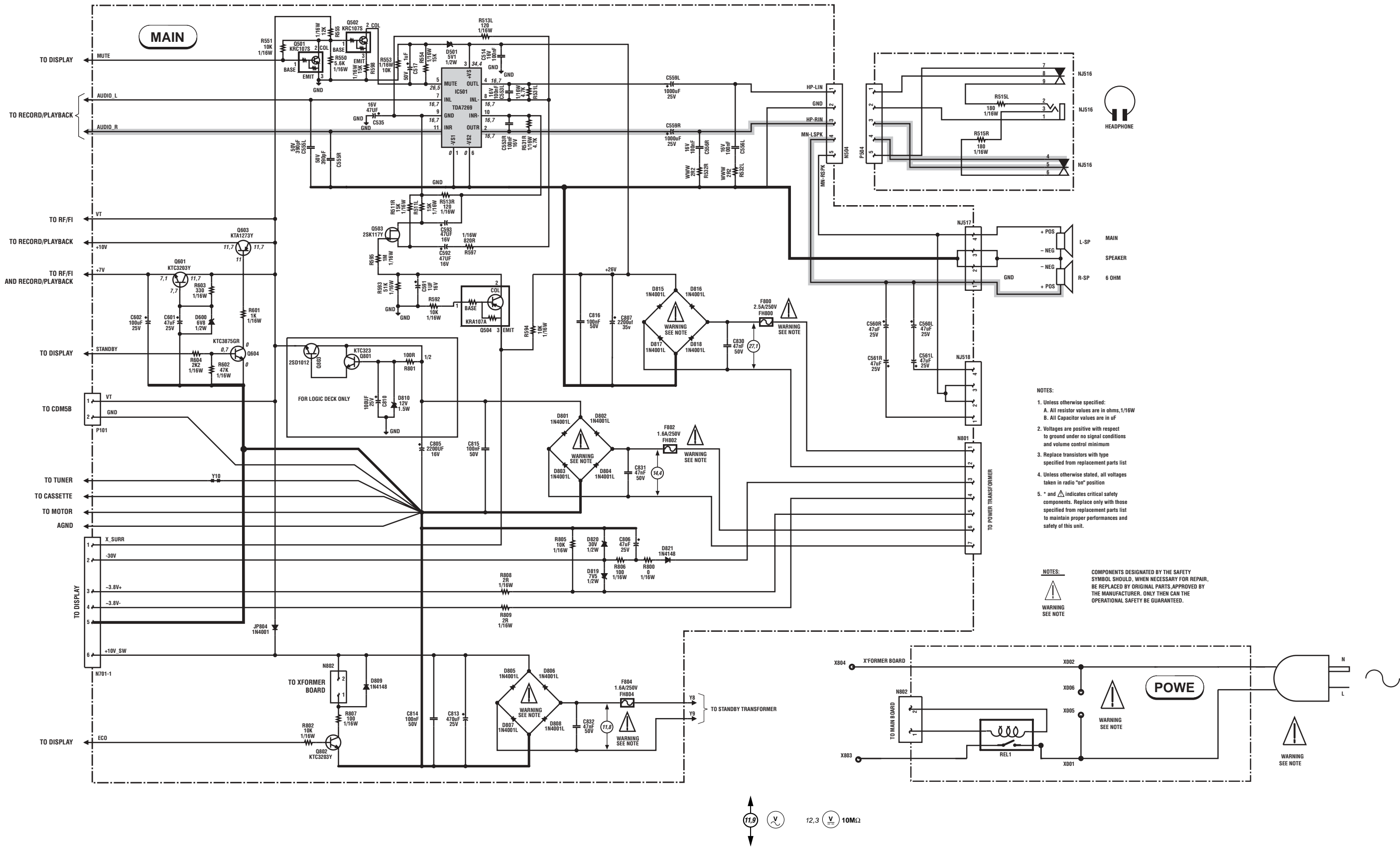

- NOTES:
- 1. Unless otherwise specified:
A. All resistor values are in ohms, 1/16W
B. All Capacitor values are in uF
 - 2. Voltages are positive with respect to ground under no signal conditions and volume control minimum
 - 3. Replace transistors with type specified from replacement parts list
 - 4. Unless otherwise stated, all voltages taken in radio "on" position
 - 5. * and ⚠ indicates critical safety components. Replace only with those specified from replacement parts list to maintain proper performances and safety of this unit.

NOTES:
⚠ COMPONENTS DESIGNATED BY THE SAFETY SYMBOL SHOULD, WHEN NECESSARY FOR REPAIR, BE REPLACED BY ORIGINAL PARTS, APPROVED BY THE MANUFACTURER. ONLY THEN CAN THE OPERATIONAL SAFETY BE GUARANTEED.



Control / display P.C.B.
 Platine commandes / afficheur
 Ltpl. Bedienteil / Anzeige
 Piastra comandi / indicatore
 Platina de mandos / indicador

Component side
 Côté composants
 Bestückungsseite
 Lato componenti
 Lado componentes

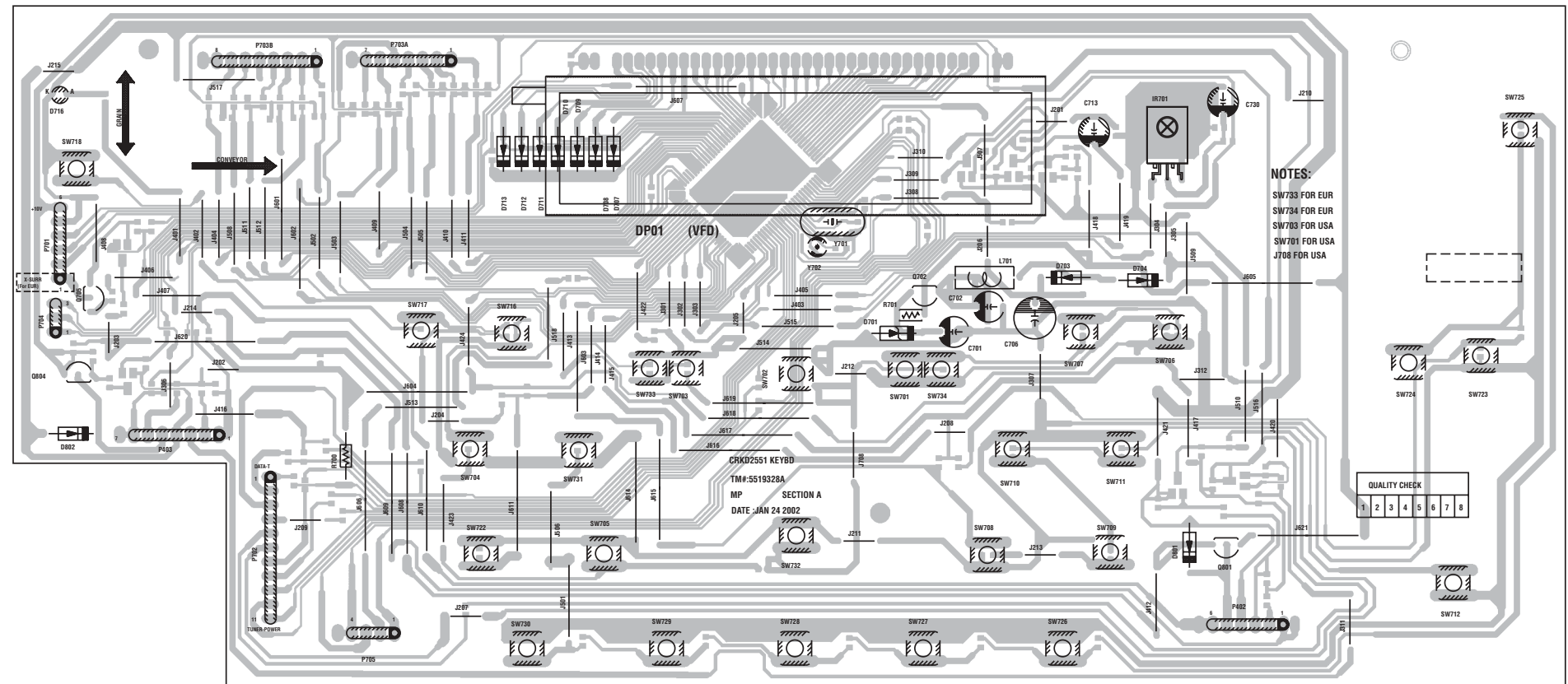



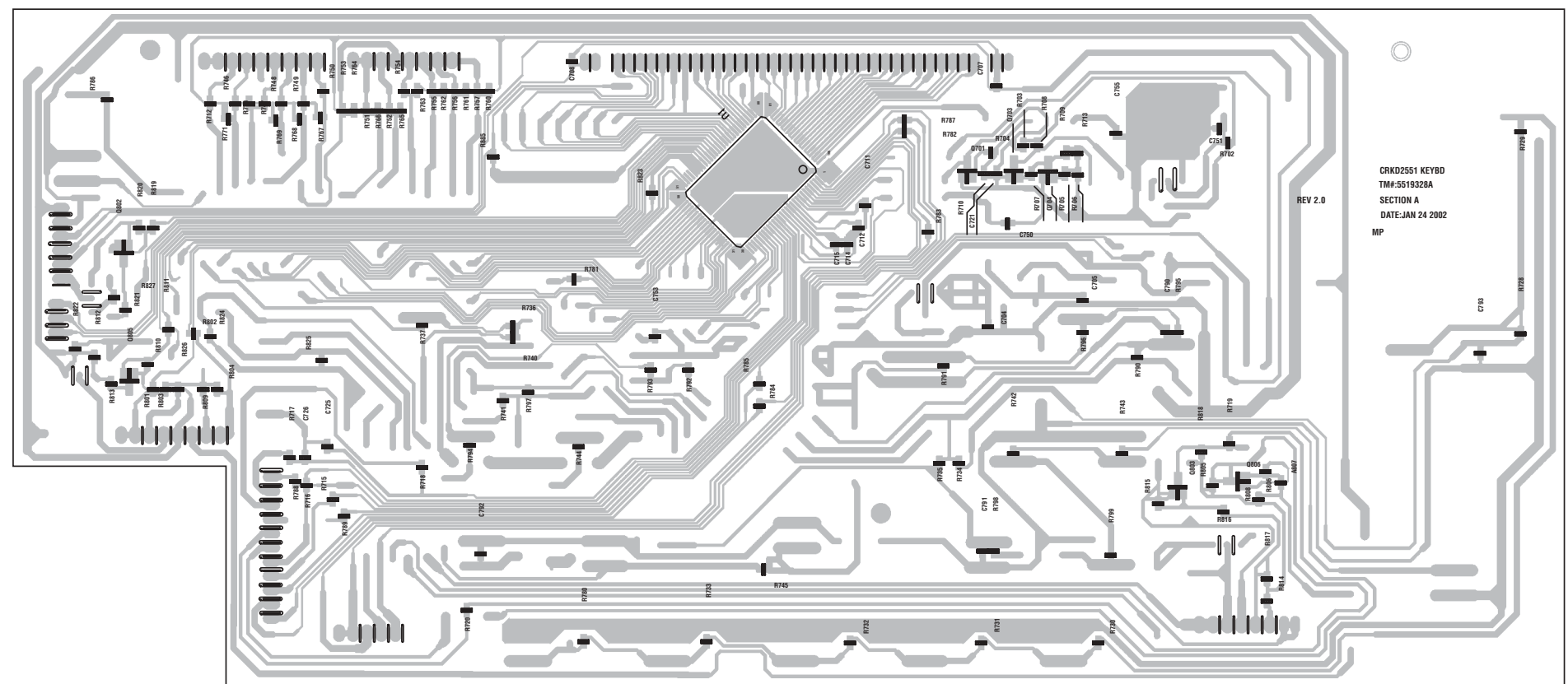



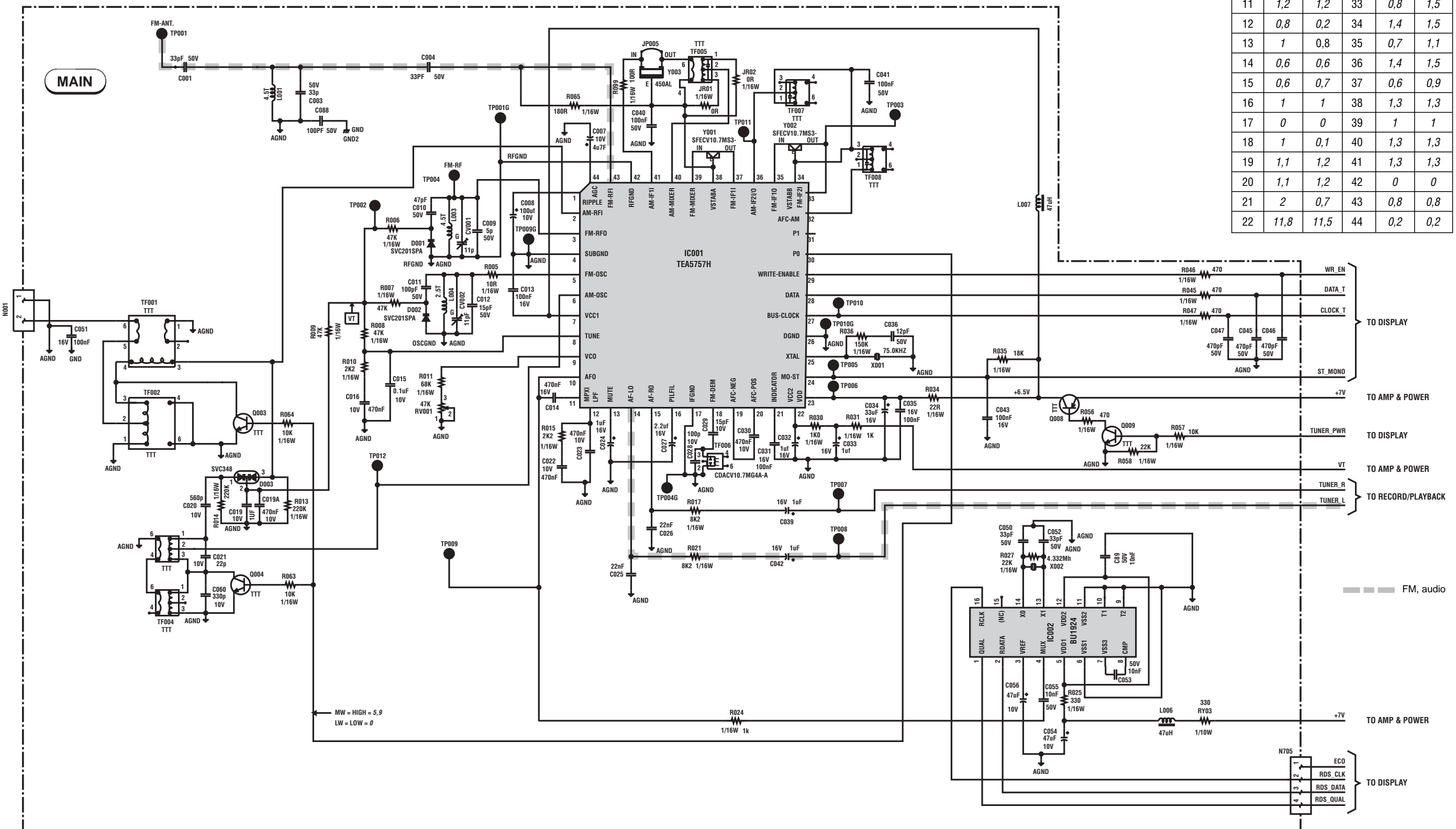





Solder side
 Côté cuivre
 Lötseite
 Lato saldature
 Lado del cobre





















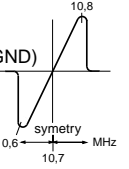



IC001	FM	AM		FM	AM
1	2,1	2,1	23	7,1	7
2	0	0	24	-	5,5
3	0	0	25	1,4	1,4
4	0	0	26	0	0
5	0	0	27	CLOCK	CLOCK
6	0	0	28	DATA	DATA
7	7,1	7,1	29	WRITE	WRITE
8	VTO	VTO	30	P0	P0
9	1	1,3	31	P1	P1
10	0,7	0,8	32	1,4	1,3
11	1,2	1,2	33	0,8	1,5
12	0,8	0,2	34	1,4	1,5
13	1	0,8	35	0,7	1,1
14	0,6	0,6	36	1,4	1,5
15	0,6	0,7	37	0,6	0,9
16	1	1	38	1,3	1,3
17	0	0	39	1	1
18	1	0,1	40	1,3	1,3
19	1,1	1,2	41	1,3	1,3
20	1,1	1,2	42	0	0
21	2	0,7	43	0,8	0,8
22	11,8	11,5	44	0,2	0,2



ADJUSTMENTS - REGLAGES - EINSTELLUNGEN - REGOLAZIONE - AJUSTES

AM alignment						
		  	f	 18888 KHZ	 	  
MW Osc	1		522 kHz	522 kHz	TF003	TP002 V = 1,35V ±0,05V (TP009G = AGND)
	2		1611 kHz	1611 kHz		TP002 V = 8,0V ±1V
LW Osc	3		150 kHz	150 kHz	TF003	TP002 V = 1,51V ±0,1V
	4		283 kHz	283 kHz		TP002 V = 4,6V ±1V
IF	4	 Ve = 100 mV	450 kHz	450 kHz	TF007	TP011 V = 450 kHz ±1 kHz
MW	5	 Ve = 300 µV	630 kHz	630 kHz	TF001	TP007 max. TP008 (TP009G = AGND)
LW	6		170 kHz	170 kHz	TF002	

FM alignment							
		  	f	 18888 KHZ	 	  	
IF	1	 Ve = 1 mV	98,1 MHz	98,1 MHz	TF006	 TP003 (TP009G = AGND) f = 10,7 kHz ±5 kHz symmetry 10,6 MHz 10,7 MHz 10,8 MHz	
	2		87,5 MHz	87,5 MHz	L004		TP002 VT = 1,0V ±0,05V VT = 7,0V ±0,5V
	3		108,1 MHz	108,1 MHz	CV002		
RF	4	 Ve = 1 mV	90,1 MHz	90,1 MHz	L003	TP007 max. TP008 (TP009G = AGND)	
	5		106,1 MHz	106,1 MHz			

Decoder alignment						
		  	f	 18888 KHZ	 	  
FM	1	Ve = 1 mV 	98,1 MHz	98,1 MHz	RV001	TP005 f = 152 kHz ±1 kHz TP010G = DGND

RECORD / PLAYBACK SCHEMATIC DIAGRAM - SCHEMA ENREGISTREMENT / LECTURE - SCHALTBILD AUFNAHME / WIEDERGABE - SCHEMA REGISTRAZIONE / RIPRODUZIONE - ESQUEMA GRABACIÓN / REPRODUCCIÓN

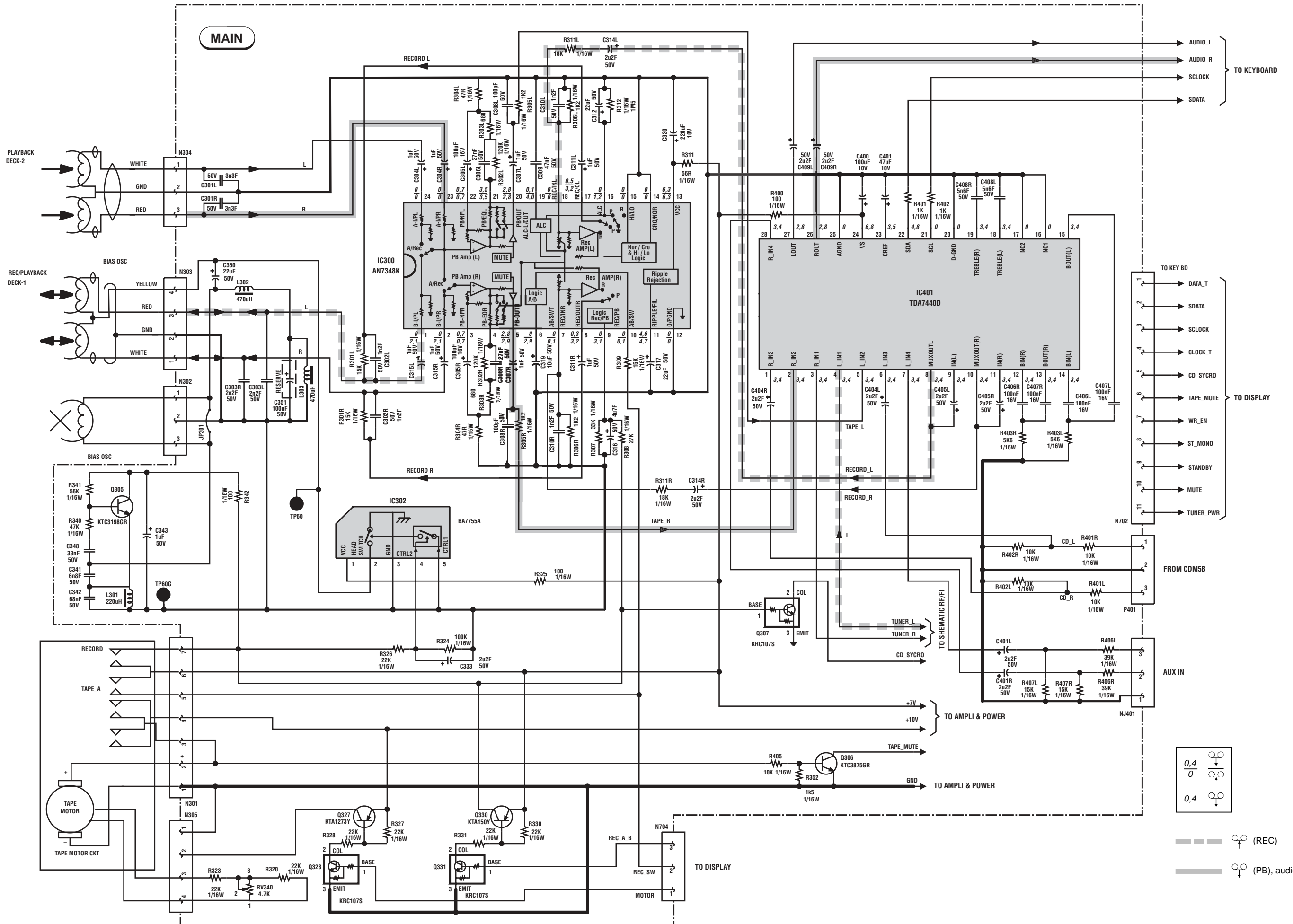

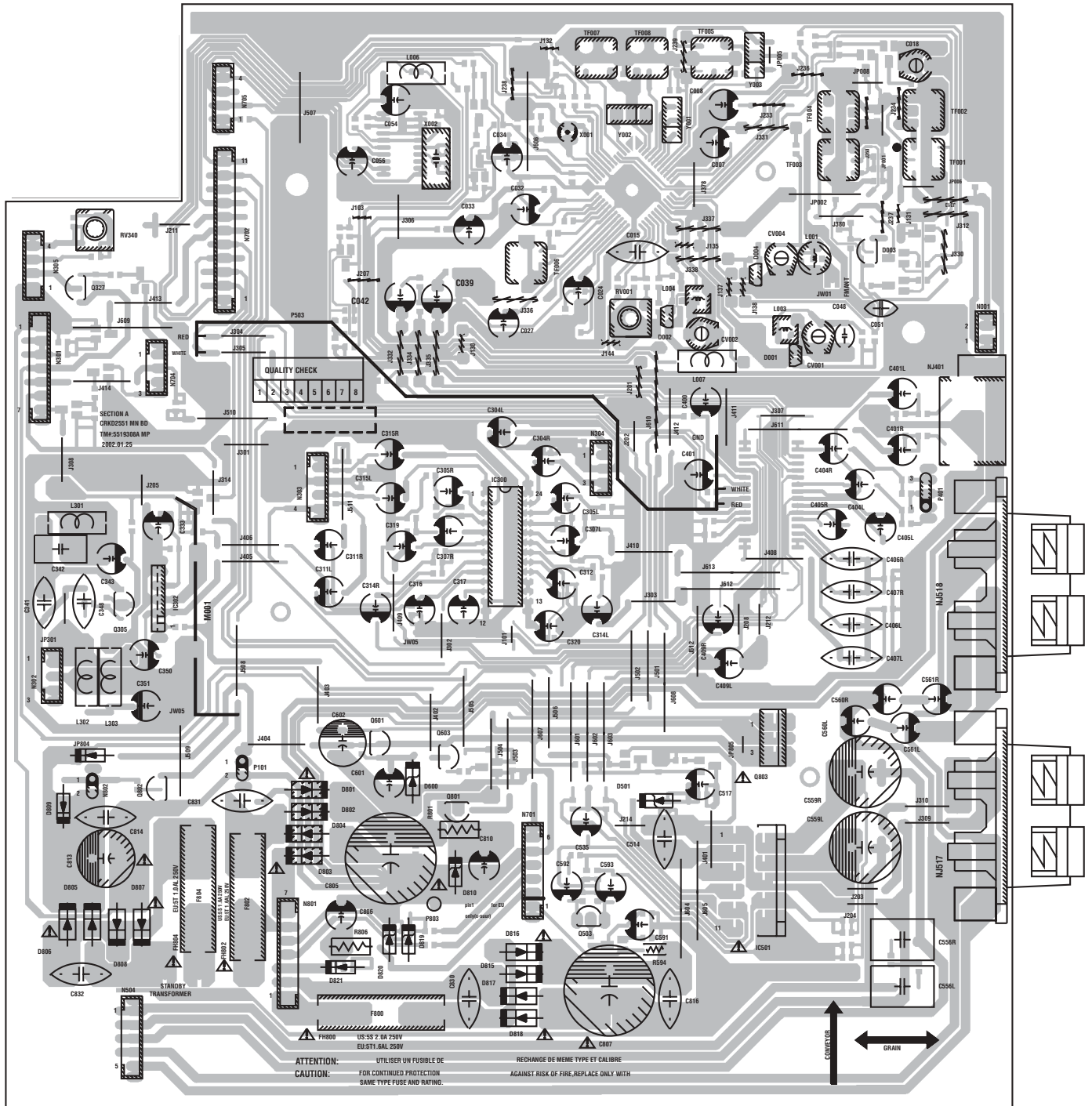

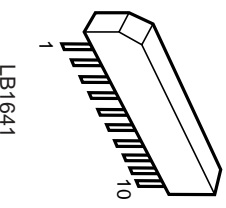
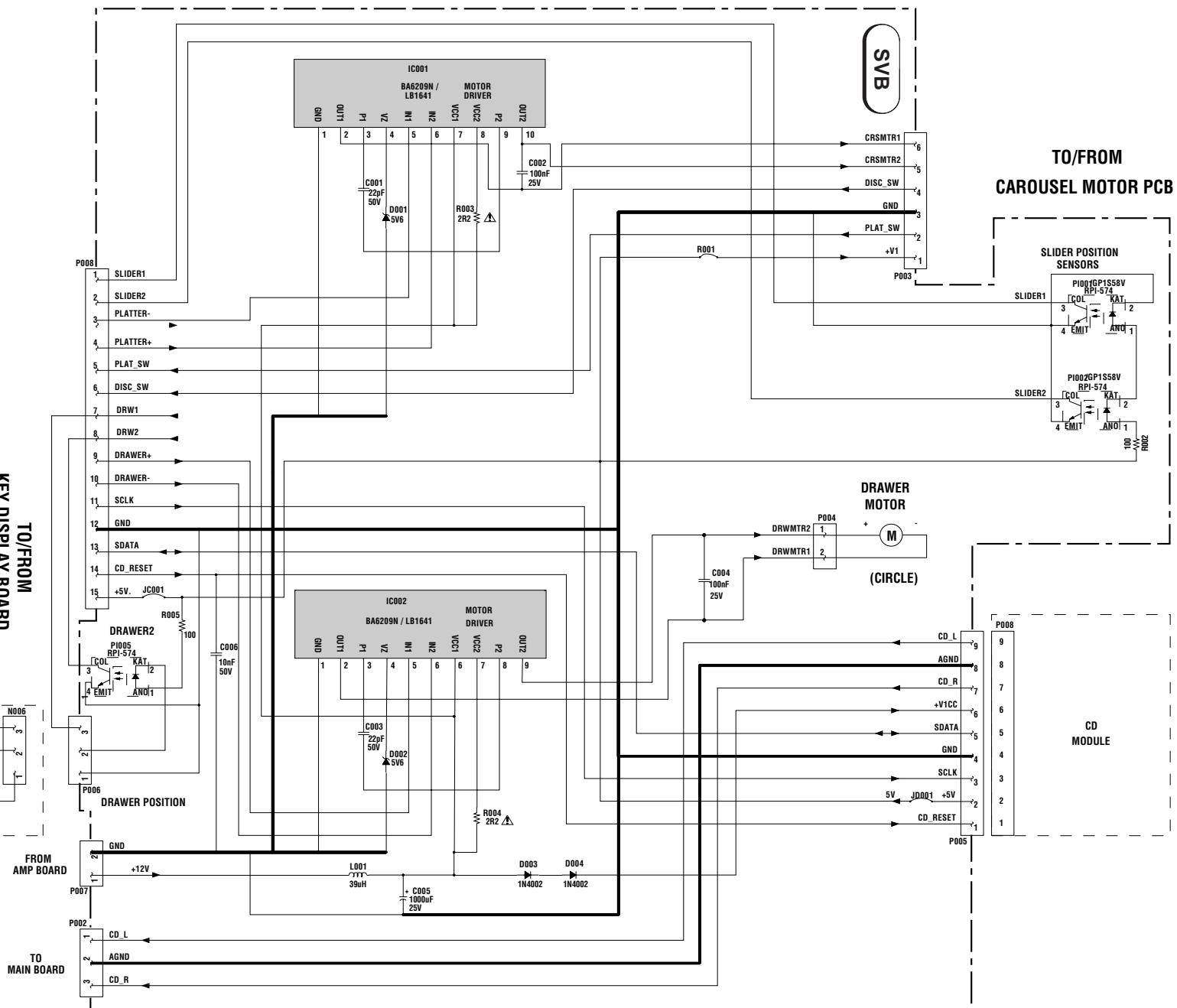

TO/FROM
 KEY DISPLAY BOARD

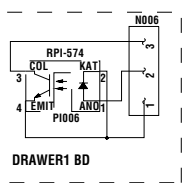

Power unit P.C.B.
Platine secteur
Netzanschluss Ltpl.
Piastra di rete
Platina de red

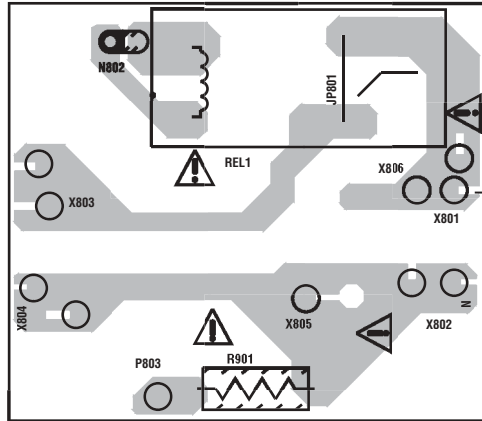

Headphone-jack P.C.B.
Platine prise-casque
Ltpl. Kopfhörerbuchse
Piastra presa per cuffia
Platina toma auriculares

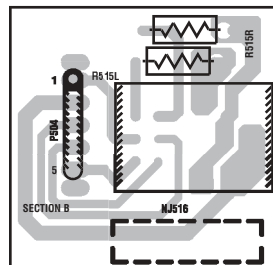

PARTS LIST
LISTE PIECES DETACHEES
ERSATZTEILLISTE
LISTA PARTI DI RICAMBIO
LISTA DE PIEZAS DE REPUESTO



THOMSON
ALTIMA3080
Chassis CRKD2551

MODULES

MAIN	MAIN	R 55192980
KDB	DISPLAY/CONTROL	R 55193220
SVB	CD CONTROL	R 55151850



IC001,002 (SVB)	FAN8082	△ 55116380
IC001 (MAIN)	TEA5757H	20955120
IC002 (MAIN)	BU1924F FLAT	55048400
IC300	AN7348K	20693340
IC302	BA7755A	10214460
IC401	TDA7440D FLAT	55097860
IC501	TDA7269	10348790
IC701	UPD780205AGF-012-3BA FLAT	55233020
IR701	GP1U287R	20852030



PI001,002,005,006	RPI-576	55098050
PI003	RPI-574	20586840
PI004	GP2S28	20556130
Q003,004,009,502,604,701,703,704,802,803,805,806	KTC3875GR SMD	20779850
Q008,330	KTA1504GR SMD	20779750
Q305,601,702,705,801,802	KTC3203Y/KTC2120Y	20538220
Q327,801,804	KTA1271Y	20685080
Q328,331,501	KRC107S SMD	55051240
Q503	2SK117Y	35095520
Q504	KRA107S SMD	55051260
Q603	KTA1273Y/KTA966Y	10448970
Q803	2SD2012	10221820



D001 (SVB)	1N5232B 5.6V	20414280
D001,002(MAIN)	SVC201SP	10281340
D002 (SVB)	1N5235B	20526990
D003 (MAIN)	SVC348	55104590
D003,004,821	1N4002	11070780
D501	1N5231B/HZ5C1	35033870
D600,819	BZX55C7V5	80444150
D701	BZX55C6V2 500MW	20475410
D703,704,707,708,709,710,711,712,801,802,805,806,807,808,809	1N4148	44009209
D716	L314-SRD LED	20971500
D801,802,803,804,JP804	1N4001	16008160
D810	BZX85C12	70437720
D815,816,817,818	1N5392	10232130
D820	BZX85C30	30948640



TF001	796KHZ 400UH	55103950
TF002	252KHZ	55104000
TF003	104UH	55103970
TF004	796KHZ 110UH	55104260
TF005	460KHZ	55103990
TF006	11MHZ	55103940
TF007,008	442KHZ	55103980
X001	75KHZ	55106010
X002	4M332HZ	55050710
Y001,002	10M7HZ	20906450
Y701	4M194HZ	20496690
Y702	32K768HZ	55093470



RV001	4K7 OHM	55125730
RV340	4K7 OHM	10368440

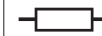

R003,004	2R2 OHM 5% 0,25W	△ 15009870
----------	------------------	------------



POWER	△ 55215940
STAND-BY	△ 55215160

R : RECYCLED PART
: PIECE RECYCLEE
: AUSTAUSCHTEILE
: RICAMBIO RICICLATO
: MODULO REPROCESADO

For any requests, please contact THOMSON multimedia after sales service area
 Pour toutes précisions, contactez votre service apres vente local THOMSON multimedia
 Für weitere Auskünfte, wenden Sie sich bitte an die THOMSON multimedia Kundendienst
 Per precisazioni, contattate l'assistenza tecnica THOMSON multimedia
 Para cualquier pregunta, por favor contactar con el responsable de zona del servicio postventa de THOMSON multimedia

VERSION 1 03 / 2002 35191360
VERSION 2 00 / 0000

**OTHER PARTS
AUTRES PIECES
SONSTIGE TEILE
ALTRE PARTI
OTRAS PIEZAS**

F800,802	1A6T 250V TIME-LAG FUSE Δ 48064700 1A6T 250V FUSIBLE TEMPORISE 1A6T 250V SICHERUNG 1A6T 250V FUSIBILE TEMPORIZZATO 1A6T 250V FUSIBLE TEMPORIZADO	
F804	1AT 250V TIME-LAG FUSE Δ 48070100 1AT 250V FUSIBLE TEMPORISE 1AT 250V SICHERUNG 1AT 250V FUSIBILE TEMPORIZZATO 1AT 250V FUSIBLE TEMPORIZADO	
NJ401	CINCH SOCKET 55051030 PRISE CINCH CHINCH-BUCHSE PRESA CINCH TOMA CINCH	
NJ516	JACK SOCKET 20369030 PRISE JACK BUCHSE PRESA JACK TOMA JACK	
NJ517	LOUDSPEAKER SOCKET 20604680 PRISE HAUT PARLEUR LAUTSPRECHERBUCHSE PRESA ALTOPARLANTE TOMA HEMBRA ALTAVOZ	
RLY1	SDT-S-112LMR RELAY 12V 35095470 SDT-S-112LMR RELAIS 12V SDT-S-112LMR RELAYS 12V SDT-S-112LMR RELEE 12V SDT-S-112LMR RELEE 12V	
SW702,704, 705,706,707, 708,709,710, 711,712,716, 717,718,722, 723,724,725, 726,727,728, 729,730,731, 732,733,734	MICROSWITCH 20404730 MICROCONTACTEUR MIKROSCHALTER MICROINTERRUTTORE MICROCONTACTOR	
X701	DISPLAY LCD 55318730 AFFICHEUR LCD LCD-ANZEIGE VISUALIZZATORE LCD VISUALIZADOR LCD	

**EQUIPMENT/PRESENTATION
EQUIPEMENT/PRESENTATION
AUSSTATTUNG/GEHAEUSE
PARTI VARIE
EQUIPO/PRESENTACION**

A3080 (REMOTE CONTROL) 55201050 A3080 (TELECOMMANDE) A3080 (FERNBEDIENUNG) A3080 (TELECOMANDO) A3080 (TELEMANDO)	
LOUDSPEAKER BOX ASSY RIGHT AND LEFT 55210320 ENCEINTE ACOUSTIQUE GAUCHE ET DROITE LAUTSPRECHERBOX RECHTS UND LINKS CASSA ACUSTICA DESTRO E SINISTRO CAJA ACUSTICA DERECHA Y IZQUIERDA	
LOUDSPEAKER BOX RIGHT OR LEFT 35193360 ENCEINTE ACOUSTIQUE GAUCHE OU DROITE LAUTSPRECHERBOX RECHTS ODER LINKS CASSA ACUSTICA SINISTRA O DESTRA CAJA ACUSTICA IZQUIERDA O DERECHA	
FITTING REAR 55250740 CALE ARRIERE POLSTER HINTEN Distanziatore posteriore CALZO TRASERA	
FITTING FRONT 55250730 CALE AVANT POLSTER VORN Distanziatore anteriore CALZO DELANTERA	
FOLDING BOX 55237610 EMBALLAGE CARTON KARTON IMBALLGGIO CARTONE EMBALAJE CARTON	
AM ANTENNA 20690640 ANTENNE AM AM ANTENNE ANTENNA AM ANTENA AM	
AM ANTENNA HOLDER 20690520 SUPPORT ANTENNE AM AM ANTENNENHALTER SUPPORTO ANTENNA AM SOPORTE ANTENA AM	
POWER SUPPLY LEAD Δ 10260820 CORDON D'ALIMENTATION NETZKABEL CAVO DI ALIMENTAZIONE CABLE DE ALIMENTACION	

**ACCESSORIES
ACCESSOIRES
ZUBEHOER
ACCESSORI
ACCESORIOS**

LC20 CD DVD CD-ROM LENS CLEANER 35128640 LC20 NETTOYEUR DE LENTILLE CD DVD CD-ROM LC20 LINSREINIGER FÜR CD DVD CD-ROM LC20 PULITORE PER LENTI DI CD DVD CD-ROM LC20 LIMPIADOR DE LENTE CD DVD CD-ROM	
--	--

**MECHANISM
MECANIQUE
MECHANIK
MECCANICA
MECANISMO**

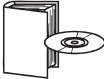
TCM130-2IWD + 5CD MECHANISM ASSY 55159380 TCM130-2IWD + MECANISME 5CD EQUIPE TCM130-2IWD + 5CD-WECHSLER K.P.L TCM130-2IWD + MECCANISMO 5CD COMPLETO TCM130-2IWD + MECANISMO 5CD EQUIPADO	
TCM130-2IWD OPTICAL PLAYER 10746860 TCM130-2IWD LECTEUR OPTIQUE TCM130-2IWD CD-LAUFWERK TCM130-2IWD ASSIEME OTTICA TCM130-2IWD MECANISMO OPTICO	
CASSETTE MECHANISM 55235110 MECANIQUE CASSETTE CASSETTENLAUFWERK MECCANICA CASSETTA MECANISMO CASSETTE	
RUBBER BELT (MOTOR) D:36,5MM 55073350 COURROIE CAOUTCHOUC (MOTEUR) D:36,5MM ANTRIEBSRIEMEN (MOTOR) D:36,5MM CINGHIA DI GOMMA (MOTORE) D:36,5MM CORREA DE GOMA (MOTOR) D:36,5MM	
RUBBER BELT (TABLE) D:23MM 20710160 COURROIE CAOUTCHOUC (POS.PLATEAU) D:23MM ANTRIEBSRIEMEN (TELLER) D:23MM CINGHIA DI GOMMA (PIATTO) D:23MM CORREA DE GOMA (PLATO) D:23MM	
BUSH RUBBER CD FRONT 20446740 AMORTISSEUR CAOUTCHOUC CD AVANT DAEMPFER GUMMI CD VORN AMMORTIZZATORE DI GOMMA CD ANTERIORE AMORTIGUADOR DE GOMA CD DELANTERA	
BUSH RUBBER CD REAR 20365070 AMORTISSEUR CAOUTCHOUC CD ARRIERE DAEMPFER GUMMI CD HINTEN AMMORTIZZATORE DI GOMMA CD POSTERIORE AMORTIGUADOR DE GOMA CD TRASERA	
	
ALTIMA3080 UM TH 55237620 ALTIMA3080 NU TH ALTIMA3080 BA TH ALTIMA3080 IU TH ALTIMA3080 IU TH	
CRKD2551 TH SERVICE MANUAL 35191370 CRKD2551 TH DOCUMENTATION TECHNIQUE CRKD2551 TH TECHNISCHE DOKUMENTATION CRKD2551 TH DOCUMENTAZIONE TECNICA CRKD2551 TH DOCUMENTACION TECNICA	
A3080 PARTS LIST 35191360 A3080 LISTE DE PIECES DETACHEES A3080 ERSATZTEILLISTE A3080 LISTA PARTI DI RICAMBIO A3080 LISTA DE PIEZAS DE REPUESTO	

**CHASSIS AND PRESENTATION
CHASSIS ET PRESENTATION
CHASSIS UND GEHAEUSETEILE
TELAIO E DI PRESENTAZIONE
CHASIS Y PRESENTACION**

MAIN	MAIN BOARD MAIN PLATINE MAIN PLATTE MAIN PIASTRA MAIN PLATINA	55192980
040	FRONT PANEL FACADE FRONTPLATTE PANNELLO FRONTALE PANEL FRONTAL	55234110
060	SIDE PANEL LEFT PANNEAU LATERAL GAUCHE SEITENTEIL LINKS PANNELLO LATERALE SINISTRO PANEL LATERAL IZQUIERDO	55234130
070	SIDE PANEL RIGHT PANNEAU LATERAL DROIT SEITENTEIL RECHTS PANNELLO LATERALE DESTRO PANEL LATERAL DERECHO	55234140
100	CASSETTE FLAP DOOR LEFT VOLET CASSETTE GAUCHE CASSETTENKLAPPE LINKS SPORTELLLO CASSETTA SINISTRO TAPA CASSETTE IZQUIERDO	55234160
110	CASSETTE FLAP DOOR RIGHT VOLET CASSETTE DROIT CASSETTENKLAPPE RECHTS SPORTELLLO CASSETTA DESTRO TAPA CASSETTE DERECHO	55234170
120	TRAY CD VOLET CD CD KLAPPE SPORTELLLO CD TAPA CD	55221430
210	VOLUME KNOB BOUTON VOLUME LAUTSTAERKEKNOPF TASTO VOLUME TECLA VOLUMEN	55221440
300	BUTTON B.BOOST/VOLUME RING BAGUE TOUCHE B.BOOST/VOLUME TASTE B.BOOST/VOLUME RING TASTO B.BOOST/VOLUME ANELLO TECLA B.BOOST/VOLUME ANILLO	55221680
310	CONTROL PANEL TABLEAU DE COMMANDES BEDIENTEIL QUADRO DI COMANDO TABLERO DE MANDO	55234590
320	UPPER FLAP VOLET SUPERIEUR OBEN KLAPPE SPORTELLLO SUPERIORE TAPA SUPERIOR	55221720
330	CASSETTE FLAP DOOR TRIM LEFT ENJOLIVEUR VOLET CASSETTE GAUCHE ZIERRHMEN CASSETTENKLAPPE LINKS FINIZIONE SPORTELLLO CASSETTA SINISTRO EMBELLECEDOR TAPA CASSETTE IZQUIERDO	55234610
340	CASSETTE FLAP DOOR TRIM RIGHT ENJOLIVEUR VOLET CASSETTE DROIT ZIERRHMEN CASSETTENKLAPPE RECHTS FINIZIONE SPORTELLLO CASSETTA DESTRO EMBELLECEDOR TAPA CASSETTE DERECHO	55234600

390	CASSETTE FLAP WINDOW LEFT GLACE VOLET CASSETTE GAUCHE FENSTER CASSETTENKLAPPE LINKS VETRO SPORTELLLO CASSETTA SINISTRO CRISTAL TAPA CASSETTE IZQUIERDO	55221740
400	CASSETTE FLAP WINDOW RIGHT GLACE VOLET CASSETTE DROIT FENSTER CASSETTENKLAPPE RECHTS VETRO SPORTELLLO CASSETTA DESTRO CRISTAL TAPA CASSETTE DERECHA	55221760
410	UPPER FLAP WINDOW GLACE VOLET SUPERIEUR FENSTER OBEN KLAPPE VETRO DEL SPORTELLLO SUPERIORE CRISTAL DEL TAPA SUPERIOR	55234620
420	DISPLAY WINDOW GLACE AFFICHEUR ANZEIGEFENSTER VETRO DEL VISUALIZZATORE CRISTAL DEL VISUALIZADOR	55234640
430	TRAY CD WINDOW GLACE VOLET CD FENSTER CD KLAPPE VETRO DEL SPORTELLLO CD CRISTAL DEL TAPA CD	55234650
550	CASSETTE DOOR DAMPER GEAR ROUE DENTEE PORTE CASSETTE ZAHNRAD CASSETTENHALTER RUOTA DENTATA PORTACASSETTA RUEDA DENTADA PORTACASSETTE	20688960
980	STAND-BY TRANSFORMER TRANSFORMATEUR STAND-BY TRAF0 STAND-BY TRASFORMATORE STAND-BY TRANSFORMADOR DE STAND-BY	55215160
990	SWITCHED MODE POWER TRANSF. TRANSFORMATEUR D'ALIMENTATION TRAF0 SCHALTNETZTEIL TRASFORMATORE DI ALIMENTAZIONE TRANSFORMADOR DE ALIMENTACION	55215940

**CHASSIS AND PRESENTATION 2
CHASSIS ET PRESENTATION 2
CHASSIS UND GEHAEUSETEILE 2
TELAIO E DI PRESENTAZIONE 2
CHASIS Y PRESENTACION 2**

CDM5	5CD MECHANISM ASSY MECANISME 5CD EQUIPE 5CD-WECHSLER K.P.L MECCANISMO 5CD COMPLETO MECANISMO 5CD EQUIPADO	55159380
KDB	DISPLAY/CONTROL BOARD DISPLAY/CONTROL PLATINE DISPLAY/CONTROL PLATTE DISPLAY/CONTROL PIASTRA DISPLAY/CONTROL PLATINA	55193220
080	REAR PANEL PANNEAU ARRIERE SEITENTEIL HINTEN PANNELLO POSTERIORE PANEL POSTERIOR	55234150
090	UPPER CASE ASSY COFFRET SUPERIEUR GEHAEUSE OBEN CASSA SUPERIORE CAJA SUPERIOR	55110500
220	BUTTON STRIP 6 KEYS LEFT BARRETTE DE 6 TOUCHES GAUCHE TASTENLEISTE 6 TASTE LINKS PIATTINA 6 TASTI SINISTRO PLACA DE 6 TECLAS IZQUIERDA	55237450

230	BUTTON STRIP 6 KEYS RIGHT BARRETTE DE 6 TOUCHES DROITE TASTENLEISTE 6 TASTE RECHTS PIATTINA 6 TASTI DESTRO PLACA DE 6 TECLAS DERECHA	55221490
240	BUTTON STRIP DISC CD BARRETTE DE TOUCHES SELECTION DISQUE TASTENLEISTE AUSWAHL LASERPLATTE PIATTINA TASTI SELEZIONE DEL DISCOS PLACA DE TECLAS SELECCION DE DISCOS	55221500
250	BUTTON STRIP ROCK-FLAT-JAZZ BARRETTE TOUCHES 3T ROCK-FLAT-JAZZ TASTENLEISTE ROCK-FLAT-JAZZ PIATTINA TASTI 3T ROCK-FLAT-JAZZ PLACA DE TECLAS 3T ROCK-FLAT-JAZZ	55234540
260	X-SURROUND BUTTON TOUCHE X-SURROUND TASTE X-SURROUND TASTO X-SURROUND TECLA X-SURROUND	55234560
270	B.BOOST BUTTON TOUCHE B.BOOST TASTE B.BOOST TASTO B.BOOST TECLA B.BOOST	55111040
280	TRAY CONTROL BUTTON TOUCHE CDE TIROIR CD CD SCHUBEINHEIT TASTE TASTO COMANDI PORTA-DISCHI TECLA MANDOS PORTADISCO	55221660
290	ON/OFF BUTTON TOUCHE MARCHE/ARRET EIN-AUS TASTE TASTO ACCESO/SPENTO TECLA MARCHA/PARADA	55355090
440	CRYSTAL B.BOOST GLACE B.BOOST FENSTER B.BOOST VETRO B.BOOST CRISTAL B.BOOST	55221650
480	CASSETTE HOLDER LEFT PORTE CASSETTE GAUCHE CASSETTENHALTER LINKS PORTACASSETTA SINISTRO PORTACASSETTE IZQUIERDO	55234660
490	CASSETTE HOLDER RIGHT PORTE CASSETTE DROIT CASSETTENHALTER RECHTS PORTACASSETTA DESTRO PORTACASSETTE DERECHO	55234670
510	SPRING TORSION CASSETTE LEFT RESSORT VOLET CASSETTE GAUCHE NADELFEDER CASSETTENKLAPPELINKS MOLLA PORTACASSETTA SINISTRO RESORTE PORTACASSETTE IZQUIERDO	55113720
520	SPRING TORSION CASSETTE RIGHT RESSORT VOLET CASSETTE DROIT NADELFEDER CASSETTENKLAPPE RECHTS MOLLA PORTACASSETTA DESTRO RESORTE PORTACASSETTE DERECHO	55113730
560	CASSETTE MECHANISM MECANIQUE CASSETTE CASSETTENLAUFWERK MECCANICA CASSETTA MECANISMO CASSETTE	55235110

CD MECHANISM MECANIQUE CD CD MECHANIK MECCANISMO CD MECANICA CD					
03	SPRING RESSORT FEDER MOLLA RESORTE	20979850	17	OPTICAL PLAYER BRACKET SUPPORT LECTEUR OPTIQUE CD-LAUFWERK HALTER SUPPORTO ASSIEME OTTICA SOPORTE MECANISMO OPTICO	20979970
04	GEAR MAIN ROUE DENTEE PRINCIPALE HAUPT-ZAHNRAD RUOTA DENTATA PRINCIPAL RUEDA DENTADA PRINCIPALE	20979800	22	THREADED END-FITTING EMBOUT PLASTIQUE MUFFENTUELLE GHIERA DI PLASTICA CONTERA PLASTICA	20979960
05	GEAR PIVOT ENGRENAGE PIVOT ZAHNRAD DREHPUNKT PIGNONE PERNO PINON PIVOTE	20979830	24	INTERMEDIATE SPINDLE AXE INTERMEDIAIRE ZWISCHENACHSE SPINOTTO INTERMEDIO EJE INTERMEDIO	20979890
06	DUAL GEAR WHEEL DOUBLE ROUE DENTEE DOPPELT ZAHNRAD DOPPIO RUOTA DENTATA DOBLE RUEDA DENTADA	20979760	25	DUAL GEAR WHEEL DOUBLE ROUE DENTEE DOPPELT ZAHNRAD DOPPIO RUOTA DENTATA DOBLE RUEDA DENTADA	20979780
07	SWING ARM BRAS PIVOT ARM,DREHPUNKT BRACCIO PERNO BRAZO PIVOTE	20979940	26	PULLEY POULIE ROLLE PULEGGIA POLEA	20979880
09	GEAR CLUTCH ROUE D'EMBRAYAGE RAD KUPPLUNG RUOTA DI FRIZIONE RUEDA DE EMBRAGUE	20979750	27	RUBBER ROLLER BRACKET SUPPORT GALET CAOUTCHOU GUMMIROLLE HALTER SUPPORTO RULLO DI GOMMA SOPORTE RODILLO DE GOMA	20712170
10	SLIDING ROLLER PATIN GLISSANT RUTSCHIG ROLL PATTINO SCIVOLOSO PATIN RESBALADIZO	20979950	29	SPRING RESSORT SPRUNGFEDER MOLLA MUELLE	21014080
11	GEAR WHEEL ROUE DENTEE ZAHNRAD RUOTA DENTATA RUEDA DENTADA	20979790	30	ARM, PLASTIC BRAS PLASTIQUE ARM, KUNSTSTOFF BRACCIO IN PLASTICA BRAZO PLASTICO	20979980
12	DUAL GEAR DOUBLE ENGRENAGE DOPPELT ZAHNRAD DOPPIO PIGNONE DOBLE PINON	20979770	32	CD LOCK MAGNET VERROU AIMANT CD RIEGEL MAGNET CD CHIUSURA MAGNETE CD CERROJO IMAN CD	55257480
13	INTERMEDIATE GEAR WHEEL POULIE INTERMEDIAIRE DENTEE ZWISCHENZAHNRAD PULEGGIA INTERMEDIA DENTATA POLEA INTERMEDIA DENTADA	20979840	33	TABLE 5 CD PLATEAU 5 CD TELLER 5 CD PIATTO 5 CD PLATO 5 CD	55066450
14	MOTOR PULLEY TRAY/TABLE CD POULIE MOTEUR TIROIR/PLATEAU CD MOTORROLLE SCHUBLADE/TELLER CD PULEGGIA DEL MOTORE CASSETTO/ PIATTO CD POLEA DE MOTOR CORREDERA/ PLATO CD	20979870	34	FF-130SH-14230 MOTOR DC FF-130SH-14230 MOTEUR DC FF-130SH-14230 MOTOR DC FF-130SH-14230 MOTORE DC FF-130SH-14230 MOTOR DC	20581820
15	GUIDE RAIL GUIDE RAIL FUEHRUNGSSCHIENE EINFAEDELN CONTROROTAIA CONTRACARRIL	20979740	35	RF-500TB MOTOR DC RF-500TB MOTEUR DC RF-500TB MOTOR DC RF-500TB MOTORE DC RF-500TB MOTOR DC	20581800
16	MAIN GEAR TORSION SPRING RESSORT A EPINGLE ROUE PRINCIPALE HAUPT-ZAHNRAD NAELFEDER MOLLA DI TORSIONE RUOTA PRINCIPAL RESSORTE HORQUILLA RUEDA PRINCIPALE	20979810	36	RUBBER ROLLER GALET CAOUTCHOU GUMMIROLLE RULLO DI GOMMA RODILLO DE GOMA	20712120
			37	HOLDER MAGNET SUPPORT AIMANT HALTER MAGNET SUPPORTO MAGNETE SOPORTE IMAN	55381040

CHASSIS AND PRESENTATION / CHASSIS ET PRESENTATION / CHASSIS UND GEHAEUSETEILE /
TELAIO E DI PRESENTAZIONE / CHASIS Y PRESENTACION

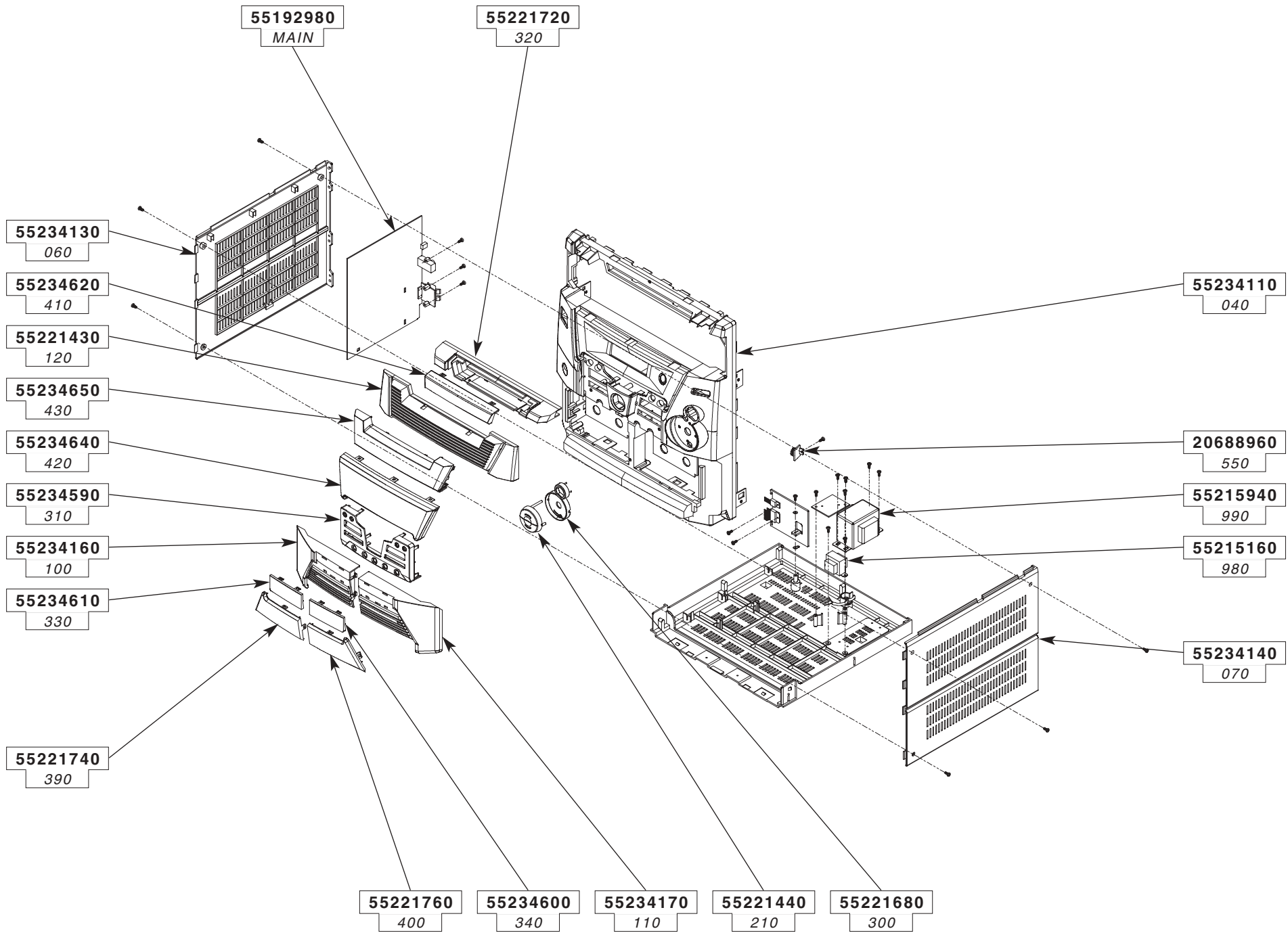

CHASSIS AND PRESENTATION 2 / CHASSIS ET PRESENTATION 2 / CHASSIS UND GEHAEUSETEILE 2 /
TELAIO E DI PRESENTAZIONE 2 / CHASIS Y PRESENTACION 2

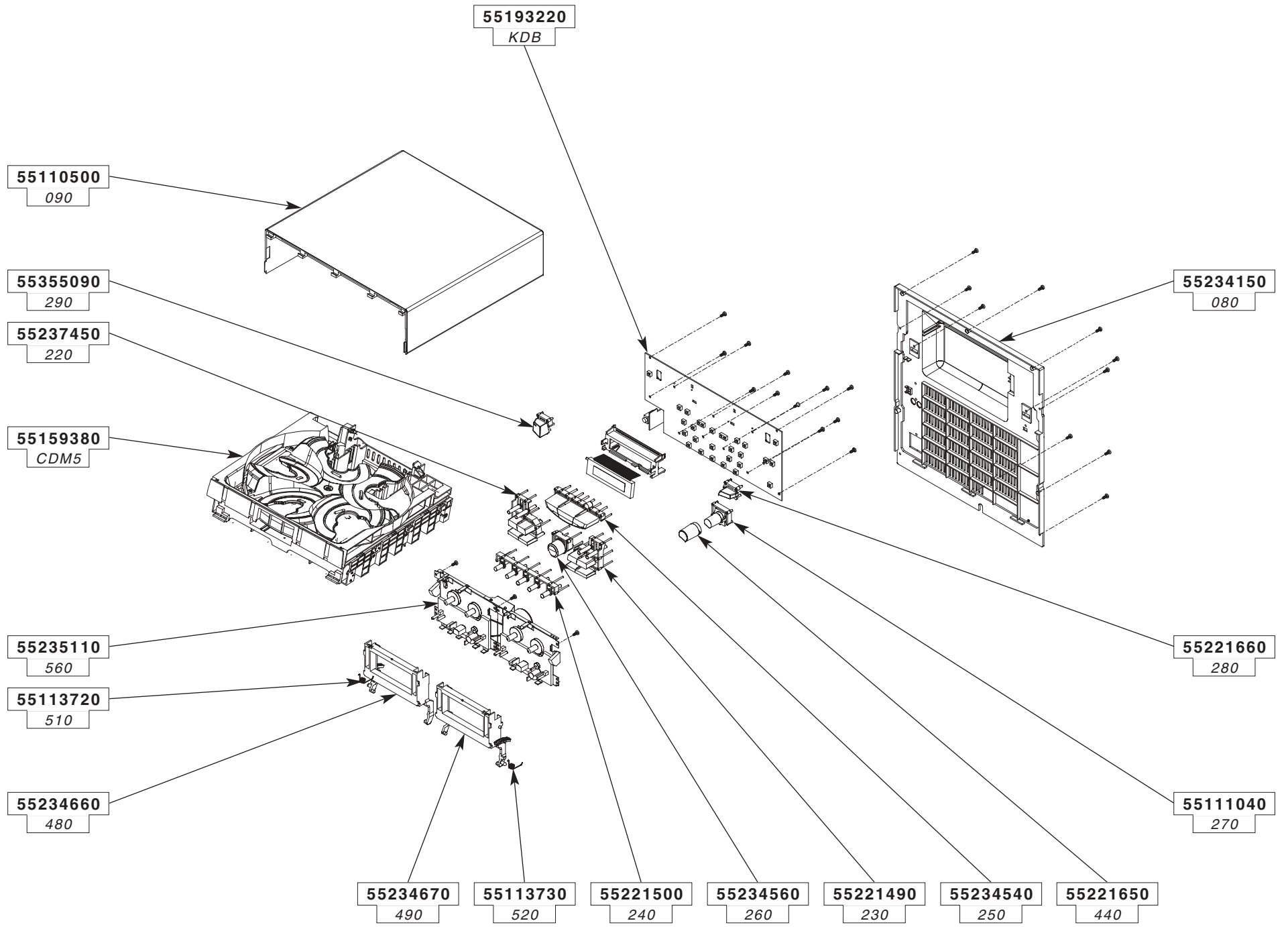

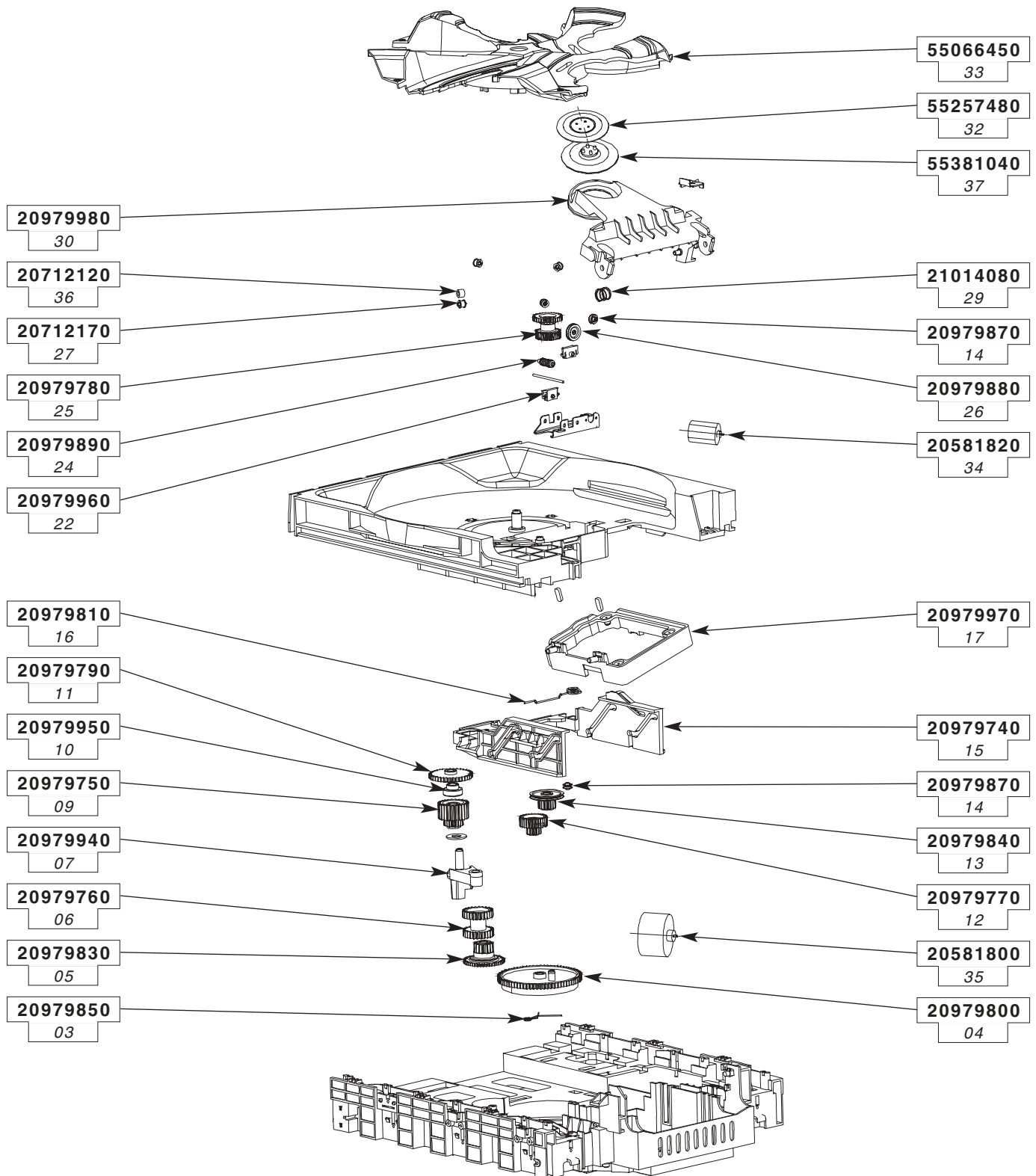

**CD MECHANISM / MECANIQUE CD / CD MECHANIK /
MECCANISMO CD / MECANICA CD**

A3080

7/7

The description and characteristics given here are of informative significance only, and non committal. To keep up the high quality of our products, we reserve the right to make any changes or improvement without previous notice. • Les descriptions et caractéristiques figurant sur ce document sont données à titre d'information et non d'engagement. En effet, soucieux de la qualité de nos produits, nous nous réservons le droit d'effectuer, sans préavis, toute modification ou amélioration. • Die Beschreibungen und Daten in dieser Anleitung dienen nur zur Information und sind nicht bindend. Um die Qualität unserer Produkte ständig zu verbessern, behalten wir uns das Recht auf Änderungen vor. • Le descrizioni e le caratteristiche date su questo documento sono fornite a semplice titolo informativo e senza impegno. Ci riserviamo il diritto di eseguire, senza preavviso, qualsiasi modifica o miglioramento. • Las descripciones y características que figuran en este documento se dan a título de información y no de compromiso. En efecto, en bien de la calidad de nuestros productos, nos reservamos el derecho de efectuar, sin previo aviso, cualquier modificación o mejora.