

IMPORTADOR
COMERCIALIZADORA THOMSON DE MEXICO S.A. DE
C.V
SIERRA CANDELA NO. 111, PISO 11
COL. LOMAS DE CHAPULTEPEC
DEL. MIGUEL HIDALGO
MEXICO D.F. C.P. 11000
R.F.C. CTM-980723 KS5

THOMSON multimedia Inc.
10330 N. Meridian St.
Indianapolis, IN 46290
© 2001 Thomson multimedia Inc.
Trademark(s) © Registered
Marca(s) © Registrada(s)
Marque(s) © Déposée
55135910 (EN/F/E)
www.rca.com



RECA

u
s
e
r
m
a
n
u
a
l

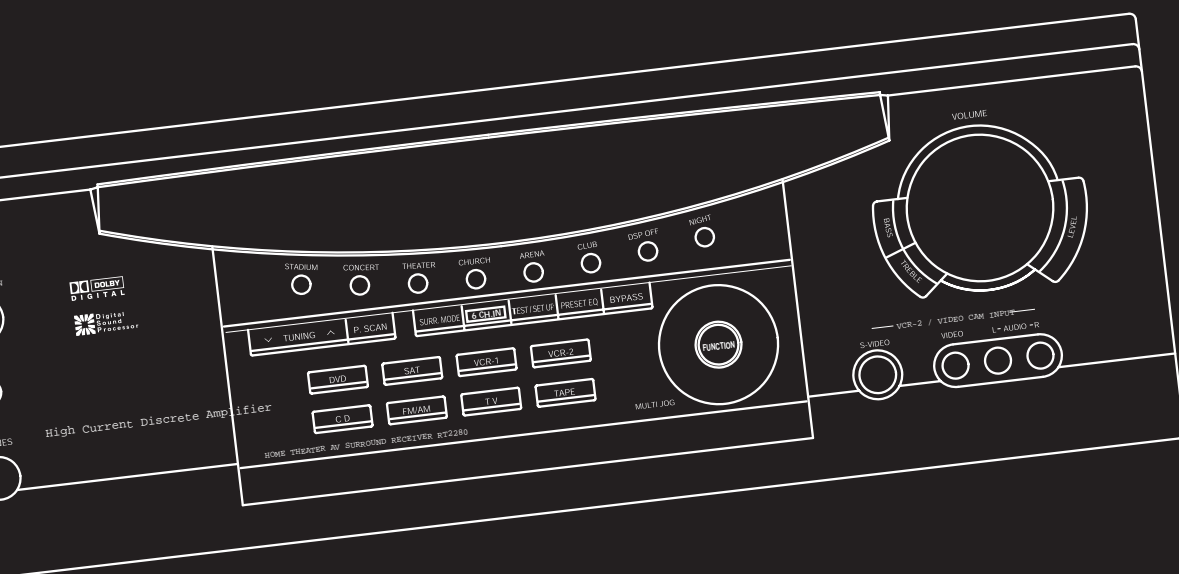

RT2280/RT2250/RT2250R

FCC Information

This device complies with Part 15 of the FCC Rules. Operation is subject to the following two conditions: (1) This device may not cause harmful interference, and (2) this device must accept any interference received, including interference that may cause undesired operation.

In accordance with FCC requirements, changes or modifications not expressly approved by Thomson multimedia Inc. could void the user's authority to operate this product.

This device generates and uses radio frequency (RF) energy, and if not installed and used properly, this equipment may cause interference to radio and television reception.

If this equipment does cause interference to radio or television reception (which you can determine by unplugging the unit), try to correct the interference by one or more of the following measures:

- Re-orient the receiving antenna (that is, the antenna for the radio or television that is "receiving" the interference).
- Move the unit away from the equipment that is receiving interference.
- Plug the unit into a different wall outlet so that the unit and the equipment receiving interference are on different branch circuits.

If these measures do not eliminate the interference, please consult your dealer or an experienced radio/television technician for additional suggestions. Also, the Federal Communications Commission has prepared a helpful booklet, "How To Identify and Resolve Radio TV Interference Problems." This booklet is available from the U.S. Government Printing Office, Washington, DC 20402. Please specify stock number 004-000-00345-4 when ordering copies.

This product complies with DHHS Rules 21 CFR Subchapter J. Applicable at the date of manufacture.

For Your Safety

The AC power plug is polarized (one blade is wider than the other) and only fits into AC power outlets one way. If the plug won't go into the outlet completely, turn the plug over and try to insert it the other way. If it still won't fit, contact a qualified electrician to change the outlet, or use a different one. Do not attempt to bypass this safety feature.

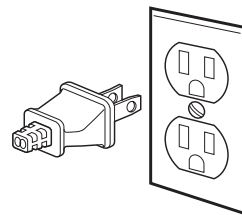

CAUTION: TO PREVENT ELECTRIC SHOCK, MATCH WIDE BLADE OF PLUG TO WIDE SLOT, FULLY INSERT.

For Your Records

In the event that service should be required, you may need both the model number and the serial number. In the space below, record the date and place of purchase, and the serial number:

Model No. _____

Remote Control No. CRK76

Date of Purchase _____

Place of Purchase _____

Service Information

This product should be serviced only by those specially trained in appropriate servicing techniques. For instructions on how to obtain service, refer to the warranty included in this Guide

WARNING: TO PREVENT FIRE OR ELECTRICAL SHOCK HAZARD, DO NOT EXPOSE THIS PRODUCT TO RAIN OR MOISTURE.



 THE LIGHTNING FLASH AND ARROW-HEAD WITHIN THE TRIANGLE IS A WARNING SIGN ALERTING YOU OF "DANGEROUS VOLTAGE" INSIDE THE PRODUCT.	CAUTION RISK OF ELECTRIC SHOCK DO NOT OPEN CAUTION: TO REDUCE THE RISK OF ELECTRIC SHOCK, DO NOT REMOVE COVER (OR BACK). NO USER-SERVICEABLE PARTS INSIDE. REFER SERVICING TO QUALIFIED SERVICE PERSONNEL.	 THE EXCLAMATION POINT WITHIN THE TRIANGLE IS A WARNING SIGN ALERTING YOU OF IMPORTANT INSTRUCTIONS ACCOMPANYING THE PRODUCT.
SEE MARKING ON BOTTOM / BACK OF PRODUCT		

Table of Content

FCC Information

Getting Started

Unpacking the Receiver	.2
Unpacking the Speakers (RT2280 Only)	.3
Inserting Batteries into Remote Control	.3
Set Up and Maintenance of the Receiver	.3
Protect your Components from Overheating	.3
Connecting to Audio-Visual Components	.4
Digital Connection	.5
Connecting Antennas	.5
Connecting the Speakers	.6
Connecting the Subwoofer	.6
Positioning your Speaker	.7
Front Speaker Placement	.7
Surround Placement	.8
Advanced Surround Setting	.8
Test Tone / Channel Balance	.9
Connecting for Power	.9
Using Headphones	.9
Factory Setting	.9

Operating your Receiver

Receiver Controls	.10
Your Remote Control	.11
Display	.12
Switching On/Off	.13
Selection of Audio/Video Source	.13
Using the Remote to Control Additional Components	.14
Using the receiver to play a Source	.15

Advanced Sound Control

Sound Enhancement Systems	.19
Fine Setting of Components	.20
Fine Setting of the Speakers	.21
Advanced Setting	.21

Care and Maintenance

Troubleshooting Tips	.23
Receiver/Tuner Operation	.23
Remote Control Operation	.23
General	.23
Cleaning the Exterior	.23
Equipment Specifications	.23

Remote Codes

Cable Codes	.24
VCR Codes	.24
TV Codes	.25
Satellite Receivers	.26
Audio (RCA only)	.26
Laser disc Players	.26

Limited Warranty (US)27

Limited Warranty (Canada)28

Getting Started

Unpacking the Receiver

You should receive the following items:

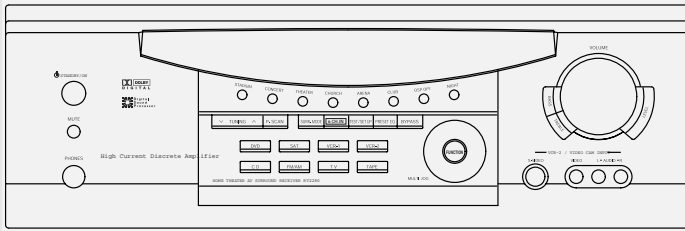

One receiver unit

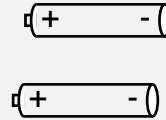

One pair of "AA" batteries

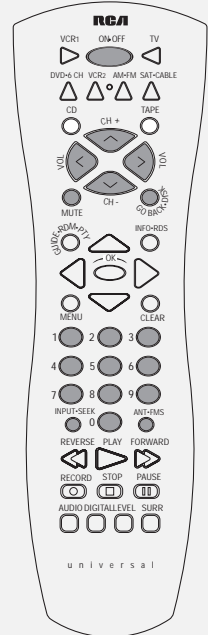

One RCA Universal Remote Control (CRK76)

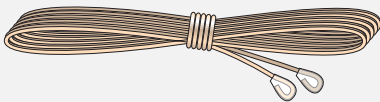

One external FM Dipole antenna

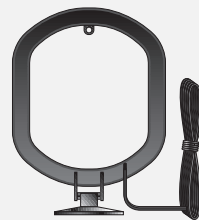

One external AM loop antenna

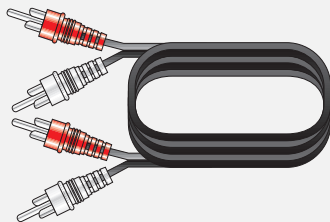

one audio cable (two wires) with red and white RCA connectors;

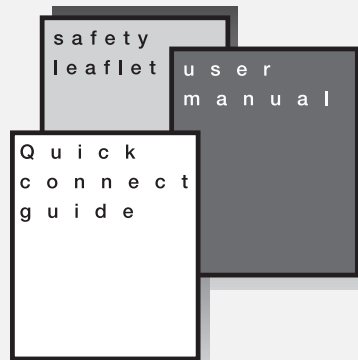

- one instruction book;
- one safety leaflet;
- one Quick Connection Guide

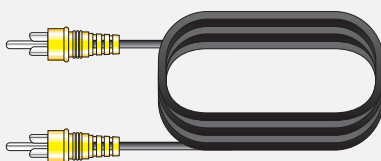

one video cable (single wire) with yellow RCA connectors;

Unpacking The Speakers (RT2280/RT2250 Only)

- one set of speakers including 2 left and right front speakers, 1 centre speaker, 1 subwoofer and 2 left and right rear speakers.

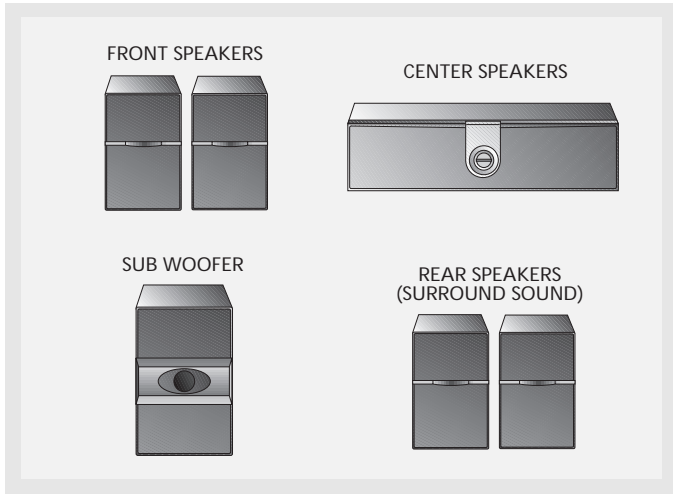

- 6 speaker cables including:

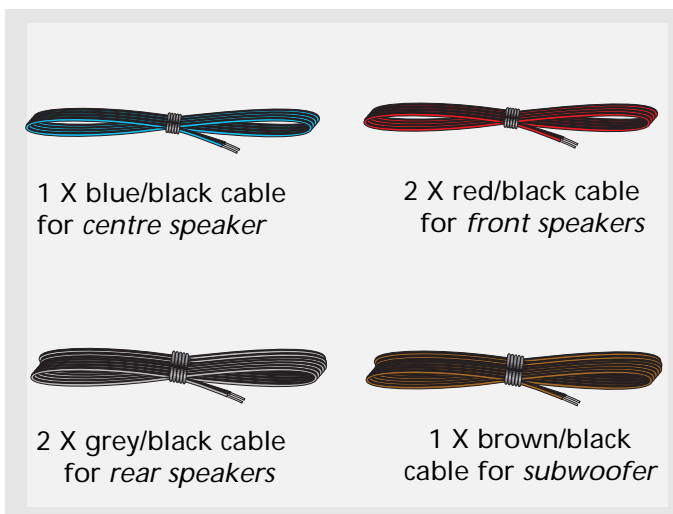

Inserting Batteries into Remote Control

Insert two AA(R6) batteries according to the + and - signs on the battery compartment. To use the remote control, point it directly at your receiver.

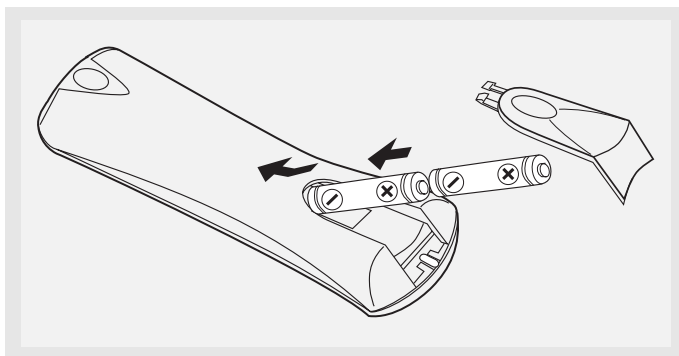

Set up and Maintenance of the Receiver

- Provide spaces for sufficient ventilation as indicated:

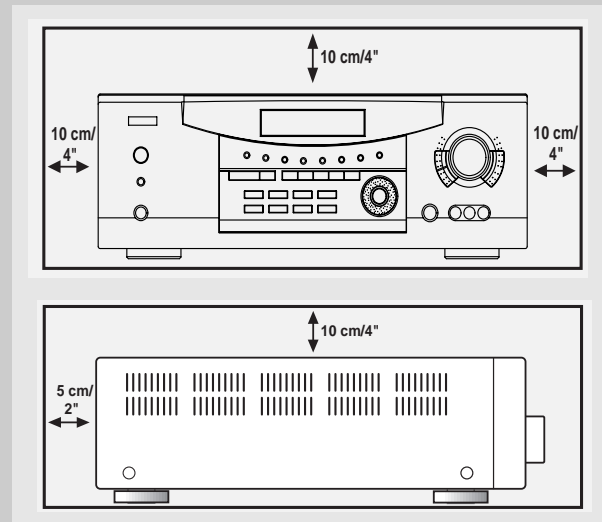

- Do not connect to the AC power cords until all connections are completed.
- Do not use your set immediately after transferring it from a cold place to a warm place: there is risk of condensation.
- Do not expose your set to water and excessively high temperatures.
- After having disconnected your set, clean the case with a soft cloth, or with a slightly damp leather chamois. Never use strong solvents.

Protect your Components from Overheating

- Do not block ventilation holes in any component. Arrange the components so that air can circulate freely.
- Do not stack components directly on top of each other.
- Allow adequate ventilation when placing your components in a stand.
- Place an amplifier near the top shelf of the stand so heated air rising from it will not affect other components. If you have a satellite receiver, you should place it on the top shelf.

Getting Started

Connecting to Audio-Visual Components

S-VIDEO

If your video component has a S-Video jack included, you can make use of it to enjoy enhanced video quality by connecting it to the relevant S-Video jack at the rear side of the receiver. One video cable is needed for each component. When S-Video cable is used, composite video (yellow RCA connector) cable must also be connected for VCR recording. Note: Before plugging in the optical cable or S-Video cable, make sure to match the shape of the plug and jack, otherwise, you will not be able to plug in completely.

DIGITAL CONNECTION

If you have a SAT receiver DVD player or CD player with a digital output, you can make use of an optical digital connecting cord (not supplied) or coaxial digital connecting cord (not supplied) to carry the audio portion of the signal and enjoy Dolby Digital sound quality. One optical or coaxial cable is needed for each SAT receiver, DVD player or CD player. When optical or coaxial cable is used, the analog audio cables are still needed if recording through a tape or VCR is desired. This receiver provides one optical and one coaxial digital input for the connection of your components. Please connect your components (e.g. DVD, SAT or CD) to the appropriate digital inputs and press FUNCTION and then rotate MULTIJOG to match your connection.

Note: Optical and coax cables carry only the audio portion of the signal. A video connection must also be established for a SAT receiver and DVD player. S-video provides the best connection for the video portion of the signal. Composite video (yellow RCA connector) can also be used. It is important that the same type of cable (S-video or composite) that is connected from the Home Theater to the TV is used to connect the SAT receiver or DVD player to the Home Theater.

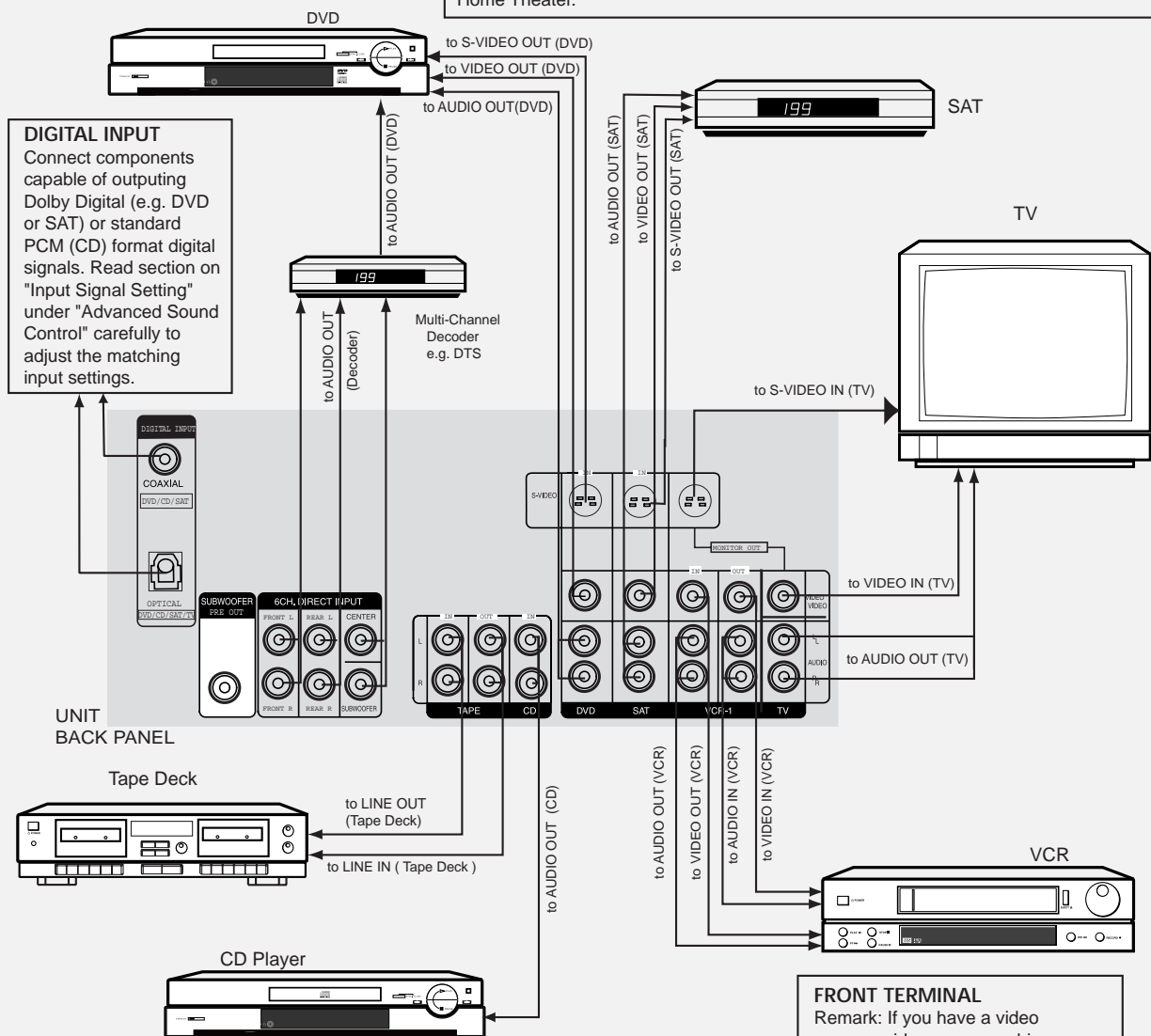

DIGITAL INPUT
Connect components capable of outputting Dolby Digital (e.g. DVD or SAT) or standard PCM (CD) format digital signals. Read section on "Input Signal Setting" under "Advanced Sound Control" carefully to adjust the matching input settings.

If your CD player is equipped with digital optical jacks, use of optical cable is preferred. What you need is just one more optical digital connecting cord(not supplied). Plug it in the digital input jack of the receiver and select OPTICAL on the receiver setting (see details on pg 20 chapter "Input Signal Setting"). You can enjoy better sound quality brought to you by the optical cable. When optical cable is used, analog cables are still needed for recording to tape output. Note: This receiver has one digital optical jack only. Be sure that such connection does not prevent optical cable connection of other components (e.g. DVD & SAT)

FRONT TERMINAL
Remark: If you have a video camera, video game machine, or an extra VCR, connect it to VCR 2 jack at the front of the receiver

Digital Connections

Read instructions carefully when connecting components to the receiver.

Digital In Jacks can accept Dolby Digital (AC-3), or PCM signals when compatible components are connected.

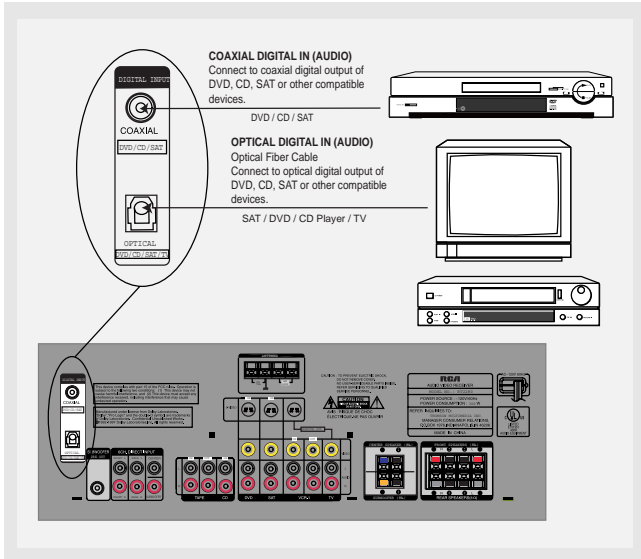

AM Loop Antenna and FM Indoor Antenna

1. Uncoil the Antenna wire and located the base end
2. Press down on the Antenna tab to open the terminal

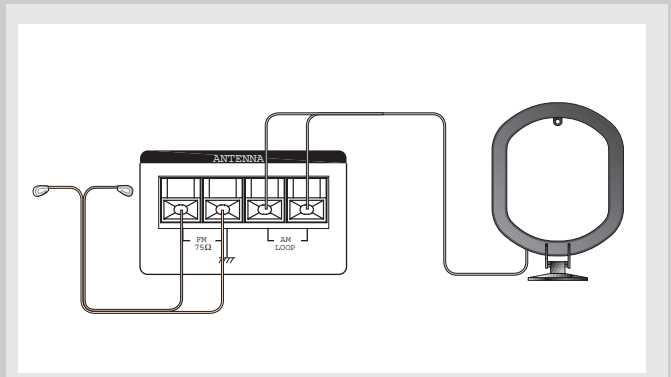

AM Loop Antenna

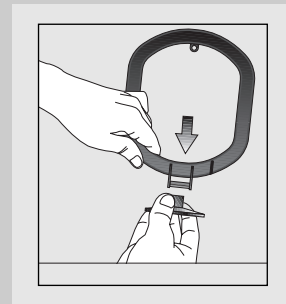

Connecting the Antennas

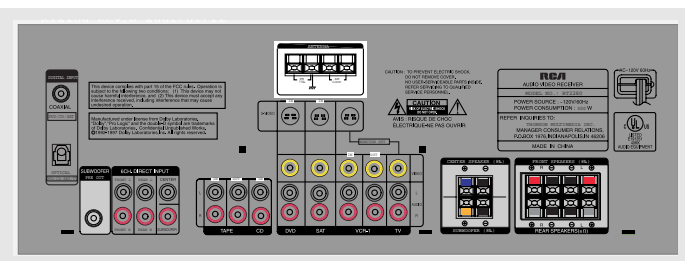

The AM and FM antennas connect to the AM and FM terminals on the system's back panel.

They must be hooked up in order to receive clear reception.

HINT

- For FM reception, extend antenna to its full length and arrange the Antenna as a T Shape
- For AM reception, rotate the antenna horizontally to get better reception.

Antenna and Speaker Wire Connection

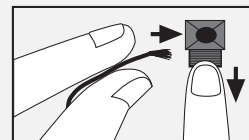

Push Speaker terminal tab down to insert wire.

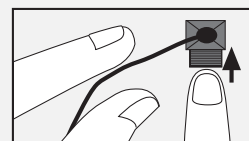

Release tab to lock wire in the terminal.

NOTE: Make sure the insulation is completely removed from the ends of the Antenna and speaker wires at all connection points.

Getting Started

Connecting the Speakers

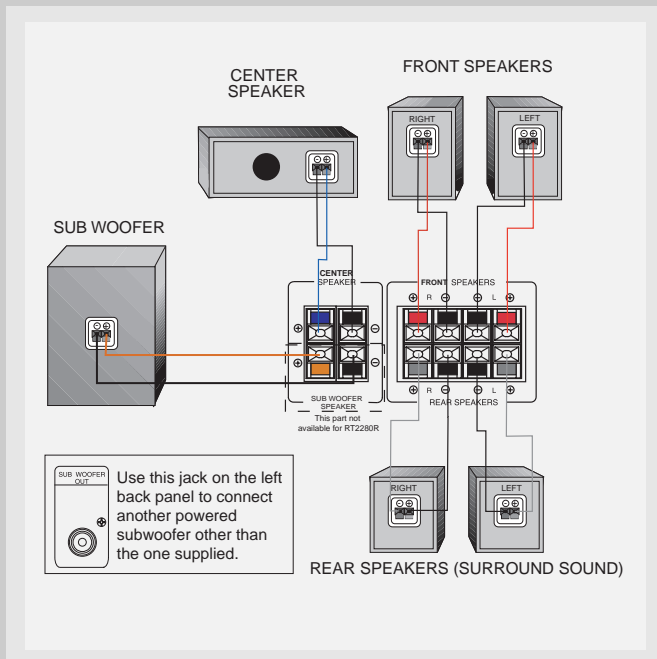

Speakers

There are 6 speakers equipped with the unit (2 front, 1 center, 2 rear, 1 subwoofer). In order to enjoy good surround effects all six speakers need to be connected to the receiver

At least two front speakers (left and right) are required. For better sound quality, Center speaker, rear speakers and Subwoofer should also be connected. Adding center and rear speakers will enhance surround effects. Adding a Subwoofer will increase bass response.

If you want to enjoy full range of sound effects, with small speakers, it is a must to use the subwoofer with the speakers to maintain adequate bass signal.

Speaker cords

1 for each speaker, is needed for connection. Twist the stripped ends of speaker cord about 2/3 inch (15 mm). Press down on the tab to open the terminal and insert the wire. Snap the tab closed.

Antenna and Speaker Wire Connection

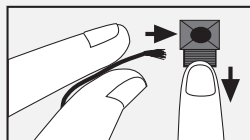

Push Speaker terminal tab down to insert wire.

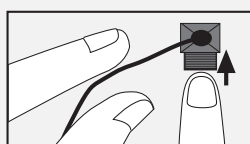

Release tab to lock wire in the terminal.

NOTE: Make sure the insulation is completely removed from the ends of the Antenna and speaker wires at all connection points.

To ease speaker connections, the speaker cords and the terminals are color-coded.

- Red/Black (Front Speakers),
- Blue/Black (Center Speaker)
- Grey/Black (Rear Speakers).
- Brown/Black (Subwoofer)

Connect the L, R speaker (with red/black terminal) on the back of the speakers to the corresponding color on the receiver. Do the same for center (with blue/black terminal), rear speaker (with grey/black terminal) and the subwoofer (with brown/black terminal).

Speaker Polarity

When connecting the speakers, make sure the polarities ("+" speaker wire to "+" on the receiver) of speaker wires and terminals are matched. If the cords are reversed, the sound will be distorted and will lack bass ("out of phase" effect).

Connecting the Subwoofer

For RT2280/RT2250, connect the subwoofer with the speaker cord (brown/ black) provided. For RT2250R, or if you want to connect your own powered subwoofer, a mono aural audio cord (not supplied) is needed (RCA terminal).

This receiver offers a high flexibility for user to use a large variety of speakers and subwoofers. For more information please refer to section "Fine Setting of the Speakers" in "Advanced Sound Control" on page 21.

Positioning your speaker

① Left, Right (Front Speakers)

They carry primarily music and sound effects

② Center

In surround mode, the center speaker carries much of the dialogue as well as music and effects. It should be set between the left and right speakers.

③ Surround (Rear Speakers)

Their overall sound balance should be as close as possible to the front speakers. Proper placement is vital to establish an evenly distributed sound field.

Subwoofer

A subwoofer is designed to reproduce powerful low bass effects (explosions, the rumble of spaceships, etc.) which dramatically heightens involvement with the action on the screen. It is therefore recommended to connect subwoofers when small speakers are used.

Magnetic shielding

Speakers placed less than two feet from the TV set must be magnetically shielded in order to prevent picture distortion. Front and center speakers provided with RT2280/RT2250 are magnetically shielded to protect your TV set.

It is not recommended to place the rear speakers near the TV set.

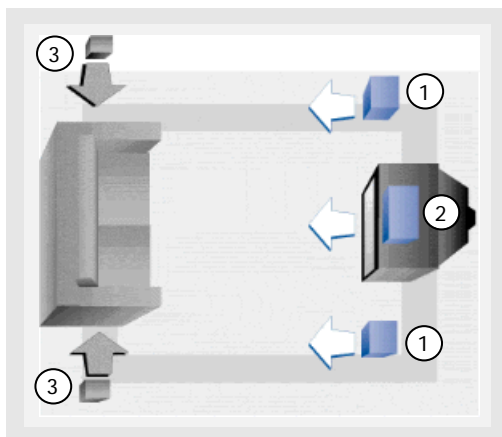

Courtesy Dolby Laboratories

Front Speaker Placement

Even if you can't duplicate this ideal home theater setup exactly, the suggestions for speaker placement that follow will help you get good results.

Alignment

Align the center speaker evenly with (A), or slightly behind (B), the left and right speakers, but not ahead of them.

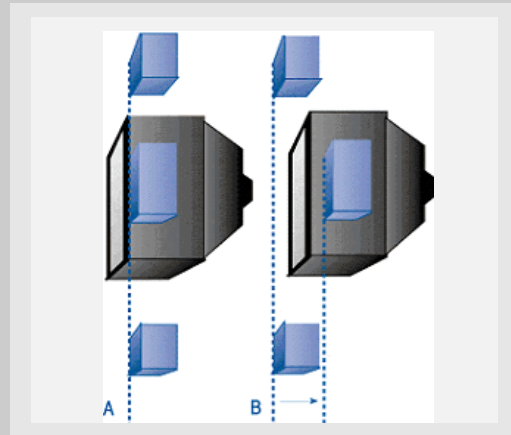

Courtesy Dolby Laboratories

Advanced Setting

Angle

Placing the left and right speakers to form a 45-degree angle with your favorite viewing position will duplicate the soundtrack mixer's perspective.

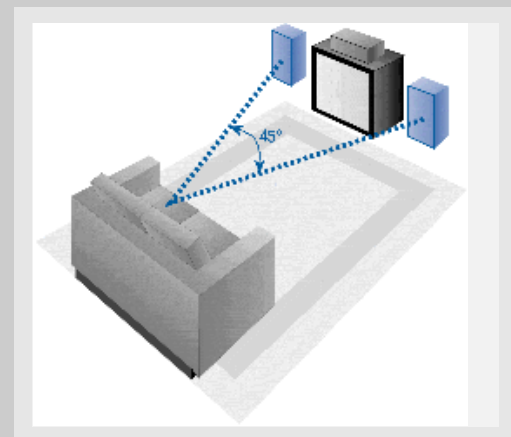

Courtesy Dolby Laboratories

Height

The mid- and high-frequency drivers of the three front speakers should be as close as possible to the same height. This often requires placing the center speaker directly atop (A) or beneath (B) the TV set.

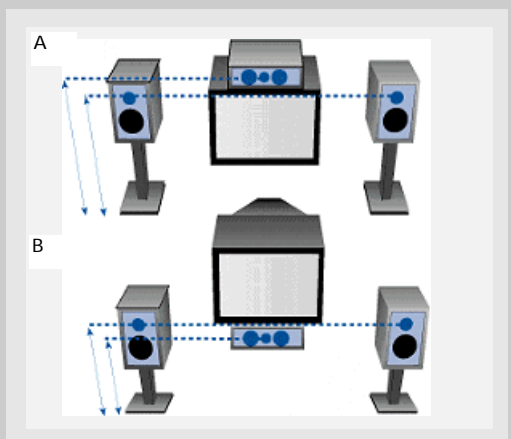

Courtesy Dolby Laboratories

Getting Started

Preferred surround placement

Location

If possible, place surround speakers to either side of the listening area, not behind it.

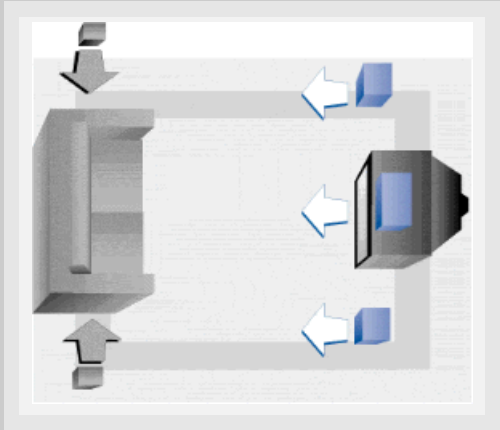

Courtesy Dolby Laboratories

Height

If space permits, install surrounds 2-3 feet above viewers. This helps to minimize localization effects.

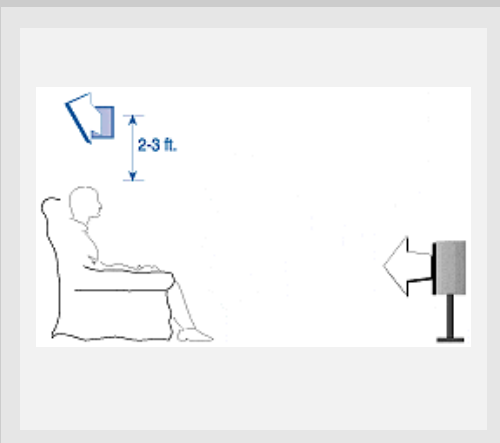

Courtesy Dolby Laboratories

Aiming

Aiming surrounds straight across the room, not down at viewers, helps create a more open, spacious surround sound field.

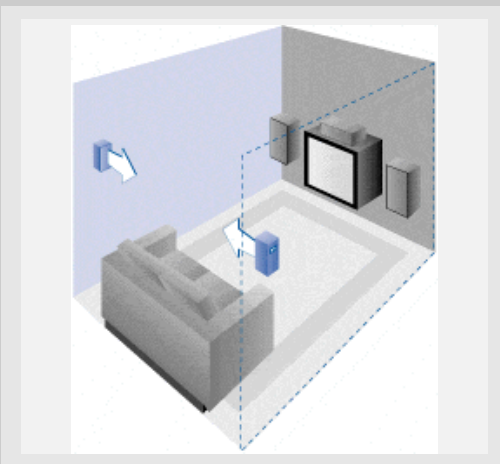

Courtesy Dolby Laboratories

Advanced Setting

Alternative Surround Placement

Rear wall

If rear wall mounting is the only choice, aim the speakers at each other (A), towards the front (B) or even towards the sidewalls (C, D). Experiment with placement until surround sounds seem to envelop you, rather than coming from behind you.

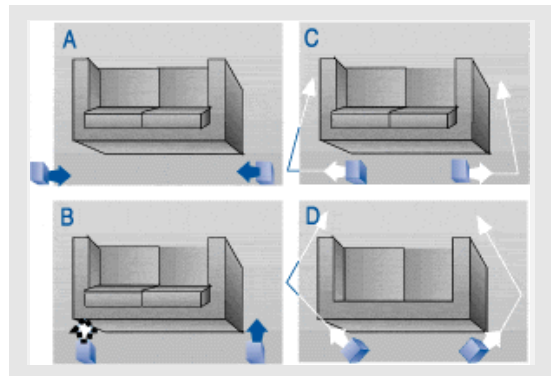

Courtesy Dolby Laboratories

No adjacent walls

Surrounds can go on stands facing each other to approximate the preferred sidewall mounting (A), or to the sides or rear of the viewing area aimed upwards. In the latter case, they can go right on the floor, or preferably, a few feet off the floor such as on end tables (B).

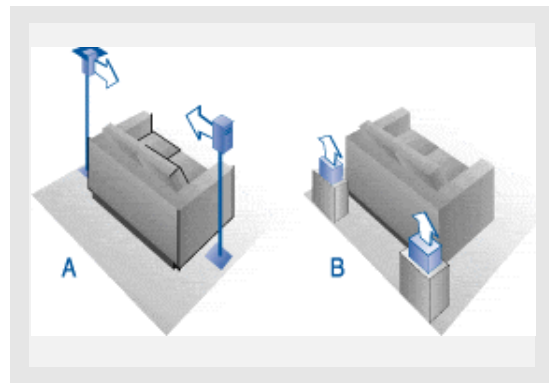

Courtesy Dolby Laboratories

Test Tone / Channel balance

Channel balance

Your receiver is equipped with a test signal generator for balancing the channels. As the signal "travels" from channel to channel, adjust the level controls until each channel plays at the same loudness level. (details see operation of test/setup)

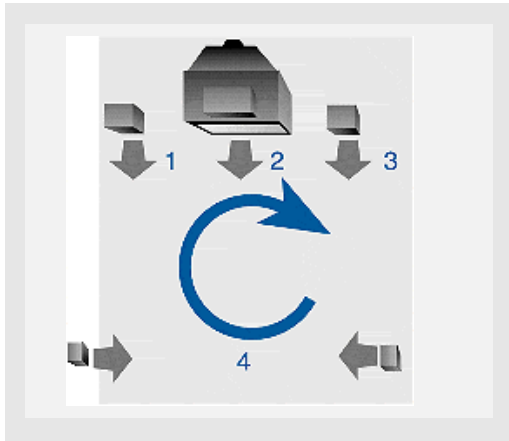

Courtesy Dolby Laboratories

Level adjustment & surround channel level expectation

Even though you adjust the surround channel to be as loud as the others on the test signal, you'll find that on actual program material the surround channel is usually much lower than the front. Don't be tempted to readjust the surround level; program producers use surround mostly for subtle atmosphere and ambience, and only rarely for special effects. A good surround mix doesn't call attention to itself; if it did, it would soon become distracting.

NOTE

The system is equipped with Dolby Digital, and manufactured under License from Dolby Laboratories.



Dolby Digital
Manufactured under
license from Dolby
Laboratories. "Dolby",
"Pro Logic" and the double-D symbol are trademarks of Dolby Laboratories. Copyright 1992-1997 Dolby Laboratories, Inc. All Rights Reserved.

Connecting for Power

Make sure you connect all your other electronic components and the speakers before plugging your receiver into the outlet. Plug the power cord in the wall outlet, matching the wide blade of the plug with the wide slot in the outlet. Be sure to insert the plug completely.

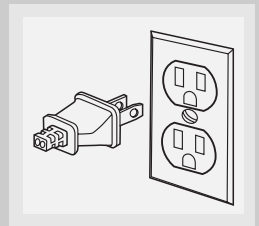

Using Headphones

To listen privately through your audio system, use the PHONES jack on the receiver. However, make sure you turn down the volume before you put on the headphones. Increase the volume to the desired level after headphones are in place.

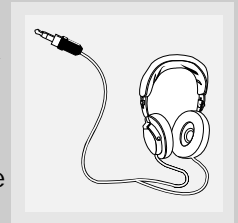

Once headphones are connected, "HEADPHONE DOWNMIX 2 CHANNEL" will scroll on display. This feature automatically converts multi-channel speaker outputs to 2 channel stereo for your listening pleasure.

Hearing Comfort & Well-Being

- Do not play your headset at a high volume. Hearing experts advise against continuous extended play.
- If you experience a ringing in your ears, reduce volume or discontinue use.

Factory Setting

The RT2280/RT2250 is preset to the following setting when you first time turn on the power
Function = Tuner
Surround mode = Stereo (Left + Right (small) + sub-woofer on)
Volume setting = 25 dB
Bass & treble = 0 dB

Restore to Factory Settings

You can always restore all settings back to its original state. When the receiver is in STANDBY mode, press accordingly to restore all settings back to factory default :
STADIUM → NIGHT → DSP OFF → CLUB

NOTE

All preset radio stations and surround sound setting will be lost after factory setting is restored.

Operating Your Receiver

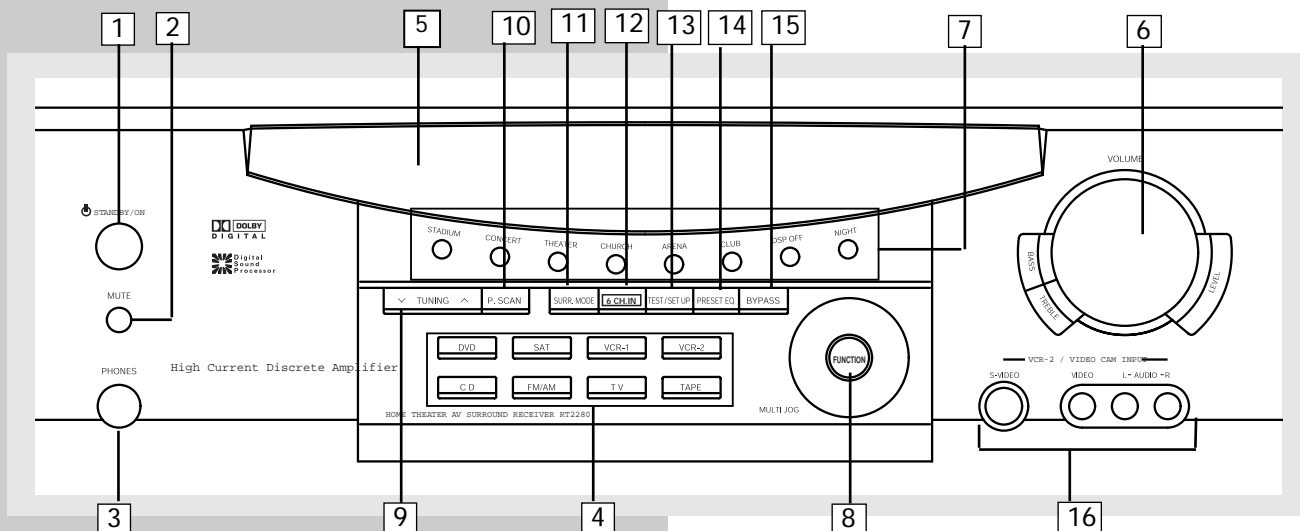

Receiver Controls

1. STANDBY/ON

To turn the unit on/ off. When the system is turned on, the unit will go to the mode it was in before power off.

2. MUTE

To mute all audio outputs.

3. PHONES

Plug your headphones (not supplied) into it for your private enjoyment. Speakers will be off when phones are inserted.

4. Source Buttons

To select sound source. For example, CD, SAT etc.

5. Display

To display current status of the receiver.

6. Sound Control

Let you adjust the sound – volume, treble, bass & balance.

- To change the VOLUME, turn the large central knob.
- To adjust TREBLE or BASS, press relevant button and turn the knob.
- To change the volume of individual speaker, press LEVEL button repeatedly to select the speaker, then turn the knob to adjust the level. (refer to “The TEST/ SET UP button” on page 21)

7. DSP (Digital Sound Processor) & NIGHT mode

Press corresponding button to select the DSP mode (STADIUM/ CONCERT/ THEATER/ ARENA/ CHURCH/ CLUB/ OFF) you want.

Press NIGHT for your enjoyment at night (see page 20).

8. MULTI JOG, FUNCTION

When pressing FUNCTION repeatedly, the display will toggle among Audio Source (for DVD, SAT & CD), SLEEP mode and DIM selection.

Please refer to page 20 for “Input Signal Setting”.

- In SLEEP mode, you can set the receiver to turn off after 30, 60, 90 or 120 minutes.

- In DIM selection, you can rotate to set the brightness of the display. Such setting will be stored.
- Use MULTI JOG for speakers and sub-woofers setup and pre-set radio stations selection.

9. TUNING

Press for about 2 seconds to activate Automatic Preset function. Press once to review all preset stations.

10. P. SCAN (Preset Scan)

- Press and hold for about 2 seconds to start the automatic tuner station preset.
- Press to view preset stations one by one.

11. SURR. MODE

Press repeatedly to select the surround mode you want. (refer to “Advanced Sound Control” on page 20.)

12. 6 CH (6 Channels External Input)

Press to select the input connected to an external 6-Channel decoder. Press again to return to the most recently selected source mode. (see 6 Channel External Input on page 11).

13. TEST/ SET UP

When pressing it briefly, a short noise (test tone) will be generated in the speakers one by one so that you can adjust the volume of individual speaker. When keep pressing for two seconds, it will enter setup mode for speakers and subwoofers. Rotate the MULTI JOG to choose the options. (refer to “The TEST/ SET UP button” on page 21.)

14. PRESET EQ

Press repeatedly to select the desirable EQ mode (music style) – CLASSIC, POP, ROCK, JAZZ, VOCAL or FLAT. Your choice will be saved automatically.

15. BYPASS

Press to go back to stereo sound (no DSP effect, no sound from center and surround speakers)

16. VCR2/Video Cam Input

For convenient use of your digital camera, family game machines, second VCR, etc.

Your Remote Control

Please be sure you have inserted the batteries into the remote control (see relevant section on page 3.) You can test it by pressing any button. If it works, the red LED will light.

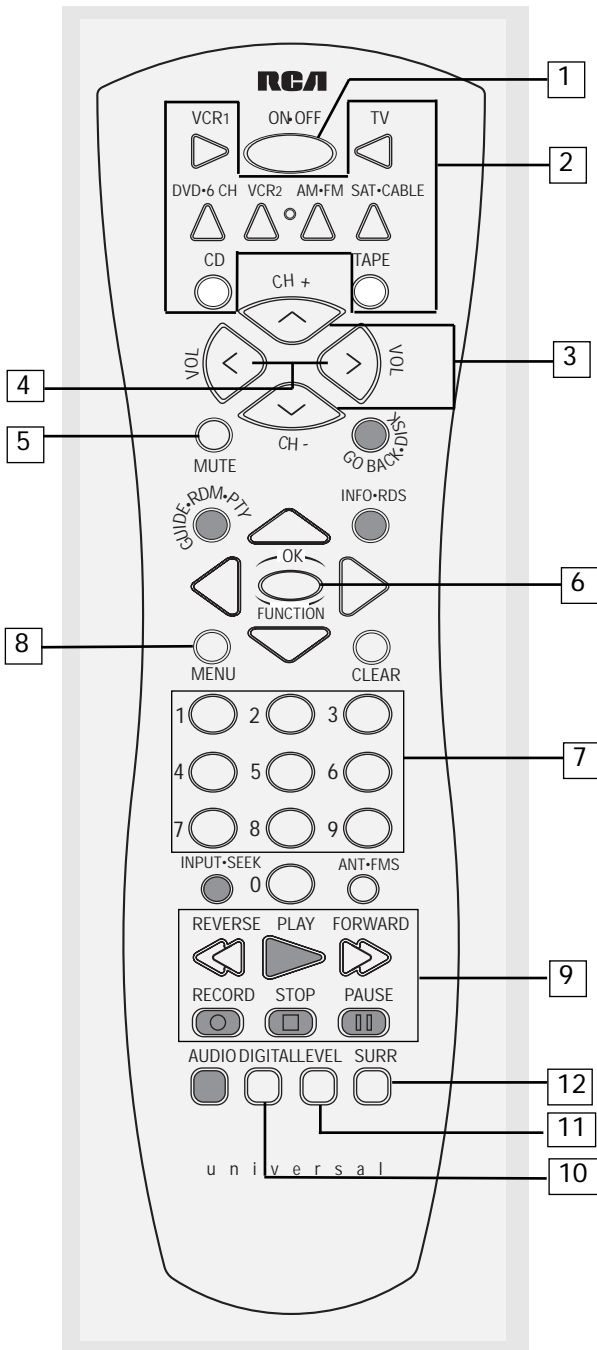

NOTE

The remote buttons GO BACK•DISK, GUIDE•RDM•PTY, INFO•RDS, INPUT•SEEK & AUDIO do not work in tuner mode.

1. ON/OFF

To turn on or off the receiver and other auxiliary components (see page 14 "Using the Remote to Control Additional Components").

2. Source Buttons

To turn on and select various audio/ video sources. You can also enter the 6 Channels direct input mode by pressing DVD•6CH.

3. CH+, CH- (Channel Buttons)

To select programmed stations (in TUNER mode).

4. VOL (Volume Buttons)

To adjust the volume.

5. MUTE

To mute all audio outputs.

6. Adjustment Buttons

Press AUDIO button to activate the control, then upon pressing OK/FUNCTION, the display will toggle among:

- Preset EQ (Stereo only),
- SLEEP Mode
- DIM Mode.

When the display shows the setup you want to change, press the left and right arrow buttons beside OK button to make changes, then press OK to finalize your choice.

7. Number Buttons

To access directly a pre-set station or to peripheral devices (in TUNER mode).

8. MENU (Tuner Mode only)

- Press AM/FM
- Press to store desired frequency in memory. The flashing word MEMORY in red will appear in display. Input your desired channel number while the word is still flashing and the frequency will be stored. (For details, refer to "Storing and Recalling Stations in Memory" on page 10.)

9. Operation Buttons

In TUNER mode, press AM/FM on the remote.

- Press REVERSE and FORWARD keys to tune down or up the radio frequency.
- PLAY, RECORD, STOP and PAUSE keys are only for easy control of external devices that are connected to your receiver such as CD, TV, DVD, TAPE, etc.. The remote control currently operates most Thomson, RCA and GE products, but it can be programmed to operate devices from other manufacturers (For details, refer to "Using the Remote to Control Additional Components" on page 14.)

10. DIGITAL

Select the way your audio/video components are connected to the receiver (Analog, Optical, Coaxial or Input/Output).

11. LEVEL

Press to adjust the volume of individual speaker. Press repeatedly and the display will toggle among different channels (Left front speaker, Right front speaker, Center speaker, Left rear speaker, Right rear speaker, and Subwoofer). Press the left and right arrow buttons beside OK button for adjustment.

12. SURR (Surround Sound Control)

Press to change the surround sound settings. The display will toggle among DOLBY DIGITAL, DOLBY PRO LOGIC, DOLBY 3 STEREO, STEREO and DSP modes.

(For details, refer to section "Advanced Sound Control" on page 19.)

Operating Your Receiver

Display



Digital

- Audio output is in Dolby Digital mode.

Pro Logic

- Audio output is in Dolby ProLogic mode.

3 Stereo

- Audio output is in 3 Stereo mode.

ST

- Tuner stereo signal detected.

TUNED

- Tuner station detected.

DSP

- Unit is in DSP (Digital Sound Processing) mode.

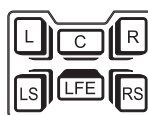

- Speaker Icons.

SLEEP

- Unit in Sleep mode.

MEMORY

- Unit in Memory mode.

KHz

MHz

- Tuner frequency unit.

Switching on /off

- To switch on the receiver, press **STANDBY/ON** button (1) once. Alternatively, you can press any of the source buttons to power on the receiver.

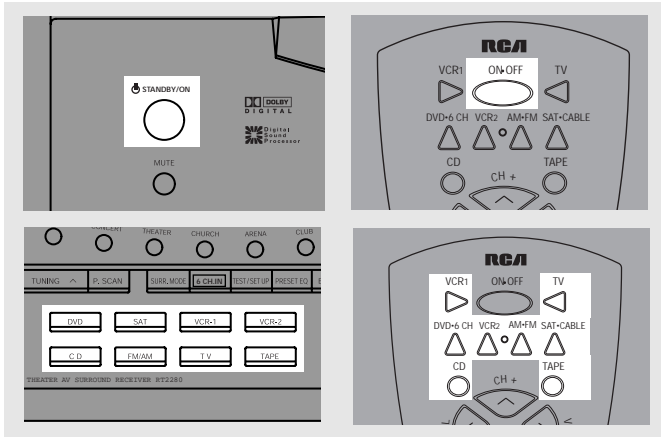

- Standby: when the receiver is on, press the **STANDBY/ON** button once to activate the standby mode.
- To switch off the unit completely, unplug the power cord from the socket

NOTE

Your receiver has a back up memory to keep your settings like preset radio station for about 2 weeks in case electricity cut occurs. If the receiver is unplugged for more than 2 weeks, all the settings will be lost and re-setting will be necessary.

Selection of Audio/Video source

When one of the source button is pressed, the audio and video input corresponding to the name will be activated.

The receiver acts as a switching device between all the sources that are plugged into to it.

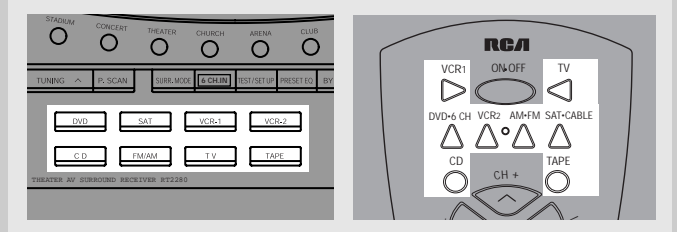

Example 1:

If you connect a DVD player to the DVD input (audio + video) on the receiver and press the **DVD** button, you will be able to have the sound and image transmitted by the DVD.

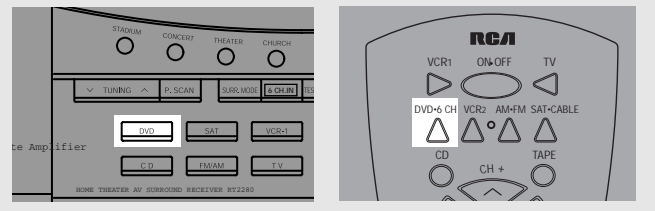

Example 2:

Based on the example 1, the DVD is playing, if a VCR is connected to the VCR 1 input (audio + video) of the receiver and the **VCR1** button is pressed, image and sound from the VCR source will replace the DVD.

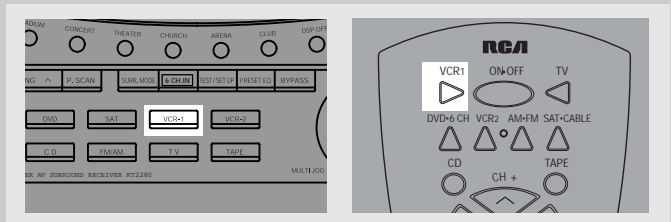

Operating your Receiver

You can connect up to 7 audio/video sources to this amplifier:

Source button (receiver front panel)	Corresponding connector (receiver back panel)
- DVD	DVD IN (audio / video)
- SAT	SAT IN (audio / video)
- VCR-1	VCR-1 IN (audio / video)
- VCR-2	VCR 2 IN (audio / video)
- CD	CD IN (audio only)
- TV	TV IN (audio only)
- TAPE	TAPE IN (audio only)
- FM/AM	built-in

When a source is selected, the source name will be shown on the display.

Example: Press **DVD** to select DVD as the source to the amplifier.

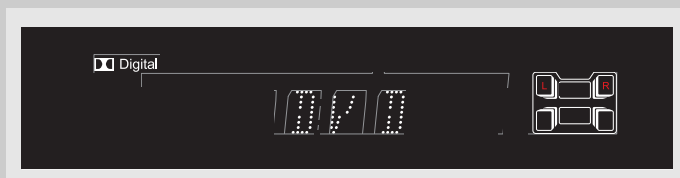

NOTE

1. Your receiver has a built in tuner. Just connect the appropriate antenna on the back of the receiver and you will be able to listen to radio stations. (See details in Tuner section)
2. Other sources can be connected to the above standard source. Example: you can connect a LD into the DVD inputs.
3. Refer to the "Connecting To Audio-Visual Components" section for details on connection.

Using the Remote to Control Additional Components

You can set your remote to control other components (like CD, TV, DVD, TAPE, etc.). What you need is to encode them in advance (not necessary for recent RCA & Proscan models).

1. Turn on the component to be programmed.
2. Look up the brand and corresponding code number in the code list from page 24 to 26.
3. Press and hold the corresponding Source Button (like **VCR1**, **VCR2**, **TV**, **DVD**) on the remote while entering the code from the code list using the Number Buttons.

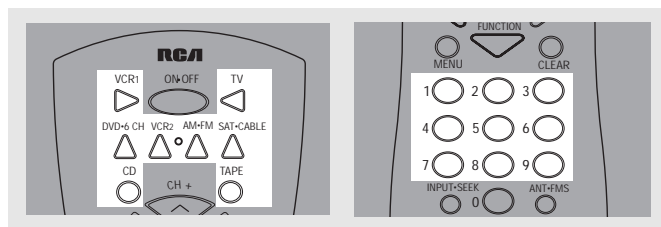

4. Release the component button, then press **ON-OFF** to see if the component will be turned off.

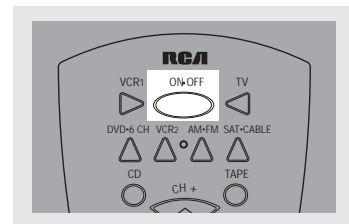

5. If this does not work, repeat steps 3 and 4 by trying to use the next code (if available) listed for the brand of your component until the component responds to the remote command.

NOTE

Once your remote is encoded, you can press ON/OFF on the remote once to turn off the component and then followed by the second time quickly to turn off the receiver (i.e. this unit). If you only want the receiver to be turned off, select FM/AM while the unit is ON before pressing ON/OFF.

HINT

This remote may not operate all models of the brands shown.

If batteries are removed from the battery compartment of the remote control, all memory will be lost. You need to re-enter all previously programmed codes again.

The buttons on the remote may not work correspondingly with those on other brand components. Experiment with the remote and your components to see which buttons work. If only a few functions operate, check to see if another code set will work with more buttons.

Using the receiver to play a source

After having properly connected a source (DVD, CD, VCR) to the receiver, you can partly control them through the receiver.

Playing a DVD with the receiver

1. Connect a DVD player to the receiver (see connecting your receiver for details)

NOTE

To play Dolby Digital sound, the source must be connected to the receiver via the optical or coaxial terminal (see "Digital Connection" on page 5 for details)

2. Press **STANDBY/ON** to switch on the receiver
3. Select the DVD source by pressing the **DVD** source button

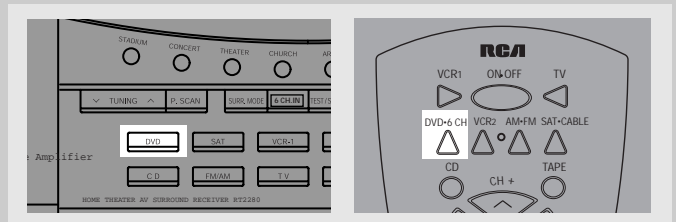

4. Switch ON the DVD player and start playback
5. Switch ON your TV
6. Select the appropriate A/V channel on the TV (refer to your TV manual for details) until the image from the DVD player is displayed
7. Set the sound Mode if needed (see "Advanced sound control" for details)

Example 1:

To play 5.1 Dolby Digital surround sound
Press **SURR. MODE** button until "Dolby Digital" appears on the Display and all of the speakers' icons light up.

Example 2:

DVD: You may also need to select the Dolby Digital 5.1 on the DVD disc menu to have the digital surround enabled providing that the disc is encoded with Dolby Digital 5.1 (please refer to the DVD player and DVD disc instruction)

Operating your Receiver

Example 3:

LD: You may need to select a different Audio Channel on your LD (refer to your LD player manual)

8. Adjust volume knob accordingly

Operating the Radio

The receiver has a built-in tuner that allows for AM/FM radio function.

Manual tuning

1. Connect the FM and AM antenna accordingly (see "Connecting the Antenna" on page 5 section for details)

2. Press **STANDBY/ON** to switch on the receiver.

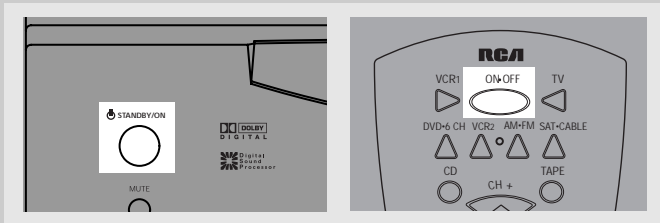

3. Press **AM/FM** and "TUNER" will flash on the display.

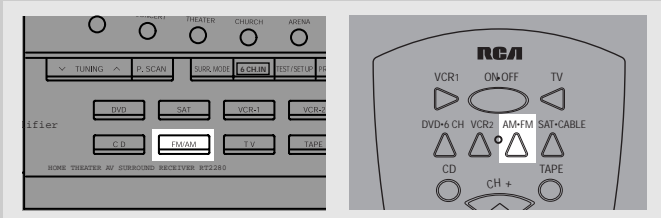

4- To select band, press the **AM/FM** button again to toggle between AM/FM mode. When an FM station broadcast Stereo sound, STEREO is displayed.

5- Tune the stations by pressing **TUNING UP** or **DOWN** repeatedly until the desired station is found. Alternatively, you can press and hold **TUNING UP** or **DOWN** for about one second to activate the automatic SEARCH function. In this mode the receiver will automatically tune frequencies until it finds a station

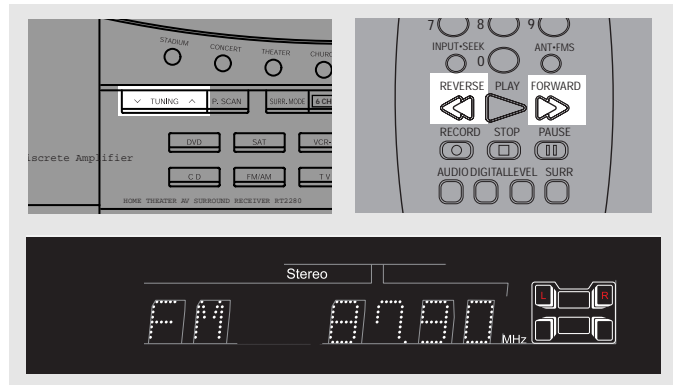

7. Repeat steps 5 or 6 to tune another radio station.

Select sound effect if needed by pressing Preset EQ or DSP sound (see "Advance sound section" for details)

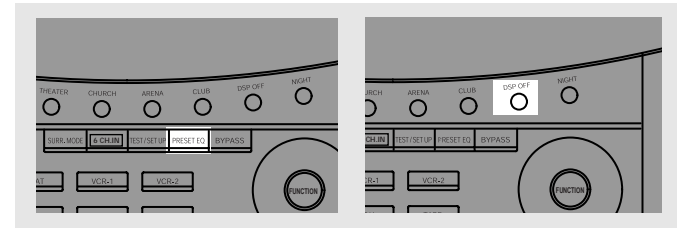

NOTE

1. If there is interference, modify the location of the antenna until the optimal sound is heard. TV and other electronic devices could be the cause of interferences so try to position the antenna away of them.

2. Weak signal can affect the "auto Search function". Adjust the antenna for better reception for more efficient search.

Storing radio stations:

The receiver can store up to 30 radio stations in memory. You can enter every single radio station yourself or the receiver can store all available radio station automatically in an ascending order.

Automatic preset storing :

1. Select the band wave by pressing **AM/FM** repeatedly

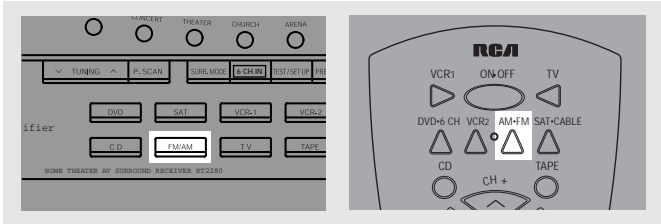

- 2- Press and hold **P.SCAN** for 3 seconds. "MEMORY" will be displayed in red and will blink during the automatic storing process.

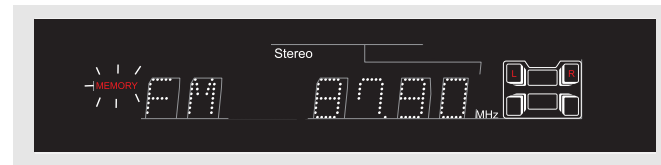
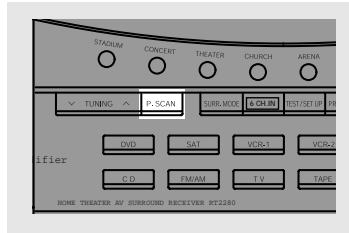

Radio frequencies will be browsed and radio station stored automatically. When all available radio stations are stored or if all 30 memory locations are full, the auto preset will stop.

NOTE

Weak signal can affect the "Automatic Preset Storing function" efficiency. Adjust the antenna for the best reception for more efficient search.

Manual preset

1. Select the band wave by pressing **AM/FM** repeatedly
2. Tune to a radio station (see "Manual tuning" on page 16 above for details)

3. Press **MENU** on the remote control. "MEMORY" will appear on the display

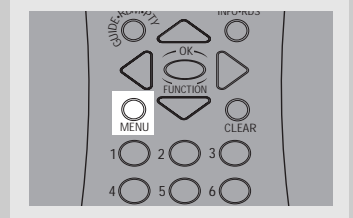

4. While the word "Memory" is still flashing, input your desired preset number (1-30) using the numeric keys on the remote control to store the radio station.

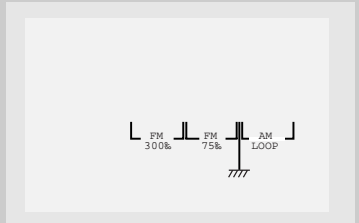

Operating your Receiver

Retrieving preset stations

1. Press **AM/FM** to select tuner mode

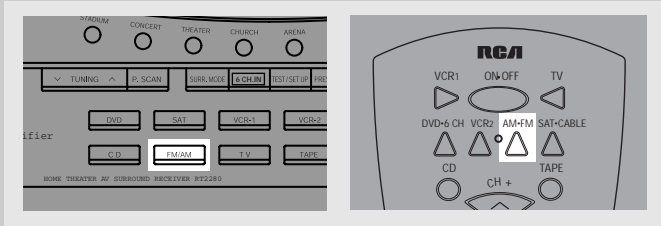

2. Rotate **MULTI JOG** on the receiver or press **CH+** or **CH-** buttons on the remote to select preset stations.

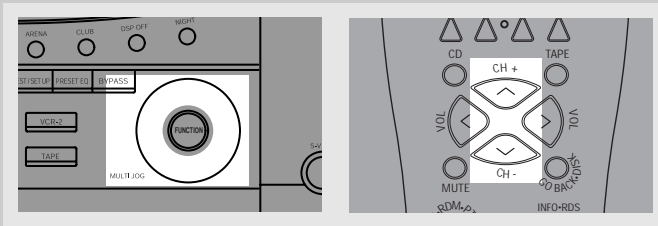

6 Channel external input

An external decoder (Dts, Dolby Digital, etc...) or a device with built-in multi-channel decoder and 6 channel output connector (DVD player, TV...) can be connected to the 6CH input. It is therefore possible to play any future 6 Channels coding (SACD, DVD Audio) thanks to this connection. The external decoder device will send the separated audio information to the receiver that will then amplify the signal and send to appropriate speakers.

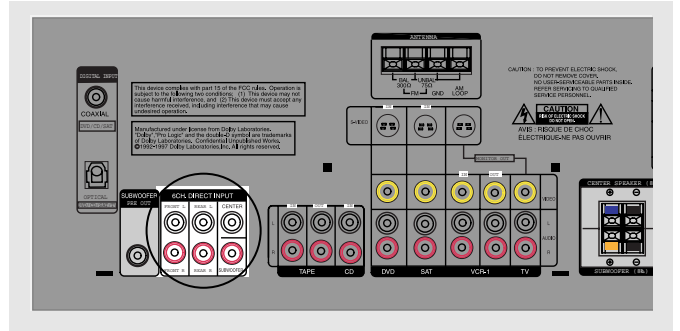

To activate 6 Channel external input, press **6 CH** on the receiver or press **DVD/6 CH** twice on the remote control.

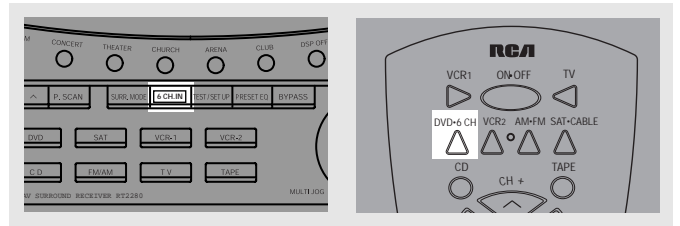

Sound Enhancement Systems

This receiver is equipped with several built-in sound enhancement systems.

Dolby Pro Logic and Dolby 3 Stereo

This surround system reproduces theater-like surround sound from Dolby-encoded software. The Pro Logic mode uses the built-in circuit to steer the Left, Center, Right and Surround channel audio signals and uses all five speakers and an optional subwoofer to play decoded Dolby Pro Logic program source, such as TV and VCR.

The 3 Stereo mode will redirect the Surround signals to the front left and right speakers when only the front and center speakers are used.

Use this mode to suit your speaker system configurations (such as size and number of speakers) and type of program (such as VCR).

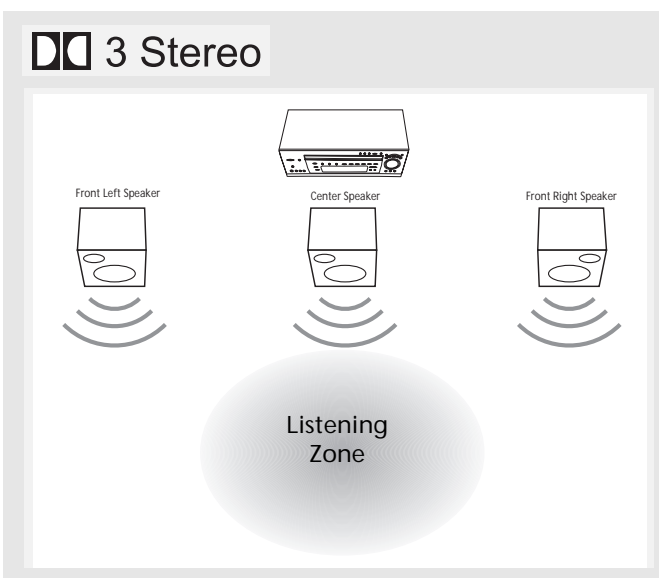
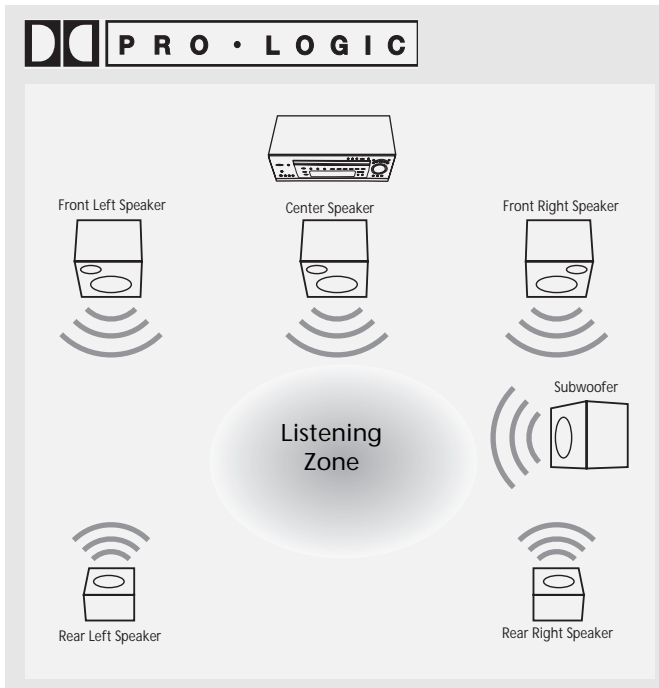

Dolby Digital

The Dolby Digital mode lets you enjoy full digital surround from software processed in the Dolby Digital format. Dolby Digital provides better sound quality and more powerful presence than conventional Dolby Surround.

This unit is equipped with Dolby Digital 5.1-channel so that you can enjoy enhanced full digital surround sound. Being different from Dolby Pro Logic in which only four channels (Front Left, Front Right, Centre and Rear) are used, the new system provides stereo separation of the rear speakers (Rear-Right, Rear-Left). These 5 channels, together with the subwoofer channel for bass sounds (counted as 0.1 channel), constitute as 5.1-Channel (or 6 Channels) Input for Dolby Digital that brings you the most sophisticated sound enjoyment.

Recording Dolby Digital Source

To record from a digital (optical or coaxial) input using a VCR/Tape that is connected to the receiver, the sound must be set to stereo first.

Press **SURR. MODE** to select stereo mode.

If the receiver is set to 5.1 sound information recording from surround speaker, the center speaker will not be recorded.

Advanced Sound Control

Stereo

The Stereo mode uses the two main channel outputs from the front speakers. Use this mode if you have connected the front speakers only.

DSP (Digital Sound Processor)

These digital sound effects resemble sounds in a real environment such as Stadium, Concert, Theater, Arena, Church, Club. DSP automatically converts analog audio signals to digital ones which enables you to adjust the sound without degrading the sound quality. Different modes will give you different feel of size and type of listening environment. (Not available in Dolby Digital (DVD))

Night Mode

By using Dynamic Range Compression technology, you can enjoy enhanced sound quality by Dolby Digital at night without interrupting your roommates or neighbors. While enjoying a Dolby Digital enabled component (DVD, SAT), you can activate Night Mode by pressing **NIGHT** button at the front of the receiver, and this mode will compress the difference in volume between normal voices and sounds like explosions. There are two modes (SOFT, SOFTER) for you to choose the extents of compression.

Fine Setting of the Components

The receiver has pre-selected the best surround mode for you once you turn on the unit by pressing the **Source** Buttons (like DVD, SAT, CD) directly. The default surround modes for different components are as table below.

If you decide to change the surround mode, you can press the **SURR MODE** repeatedly to toggle among the different surround mode choices and select the one you want.

Dolby Digital/Pro Logic → 3 Stereo → Stereo

Source/ Input	If Digital Input (optical or coaxial) is selected	If Analog Input is selected
DVD	Dolby Digital/PRO LOGIC	STEREO
SAT	Dolby Digital/PRO LOGIC	PRO LOGIC
VCR1	N/A	PRO LOGIC
VCR2	N/A	PRO LOGIC
TV	N/A	PRO LOGIC
CD	STEREO	STEREO
TAPE	N/A	STEREO
TUNER	N/A	STEREO

The receiver will keep the last selection in memory.

Input Signal Setting

The receiver defaults to the most convenient settings for your easiest use (see table).

If your connection is different from the default setting,

1. Select the source
2. Press **FUNCTION**
3. Rotate **MULTI JOG** to toggle among optical/ coaxial/ analog to match your connection. Your selection will be stored automatically.

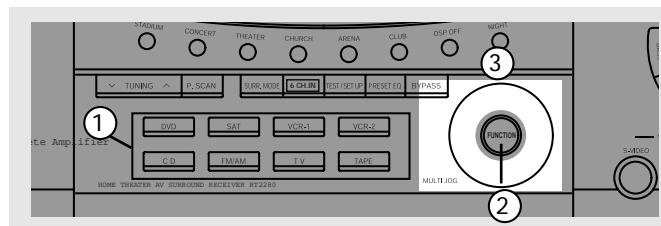

Every time you press the source button, the input setting (e.g. DVD/ OPTI) will be shown on display for a few seconds.

SOURCE	DEFAULT INPUT (as seen on display)
SAT	Coaxial (SAT/ COAX)
DVD	Optical (DVD/ OPTI)
CD	Analog (CD/ ANL)
VCR1	Analog (VCR1/ ANL)
VCR2	Analog (VCR2/ ANL)
FM/AM	Built-in Tuner
TAPE	Analog (TAPE/ ANL)
TV	Analog (TV / ANL)

Digital Input

Select this setting to play digital signals from a DVD, CD, LD player, SAT or TV.

NOTE

Digital input is only available for DVD, SAT, CD and TV

Analog Input

Select this setting to play analog signals from a cassette deck, VCR or turntable.

SOURCE	AVAILABLE INPUT
SAT	ANL/Optical/Coaxial
DVD	ANL/Optical/Coaxial
CD	ANL/Optical/Coaxial
VCR1	ANL/ - / -
VCR2	ANL/ - / -
TAPE	ANL/ - / -
TV	ANL/ Optical / -

Fine Setting of the Speakers

This receiver supports a wide range of speakers and subwoofers. For optimal surround sound enjoyment, you need to register the speaker selection settings of your audio system. If you buy this receiver with accompanied speaker package, then this step has been done for you.

Also, to make the surround sound more effective and suit the acoustic conditions in your listening room, you need to delay the signal from some of the speakers. Such channel delay compensates for center or surround speakers that are closer to listening position than the front speakers. You can make use of the **TEST/ SET UP** button to adjust the speakers' relative loudness.

The TEST/ SET UP button

You can adjust the relative loudness of the individual speakers by **TEST/ SET UP** button. In Dolby modes, press the button briefly. A short noise will be heard in the speakers one by one. The speaker having the noise at that moment will be shown in the display. You can listen to that speaker and rotate the **MULTI JOG** to adjust the level.

Advanced Setting

Factory defaulted Advance setting indication from VFD

The receiver has defaulted the following distances:

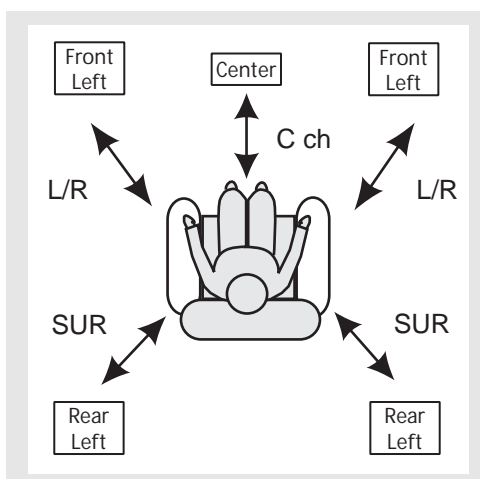

Front speakers (L/R) 15 ft
 Center speaker (Cch) 15 ft
 Rear speaker (SUR) 10 ft

Speaker Configurations

You can also change the setup of the speakers by pressing the **TEST/ SET UP** button until the display shows L/R SML or L/R LRG which enables you to set the size of the front speaker.

Available Selections:

Front Speaker selection	Large/ Small
Center Speaker selection	Large/ Small/ None
Surround Speaker selection	Large/ Small/ None
Subwoofer selection	Yes/ No
Subwoofer Phase	+ / -
Front Speaker distance	0-40 ft
Centre Speaker distance	0-40 ft
Rear Speaker distance	0-40 ft

Pressing **TEST/SETUP** repeatedly while the display is still showing L/R LRG (about 5 seconds), the display will toggle among: front, center, surround, subwoofer, subwoofer phase and speakers' distance setup. Set the speaker size or speakers' distance by rotating the **MULTI JOG**.

NOTE

- The sub-woofer selection will always be YES when the main speakers are set to small (SML).
- For the subwoofer phase setting, it will be affected by how you locate the subwoofer. Try both + and - settings and select the one that has better bass effect.
- If your unit comes with speakers (RT2280/2250), always set all speakers size to "small" to protect them and optimize the sound quality.

Advance Sound Control

Use a subwoofer to enjoy optimum sound.

- *Subwoofer Phase:* Try both settings and select the sound preferred.
- *Speaker distance:* For optimum surround experience measure the distance between the speaker and your favorite listening position.

1. Press and hold **TEST/SET UP** for 3 seconds

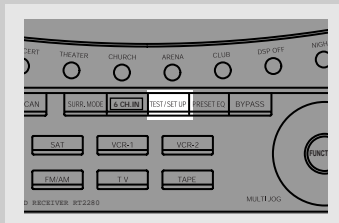

2. While the VFD display is showing L/R SML, rotate **MULTI JOG** to select and release to save setting.

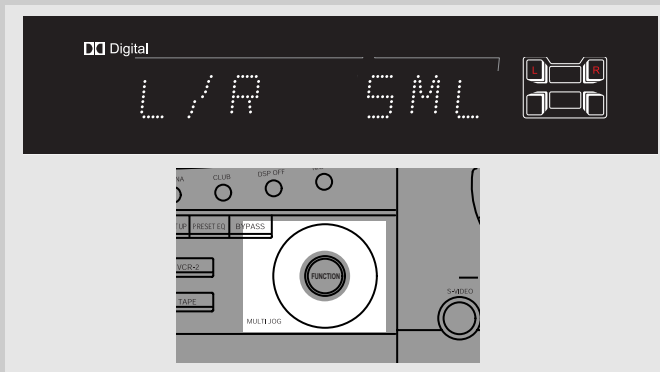

3. Press **TEST/SETUP** once to move to the next speaker setting.

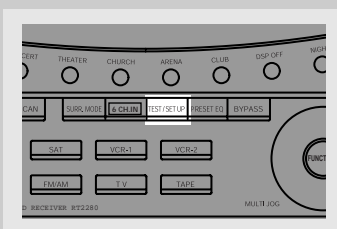

4. Repeat step 3 to set up the next speaker

6. When set up is done, wait for 5 seconds to automatically save your settings or press any source key to save your selection and set up mode.

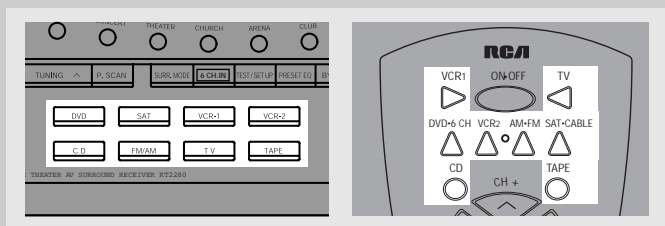

Speaker Icons

The receiver shows you the speakers' types and settings on the display with the following icons:

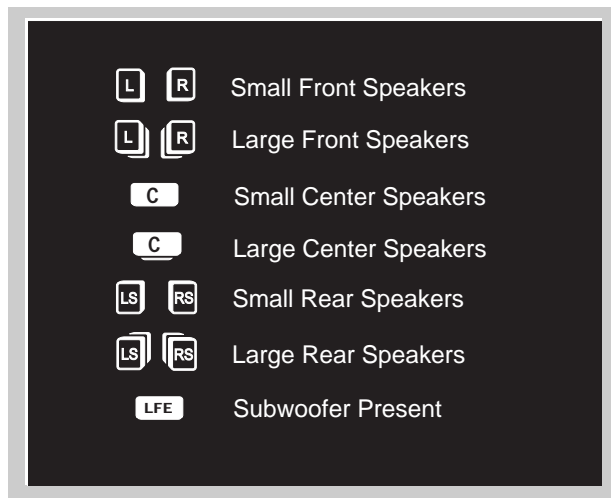

Displaying Program Formats

When a digital source is playing, the receiver will automatically switch to the proper surround mode and indicates on the speaker icons on the right-hand side of the display. (See diagram)

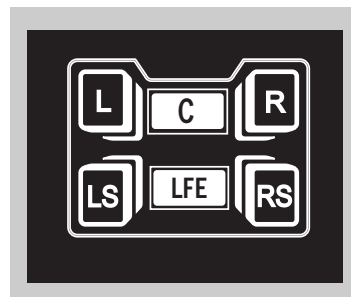

It is important to note, however, that not all Dolby Digital sources are encoded with the full complement of five channels plus LFE*. Speaker icons show how many and which speaker you have enabled (See "Fine Setting of the Speakers") and the letters inside the speaker icons show which channel is present in the source information. For example, the diagram shown means you have all the five speakers and subwoofer enabled and the digital sources you played have five channels plus LFE complemented.

* LFE stands for Low Frequency Effect. The indication "LFE" appears if the digital source contains LFE information. In this case, the bass signal will be delivered to the subwoofer, offering more dynamic deep bass sound effects. If the letter is flashing, the signal is either too weak or just gone.

Troubleshooting Tips

Receiver/Tuner Operation

STEREO indicator is off.

- Adjust the antenna.

The signal is Mono. Severe hum or noise.

- The signal is too weak. Connect an external antenna.

Remote Control Operation

The remote control does not operate the unit.

- Another function mode is selected on the remote. Press the correct Source Button.
- No batteries installed. (included with your system) Install the batteries before attempting to operate the remote. Be sure to match the + and - ends of each battery to the symbols shown in the remote battery compartment.
- The batteries are weak. Replace all batteries.
- The remote is not pointed at the remote control sensor on the main unit or there is an obstacle between the remote and the main unit.
- The remote control is too far from the main unit, move closer.

General

No audio.

- Make sure the speakers are connected.
- Check the input connections.
- Check the power cord connections.
- Make sure the MUTE indicator on the front panel is off.
- Make sure the digital setting (optical, coaxial or analog) is correct.

No audio from one channel.

- Check the speaker level setting.
- Check the speaker wire or cable connections.

Noise occurs when the TV is turned on.

- The TV is too close to the audio system.

Specific instruments sound displaced.

- Check the connections between the receiver and the speakers if the sound does not match the video.
- Press the Source Button for the video source.

Cleaning the Exterior

- Disconnect the system from AC power before cleaning the exterior of the system with a soft dust cloth, or with a slightly damp leather chamois. Never use strong solvents.

Equipment Specifications RT2280/RT2250:

AMPLIFIER SECTION:

All 5 channels:

RT2280: each 80W at 8 ohm. 0.9% THD @1 kHz

RT2250: each 50W at 8 ohm. 0.9% THD @1 kHz

Subwoofer channel: 100w at 8Ω (RT2280/RT2250 only)

Muting Attenuation: 65dB

Frequency Response: 40Hz to 20kHz +/-3dB

Signal to Noise Ratio: 65dB (Bypass mode)

VIDEO SECTION:

Input (Sensitivity/ Impedance):1Vp-p/ 75ohm

Output (Level/ Impedance): 1Vp-p/ 75 ohm

Frequency Response: 10Hz to 6MHz at +/- 3dB

Signal to noise ratio: 40dB

Crosstalk @3.58MHz: 40dB

AM TUNER SECTION:

Frequency Response: 80Hz – 2kHz +/-6dB

Usable Sensitivity: 800uV/m @ S/N 20dB

Signal to Noise: 38dB

Image Ratio: 27dB @ 1000kHz

IF Rejection: 35dB

FM TUNER SECTION:

Frequency Response: 40Hz – 15kHz +/-3dB

Quieting: 24dBu

Signal to Noise: 60dB(stereo) / 65dB(mono)

Image Ratio: 40dB

IF Rejection: 50dB

Remote Codes

CABLE CODES

ABC	5002, 5003, 5004, 5005, 5006, 5009, 5053
ANTRONIX	5008, 5009
ARCHER	5008, 5009, 5010, 5011
CABLETENNA	5008
CABLEVIEW	5008
CENTURY	5011
CITIZEN	5011
COLOUR VOICE	5012, 5013
COMTRONICS	5014, 5015
CONTEC	5016
EASTERN	5017
GARRARD	5011
GC ELECTRONICS	5009
GEMINI	5018, 5019, 5049
GENERAL INSTRUMENT	5003
HAMLIN	5020, 5021, 5022, 5035, 5045
HITACHI	5003
HYTEX	5002
JASCO	5011
JERROLD	5003, 5005, 5007, 5018, 5023, 5024, 5046, 5053
MAGNAVOX	5025
MEMOREX	5026
MOVIE TIME	5002, 5027, 5028
NSC	5002, 5027, 5028
OAK	5002, 5016, 5029
PANASONIC	5048, 5052
PARAGON	5026
PHILIPS	5011, 5012, 5013, 5019, 5025, 5030, 5031, 5032
PIONEER	5033, 5034
PULSAR	5026
RCA	5047, 5049, 5052
REALISTIC	5009, 5049
REGAL	5022, 5035
REGENCY	5017
REMBRANDT	5003
RUNCO	5026
SAMSUNG	5014, 5034
SCIENTIFIC ATLANTA	5006, 5036, 5037, 5038
SIGNAL	5014, 5018
SIGNATURE	5003
SL MARX	5014
SPRUCER	5052
STARCOM	5007, 5018, 5053
STARGATE	5014, 5018
STARQUEST	5018
TANDY	5040
TELEVIEW	5014
TOCOM	5004, 5023, 5041
TOSHIBA	5026
TUSA	5018
TV86	5027
UNIKA	5008, 5009, 5011
UNITED ARTISTS	5002
UNITED CABLE	5053
UNIVERSAL	5008, 5009, 5010, 5011
VIDEOWAY	5044
VIEWSTAR	5015, 5025, 5027, 5040
ZENITH	5026, 5050, 5051

VCR CODES

ADMIRAL	2131
ADVENTURA	2026
AIKO	2027
AIWA	2002, 2026
AKAI	2003, 2004, 2005, 2007, 2008, 2111, 2112, 2113
AMERICAN HIGH	2021
ASHA	2013
AUDIO DYNAMICS	2009, 2010
AUDIOVOX	2014
BELL & HOWELL	2011
BEAUMARK	2013
BROKSONIC	2012, 2025
CALIX	2014
CANDLE	2013, 2014, 2015, 2016, 2017, 2018, 2019
CANON	2021, 2022, 2114
CAPEHART	2020, 2110
CARVER	2062
CCE	2027, 2061
CITIZEN	2013, 2014, 2015, 2016, 2017, 2018, 2019, 2027
COLORTYME	2009
COLT	2061
CRAIG	2013, 2014, 2023, 2061
CURTIS-MATHES	2000, 2002, 2009, 2013, 2016, 2018, 2021, 2022, 2024, 2115
CYBERNEX	2013
DAEWOO	2015, 2017, 2019, 2025, 2026, 2027, 2028, 2110
DAYTRON	2110
DBX	2009, 2010
DIMENSIA	2000
DYNATECH	2002, 2026
ELECTROHOME	2014, 2029
ELECTROPHONIC	2014
EMERSON	2002, 2012, 2014, 2015, 2021, 2024, 2025, 2026, 2029, 2030, 2032, 2033, 2034, 2035, 2036, 2037, 2038, 2039, 2040, 2041, 2042, 2044, 2045, 2047, 2065, 2105, 2113, 2116, 2117, 2130
FISHER	2011, 2023, 2048, 2049, 2050, 2051, 2052, 2118
FUJI	2021, 2119
FUNAI	2002, 2026
GARRARD	2026
GE	2000, 2001, 2013, 2021, 2022, 2053, 2115, 2120
GOLDSTAR	2009, 2014, 2018, 2054, 2121
GRADIENTE	2026
HARLEY DAVIDSON	2026
HARMAN KARDON	2009
HARWOOD	2061
HEADQUARTER	2011
HITACHI	2002, 2055, 2056, 2057, 2107, 2111, 2120, 2122
HI-Q	2023
INSTANT REPLAY	2021
JCI	2021
JC PENNEY	2009, 2010, 2011, 2013, 2014, 2021, 2022, 2055, 2056, 2058, 2059, 2060, 2107, 2118
JENSEN	2055, 2056, 2111
JVC	2009, 2010, 2011, 2018, 2058, 2111, 2123
KENWOOD	2009, 2010, 2011, 2016, 2018, 2058, 2111, 2123
KLH	2061
KODAK	2014, 2021
LLOYD	2002, 2026
LOGIK	2061
LXI	2014
MAGNAVOX	2021, 2022, 2062, 2063, 2104, 2108, 2124
MAGNIN	2013
MARANTZ	2009, 2010, 2011, 2016, 2018, 2021, 2058, 2062, 2064
MARTA	2014
MASUSHITA	2021
MEI	2021

MEMOREX	2002, 2011, 2013, 2014, 2021, 2023, 2026, 2104, 2131
MGA	2029, 2065, 2113
MGN TECHNOLOGY	2013
MIDLAND	2053
MINOLTA	2055, 2056, 2107
mitsubishi	2029, 2055, 2056, 2065, 2066, 2067, 2069, 2070, 2071, 2072, 2073, 2074, 2106, 2113, 2123
MONTGOMERY WARD	2075, 2131
MOTOROLA	2021, 2131
MTC	2002, 2013, 2026
MULTITECH	2002, 2013, 2016, 2026, 2053, 2061
NEC	2009, 2010, 2011, 2016, 2018, 2058, 2064, 2076, 2078, 2079, 2111, 2123
NIKKO	2014
NOBLEX	2013
OLYMPUS	2021
OPTIMUS	2014, 2131
OPTONICA	2096
ORION	2035
PANASONIC	2021, 2022, 2109, 2125, 2126, 2127
PENTAX	2016, 2055, 2056, 2107, 2120
PENTEX RESEARCH	2018
PHILCO	2021, 2022, 2062, 2063
PHILIPS	2021, 2062, 2096, 2124
PILOT	2014
PIONEER	2010, 2055, 2080, 2081, 2123
PORTLAND	2016, 2017, 2019, 2110
PROSCAN	2000, 2001
PROTEC	2061
PULSAR	2104
QUARTER	2011
QUARTZ	2011
QUASAR	2021, 2022, 2125
RCA	2000, 2001, 2003, 2013, 2021, 2055, 2056, 2082, 2083, 2084, 2085, 2086, 2087, 2088, 2089, 2090, 2091, 2107, 2115, 2120, 2125
RADIOSHACK/REALISTIC	2002, 2011, 2013, 2014, 2021, 2022, 2023, 2026, 2029, 2049, 2050, 2096, 2131
RADIX	2014
RANDEX	2014
RICOH	2128
RUNCO	2104
SAMSUNG	2005, 2013, 2015, 2033, 2053, 2112
SANKY	2104, 2131
SANSUI	2010, 2092, 2111, 2123
SANYO	2011, 2013, 2023
SCOTT	2012, 2015, 2025, 2032, 2035, 2038, 2065, 2093, 2116
SEARS	2011, 2014, 2021, 2023, 2048, 2049, 2050, 2051, 2055, 2056, 2107, 2118
SHARP	2002, 2017, 2029, 2094, 2095, 2096, 2131
SHINTOM	2004, 2056, 2061, 2098
SHOGUN	2013
SIGNATURE	2002, 2131
SINGER	2021, 2061, 2128
SONY	2002, 2004, 2098, 2099, 2119, 2128
STS	2021, 2107
SYLVANIA	2002, 2021, 2022, 2026, 2062, 2063, 2065, 2124
SYMPHONIC	2002, 2026
TANDY	2002, 2011
TASHIKO	2014
TATUNG	2058, 2111
TEAC	2002, 2026, 2058, 2085, 2111
TECHNICS	2021, 2109
TEKNIKA	2002, 2014, 2021, 2026, 2100, 2129
TMK	2013, 2024, 2047
TOSHIBA	2015, 2049, 2051, 2055, 2065, 2093, 2116
TOTEVISION	2013, 2014
UNITECH	2013
VECTOR RESEARCH	2009, 2010, 2015, 2016
VICTOR	2010
VIDEO CONCEPTS	2009, 2010, 2015, 2016, 2113
VIDEOSONIC	2013
WARDS	2002, 2013, 2014, 2015, 2021, 2023, 2026, 2029, 2055, 2056, 2061, 2096, 2101, 2102, 2103, 2107, 2116, 2131
XR-1000	2021, 2026, 2061
YAMAHA	2009, 2010, 2011, 2018, 2058, 2111
ZENITH	2004, 2098, 2104, 2119, 2128

TV CODES

ABEX	1172
ADMIRAL	1001, 1173
ADVENTURA	1174
AIKO	1016
AKAI	1002
ALLERON	1046
AMTRON	1038
ANAM NATIONAL	1003, 1038
AOC	1004, 1005, 1006, 1007, 1175, 1176
AUDIOVOX	1038
BELCOR	1004
BELL & HOWELL	1001, 1083, 1162
BRADFORD	1038
BROKWOOD	1004
CANDLE	1004, 1006, 1008, 1174
CAPEHART	1175
CELEBRITY	1002
CENTURION	1009
CITIZEN	1004, 1006, 1008, 1016, 1038, 1105, 1171, 1174, 1177
CLAIRTONE	1176
COLORTYME	1004, 1006
CONCERTO	1004, 1006
CONTEC/CONY	1012, 1013, 1014, 1038, 1176
CRAIG	1038
CROWN	1038, 1171
CURTIS MATHES	1000, 1004, 1006, 1015, 1105, 1162, 1171
CXC	1038
DAEWOO	1004, 1005, 1006, 1016, 1017, 1018, 1127, 1171
DAYTRON	1004, 1006, 1171
DIMENSIA	1000
DUMONT	1004, 1151
DYNATECH	1178
ELECTROBAND	1002, 1176
ELECTROHOME	1003, 1004, 1006, 1019, 1022
EMERSON	1004, 1006, 1012, 1014, 1023, 1024, 1025, 1026, 1027, 1028, 1029, 1030, 1031, 1032, 1033, 1034, 1035, 1036, 1037, 1038, 1039, 1041, 1042, 1043, 1044, 1046, 1047, 1123, 1124, 1162, 1171, 1176, 1177, 1179, 1191
ENVISION	1004, 1006
FISHER	1048, 1049, 1050, 1051, 1162, 1180
FUJITSO	1046
FUNAI	1038, 1046
FUTURETEC	1038
GE	1000, 1003, 1004, 1006, 1022, 1052, 1054, 1055, 1087, 1164, 1165, 1166, 1167, 1168, 1181
GIBRALTER	1004, 1151
GOLDSTAR	1004, 1005, 1006, 1012, 1019, 1056, 1057, 1058, 1155, 1156, 1171, 1172
GRUNDY	1038, 1046, 1171
HALLMARK	1004, 1006
HARVARD	1038
HITACHI	1004, 1006, 1012, 1013, 1059, 1060, 1061, 1135, 1136, 1137, 1138, 1139, 1140, 1141, 1142, 1143, 1144, 1145, 1146, 1148, 1150, 1179
IMA	1038
INFINITY	1062
JANEIL	1174
JBL	1062
JCB	1002
JC PENNY	1000, 1004, 1005, 1006, 1008, 1022, 1052, 1054, 1058, 1063, 1064, 1072, 1087, 1105, 1128, 1171, 1172, 1181
JENSEN	1004, 1006
JVC	1012, 1013, 1054, 1060, 1065, 1066, 1067, 1089, 1157, 1158, 1159, 1182

Remote Codes

KAWASHO	2002, 1004, 1006
KAYPANI	1175
KENWOOD	1004, 1006, 1019
KLOSS NOVABEAM	1068, 1069, 1174, 1183
KTV	1038, 1070, 1171, 1176, 1177
LOEWE	1062
LOGIK	1083
LUXMAN	1004, 1006
LXI	1000, 1006, 1049, 1062, 1071, 1072, 1073, 1162, 1181
MAGNAVOX	1004, 1006, 1008, 1019, 1062, 1068, 1069, 1074, 1075, 1076, 1077, 1088, 1089, 1130, 1131, 1132, 1133, 1134, 1183, 1184
MAJESTIC	1083
MARANTS	1062
MARANTZ	1004, 1006, 1062, 1078
MEGATRON	1006, 1059
MEI	1176
MEMOREX	1001, 1006, 1082, 1083, 1162
MGA	1004, 1005, 1006, 1019, 1022, 1051, 1079, 1080, 1082
MIDLAND	1054, 1151, 1171, 1172, 1181
MINUTZ	1052
MITSUBISHI	1004, 1005, 1006, 1019, 1022, 1051, 1079, 1080, 1081, 1082, 1082, 1083, 1125
MONTGOMERY WARD	1083
MOTOROLA	1003, 1173
MTC	1004, 1005, 1006, 1105, 1176, 1178
MULTITECH	1038, 1178
MULTIVISION	1084
NAD	1006, 1071, 1072, 1185
NEC	1003, 1004, 1005, 1006, 1089
NIKKO	1006, 1016
NTC	1016
ONWA	1038
OPTIMUS	1185
OPTONICA	1095, 1173
ORION	1035, 1191
PANASONIC	1003, 1054, 1062, 1170
PHILCO	1003, 1004, 1005, 1006, 1008, 1012, 1019, 1062, 1068, 1069, 1074, 1075, 1077, 1183, 1184
PHILIPS	1003, 1004, 1008, 1012, 1019, 1062, 1068, 1069, 1074, 1075, 1076, 1086, 1087, 1088, 1089
PILOT	1004, 1171
PIONEER	1004, 1006, 1090, 1091, 1092, 1179, 1185
PORTLAND	1004, 1005, 1006, 1016, 1171
PRICE CLUB	1105
PRISM	1054
PROSCAN	1000, 1181
PROTON	1004, 1006, 1012, 1093, 1175
PULSAR	1151
PULSER	1004
QUASAR	1003, 1054, 1070, 1094
RADIO SHACK/REALISTIC	1000, 1004, 1006, 1012, 1038, 1049, 1095, 1162, 1171, 1172
RCA	1000, 1003, 1004, 1005, 1006, 1007, 1019, 1096, 1098, 1099, 1100, 1101, 1102, 1103, 1129, 1179, 1181, 1187, 1188, 1190
RHAPSODY	1176
RUNCO	1151
SAMPO	1004, 1006, 1171, 1172, 1175
SAMSUNG	1004, 1005, 1006, 1012, 1015, 1019, 1104, 1105, 1106, 1171, 1172
SAMSUX	1171
SANSUI	1191
SANYO	1004, 1048, 1049, 1050, 1080, 1107, 1108, 1162, 1169, 1180, 1189
SCOTCH	1006
SCOTT	1004, 1006, 1012, 1024, 1035, 1038, 1046
SEARS	1000, 1004, 1006, 1013, 1019, 1046, 1048, 1049, 1050, 1051, 1066, 1071, 1072, 1109, 1110, 1162, 1180, 1181, 1189
SHARP	1004, 1006, 1012, 1029, 1095, 1111, 1112, 1113, 1122, 1171, 1173
SHOGUN	1004
SIGNATURE	1001, 1083, 1115

SIMPSON	1008
SONIC	1176
SONY	1002
SOUNDESIGN	1004, 1006, 1008, 1038, 1046
SQUAREVIEW	1189
SSS	1004, 1038
STARLITE	1038
SUPRE-MACY	1174
SUPREME	1002
SYLVANIA	1004, 1006, 1008, 1019, 1062, 1068, 1069, 1074, 1075, 1076, 1077, 1088, 1116, 1161, 1183, 1184
SYMPHONIC	1033, 1038, 1189
TANDY	1173
TATUNG	1003, 1178
TECHNICS	1054
TECHWOOD	1004, 1006, 1054
TEKNIKA	1004, 1005, 1006, 1008, 1012, 1013, 1016, 1038, 1046, 1076, 1082, 1083, 1105, 1170, 1171
TELECATION	1117
TMK	1004, 1006
TOSHIBA	1049, 1071, 1072, 1089, 1105, 1109, 1117, 1118, 1160, 1162
TOTEVISION	1171
UNIVERSAL	1052, 1087
VICTOR	1066, 1182
VIDTECH	1004, 1005, 1006
VIKING	1174
WARDS	1000, 1001, 1004, 1005, 1006, 1019, 1024, 1033, 1046, 1052, 1062, 1069, 1074, 1075, 1076, 1083, 1087, 1088, 1095, 1119, 1120, 1184
YAMAHA	1004, 1005, 1006, 1019
ZENITH	1004, 1083, 1151, 1152, 1153, 1154

Satellite Receivers

CHAPPARAL	5056, 5057
DRAKE	5058, 5059
GE SATELLITE RECEIVER	5000, 5001
GENERAL INSTRUMENTS	5060, 5061, 5062
PANASONIC SATELLITE RECEIVER	
5075	
PRIMESTAR DBS	5076
PROSCAN SATELLITE RECEIVER	
5000, 5001	
RCA SATELLITE RECEIVER	5000, 5001
REALISTIC	5063
SONY SATELLITE RECEIVER	5072
STS1	5064
STS2	5065
STS3	5066
STS4	5067
TOSHIBA	5068
TOSHIBA SATELLITE RECEIVER	5073
UNIDEN SATELLITE RECEIVER	5069

Audio (RCA/Dimensia only)

AM/FM	4003
AUX	4004
PHONO	4005
CD	4007
TAPE	4006

Laser disc Players

PROSCAN	2001
RCA	2001

What your warranty covers:

- Defects in materials or workmanship.

For how long after your purchase:

- One year from date of purchase for labor and parts
- The warranty period for rental units begins with the first rental or 45 days from date of shipment to the rental firm, whichever comes first.

What we will do:

- Pay any Authorized RCA Audio Service Center the labor charges to repair your unit.
- Pay any Authorized RCA Audio Service Center for the new or, at our option, refurbished replacement parts required to repair your unit.

How you get service:

- Take your unit to any Authorized RCA Audio Service Center. To identify your nearest Authorized RCA Audio Service Center, ask your dealer, look in the Yellow Pages, or call 1-800-336-1900.
- Show the Authorized Service Center Representative your evidence of purchase date or first rental.
- Pick up your unit when repairs are completed.
- Proof of purchase in the form of a bill of sale or receipted invoice which is evidence that the product is within the warranty period must be presented to obtain warranty service. For rental firms, proof of first rental is also required.

What your warranty does not cover:

- Customer instruction. (Your Owner's Manual describes how to install, adjust, and operate your unit. Any additional information should be obtained from your dealer.)
- Installation and related adjustments.
- Signal reception problems not caused by your unit.
- Damage from misuse or neglect.
- Cleaning of audio heads.
- Batteries.
- A unit that has been modified or incorporated into other products or is used for institutional or other commercial purposes.
- A unit purchased or serviced outside the U.S.A.
- Acts of nature, such as but not limited to lightning damage.

Product Registration:

- Please complete and mail the Product Registration Card packed with your product. It will make it easier to contact you should it ever be necessary. The return of the card is not required for warranty coverage.

Limitation of Warranty:

- **THE WARRANTY STATED ABOVE IS THE ONLY WARRANTY APPLICABLE TO THIS PRODUCT. ALL OTHER WARRANTIES, EXPRESS OR IMPLIED (INCLUDING ALL IMPLIED WARRANTIES OF MERCHANTABILITY OR FITNESS FOR A PARTICULAR PURPOSE) ARE HEREBY DISCLAIMED. NO VERBAL OR WRITTEN INFORMATION GIVEN BY THOMSON MULTIMEDIA INC., ITS AGENTS OR EMPLOYEES SHALL CREATE A WARRANTY OR IN ANY WAY INCREASE THE SCOPE OF THIS WARRANTY.**
- **REPAIR OR REPLACEMENT AS PROVIDED UNDER THIS WARRANTY IS THE EXCLUSIVE REMEDY OF THE CONSUMER. THOMSON MULTIMEDIA INC. SHALL NOT BE LIABLE FOR INCIDENTAL OR CONSEQUENTIAL DAMAGES RESULTING FROM THE USE OF THIS PRODUCT OR ARISING OUT OF ANY BREACH OF ANY EXPRESS OR IMPLIED WARRANTY ON THIS PRODUCT. THIS DISCLAIMER OF WARRANTIES AND LIMITED WARRANTY ARE GOVERNED BY THE LAWS OF THE STATE OF INDIANA. EXCEPT TO THE EXTENT PROHIBITED BY APPLICABLE LAW, ANY IMPLIED WARRANTY OF MERCHANTABILITY OR FITNESS FOR A PARTICULAR PURPOSE ON THIS PRODUCT IS LIMITED TO THE APPLICABLE WARRANTY PERIOD SET FORTH ABOVE.**

How State Law relates to warranty:

- Some states do not allow the exclusion nor limitation of incidental or consequential damages, or limitations on how long an implied warranty lasts, so the above limitations or exclusions may not apply to you.
- This warranty gives you specific legal rights, and you also may have other rights that vary from state to state.

If you purchased your unit outside the United States:

- This warranty does not apply. Contact your dealer for warranty information.

Service calls which do not involve defective materials or workmanship are not covered by this warranty. Costs of such service calls are the sole responsibility of the purchaser.

Limited Warranty (Canada)

What your warranty covers:

- Defects in materials or workmanship.

For how long after your purchase:

- One year from date of purchase for labor and parts
- The warranty period for rental units begins with the first rental or 45 days from date of shipment to the rental firm, whichever comes first.

What we will do:

- Pay any Authorized RCA Audio Service Center the labor charges to repair your unit.
- Pay any Authorized RCA Audio Service Center for the new or, at our option, refurbished replacement parts required to repair your unit.

How you get service:

- Take your unit to any Authorized RCA Audio Service Center. To identify your nearest Authorized RCA Audio Service Center, ask your dealer, look in the Yellow Pages, or call 1-800-336-1900.
- Show the Authorized Service Center Representative your evidence of purchase date or first rental.
- Pick up your unit when repairs are completed.
- Proof of purchase in the form of a bill of sale or receipted invoice which is evidence that the product is within the warranty period must be presented to obtain warranty service. For rental firms, proof of first rental is also required.

What your warranty does not cover:

- Customer instruction. (Your Owner's Manual describes how to install, adjust, and operate your unit. Any additional information should be obtained from your dealer.)
- Installation and related adjustments.
- Signal reception problems not caused by your unit.
- Damage from misuse or neglect.
- Cleaning of audio heads.
- Batteries.
- A unit that has been modified or incorporated into other products or is used for institutional or other commercial purposes.
- A unit purchased or serviced outside Canada.
- Acts of nature, such as but not limited to lightning damage.

Product Registration:

- Please complete and mail the Product Registration Card packed with your product. It will make it easier to contact you should it ever be necessary. The return of the card is not required for warranty coverage.

Limitation of Warranty:

- THE WARRANTY STATED ABOVE IS THE ONLY WARRANTY APPLICABLE TO THIS PRODUCT. NO VERBAL OR WRITTEN INFORMATION GIVEN BY THOMSON MULTIMEDIA LTD., ITS AGENTS OR EMPLOYEES SHALL CREATE A WARRANTY OR IN ANY WAY INCREASE THE SCOPE OF THIS WARRANTY.
- REPAIR OR REPLACEMENT AS PROVIDED UNDER THIS WARRANTY IS THE EXCLUSIVE REMEDY OF THE CONSUMER. THOMSON MULTIMEDIA LTD. SHALL NOT BE LIABLE FOR INCIDENTAL OR CONSEQUENTIAL DAMAGES RESULTING FROM THE USE OF THIS PRODUCT. EXCEPT TO THE EXTENT PROHIBITED BY APPLICABLE PROVINCIAL LAW, ANY IMPLIED WARRANTY OF MERCHANTABILITY OR FITNESS FOR A PARTICULAR PURPOSE ON THIS PRODUCT IS LIMITED TO THE APPLICABLE WARRANTY PERIOD SET FORTH ABOVE.

How Provincial Laws relates to warranty:

- This warranty gives you specific legal rights which are in addition to statutory warranties that may vary from Province to Province.

If you purchased your unit outside Canada:

- This warranty does not apply. Contact your dealer for warranty information.

Service calls which do not involve defective materials or workmanship are not covered by this warranty. Costs of such service calls are the sole responsibility of the purchaser.

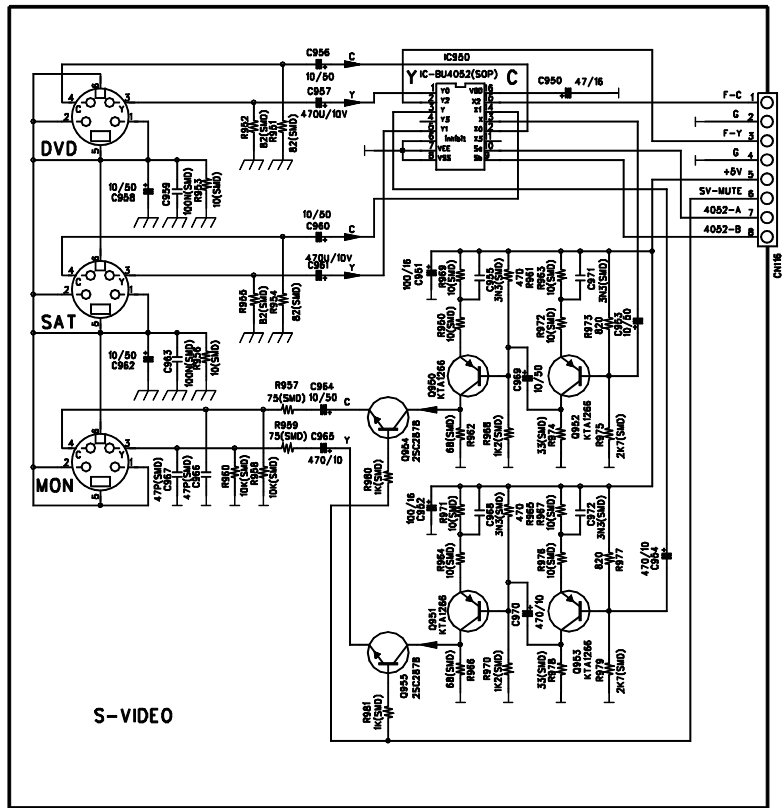

Audio Inputs

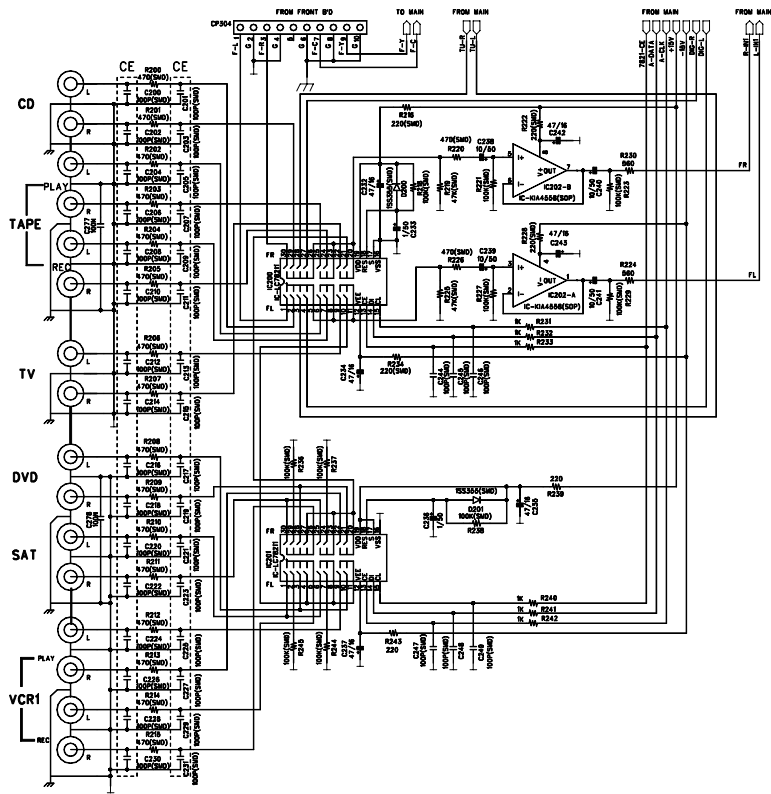

DSP/AC3 Theory of Operation

In order to easily diagnose the operation of the DSP/AC3 board one must have an understanding of its operation. The below circuit description is provided to familiarize you with its functions and how an audio signal is processed by the circuit.

The DSP/AC3 provides two basic functions, analog signal processing and digital signal processing. For a better understanding of its operation refer to the IC block diagrams. We will cover the analog signal flow first and then the digital.

The right and left analog signal enter the board via CP401 pins 7 and 9 respectively, IC11 and 12 then amplify the signals. Once amplified the signals are sent to IC1 pins 16 and 20. IC1 converts the analog signal to a digital signal and it exits IC1 as a Serial Digital signal, SDOUT, on pin 4. The SD signal is then sent to IC5 pin 27 for processing. IC5 determines if the signal is a standard surround sound signal or Dolby ProLogic signal. The function of IC5 is determined by data from IC19. IC19 acts as a buffer for data from the main system control microprocessor. These signals will determine if the DSP IC, IC5, is in the Dolby ProLogic, concert, stadium, theater, church, arena, or club mode. The digital signal is then processed by IC5 and exits as three digital signals at pins 39, 40 and 41. These signals then enter IC1 on pins 1, 2 and 3. IC1 decodes the three digital signals into appropriate analog signals and processes them out pins 23 through 26 to IC6, 7 and 8. IC6, 7 and 8 then amplify the signal and it is processed out CP402 pins 1(LF), 3(RF), 5(C), 7(S-L), 9(S-R) and 11(SW).

A digital signal can be provided by either the COAX-IN or Optical cable. The Coax in is delivered to IC14 pin 4 and the Optical signal is delivered to IC14 pin 12. The digital signal contains the audio information and a timing or clock signal. The clock is processed by IC14 and OCLK exits on pin 16 and OLRCK at pin 17. The two clock signal are then buffered by IC18 and sent on to IC1 and IC5 for timing. The digital audio is processed into an SD (Serial Digital) signal and processed out pin 18 to pin 22 of IC5. IC5 then determines if the signal is an AC-3 or DTS signal. As in the analog mod, the data from IC19 determines the mode of the DSP. After being processed by IC5 the Digital signal exits IC5 as three digital signals on pin 39, 40 and 41. These signals then enter IC1 on pins 1, 2 and 3. IC1 decodes the three digital signals into appropriate analog signals and processes them out pins 23 through 26 to IC6, 7 and 8. IC6, 7 and 8 then amplify the signal and it is processed out CP402 pins 1(LF), 3(RF), 5(C), 7(S-L), 9(S-R) and 11(SW).

RT2280 IC COMPLIMENT

IC#	TYPE	FUNCTION	DATA SHEET
IC1	CS4228	24-Bit, 96 kHz Surround Sound Codec	YES
IC101	78M06	Voltage Regulator +6 Volts	N/A
IC102	78M15	Voltage Regulator +15 Volts	N/A
IC103	79M15	Voltage Regulator – 15 Volts	N/A
IC104	7805	Voltage Regulator +5 Volts	N/A
IC106	BA33T	Voltage Regulator +3.3 Volts	N/A
IC107	BU4053	Triple 2-Channel Analog Switch	NO
IC108	KIA4558	Dual Low Noise OPAMP	N/A
IC11	NJM2068DD	Dual Wide Band OPAMP	N/A
IC12	NJM2068DD	Dual Wide Band OPAMP	N/A
IC14	CS8415	96 kHz Digital Audio Interface Receiver	YES
IC18	74VHC244FW	Octal Buffer/Line Driver	YES
IC19	74VHC244FW	Octal Buffer/Line Driver	YES
IC200	LC78211	Analog Switch	NO
IC201	LC78211	Analog Switch	NO
IC202	KIA4558	Dual Low Noise OPAMP	N/A
IC300	KIC9162	Analog Switch	NO
IC300	CXP8228	System Control Microprocessor	NO
IC301	KIA4558	Dual Low Noise OPAMP	N/A
IC302	KIA4558	Dual Low Noise OPAMP	N/A
IC303	KIA4558	Dual Low Noise OPAMP	N/A
IC400	SM7346	Multi-channel Volume Control	NO
IC401	KIA4558	Dual Low Noise OPAMP	N/A
IC402	KIA4558	Dual Low Noise OPAMP	N/A
IC403	KIA4558	Dual Low Noise OPAMP	N/A
IC5	CS49325	MPEG, DTS, Dolby Decoder	YES
IC6	NJM2068DD	Dual Low Noise OPAMP	N/A
IC7	NJM2068DD	Dual Low Noise OPAMP	N/A
IC8	NJM2068DD	Dual Low Noise OPAMP	N/A
IC950	BU4052	Analog Switch	NO

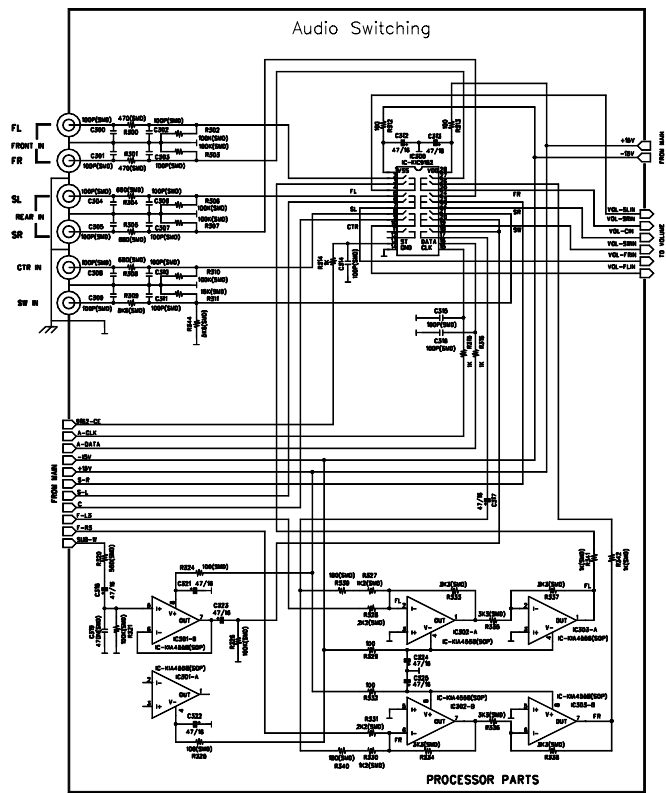

Front Display and System Control

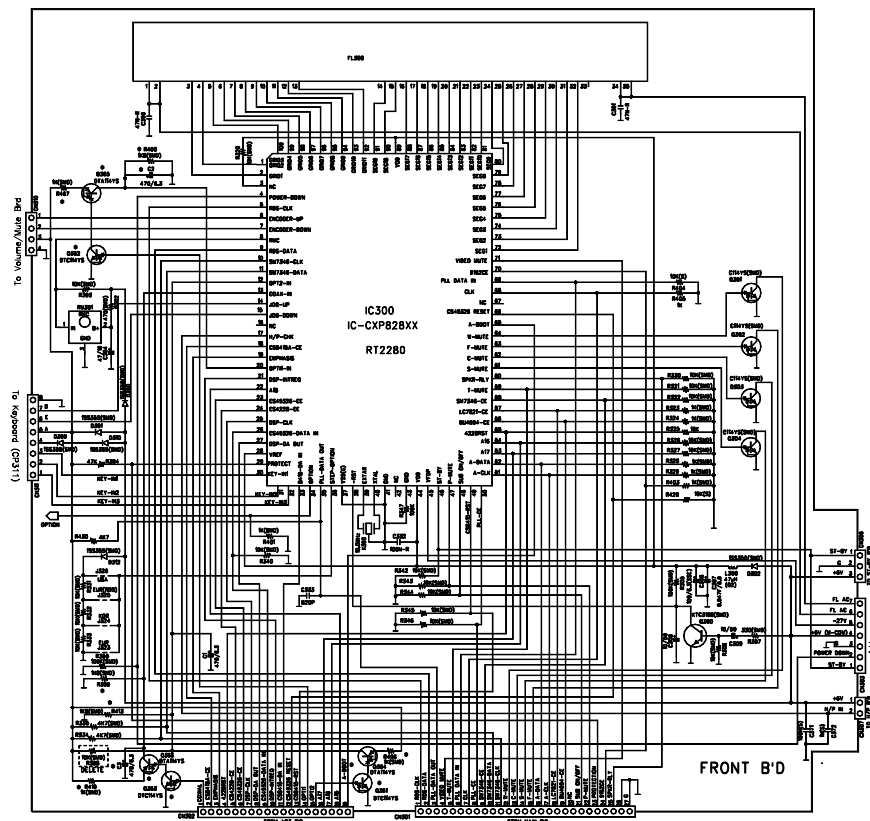

DSP/AC3 Schematic

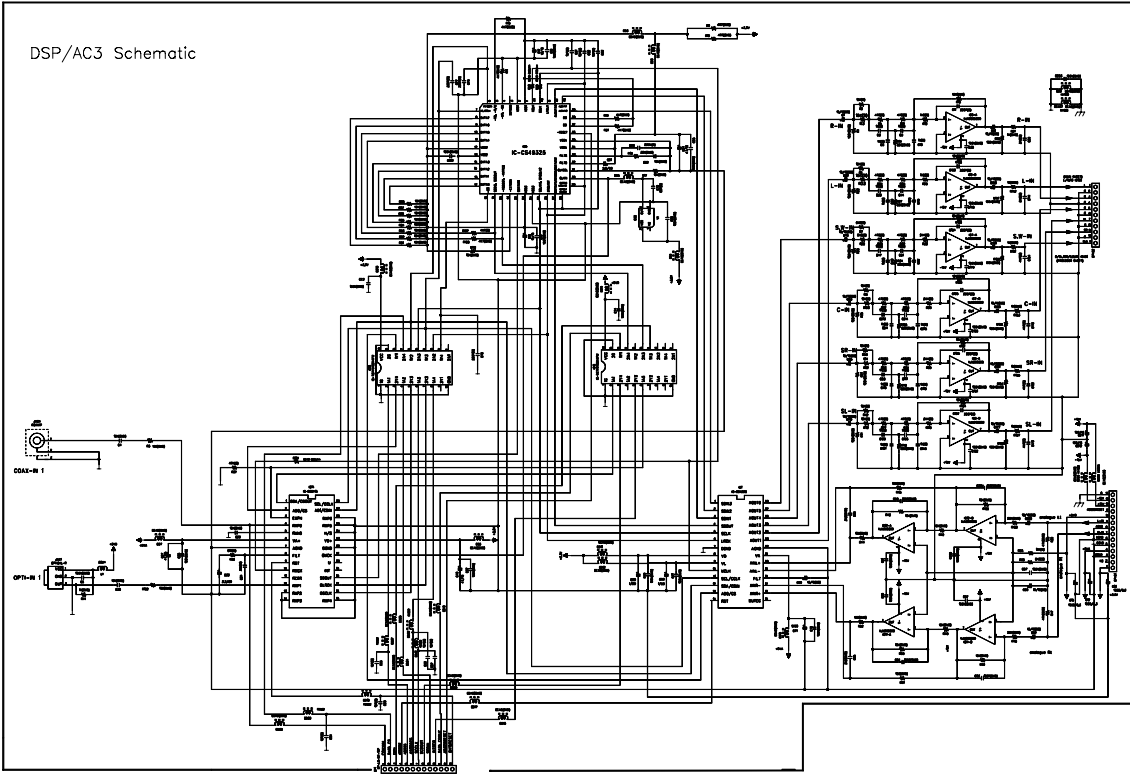

Front Inputs

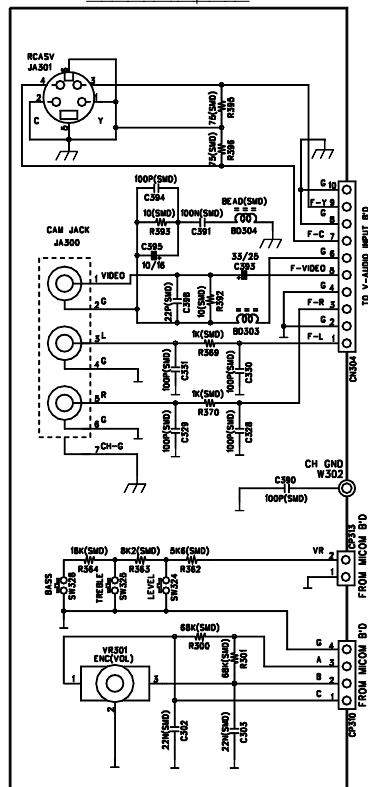

Headphone PCB

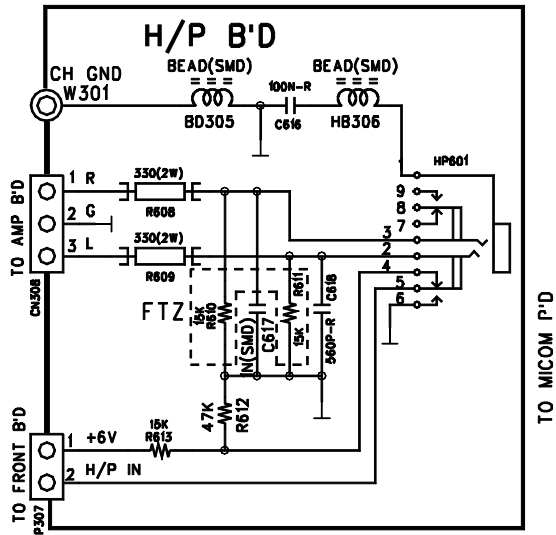

RT2280 KEYPAD

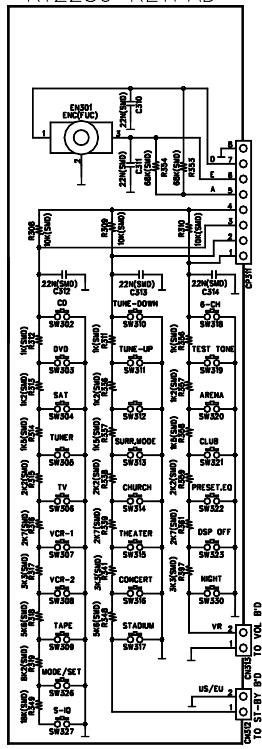

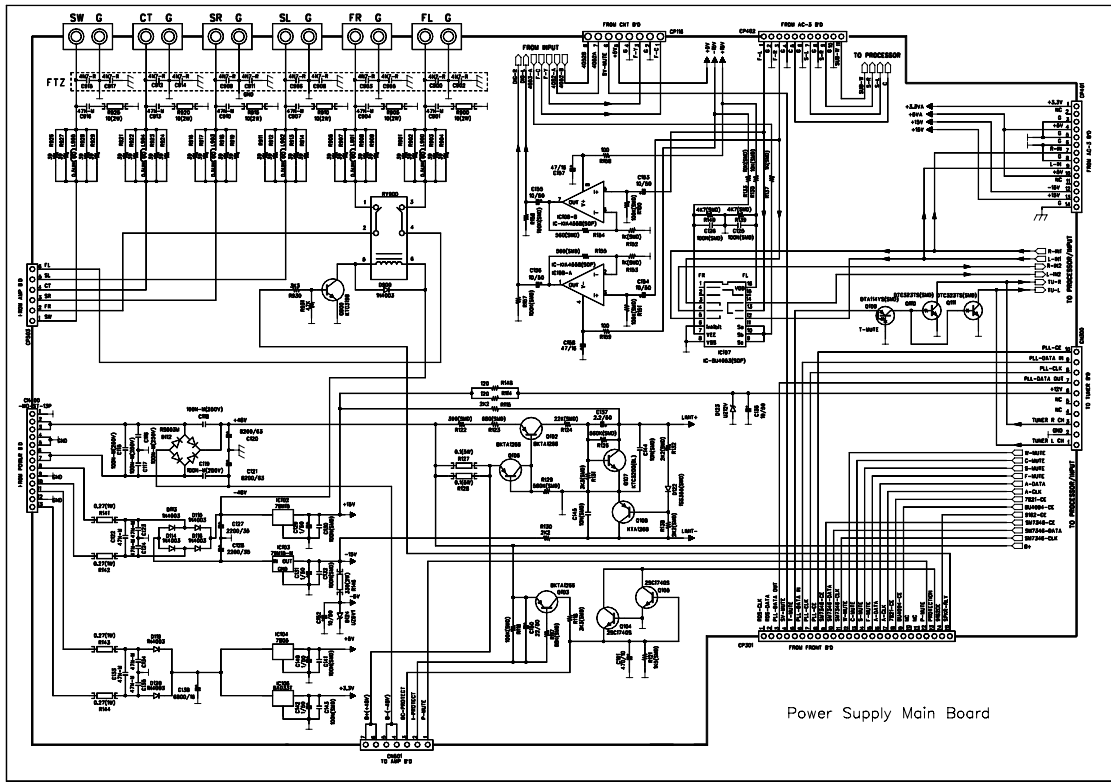

Power Supply Main Board

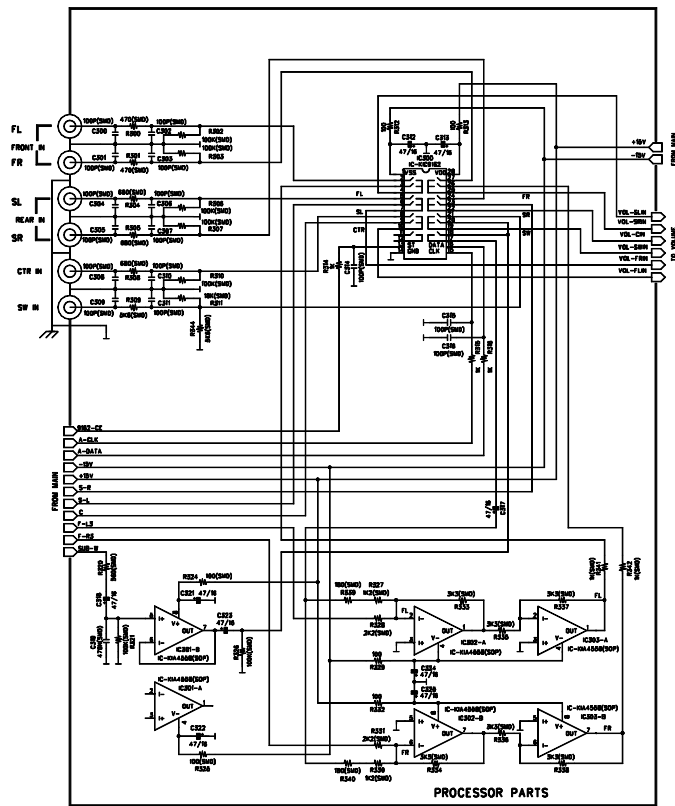

Standby-LED Board

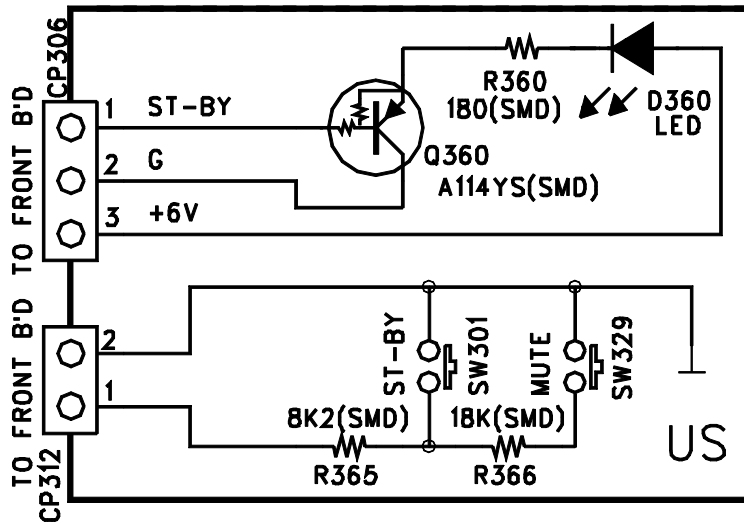

SCHEMATIC DIAGRAM

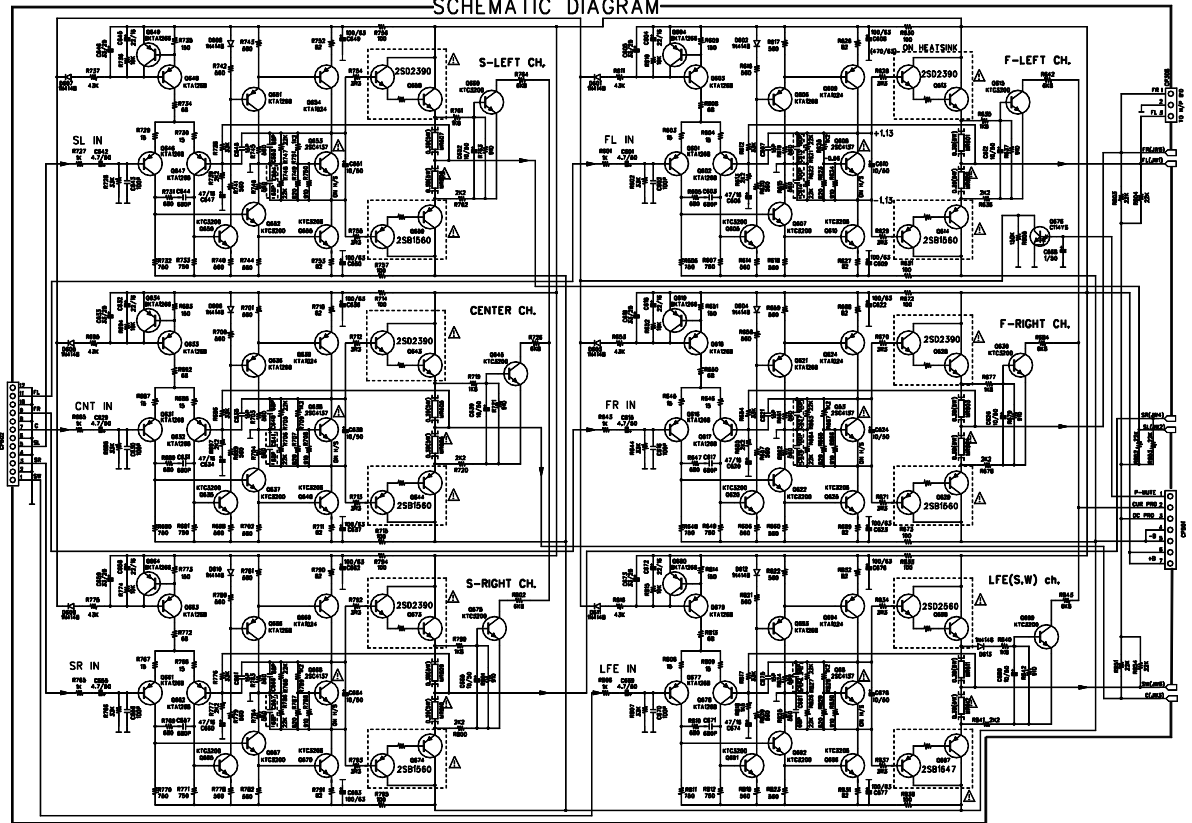

RT2280 Power Supply

