

THORENS

The Accent is on Quality

SERVICE MANUAL

MODELS: TD-145 Series I
TD-160 Series I
TD-165 Series I

TD-145 MKII Isotrack
TD-160 MKII Isotrack
TD-166 MKII Isotrack

CONTENTS

Important Instructions	1.
Directions for Ordering Parts	1.
Hum Modifications	5.
50/60 Hz and 110/220 VAC Conversion	6.
TD-145,TD-145MKII Electronic Cueing	8.
Production Changes	11.
Exploded View Drawings	
Top Chassis Parts	12.
Bottom Chassis Parts	17.
TD-145,TD-145MKII Cam/Lever Assembly	18.
TD-145,TD-145MKII Electronic Switch Assembly	19.
TP-11 Series I Tone Arm	20.
TP-16 Series I Tone Arm	21.
TP-11 MKII Tone Arm	22.
TP-16 MKII,TP-16 MKIII Tone Arm	23.

IMPORTANT

CAUTION NOTICE:

The service procedures described are intended for the information of QUALIFIED ELECTRONIC SERVICE TECHNICIANS

Exposure to HAZARDOUS VOLTAGES may be involved in some of the service procedures described. The unit under repair should be disconnected from the LINE VOLTAGE before proceeding with any service adjustments involved that require the bottom cover to be removed.

All service requiring the removal of the bottom cover should be referred to QUALIFIED SERVICE PERSONNEL

EPICURE PRODUCTS INC and THORENS disclaim any responsibility for personal injury or damage for failure to observe this warning.

DIRECTIONS FOR ORDERING PARTS

1. Use the part numbers as they appear next to the part on the exploded view drawings.
2. Specify the model and serial number of the THORENS unit the part is required for.
3. Refer to the factory production changes. Some parts may differ and the serial number information will assist us in identifying and delivering the correct replacement part.
4. Some parts as seen in the exploded view drawings are not available separately as shown and are only available with other associated parts due to special tools and gauges required for the assembly. Wherever necessary, the minimum assembly will be shipped in place of the part ordered.

RUBBER BELT #TD-574

Examine the rubber belt by stretching it. If cracks appear in the rubber, the belt is dried out and should be replaced. Before replacing the belt, examine the surface of the motor pulley and the outer skirt of the inner turntable for traces of rubber deposits. Clean these surfaces with a soft cloth saturated in denatured alcohol and replace the belt. If the belt makes a slapping noise, too much moisture in the belt may be the cause. Dust the fingers lightly with talcum powder and pass the belt through the powder to dry it or absorb the moisture.

MOTOR AZIMUTH

If upon starting, stopping or interrupting the turntable rotation the rubber belt rides up or down and slips off the motor pulley, the motor azimuth may require adjustment.

The motor azimuth adjustment brings the axis of the motor pulley in parallel alignment with the axis of the inner turntable platter. To correct the motor azimuth rotate the azimuth screw (arrow). This adjustment is sealed by the factory with a dab of fast drying paint to secure the adjustment.

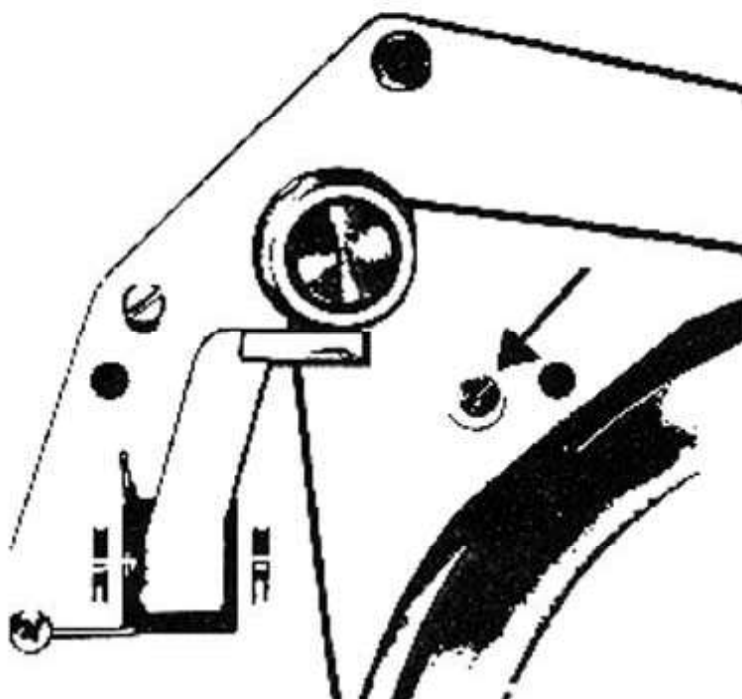

If the rubber belt rides up on the motor pulley rotate the azimuth screw counterclockwise.

If the rubber belt rides down the motor pulley rotate the azimuth screw clockwise.

Once the azimuth adjustment has been set reseal the screw with a dab of nail polish or fast drying paint.

To achieve the optimum isolation for both cases a relocation of the turntable or speakers or both in the room may be necessary to remove the turntable from the direct or indirect (reflected) radiation of the loudspeakers.

Placement of the turntable in the corner of a room where the inter-connection of walls, floor and ceiling is structurally stronger will in most cases reduce the possibility of floor vibrations disturbing the turntable. If additional isolation is required from floor vibrations cotton wadding may be inserted into the coils of the three cone shaped chassis suspension springs. Small quantities should be tried first in each of the three springs and the results tested. If additional cotton wadding is required it may be added until satisfactory results are obtained.

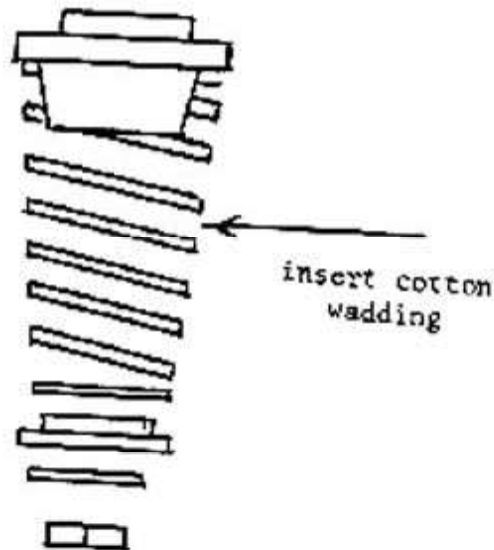

ON-OFF SWITCH

If the unit fails to operate, remove the AC cord from power and check the switch operation with an Ohmmeter while actuating the switch lever by hand. The speed selector knob should be in one of the "ON" (speed) positions. If the switch makes continuity but the actuating lever movement is insufficient to actuate the switch, loosen the screws securing the switch and adjust the switch position relative to the actuating cam.

The switch adjustment procedure should also be followed if the unit fails to shut off. The 0.01mFd capacitor should also be tested for a short.

If a 'popping' noise occurs in the speakers when the on-off switch is operated the 0.01mFd capacitor may be open and should be replaced.

The tone arm wiring systems of the THORENS models employ a method whereby the right channel ground (outer shield conductor) is connected to chassis ground at the terminal strip junction of the tone arm wires and audio cable. With some combination of components, pick-up cartridge and preamplifier it may be necessary to disconnect the right channel ground and audio output cable outer shield connection from the chassis ground to minimize hum pick up via ground loops. A separate turntable chassis to preamplifier chassis ground may also be necessary.

Models; TD-145, TD-145MKII, TD-160CMKII, TD-166MKII

1. Remove the metalized plastic shield covering the lower tone arm pivot assembly.
2. Unsolder the gold wire from the terminal strip.
3. Remove screw "A" and unsolder the ground lug from the terminal strip.
4. Remove the terminal strip from the locating slots and apply a small piece of masking or electrical tape over the exposed portion of the terminal strip to which the green wire is connected.
5. Insert the terminal strip into the slots.
6. Secure the ground lug to the block with screw "A" and resolder the gold wire and separate chassis ground wire to the ground lug. Make certain the solder tab is turned away from the terminal strip to prevent an accidental short to the green wire terminal.
7. Replace the metal shield.

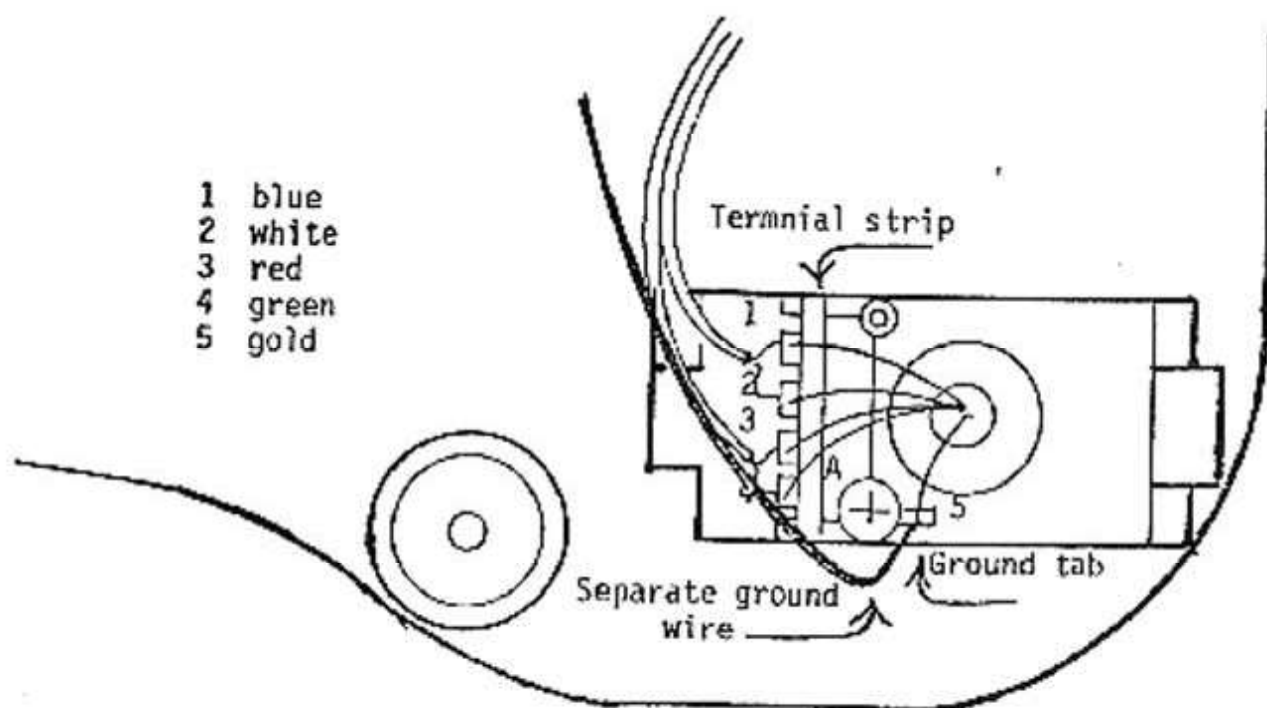

Models; TD-160C Series I, SN 229500 and below
 TD-165, SN 104600 and below

Unsolder the metal tab at the terminal block and connect a separate ground wire from the turntable chassis at the metal tab to the preamplifier chassis.

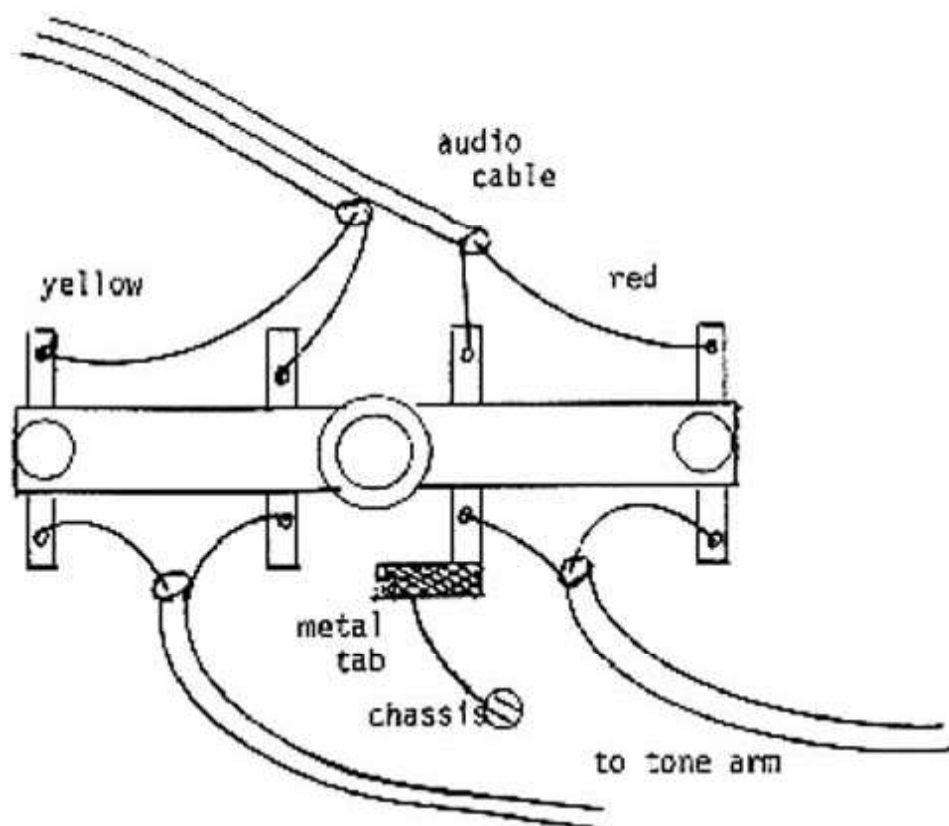

50/60 HZ-110/220 VAC CONVERSION

THORENS turntable sold in the USA or Canada are set at the factory for 110VAC/60Hz operation.

Conversion to 50Hz/220VAC operation requires a motor wiring change and replacement of the motor pulley.

SPECIAL NOTE-TD-165 only; The motor pulley is affixed to the motor shaft with a special epoxy cement. Attempts to remove the pulley will result in excessive stress on the motor shaft which will cause it to bend. For change of operation to an alternate frequency should be accomplished by replacement of the complete motor and pulley assembly.

FREQUENCY CHANGE

Press down on top of the motor pulley and washer. Remove the retaining clip and release the pressure on the motor pulley slowly so the internal clutch spring does not cause the parts to fly off. Later productions use a metal ring on top with set screws that may be loosened with a screwdriver or hex wrench.

order the correct motor pulley replacement as follows;

50Hz operation	7.866.007
60Hz operation	7.866.001

VOLTAGE CHANGE

CAUTION: DISCONNECT THE UNIT FROM LINE VOLTAGE BEFORE ATTEMPTING THESE CONVERSION PROCEDURES.

TD-160,TD-165,TD-166 only

Remove the hardboard bottom cover held in place by four screws at the corners of the base.
Remove the single screw securing the plastic cover over the terminal strip.

110VAC; Connect the AC line cord to terminals B and E

220VAC; Connect the AC line cord to terminals A and E and a 5600 Ohm/5 Watt resistor to Terminals A and B.

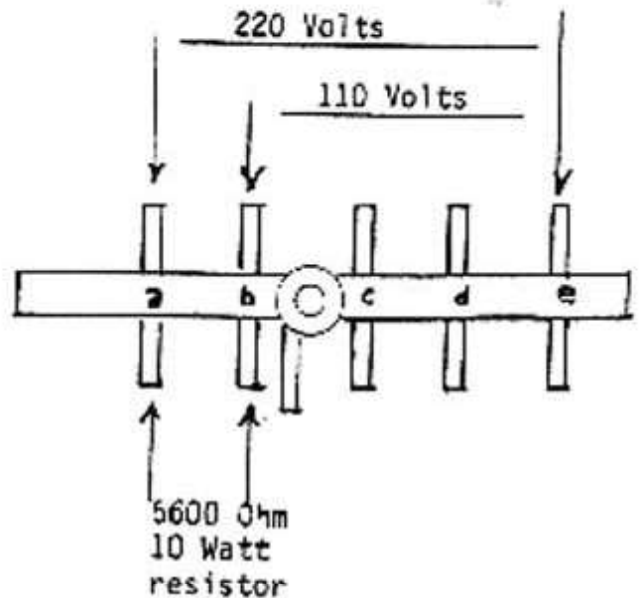

SCHEMATIC WIRING CONNECTIONS

TD-160,TD-165,TD-166 only

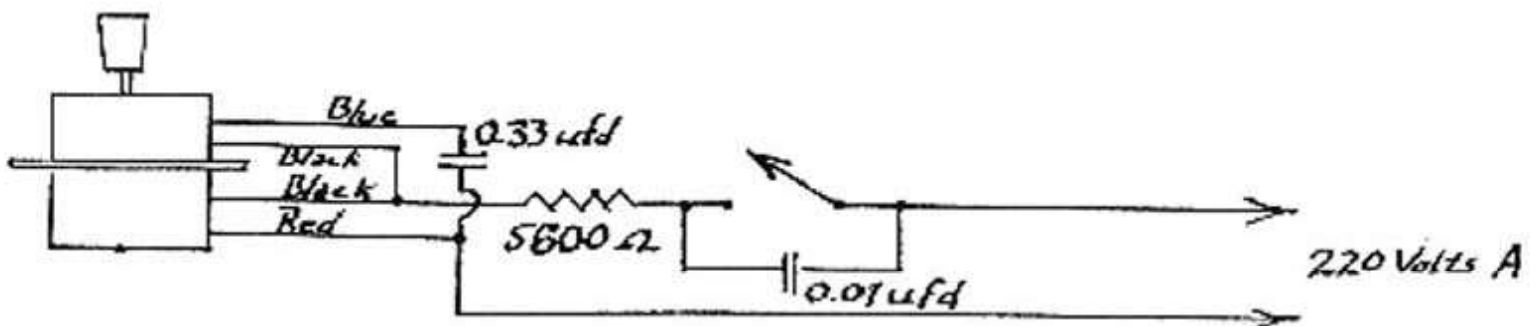
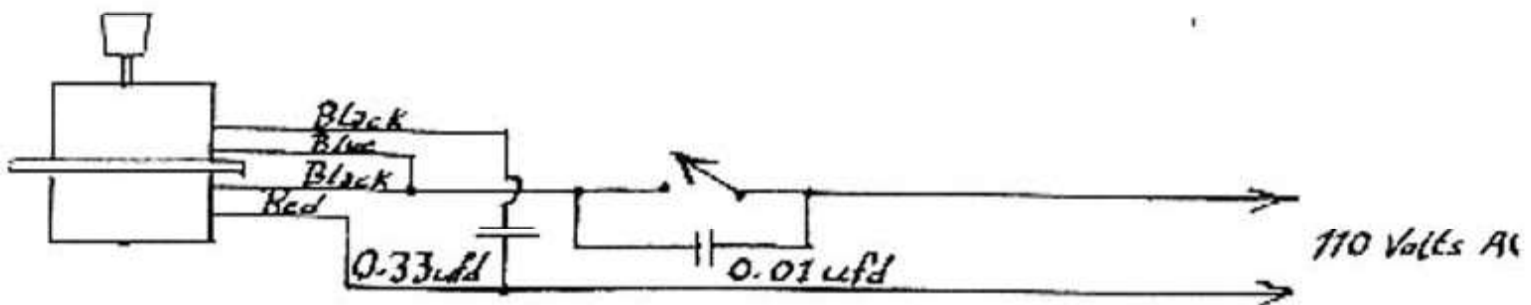

TD-145, TD-145MKII only

For 110VAC operation move the AC cord wire from connector 5 to connector 4 and the looped wire on connector 2 to connector 5.

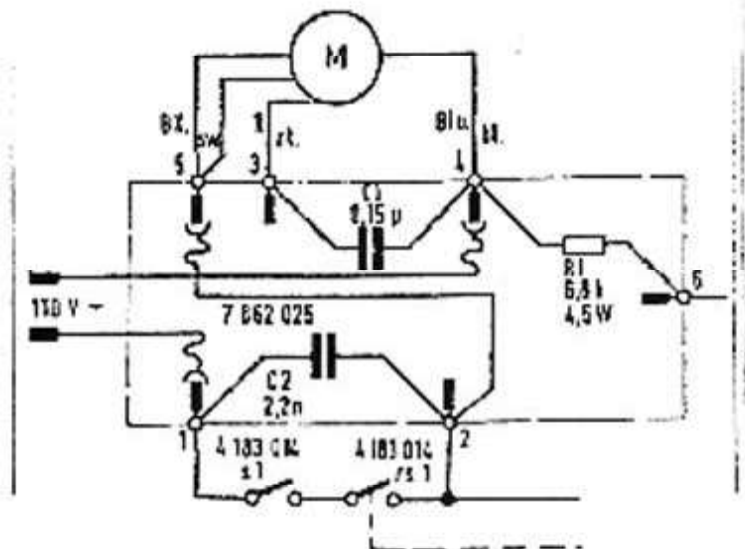
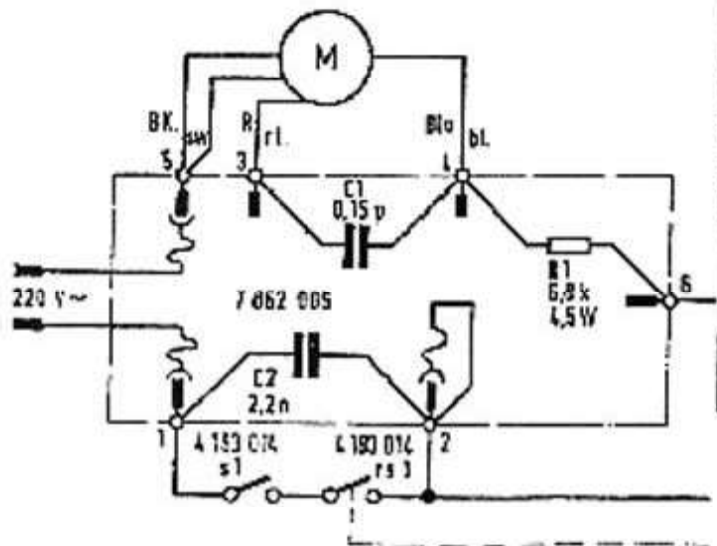

II. ELECTRONIC CUEING/SHUT OFF (TD-145, TD-145MKII only)

DESCRIPTION OF OPERATION

When the turntable speed has been selected S-1 will be closed. When the speed selection control is rotated, past the selection against the spring pressure, the armature of relay RS-1, thus energizing the synchronous motor M and the electronics circuitry via R1 and the bridge rectifier Gr-101 and hence relay RS-1, since S-2 is closed. When the tonearm is lowered, switch S-2 opens.

Transistor T-101 with L-101, C-102 and C-103 form a high frequency oscillator at a frequency of 80kHz. T-102 along with L1 and C2 form a buffer amplifier with part of the inductance determining core mounted on the base of the tone arm, As the tone arm is rotated, the inductance of L1 changes, bringing the circuit closer to resonance and the RF voltage at the collector of T-102 (point B) increases. Diodes D-101, D-102 and capacitor C-106 form a rectifier and voltage doubling circuit. T-103 is a DC amplifier feeding the differentiating circuit associated with T-104 producing a negative pulse at the collector of T-104 (point C).

Transistor T-105 and T-106 form an emitter coupled bistable switch which has the initial state of T-105 switched on and T-106 off. When a negative pulse appears at point C, transistor T-105 is switched off, T-106 switches on and relay RS-1 is de-energized, opening contacts RS-1, stopping the motor, raising the tone arm and disconnecting supply to the electronic circuitry.

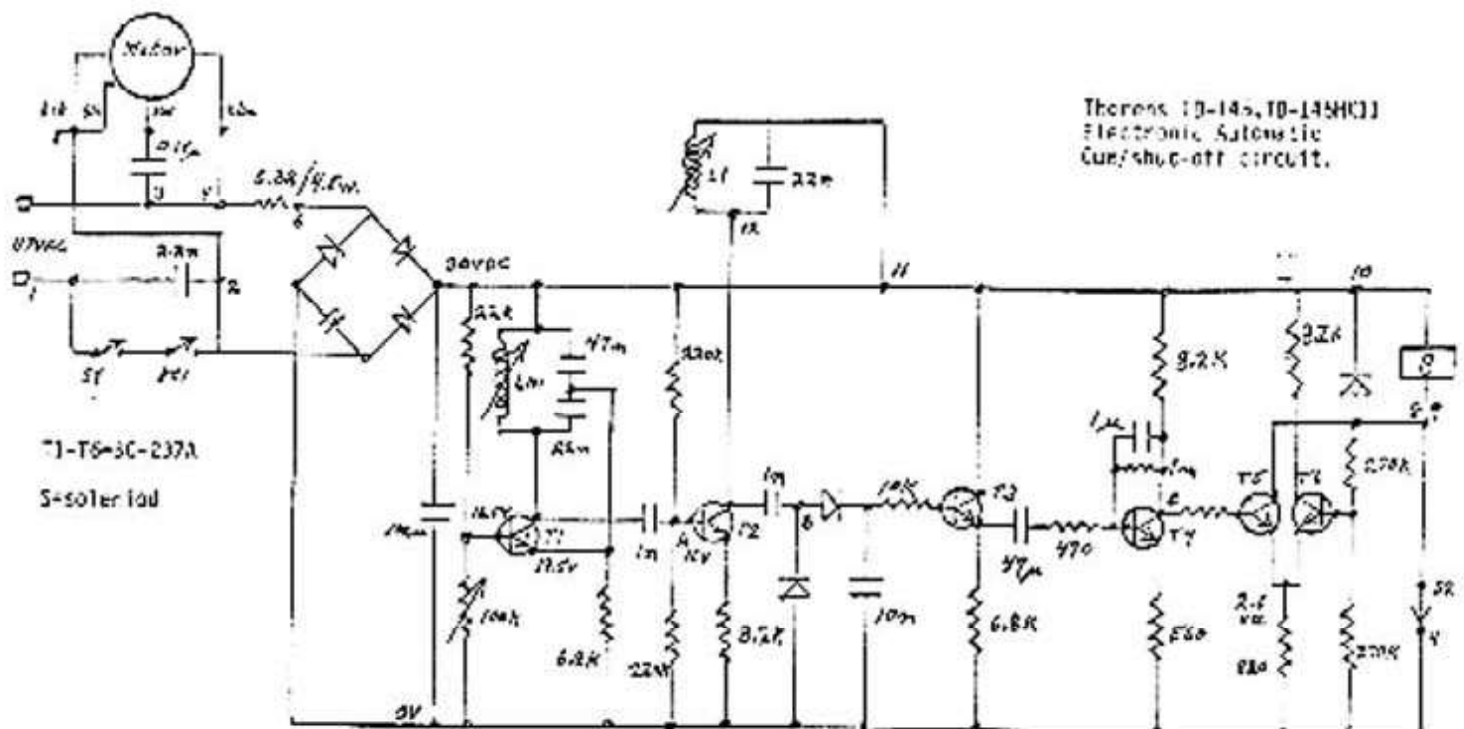

SERVICE ADJUSTMENTS

Switch adjustments; If it becomes necessary to adjust the switches, there is a defined value of clearance associated with each function switch.

Remove the hardboard bottom cover. The micro switch S-1 associated with the speed selection control must have a clearance of 0.8mm between the actuating arm and the body of the switch when the speed selection control is in the "STOP" position.



SERVICE ADJUSTMENTS (TD-145)

The micro switch RS-1 associated with the lowering of the tone arm must be adjusted such that the rubber band around the end of the actuating arm of the solenoid, when in the released position, just touches the body of the switch.

The contacts S-2 that are operated by the cam mechanism of the tone arm lowering switch must be adjusted such that the distance between the contacts is within the range of from 0.5 to 1.0mm when the tone arm is lowered.

All switches can be adjusted by loosening their mounting screws.

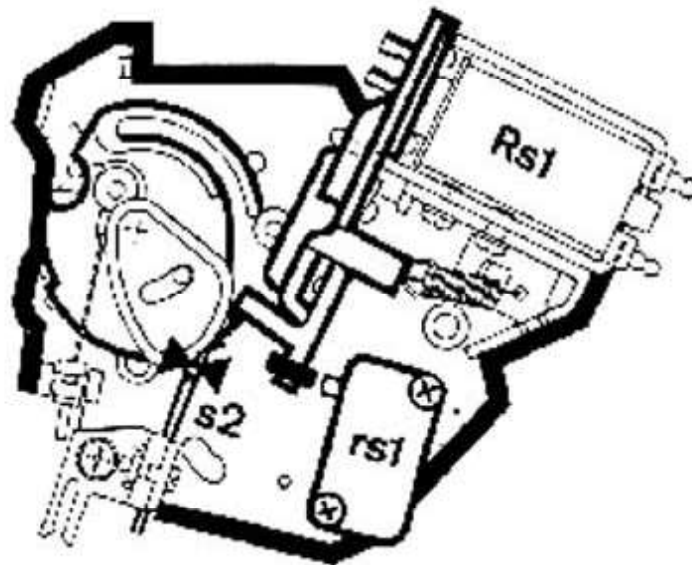

CUEING INDUCTANCE ADJUSTMENT

Remove the plastic cover at the bottom of the tone arm. Mounted on a plastic support is the cueing inductance. Loosen the screw of the plastic support and slide the inductance assembly to obtain a clearance of 0.4mm between the core of the inductance and the ceramic disc mounted at the bottom of the tone arm.

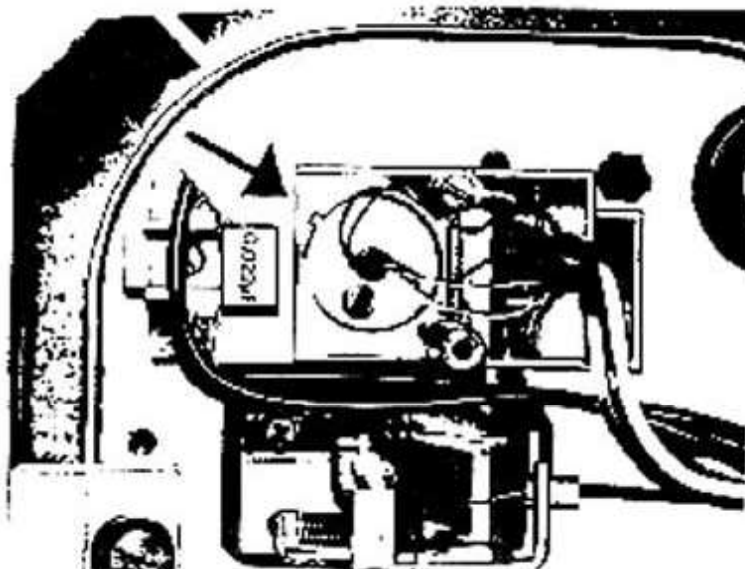

SERVICE ADJUSTMENTS (TD-145)

ELECTRONIC ADJUSTMENTS

With 22VAC applied between point 2 and 6 check that the DC voltage appearing across C-101 is 30 Volts $\pm 10\%$.

Connect a frequency counter with a low input capacitance to point "A" and adjust the inductance L-101 such that the oscillator frequency is approximately 80kHz by rotating the ferrite core with a non-metallic tool.

With an AC Voltmeter connected to point "B" adjust R-101 carefully to obtain a value of 2.0 Volts ± 0.1 Volts.

If this value cannot be obtained readjust the ferrite pole as described above.

Rotate the core of L-101 in a clockwise direction to obtain a decrease in voltage at point "B" by 0.2 Volts, i.e. measure a value of 1.8 ± 0.1 Volts.

To ensure that the oscillator has been detuned in the correct direction, move the tone arm towards the center spindle and observe that the voltage increases.

The alignment procedure is now complete. Ensure that all adjustment screws are tight and replace the plastic cover on the base of the tone arm. The auto stop process should now be checked with a record to establish that correct operation has been achieved.

PRODUCTION CHANGES

DUST COVER REPLACEMENTS

WOOD BASE REPLACEMENTS

TD-145	SN 67000 and below	TX-60	WB-160
TD-145MKII	SN all series	TX-45	WB-145
TD-160C	SN 257000 and below	TX-60	WB-160
TD-160CMKII	SN all Series	TX-45	WB-145
TD-160BCMII	SN all Series	TX-45	WB-145
TD-160 SUPER	SN all Series	TX-60S	WB-160S
TD-165	SN-131700	TX-60	WB-160
TD-166MKII	SN all Series	TX-45	WB-145

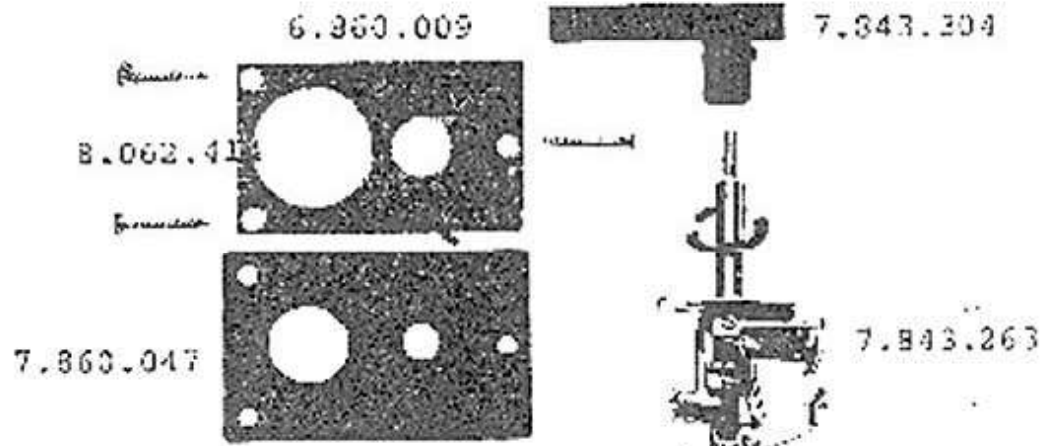

6.900.500

6.855.793

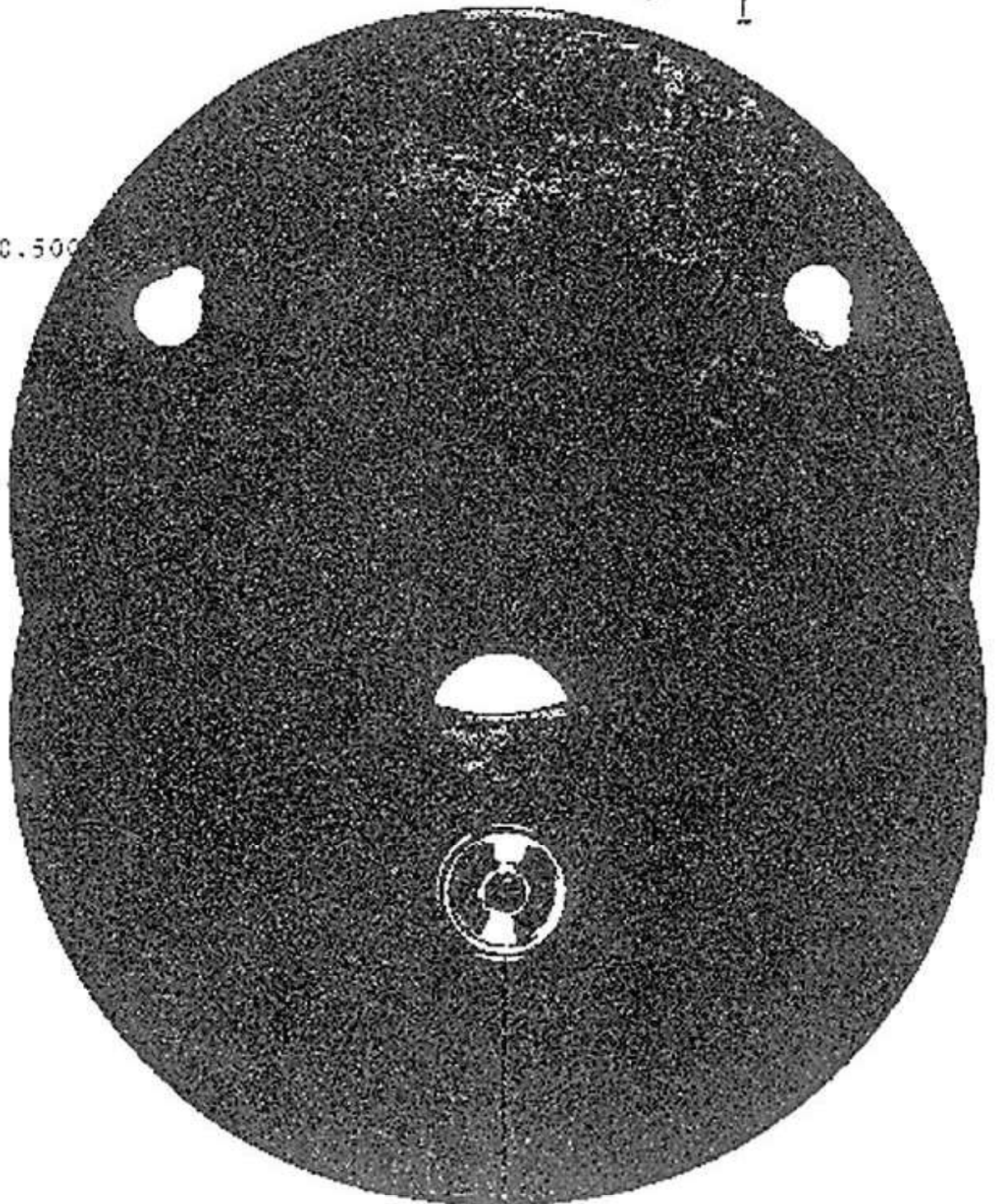

6.861.020

7.863.003

7.860.005

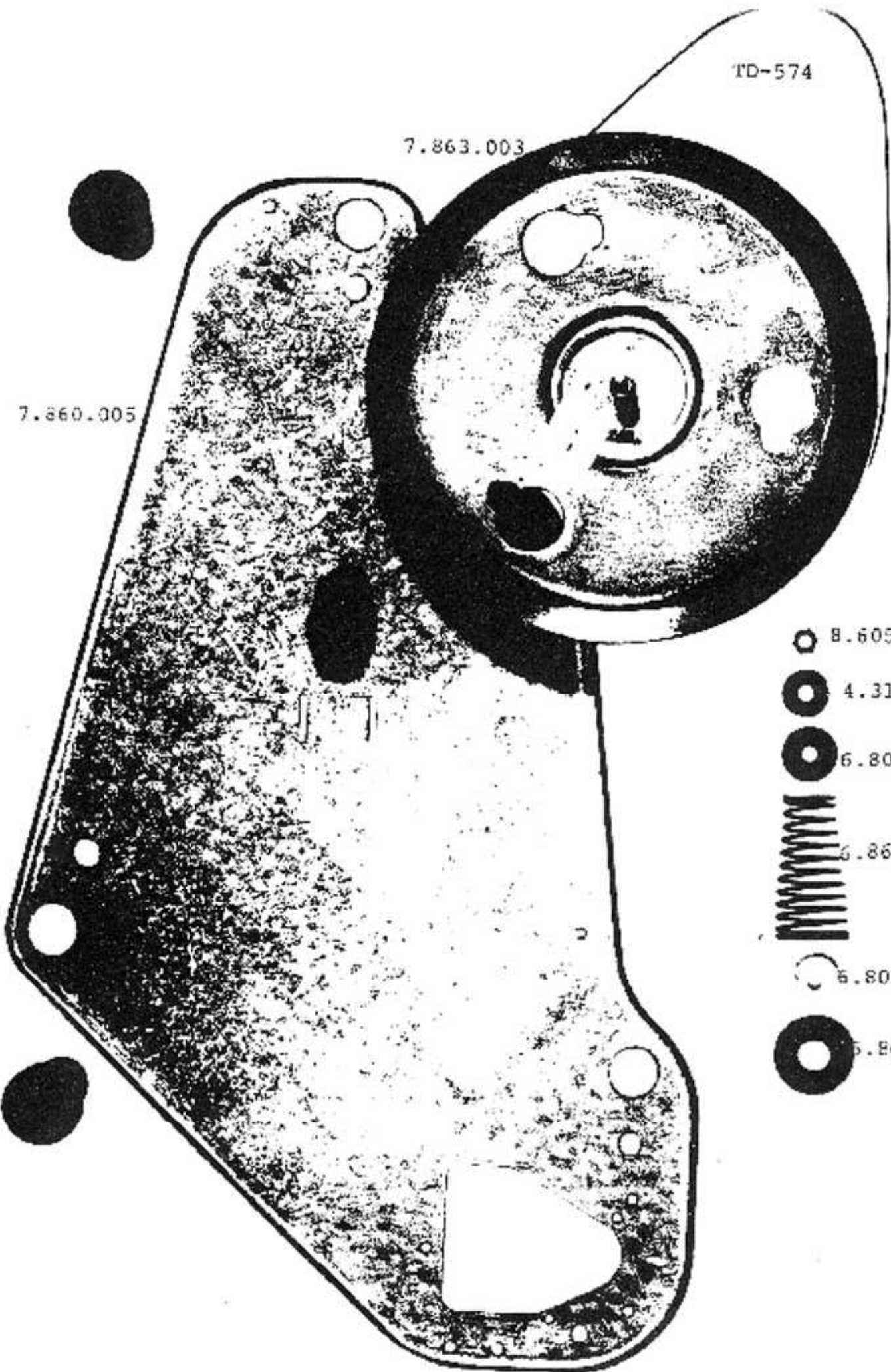

8.605.113

4.312.157

6.800.568

6.861.020

6.800.561

5.867.002

6.860.019

6.867.001 (MKII)
6.860.010 (SER.I)



THORENS

Top Deck Plates

TD-145Ser.I	6.862.029
TD-145MKII	6.867.000
TD-160SER.I	6.860.012
TD-160CMKII	6.868.000
TD-160BCMII	6.869.000
TD-165.	6.861.022
TD-166MKII	6.868.004

4.312.223

8.061.036

4.261.007

312.217

6.860.019

78.053.164

6.861.034

TO
MINI

4.321.025



4.312.195

8.605.113

8.008.153

6.855.077

7.860.064

(TD-165 7.861.017)

6.862.003

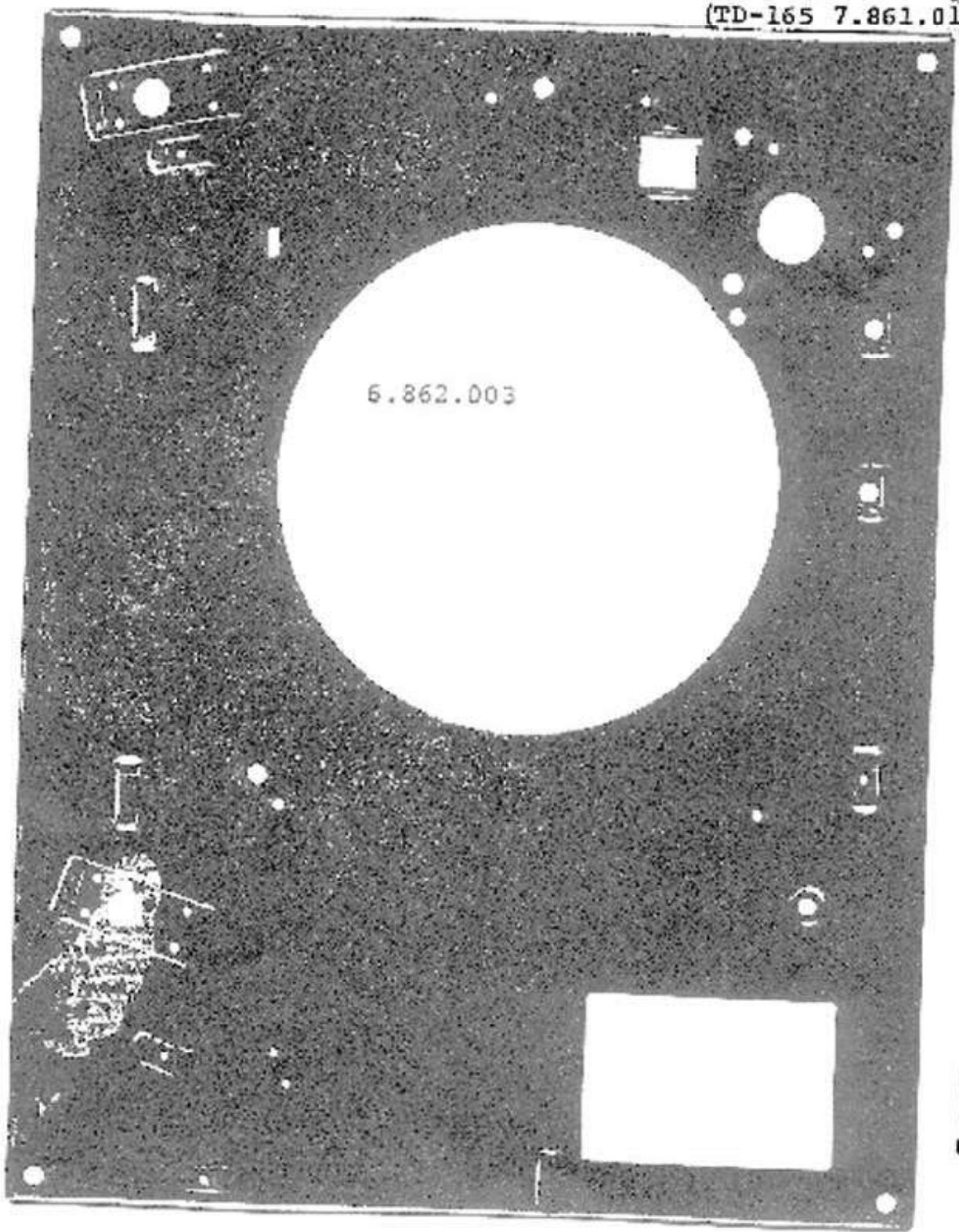

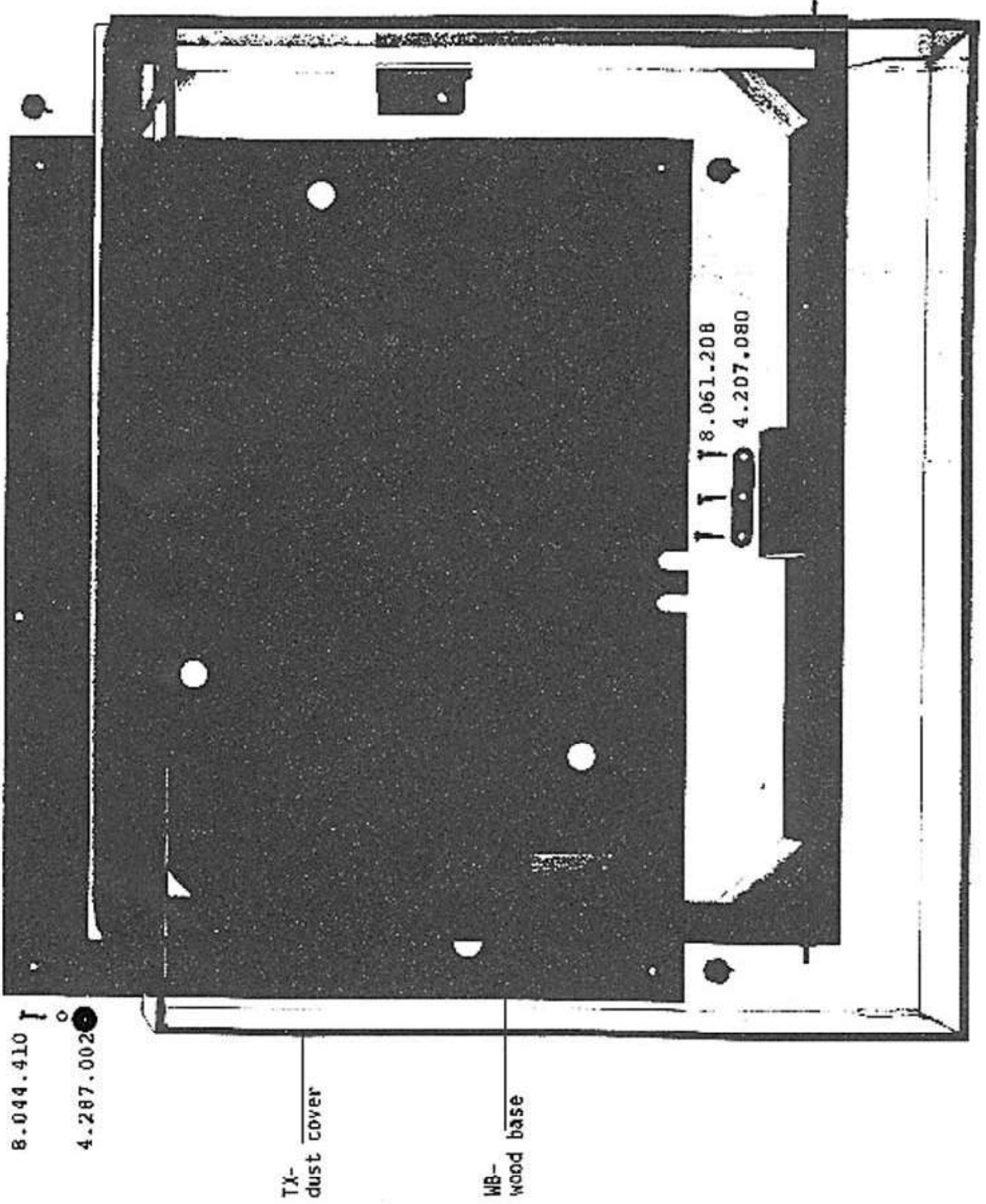

8.044.410
4.287.002

TX-
dust cover

WB-
wood base

8.061.208
4.207.080

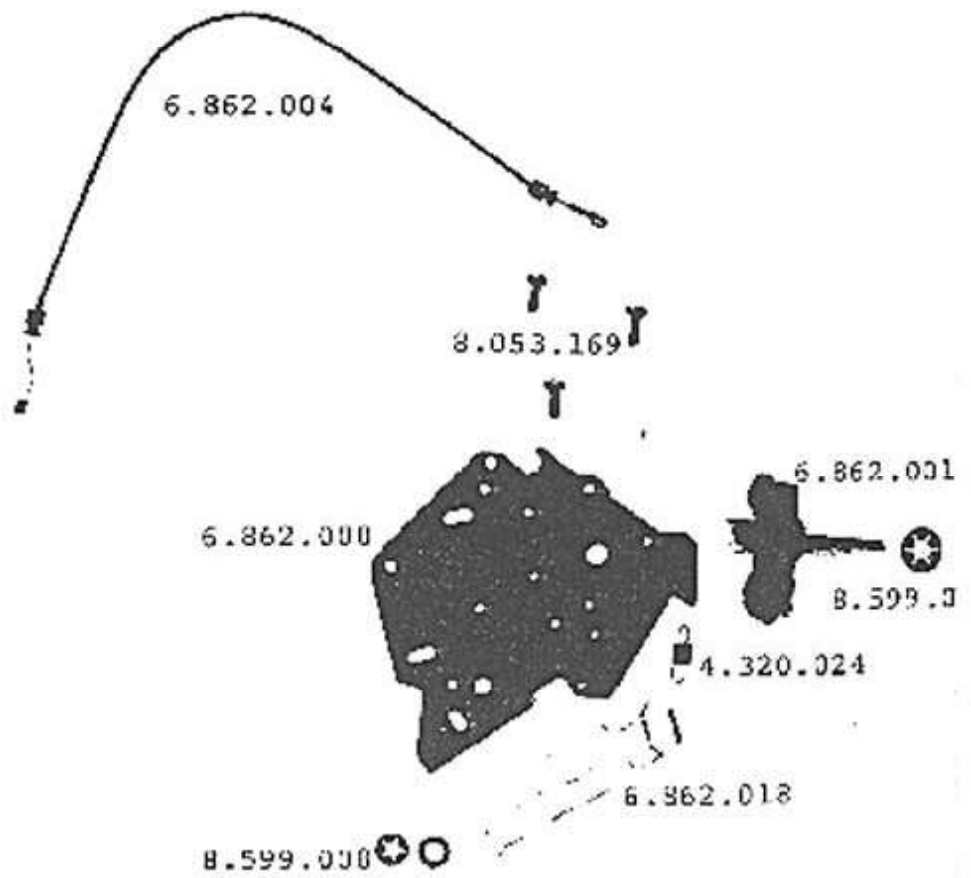
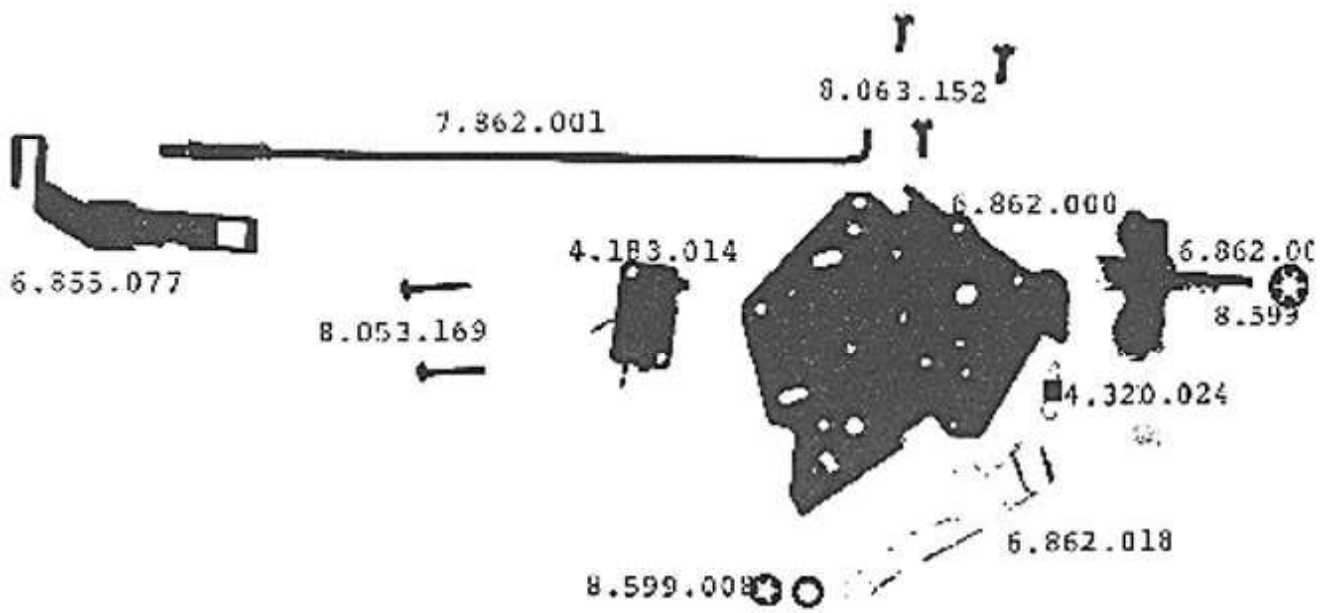

TD-145,TD-145MKII Can/lever assembly

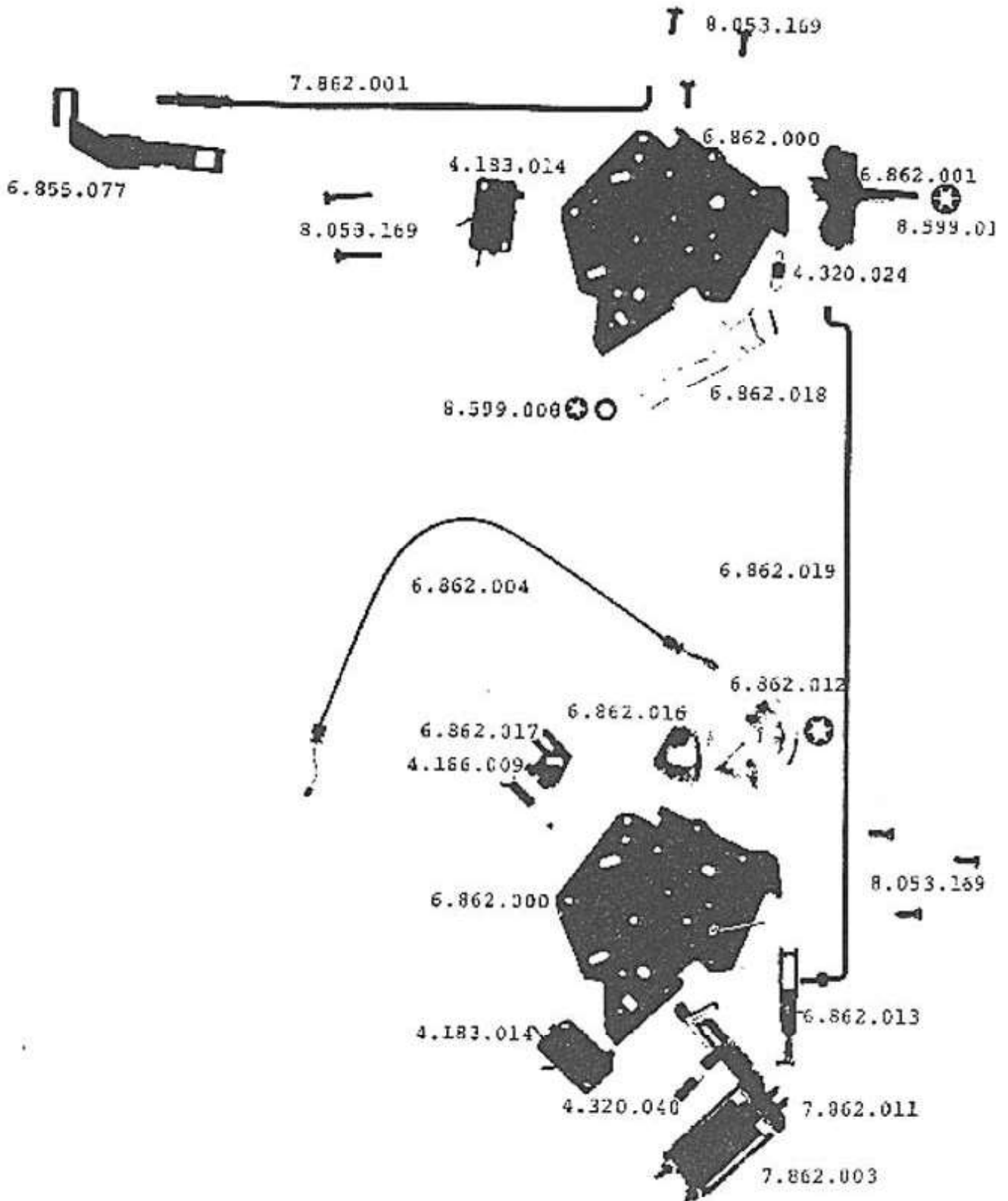

TD-145, TD-145MKII
Electronic Switch
assembly.

7.862.013



6.862.023



7.862.040

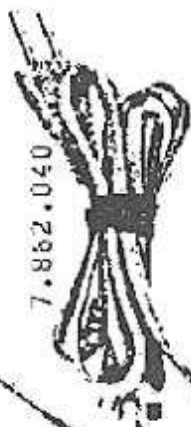

6.862.022

7.862.021



7.862.017

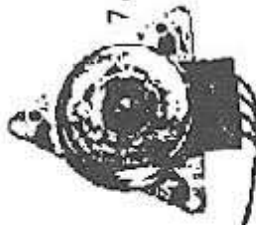

7.860.064

6.862.030

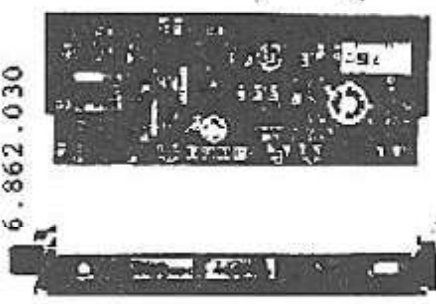

7.862.013

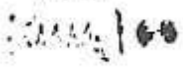

7.866.001 (60HZ)
7.866.007 (50HZ)

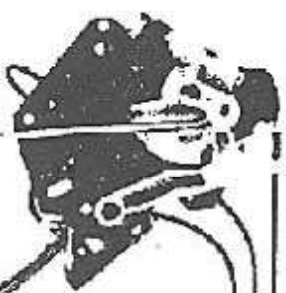

TP-11 Series I

- 7.872.032
- ▼ 6.874.008
- 7.874.010
- ⊞ 6.874.012

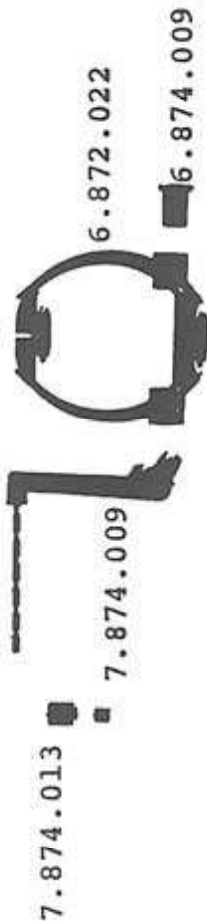

7.874.014

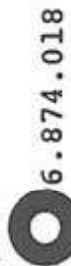

TP-16 Series I

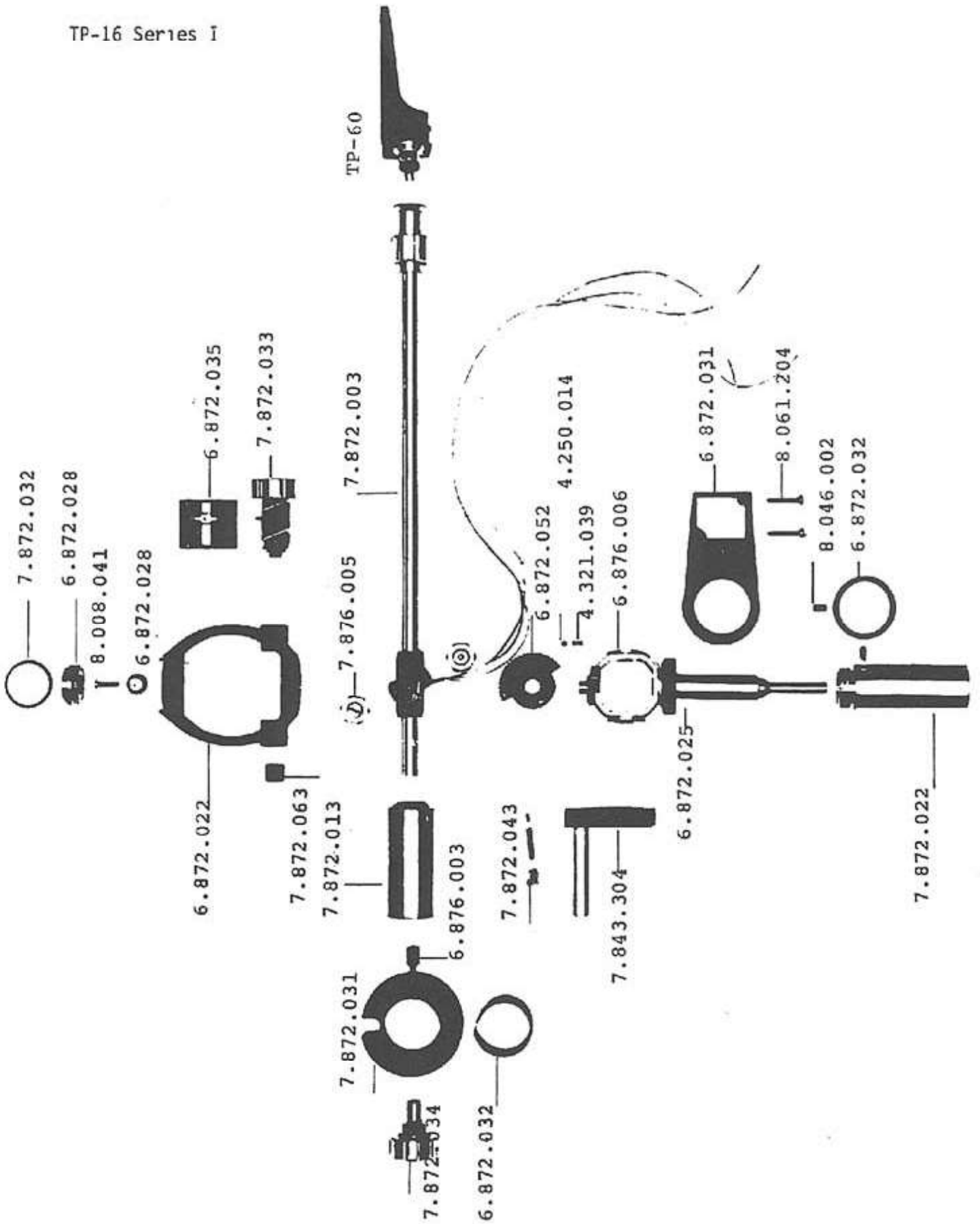

TP-11 MKII

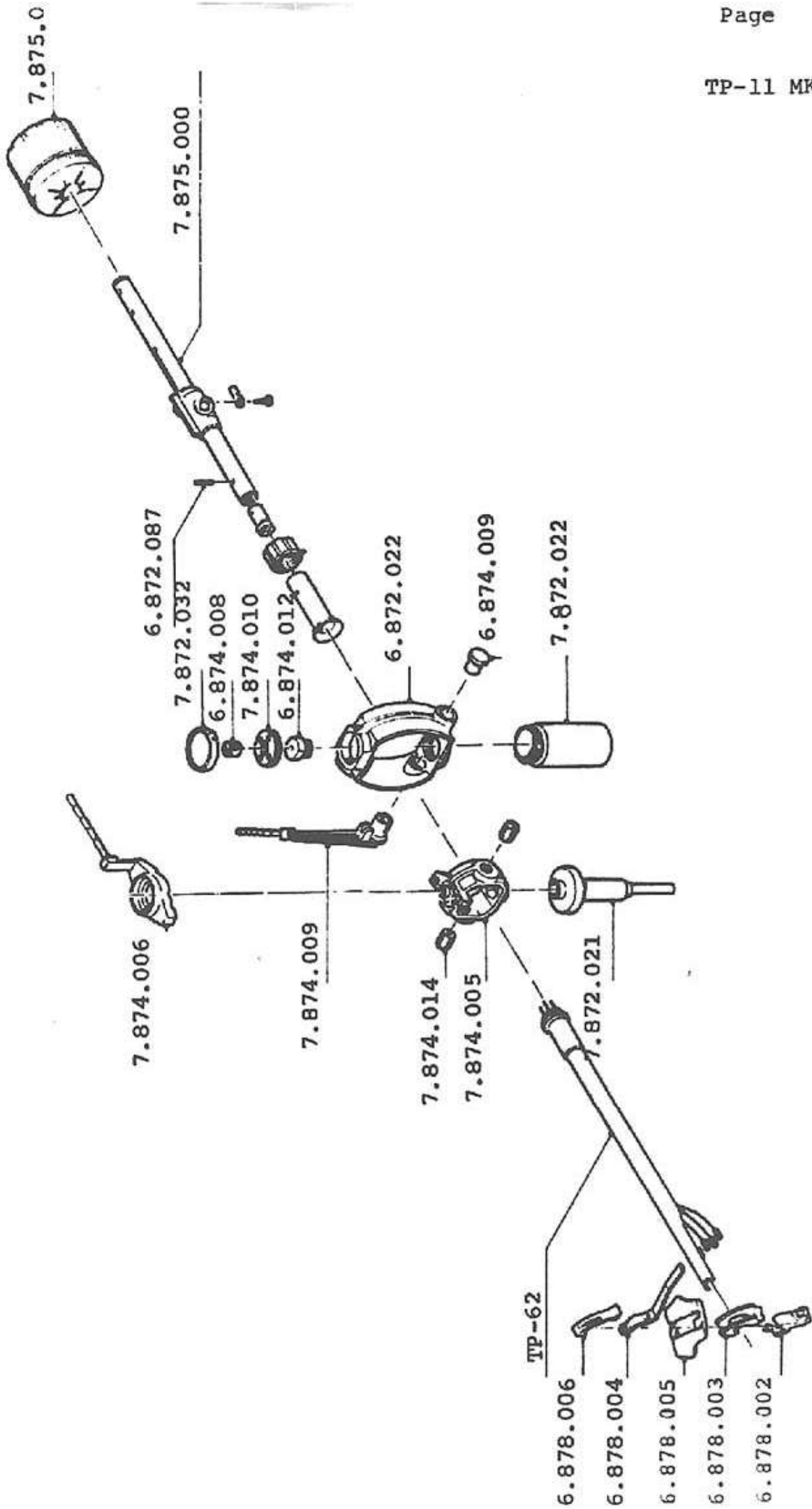

TP-16 MKII
TP-16 MKIII

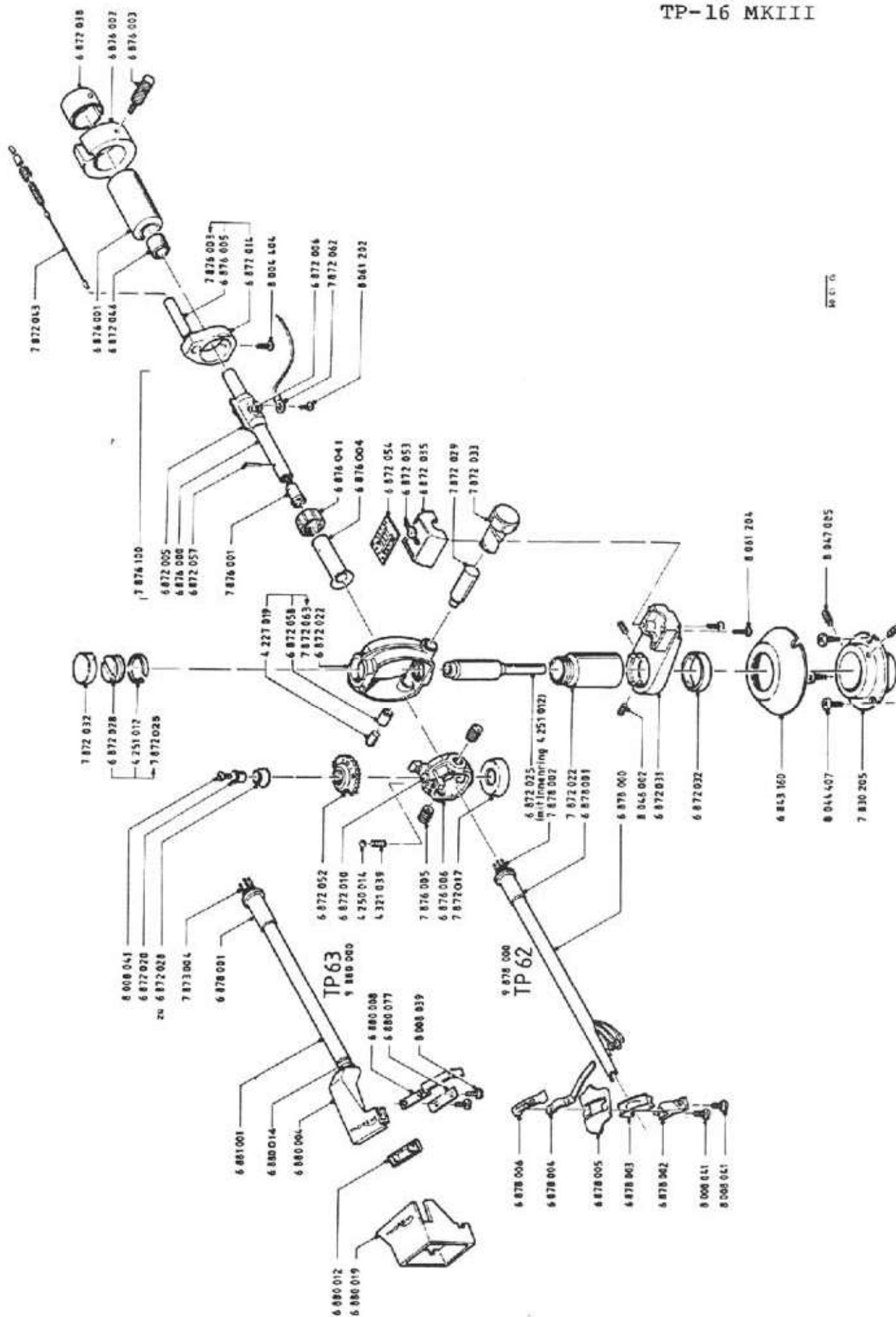

REV