

TOSHIBA

FILE NO. 400-200503

SERVICE MANUAL

 gigabeat F60 / F40 / F20 / F10

HDD AUDIO PLAYER

***MEGF60, MEGF40
MEGF20, MEGF10***
(UK)

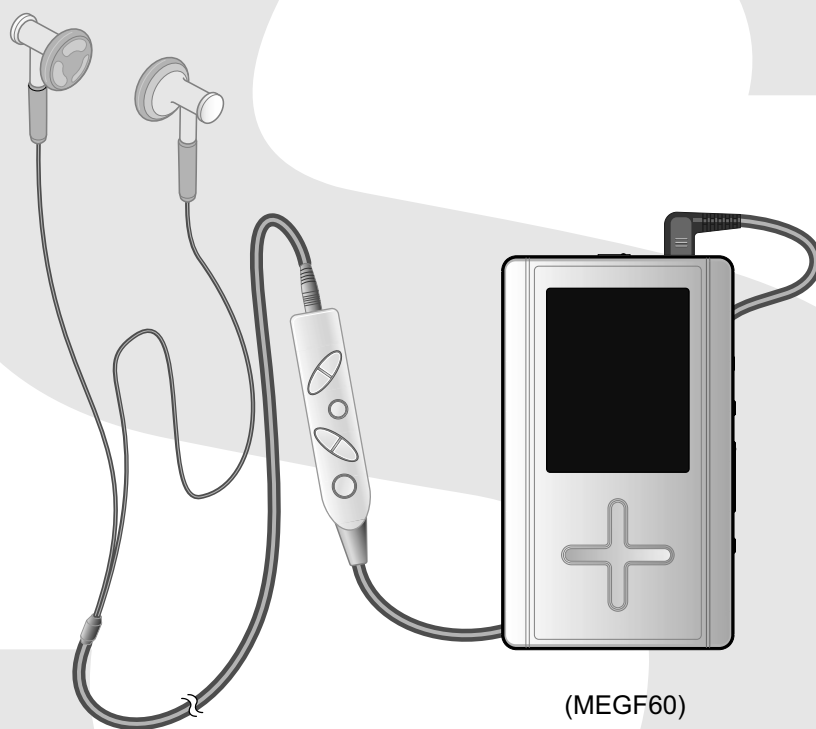



(MEGF60)

Precautions

Safety Precautions for Service

This section provides critical information for safety. Be sure to observe the content.

Meaning of each indication is as follows:

 WARNING	Death or serious injury may be caused to service personnel and/or surrounding people or users due to incorrect work by neglecting the following instructions or due to resulting defects of the product.
 CAUTION	Injury or physical damage* may be caused to service personnel and/or surrounding people or users due to incorrect work by neglecting the following instructions or due to resulting defects of the product.

* Physical damage includes damage to buildings, household goods, properties, livestock, and pets.

WARNING

<ul style="list-style-type: none"> ● Unplug the power cable before starting work (for example, disassembly) that does not need power supply. Otherwise, it may cause electric shock.
<ul style="list-style-type: none"> ● Use an insulation transformer and/or wear protective gloves when power is ON, and unplug the power cable when replacing parts to avoid electric shock.
<ul style="list-style-type: none"> ● Use specified spare parts of the product for replacement. Since some parts have safety characteristics (fire resistance, withstand voltage, etc.), use replacement parts with same characteristics. For safety-sensitive parts specified by marking in circuit diagrams or parts lists, use specified parts.
<ul style="list-style-type: none"> ● After repair work is completed, properly reassemble disassembled parts and securely reconnect cables as they were. For safety reasons, some insulating materials such as tubes and tapes are used, and some parts are mounted with a gap from the board surface. Furthermore, internal wiring is kept away from heating parts or high-voltage parts by using claspers or by other means. When reassembling/reconnecting these parts, put them as they were. Do not catch the internal cables by the cabinet or cover. Improper assembling or cable connection may cause electric leak or fire, which may lead to an accident on the user side.
<ul style="list-style-type: none"> ● After repair work is completed, unplug the power cable, and measure the insulation resistance between the external metal portion and plug blade with a 500V megger. The resistance shall be 1M ohms or more. If the resistance is lower than 1M ohms, inspect and rectify the product.
<ul style="list-style-type: none"> ● Do not alter the product. Alteration of the product may cause malfunction or failures, which may lead to an accident such as electric leak or fire on the user side.
<ul style="list-style-type: none"> ● Advise users to keep children away from the on-site work area. Children in the work area may be injured by tools, disassembled product or parts.

Precautions for discarding built-in battery

The gigabeat uses a built-in rechargeable lithium-ion battery.

Follow the government regulations when discarding the battery.

Precautions for built-in hard disk

This product has a built-in hard disk. If the disk is subjected to impact, vibration or change in the environment, such as temperature change, it may result in damage to the unit, malfunction and/or data loss. When using this product, pay attention to the following instructions:

- Do not place the product under direct sunlight, in a closed car, near a heater or where the product will be subject to high temperatures.
- Do not place the product in a place where it will be subject to extremely low temperatures.
- Do not subject the product to sudden changes in temperature as condensation may occur.
- Do not use the product in a thunderstorm.
- Do not place the product near a magnet, speaker or other object generating a magnetic field.
- Do not place the product where it will be subject to strong vibrations.
- Do not place or drop an object on the product.
- Do not place the product where it will be exposed to water or high humidity.
- Do not place a cup or other container of liquid near the product since spilled liquid may enter the product.
- Do not subject the product to vibration or impact, or swing it around or drop it, regardless of whether or not the product is operating.
- Do not forcibly push, squeeze or twist the product.
- Do not turn off the power or disconnect the USB cable while data is being written to or read from the internal hard disk.
- Inform users that hard disk data may be lost when HDD is replaced or formatted, and advise them to back up “important data” before taking their HDDs for repair.
- Do not impact on the HDD.

An impact exceeding the specified allowable value is generated even if a vertically standing HDD falls down.

CONTENTS

1. Product overview	2
1.1. Product outline	2
2. Block diagram	5
2.1. Logic circuit block diagram	5
2.2. Power circuit block diagram	6
3. Cautions on repair	7
3.1. Tell the owner that the contents of the HDD may be erased	7
3.2. Remove the AC adaptor and set the BATTERY switch to OFF	7
3.3. When replacing the HDD	8
3.4. When replacing the main board	22
3.5. Replacing the base	24
3.6. Replacing the frame	25
3.7. Replacing the LCD and LCD backlight unit	26
3.8. Replacing the lithium - ion battery	27
3.9. Replacing the cradle	27
4. Troubleshooting	28
4.1. Anticipated defects	28
4.2. Defect analysis procedure as a maintenance service	29
5. Procedure to confirm the firmware version	36
6. About the version of firmware	36
7. Disassembling/Reassembling Procedures	37
7.1. Disassembling Procedures	38
7.2. Reassembling Procedures	42
8. Exploded view	45
9. Parts List	46
Specifications	

1. Product overview

The Toshiba HDD Audio Player gigabeat F Series is a family of portable audio players incorporating a built-in HDD of 10 to 60GB. F40 and F60 are thick because the HDD they incorporate is thick.

The main features are as follows:

- A positive touch sensor, Plus Touch™, interlocks with the Operation Guide displayed on the screen to allow you operate the unit without thinking hard.
- The unit comes with a 2.2" QVGA low-temperature polysilicon TFT color liquid crystal display. If you relate audio data with a photo in the jacket, you can select a song while looking at the photos in the jacket.
- With gigabeat room, which is software furnished with the unit, you can take in music CDs and can automatically obtain titles and artist names from the Internet, according to the CDDB.
- The HDD capacity ranges widely from 10 to 60GB.
- The unit is compatible with SRS WOW.
- A built-in lithium ion rechargeable battery enables playback for about 16 consecutive hours.
- The unit is compatible with a USB cradle, enables transfer of music CDs with a single press of the RipRec button, and also comes with a Line Out terminal.

1.1. Product outline

1.1.1. Internal composition

The gigabeat F series consists of the following main components:

- Main board
The FlashROM on the main board incorporates part of the firmware.
- HDD
It stores encrypted musical data.
The ¥GBSYSTEM folder stores firmware.
As an ordinary external HDD, this HDD can store Word and other non-musical files.
- TFT color liquid crystal display
- White LED backlight
- Battery
- Switches
Cross-type feather touch sensor
Pushbuttons and blue LED on the side
- Cabinet parts
The HDD is covered with special rubber and held in the air. This keeps it resistant to impact and vibration.

1.1.2. Accessories

The product is furnished with main accessories as follows:

- AC adaptor
This AC adaptor is compatible worldwide (with inputs 100 to 240V AC) having a 5V 3A DC output.
- Power cord (which varies with destinations)
- USB cradle
Placing the unit on the cradle will start recharging.
The cradle has a USB Mini-B connector and can connect the unit to a PC.
It has a Line Out terminal (3.5mm dia. stereo jack).
It comes with a USB and a Line Out switch.
It has a RipRec and a Sync button.
- USB cable
The cable is designed for fast data transfer with USB 2.0.
- Wired remote controller (optional for some models)
It is connected to the headphone terminal of the unit. The remote controller comes with a headphone terminal, which receives a pair of headphones.
- Headphones (whose cord length and plug type vary according to whether there is a wired remote controller)
It is a pair of inner-ear type 16Ω stereo headphones. The models furnished with the wired remote controller have a short cord and a straight plug. The models not furnished with a wired remote controller have a long cord and a right-angles plug.
- Software CD-ROM
This software runs on a PC, including TOSHIBA gigabeat room.
- Owner's manual

1.1.3. Place for storing firmware

Firmware is stored on FlashROM and HDD on the main board. The ¥GBSYSTEM folder on the HDD stores the firmware. The ¥GBSYSTEM folder comes with the SYSTEM and HIDDEN attributes. Connecting it therefore does not allow it to be seen on the Explorer. However, reconfiguring the Explorer will enable it to be displayed.

In case the user deletes the ¥GBSYSTEM folder by mistake, the gigabeat room creates a backup copy of the ¥GBSYSTEM folder in the PC the first time the gigabeat is connected to the PC. This method of recovery with backup is described in the owner's manual.

1.1.4. Encryption

Transfer (copy) musical data (WMA/MP3/WAV format) stored in the PC to the HDD by using a PC application, TOSHIBA gigabeat room. This transfer is possible via USB. Data transferred is encrypted in the SAT format (Toshiba's unique format) to prevent reproduction of a reproduction.

Encryption is HDD dependent. For that reason, if you move encrypted musical data to the PC and write it back into the same HDD, then the data can be played back. However, it cannot be played back if the data was copied onto another HDD. If the HDD was replaced at the time of a repair, the encrypted musical data (a file with an extension .SAT) cannot be played back even if written into the new HDD.

1.1.5. How music is played back

This section explains how the unit plays back compressed musical data (WMA/MP3) or PCM musical data (WAV) stored on the HDD.

The CPU reads the compressed musical data (WMA/MP3) from the HDD and stores it on the SDRAM. The CPU accesses the HDD every few minutes and accumulates the data on the SDRAM. If the HDD is not used, the HDD is turned off to save power. PCM musical data (WAV) contains a large amount. When such data is handled, therefore, the HDD is always kept on.

The CPU restores compressed musical data on the SDRAM and converts it to PCM data.

The musical data restored to PCM data is sent from the SDRAM to the DAC by the CPU.

The DAC converts the sent PCM musical data to analog format and outputs it to the headphones. The CPU sets the volume control and equalizer levels on the DAC, which controls the volume control level and equalizer levels according to the settings made.

1.1.6. Transfer of musical data from the PC

When the unit is connected to the PC by USB, the Cypress AT2+ forms a bridge between the USB and HDD. The PC recognizes the unit as a USB mass storage device (a USB large-capacity storage device).

Copying musical data on the PC by using the TOSHIBA gigabeat room will encrypt the data on the PC. The encrypted data will then be sent to the gigabeat via USB.

The Cypress AT2+ writes the encrypted data onto the HDD according to the instructions issued by the PC.

2. Block diagram

2.1. Logic circuit block diagram

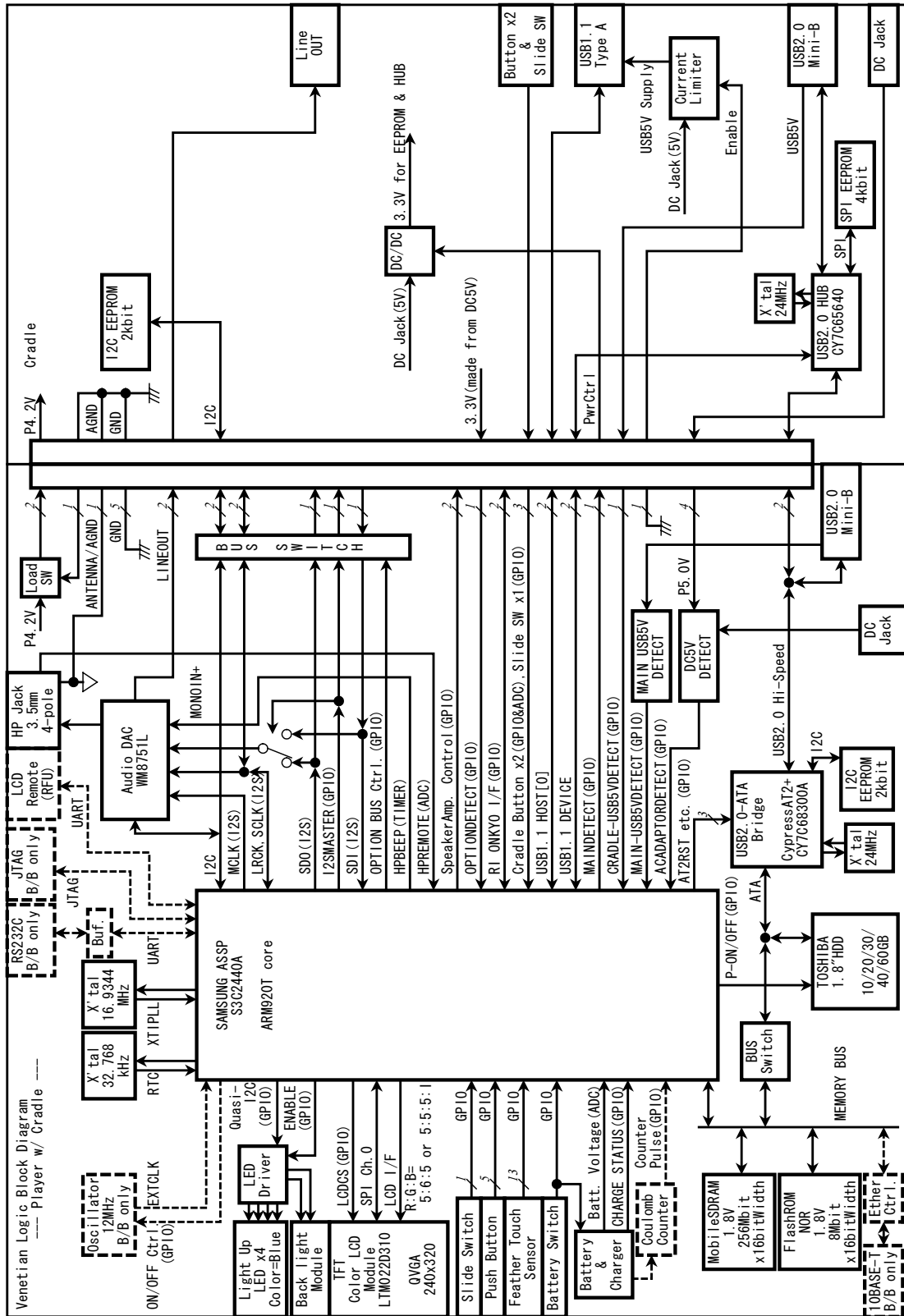

2.2. Power circuit block diagram

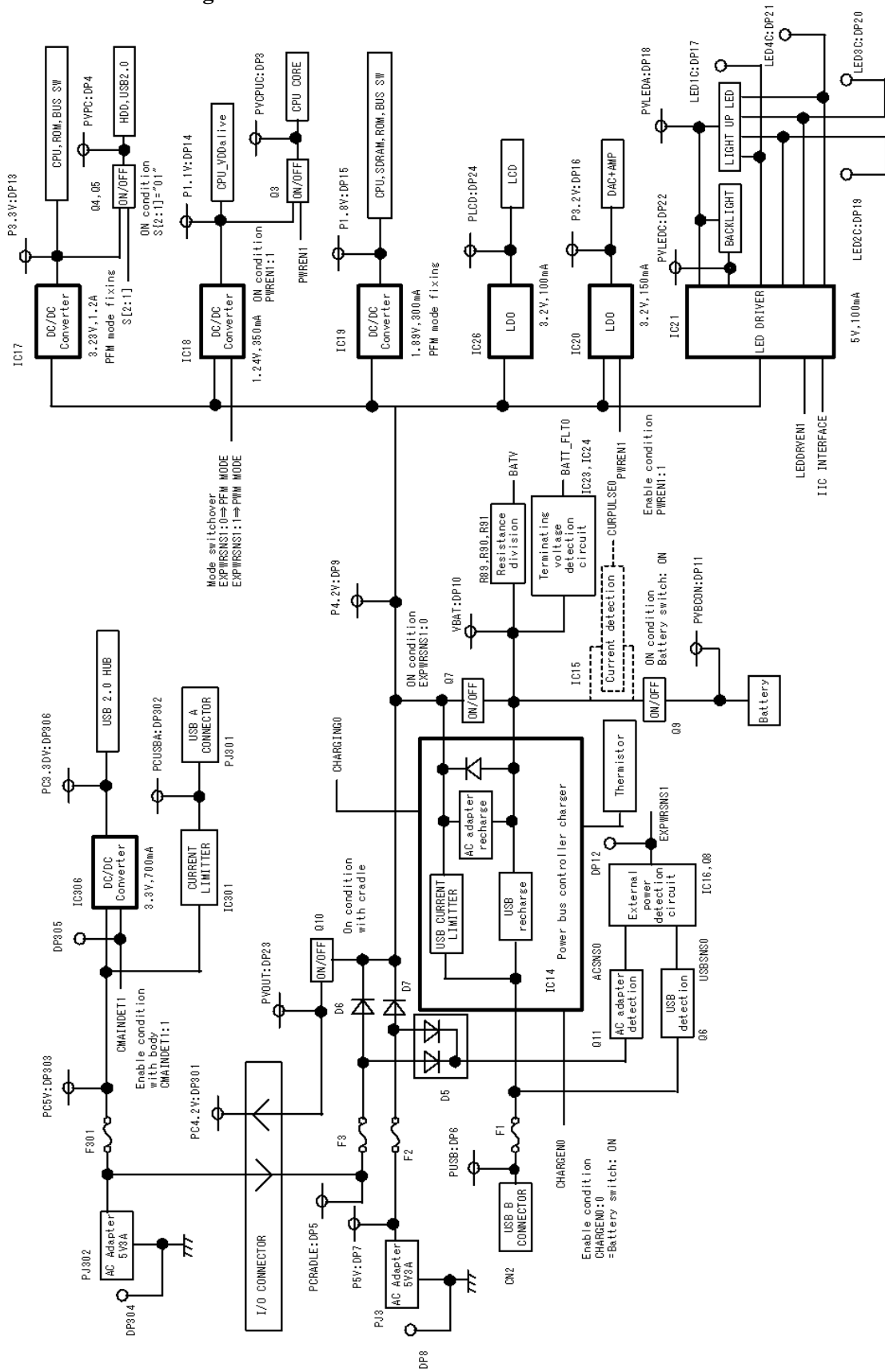

3. Cautions on repair

Before repairing a product of the gigabeat F series, take the following cautions:

3.1. Tell the owner that the contents of the HDD may be erased.

Replacing or formatting the HDD will clear the contents of the HDD. In receiving the product from the owner, ask him or her to make backup copies of important data.

3.2. Remove the AC adaptor and set the BATTERY switch to OFF.

Before disassembly, be sure to remove the AC adaptor and set the BATTERY switch to "OFF."

The gigabeat F series is such that its LCD and almost all ICs are powered even if the unit is turned off, if it is powered by the AC adaptor or battery. Before conducting a repair, therefore, the AC adaptor and battery must be removed.

Setting the BATTERY switch to "OFF" will stop the power supply from the battery, thus putting the unit into the same state as when the battery is removed.

3.3. When replacing the HDD

3.3.1. Protect the HDD from impact

Note that the HDD is vulnerable to impact. Merely falling the HDD from a vertical position would give an impact exceeding the specifications.

3.3.2. Holding the HDD

When holding the HDD, hold it at the following position:

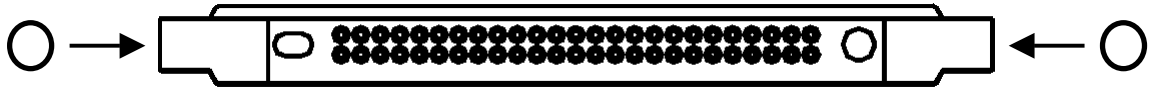

Do not hold it at the following position:

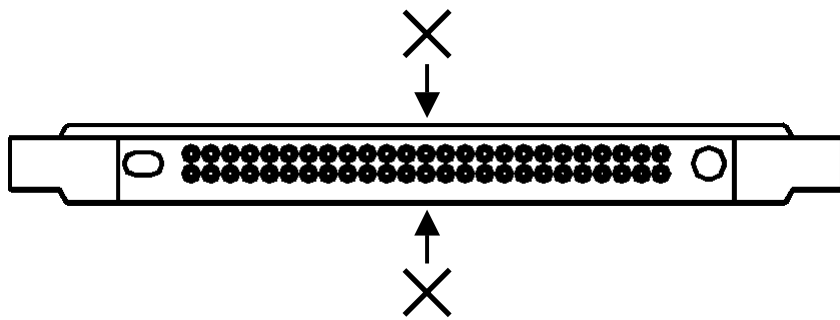

3.3.3. Formatting the HDD and transferring and updating the firmware

Replace the unformatted HDD, then format it.

After the formatting, transfer the firmware to the HDD and update the firmware.

Take the following steps to format the HDD:

- 1) Connect the HDD to the gigabeat F series.
- 2) Start "Computer Management" and select "Disk Management."

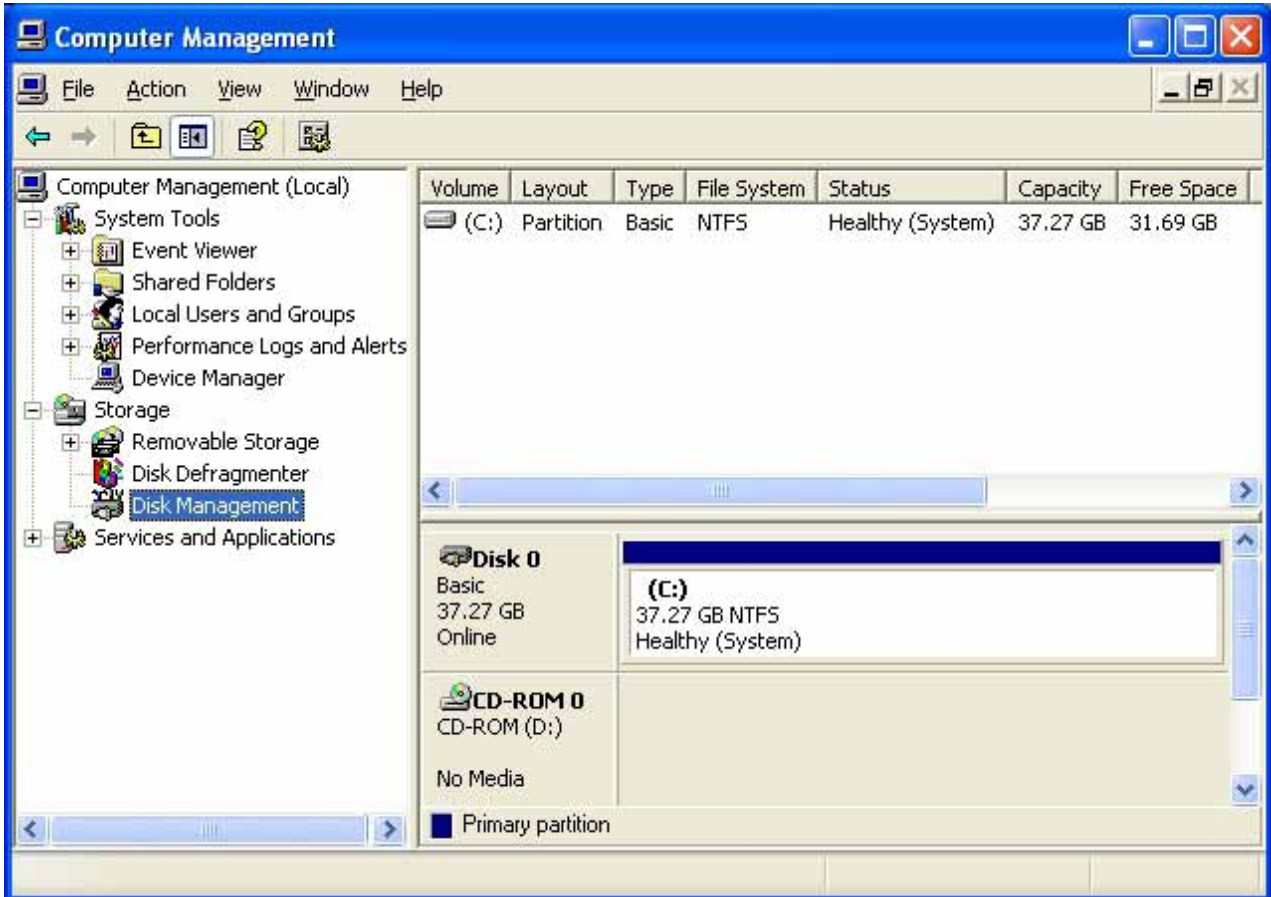

- 3) Make sure that the USB cable is connected to the PC, then connect the USB cable to the gigabeat F series.
- 4) Connect the AC adaptor to the gigabeat F series.
- 5) Hold down the POWER button to turn on the gigabeat F series.
- 6) Wait until the PC recognizes the gigabeat F series.

7) Right-click "Not Initialized" displayed on "Computer Management." Then click "Initialize Disk."

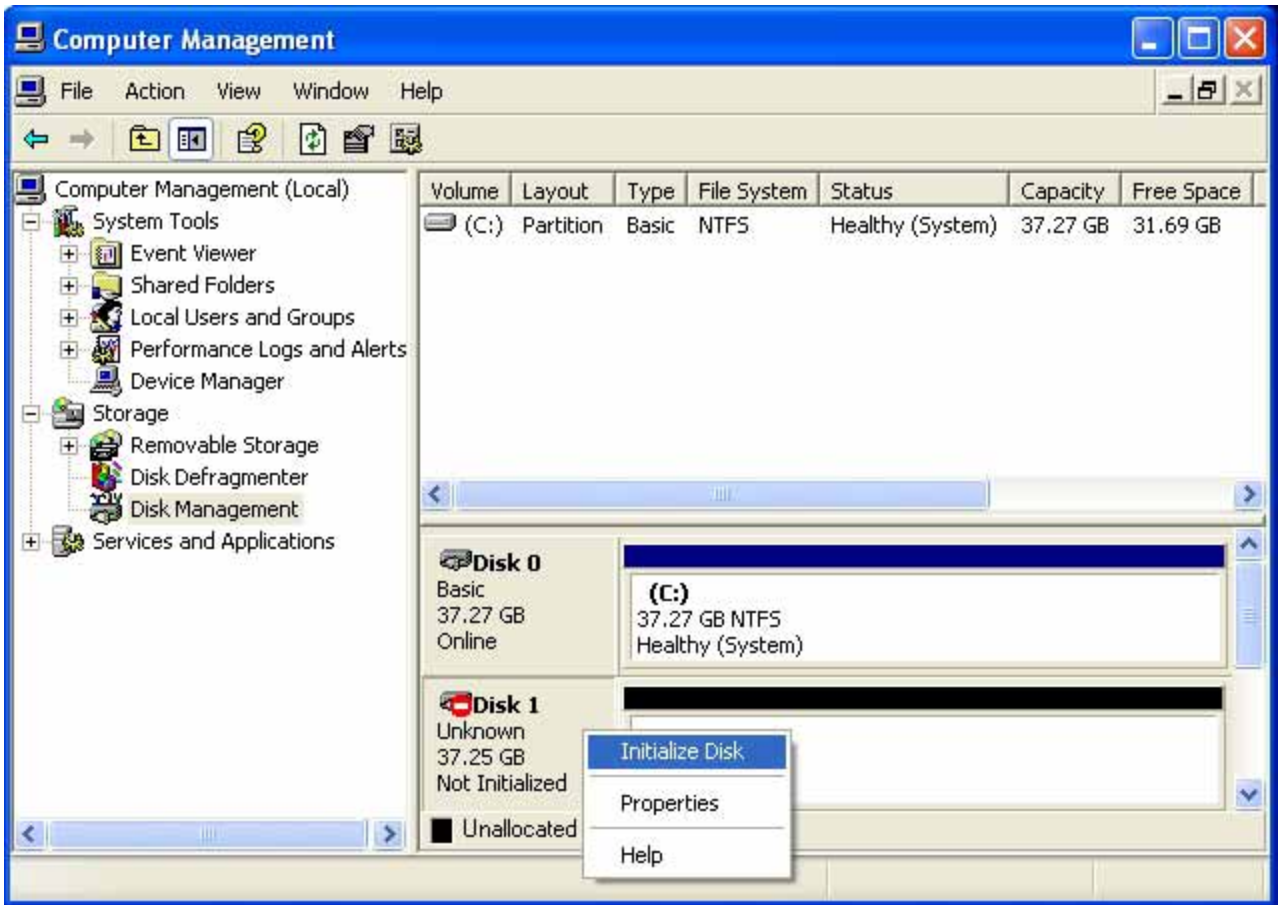

8) Confirm that Disk (in this case, Disk 1) of the gigabeat F series is checked. Then click OK.

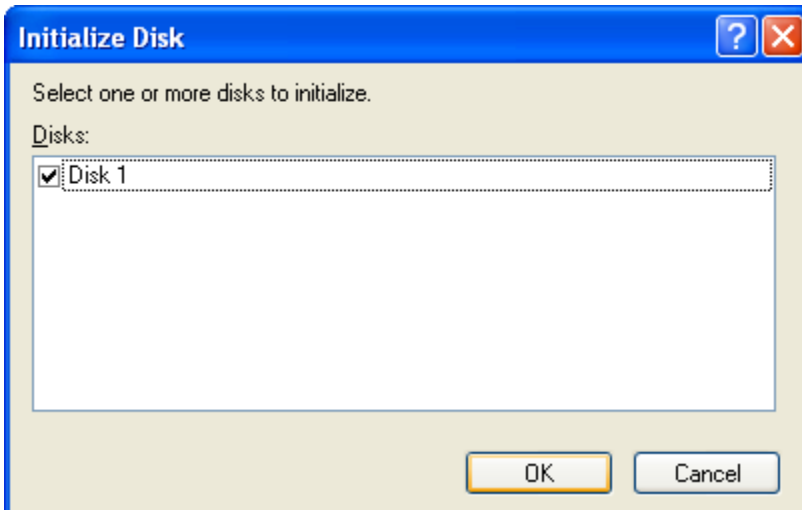

9) Right-click "Unallocated" displayed on "Computer Management." Then click "New Partition...."

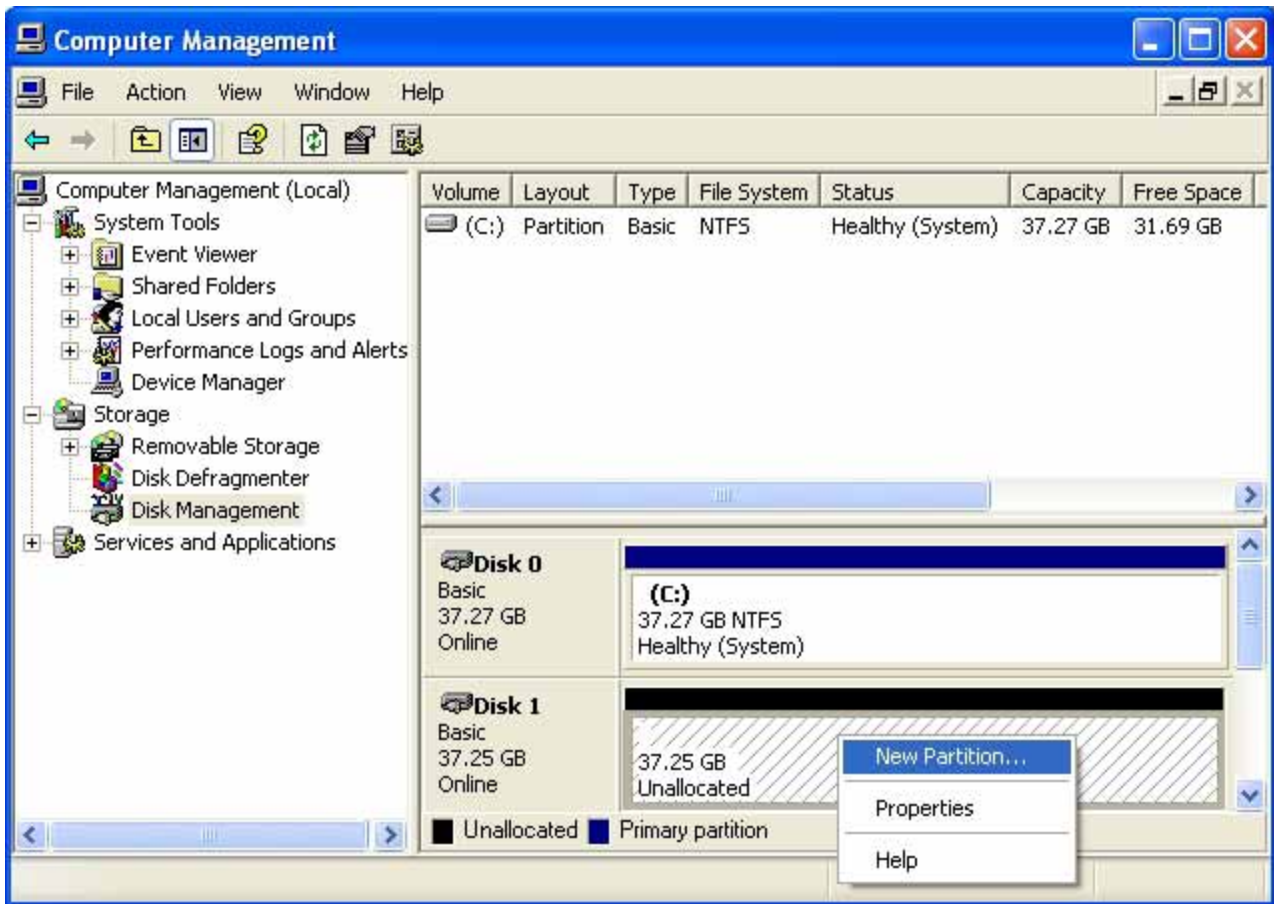

10) The screen displays "Welcome to the New Partition Wizard." Click "Next>."

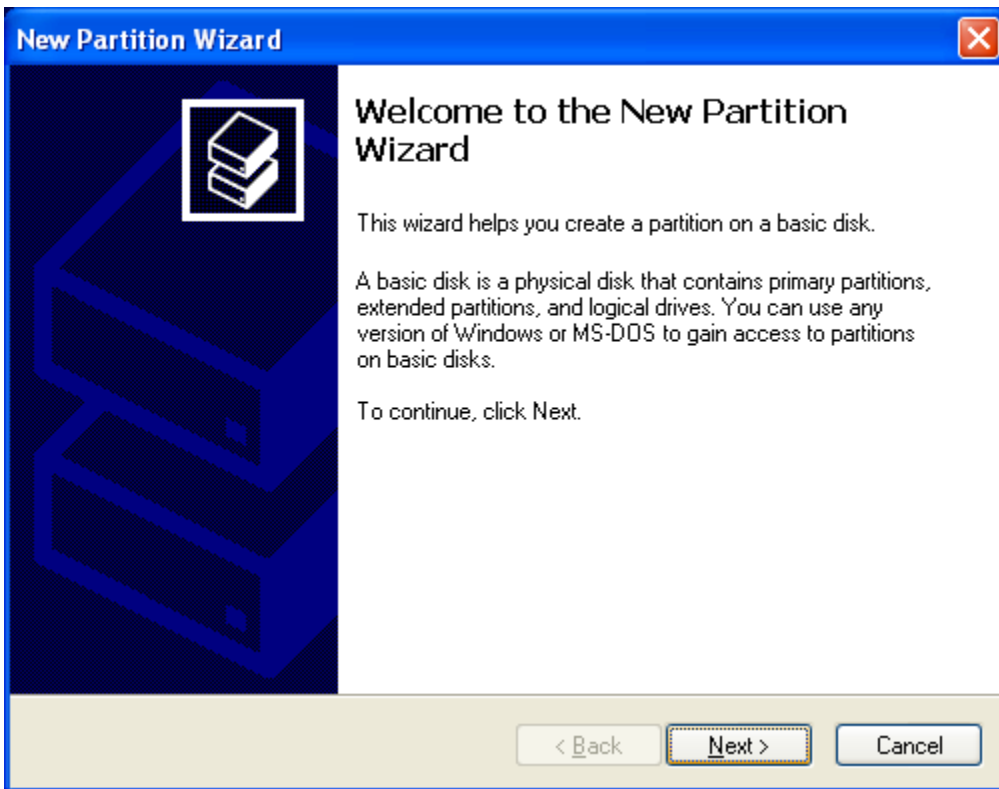

11) In "Select Partition Type," confirm that "Primary partition" is selected. Then click "Next>."

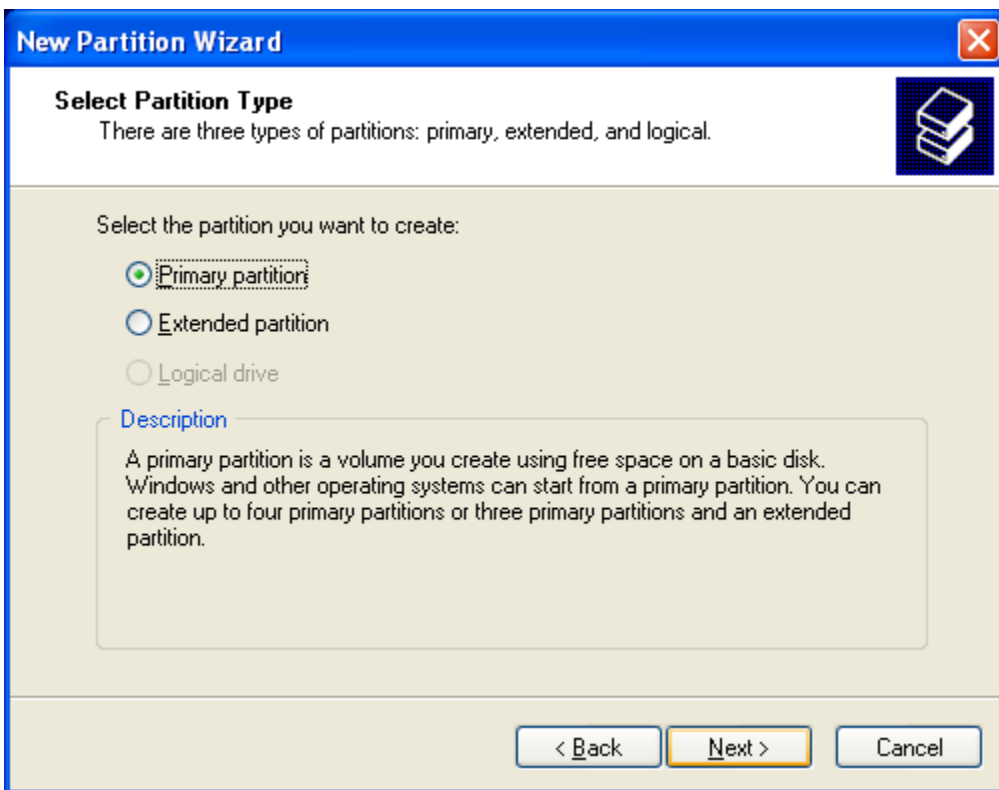

- 12) In "Specify Partition Size," confirm that the partition size is set to the maximum (in this case, 38139). Then click "Next>."
(Confirm that the default is set to the maximum. Click "Next>.")

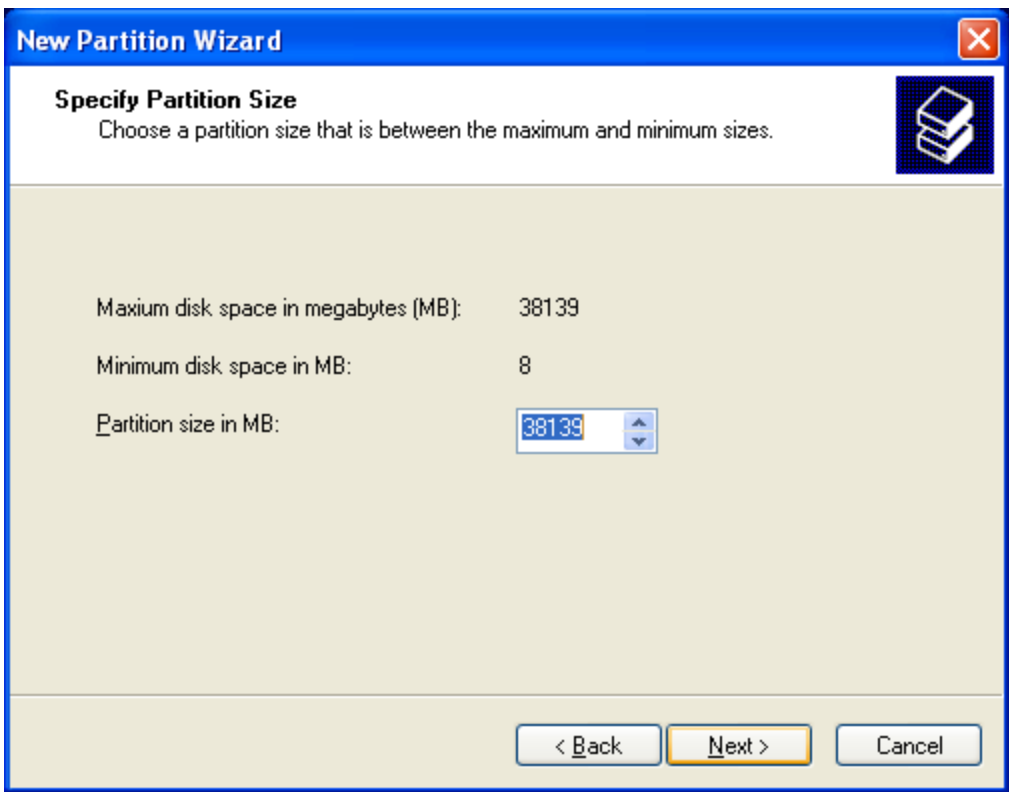

- 13) In "Assign Drive Letter or Path," confirm that "Assign the following drive letter:" is selected. Then click "Next>." The "drive letter:" may be set to any value (in this case, E:). (Confirm that the default is set to "Assign the following drive letter:". Then click "Next>.")

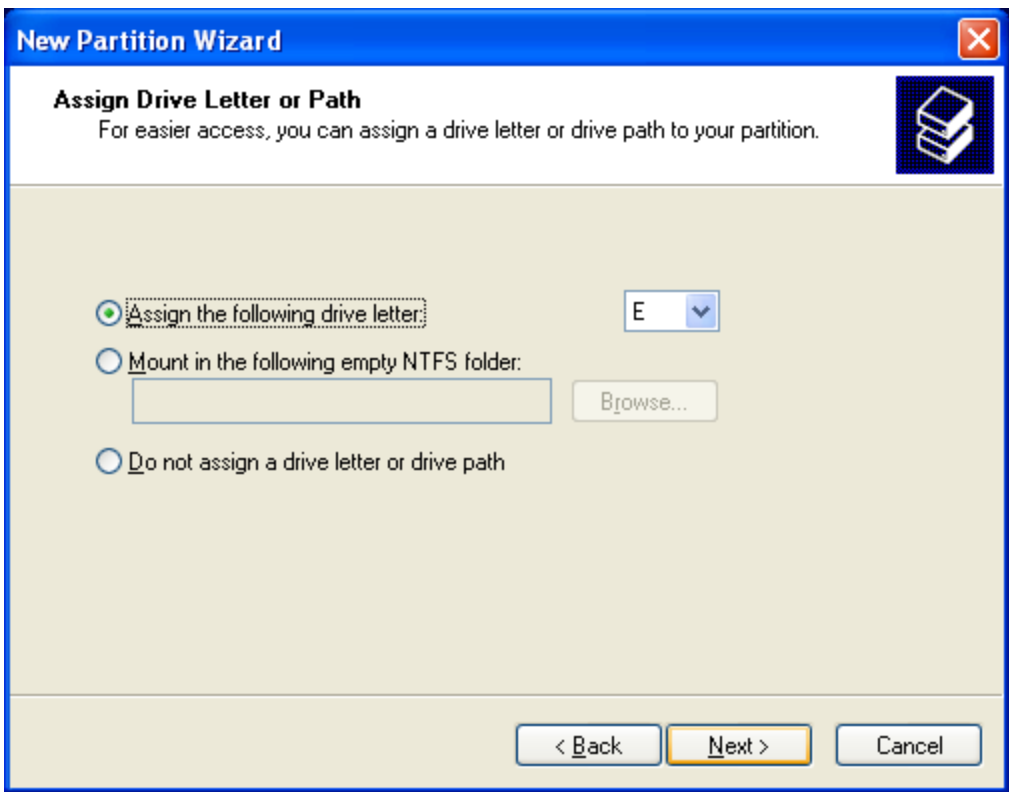

- 14) In "Format Partition," select "Do not format this partition." Then click "Next>."
(The default is set to "Format this partition with the following settings." Select "Do not format this partition." Then click "Next.>")

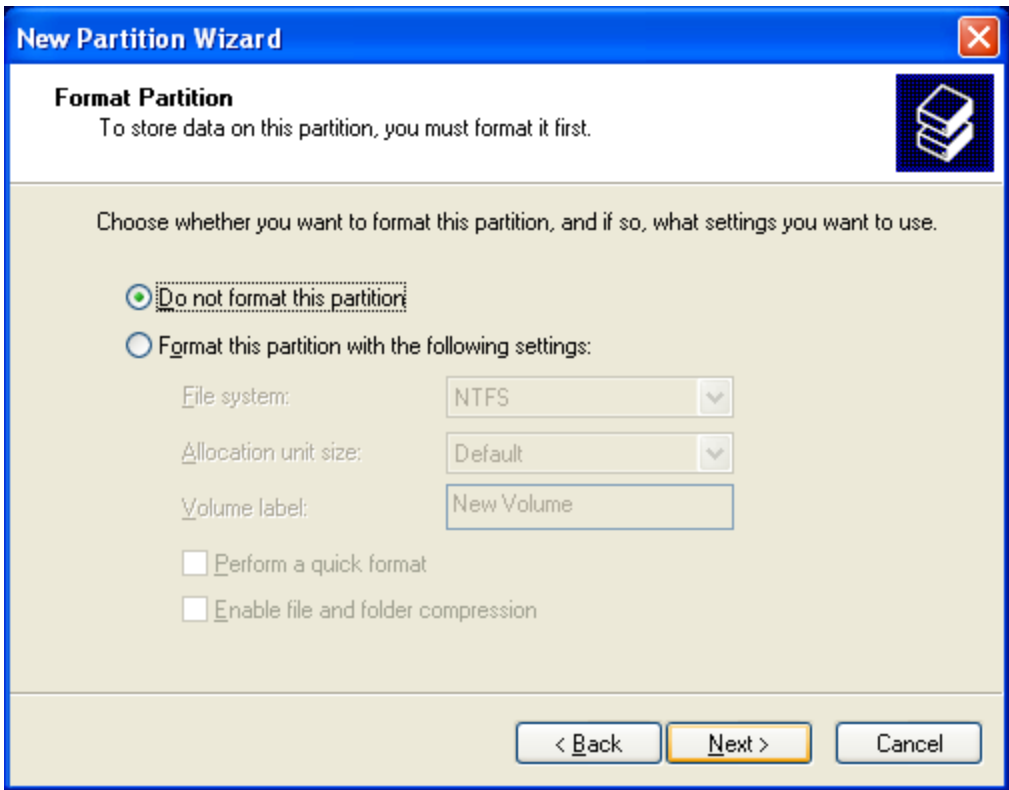

15) The screen displays "Completing the New Partition Wizard." Click "Finish." A new partition will be created in about five seconds.

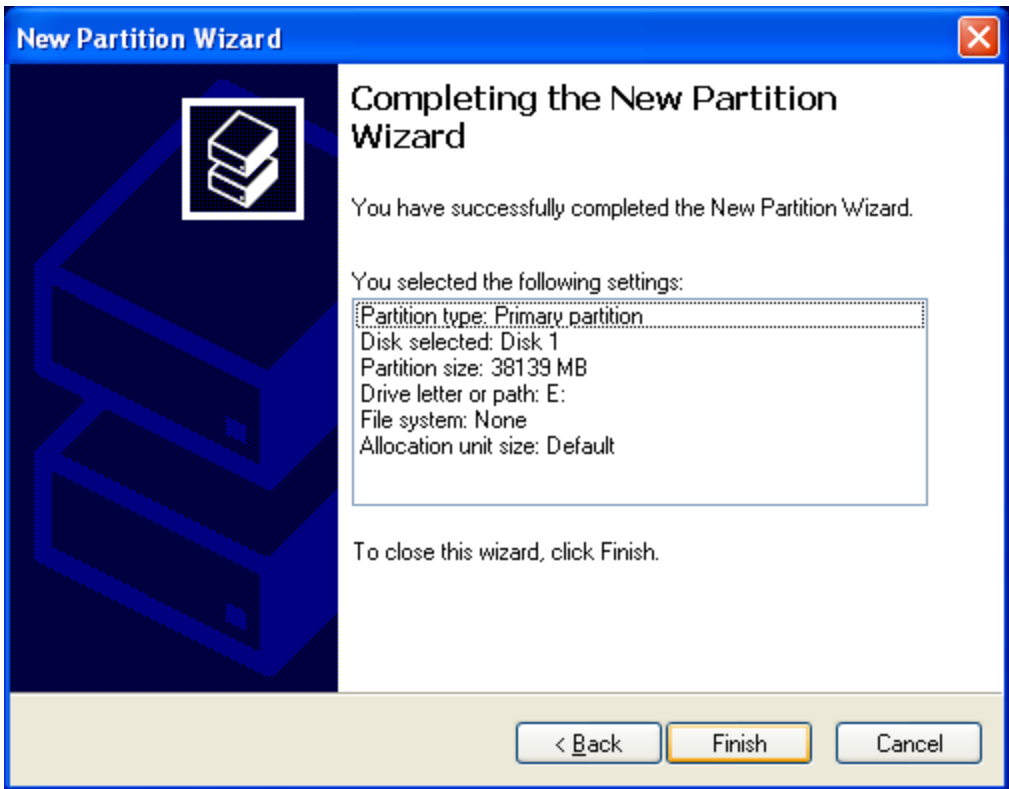

16) Execute GBFormat.exe.
GBFormat.exe is in C:\Program Files\TOSHIBA\gigabeat room.

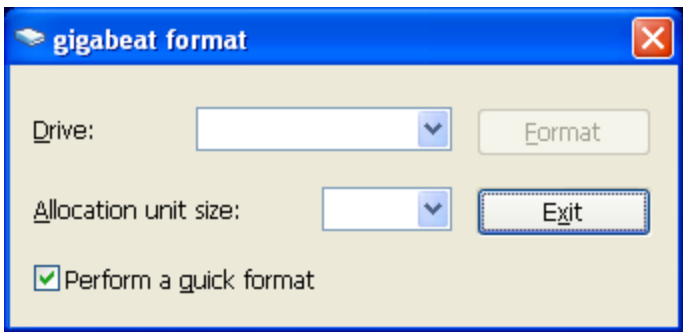

- 17) Set "Drive" to the drive letter assigned in "Assign Drive Letter or Path" (in this case, E:).
Set Allocation unit size to the default value (32KB).
Confirm that "Perform a quick format" is checked. Then click "Format."

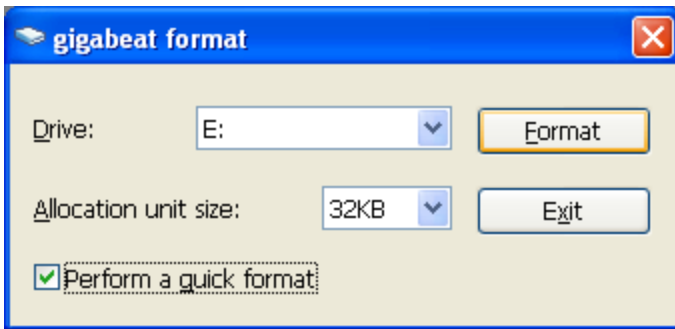

- 18) The screen displays a warning message. Click "OK."

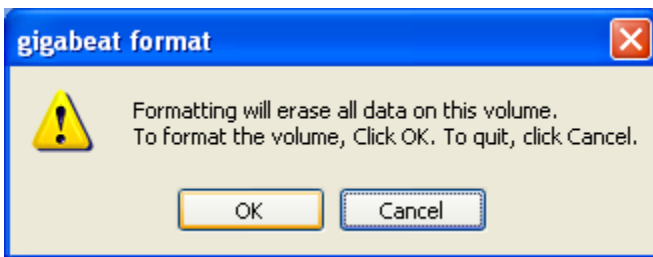

- 19) The formatting will be complete in about 15 seconds. During the formatting, the screen displays the progress bar as shown below.

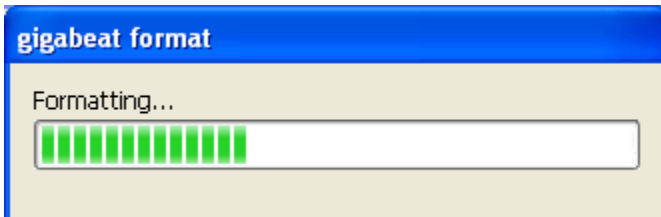

- 20) When the formatting is complete, the screen displays something as shown below. Click "OK."



21) In "Computer Management," click "Refresh" Or you may press the F5 key.

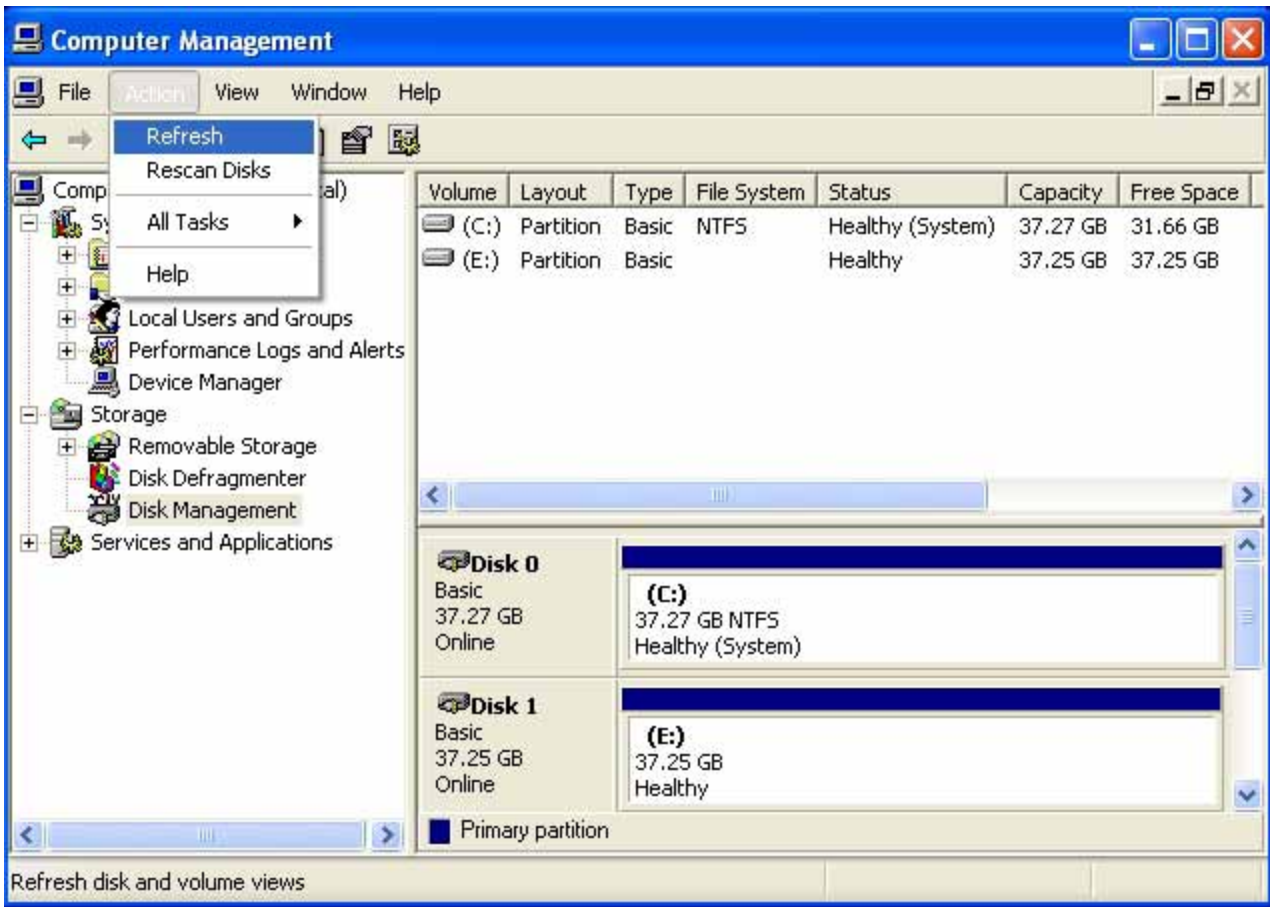

22) Confirm that the disk is formatted with FAT32. Confirm that the disk capacity is equal to the partition size (in this case, 37.25GB).

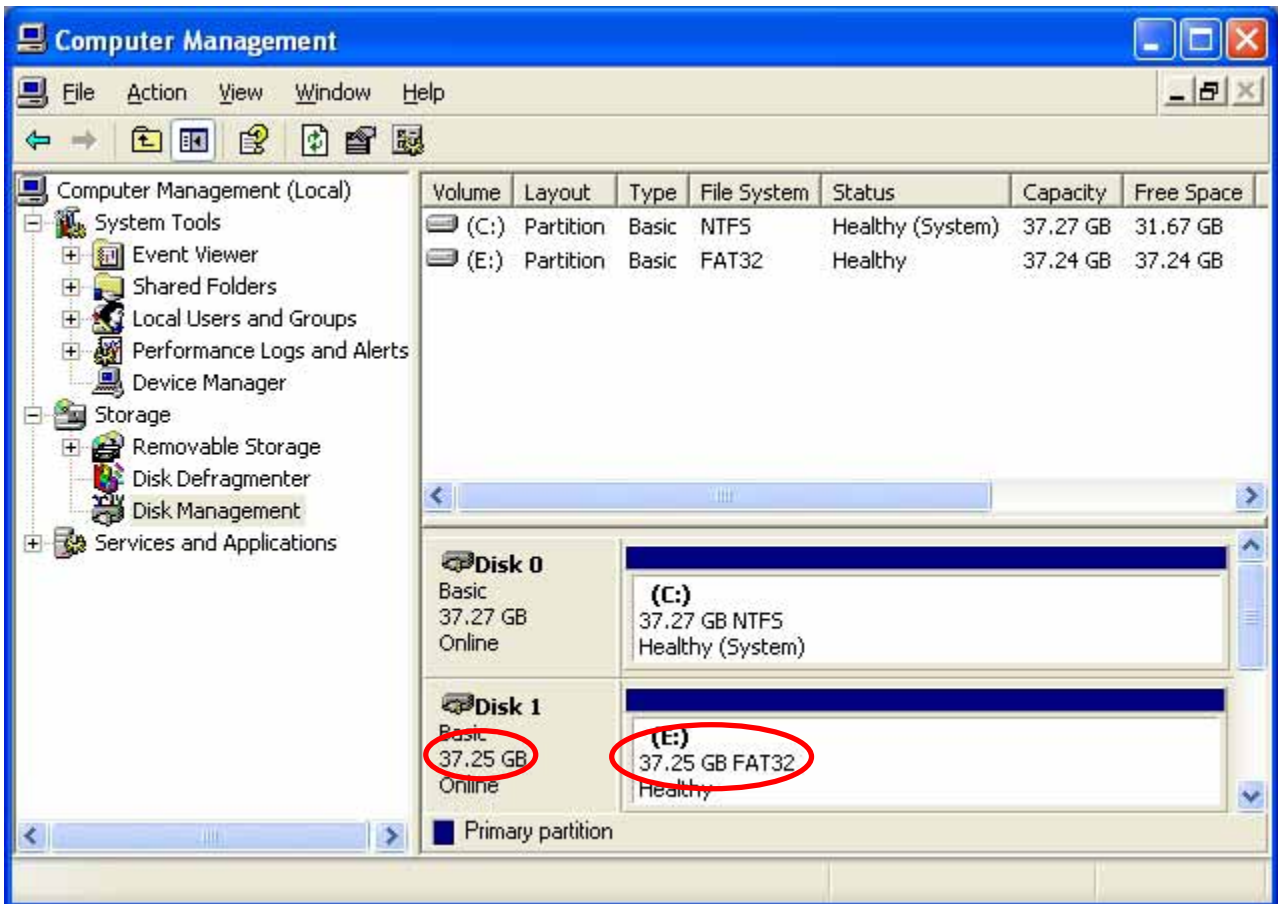

- 23) Insert the CD-ROM containing firmware into the CD-ROM drive of the PC.
Note that the CD-ROM used differs according to the model. For the CD-ROM, refer to “6. About the version of firmware”
- 24) Click "Start" - "All programs" - "Accessories" - "Command prompt" to open the command prompt.
- 25) At the command prompt, execute the commands shown below (where the CD-ROM drive is D: and the gigabeat F series is in E:.)
xcopy /H /E /K /Y /R D:\BootFWUP\E:
xcopy /H /E /K /Y /R D:\GBSYSTEM\E:
26) Close the command prompt.
- 27) Click "Safely Remove Hardware" in the Task tray.



- 28) Click "Safely remove USB Mass Storage Device - Drive (E:)." (In this case, it is E:.)



- 29) Confirm that "Safe To Remove Hardware" is displayed then remove the USB cable from the gigabeat F series.



- 30) Remove the AC adaptor.
- 31) Turn off the BATTERY switch.
- 32) While holding down the POWER and MENU buttons, connect the AC adaptor to the gigabeat F series. This startup method updates the firmware. During the update, do not pull out the AC adaptor.
- 33) When the firmware update is complete, pull out the AC adaptor.
- 34) Turn on the BATTERY switch.
- 35) Connect the AC adaptor to the gigabeat F series.
- 36) Hold down the POWER button.
- 37) When the date and time configuration screen is displayed, press the middle of the Plus Touch to exit the date configuration screen.
- 38) In the top menu, select "Set" - "System" to confirm the firmware version.
- 39) If a newer version of firmware is downloadable from the Website, download it and make an update according to the procedure specified on the Website.
If updating Ver 1.xx to Ver 2.xxx, version upgrade of the PC software gigabeat room is required. Confirm that the owner has gigabeat room 2.x for Ver 2.xxx, and then update Ver 1.xx to Ver 2.xxx.
- 40) Connect the gigabeat F series to the PC.
- 41) Start the Explorer. If the HDD of the gigabeat F series contains the \update folder, delete it.

- 42) Open the command prompt, execute the commands specified below, and add the SYSTEM and HIDDEN attributes to the %GBSYSTEM%.
- ```
attrib +S +H -R E:%GBSYSTEM%* /S /D
attrib +S +H -R E:%GBSYSTEM%
```
- 43) Close the command prompt.
- 44) Execute 27) to 29) above and remove the USB cable from the gigabeat F series.



### 3.4. When replacing the main board

#### 3.4.1. Updating the firmware

After replacing the main board, take the following steps to update the firmware.

Firmware is stored in two places, FlashROM and HDD on the main board, as explained in “1.1.3. Place for storing firmware.” Different version of the firmware in the two places may cause malfunction. When replacing the board, take the following steps to update the firmware and match the version in the two places.

For the procedure when replacing the HDD, refer to “3.3. When replacing the HDD.”

- 1) Connect the USB cable to the PC and then connect the USB cable to the gigabeat F series.
- 2) Connect the AC adapter to the gigabeat F series.
- 3) Hold down the POWER button to turn on the gigabeat F series. When the date configuration screen is displayed, press the middle of the Plus Touch to exit the date configuration screen.
- 4) Wait until the PC recognizes the gigabeat F series.
- 5) Insert the CD-ROM containing firmware into the CD-ROM drive of the PC.  
Note that the CD-ROM used differs according to the model. For the CD-ROM, refer to “6. About the version of firmware”
- 6) Click “Start” – “All programs” – “Accessories” – “Command prompt” to open the command prompt.
- 7) At the command prompt, execute the commands shown below (where the CD-ROM drive is D: and the gigabeat F series is in E:.)  
`del /Q E:\GBSYSTEM\FWIMG*`  
`del /Q /ASH E:\GBSYSTEM\FWIMG*`  
`xcopy /H /E /K /Y /R D:\Boot\FWUP* E:\`  
`xcopy /H /E /K /Y /R D:\GBSYSTEM* E:\`
- 8) Close the command prompt.
- 9) Click “Safely Remove Hardware” in the Task tray.

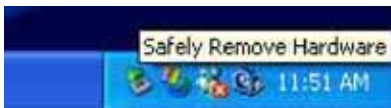

- 10) Click “Safely remove USB Mass Storage Device – Drive(E:).” (In this case, it is E:.)



- 11) Confirm that “Safe To Remove Hardware” is displayed and then remove the USB cable from the gigabeat F series.



- 12) Remove the AC adapter.
- 13) Turn off the BATTERY switch.
- 14) While holding down the POWER and MENU buttons, connect the AC adapter to the gigabeat F series. This startup method updates the firmware. During the update, do not pull out the AC adapter.
- 15) When the firmware update is complete, pull out the AC adapter.
- 16) Turn on the BATTERY switch.

- 17) Connect the AC adapter to the gigabeat F series.
- 18) Hold down the POWER button.
- 19) When the date and time configuration screen is displayed, press the middle of the Plus Touch to exit the date configuration screen.
- 20) In the main menu, select “SETUP” – “SYSTEM” to confirm the firmware version.
- 21) If a newer version of firmware is downloadable from the Website, download it and make an update according to the procedure specified on the Website.  
 If updating Ver 1.xx to Ver 2.xxx, version upgrade is required for the PC software gigabeat room. Confirm that the owner has gigabeat room 2.x for Ver 2.xxx, and then update Ver 1.xx to Ver 2.xxx.  
 Connect the gigabeat F series to the PC.
- 23) Start the Explorer. If the HDD of the gigabeat F series contains the ¥update folder, delete it.
- 24) Open the command prompt, execute the commands specified below, and add the SYSTEM and HIDDEN attributes to the ¥GBSYSTEM.  
`attrib +S +H -R E:¥GBSYSTEM¥* /S /D`  
`attrib +S +H -R E:¥GBSYSTEM`
- 25) Close the command prompt.
- 26) Execute 9) to 11) above and remove the USB cable from the gigabeat F series.

### 3.5. Replacing the base

#### 3.5.1. Replacing the serial label

The base has a serial label indicating the manufacturer's serial number of the unit. In replacing the base, remove the serial label and attach it to the new base.

#### 3.5.2. Installing the strap holder

Fix the strap holder to the base with hot melt as shown in the figure below.

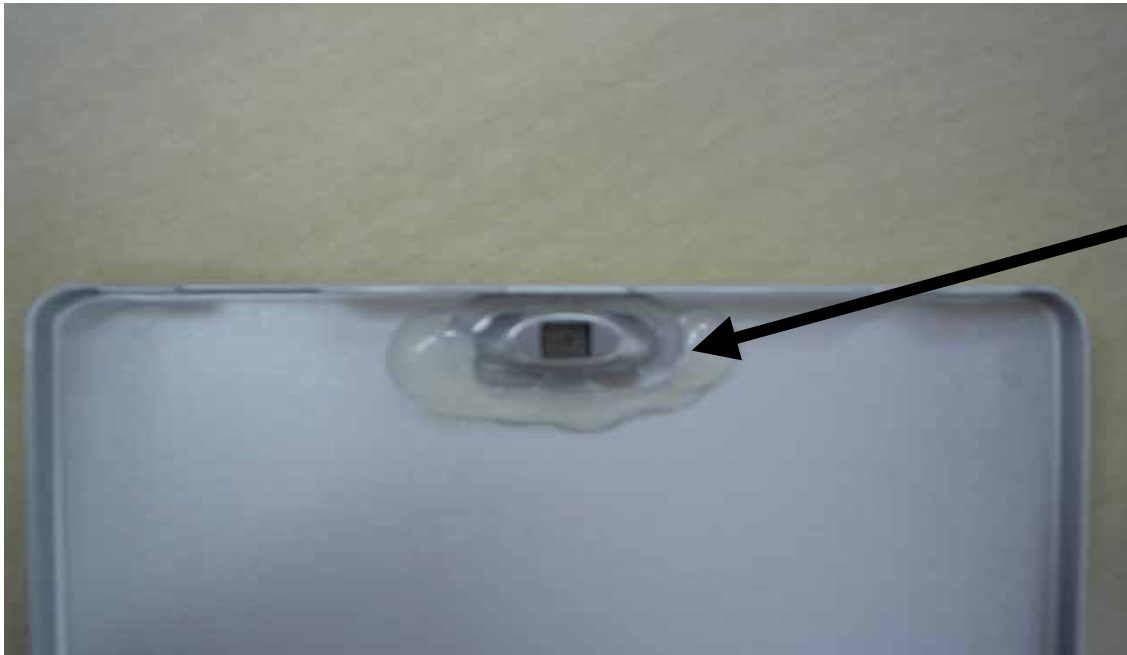

Circumference,  
bottom 1/2  
Circumference  
+5mm maximum

### 3.6. Replacing the frame

#### 3.6.1. Attaching the SW flexible cable and sheet switch

Attach the SW flexible cable to the frame. On top of it, attach the sheet switch.

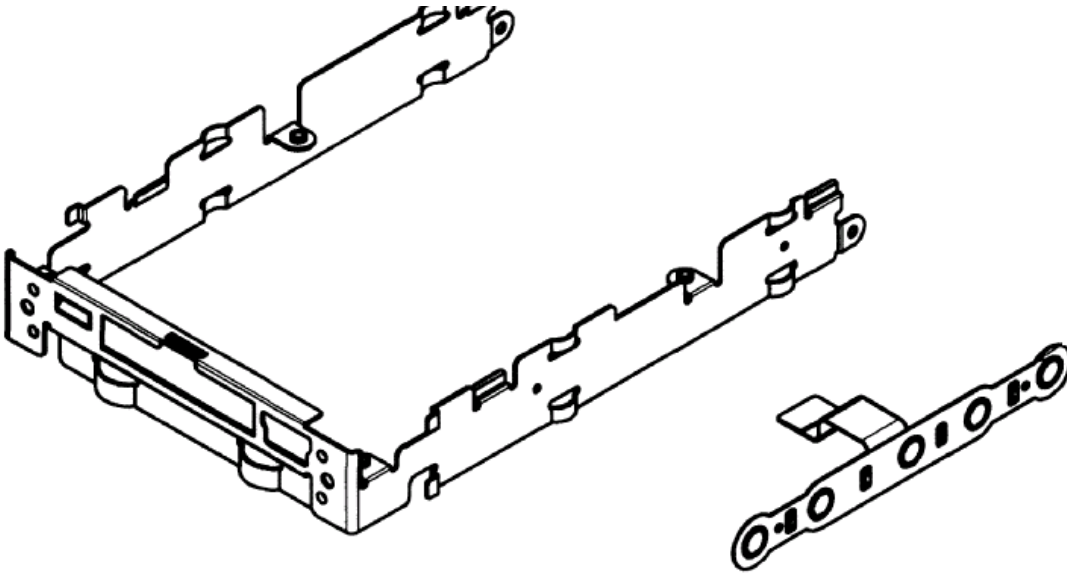

### 3.7. Replacing the LCD and LCD backlight unit

#### 3.7.1. Incorporating them into the LCD frame

Peel off the protective film from the LCD and LCD backlight, then incorporate them into the LCD frame. Guard against fingerprints and dust.

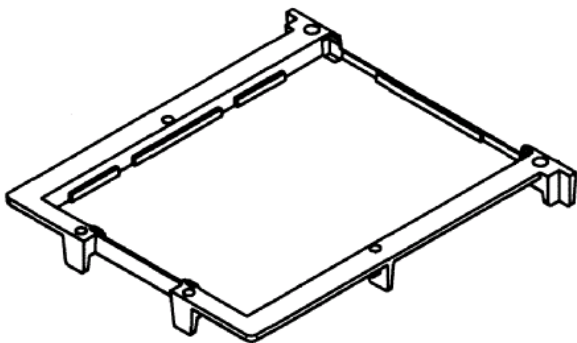
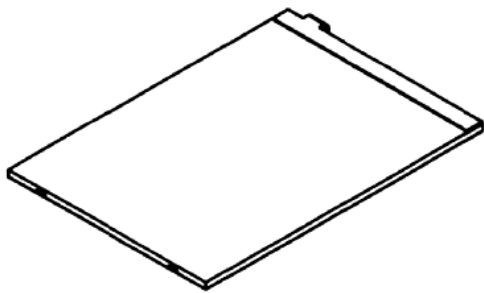
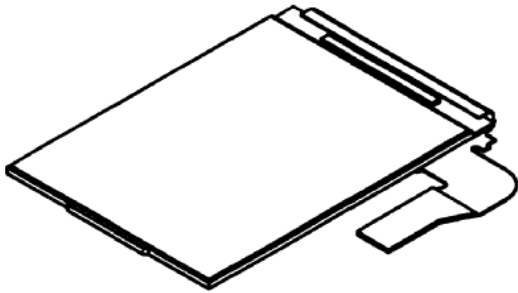

### 3.8. Replacing the lithium-ion battery

#### 3.8.1. Attaching the two RUB BATs

Attach the two RUB BATs to the bottom (the side in contact with the Venetian main PCB assembly) of the lithium-ion battery as illustrated below.

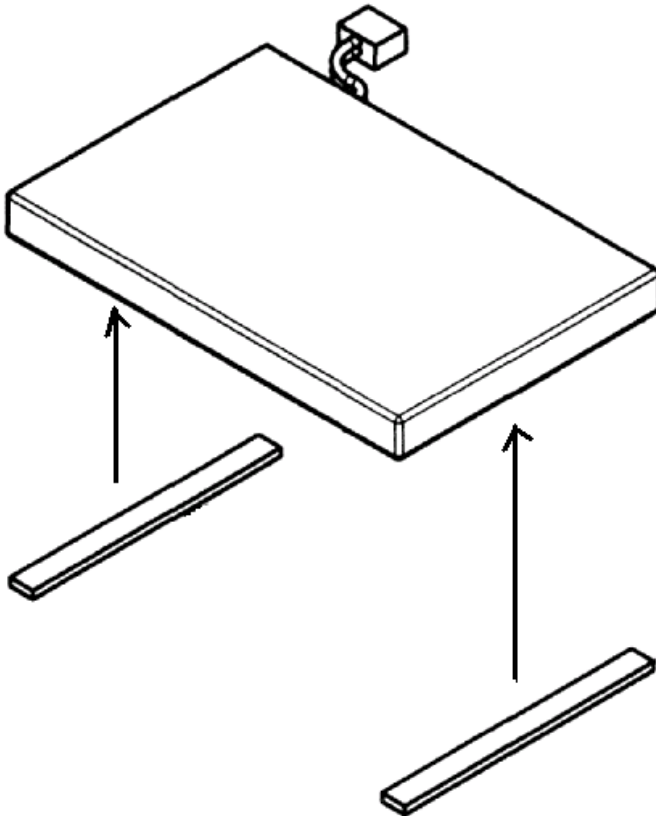

### 3.9. Replacing the cradle

Note that the cradle comes in two types according to the thickness of the unit (the capacity of the built-in HDD). Note also that for some models the cradle is optional, not furnished with the unit.

For thinner models (30GB or less): VENETIAN-CRADLE-MEGBCS13

For thicker models (more than 30GB): VENETIAN-CRADLE-MEGBCS14

## **4. Troubleshooting**

Shown below is the defect analysis procedure as a maintenance service.

Before a repair (parts replacement), be sure to see "3. Cautions on repair. "

### **4.1. Anticipated defects**

- 1) The unit will not turn on.
- 2) No sound comes out.
- 3) The sound is odd.
- 4) The LCD display is odd.
- 5) Operating the buttons on the unit does not work.
- 6) Remote control does not work.
- 7) A USB connection cannot be established.
- 8) The battery cannot be recharged. (When battery-powered, the unit plays back only for a short time.)
- 9) HDD is not recognized.
- 10) The unit cannot be recharged with the cradle.

## 4.2. Defect analysis procedure as a maintenance service

### 4.2.1. The unit will not turn on.

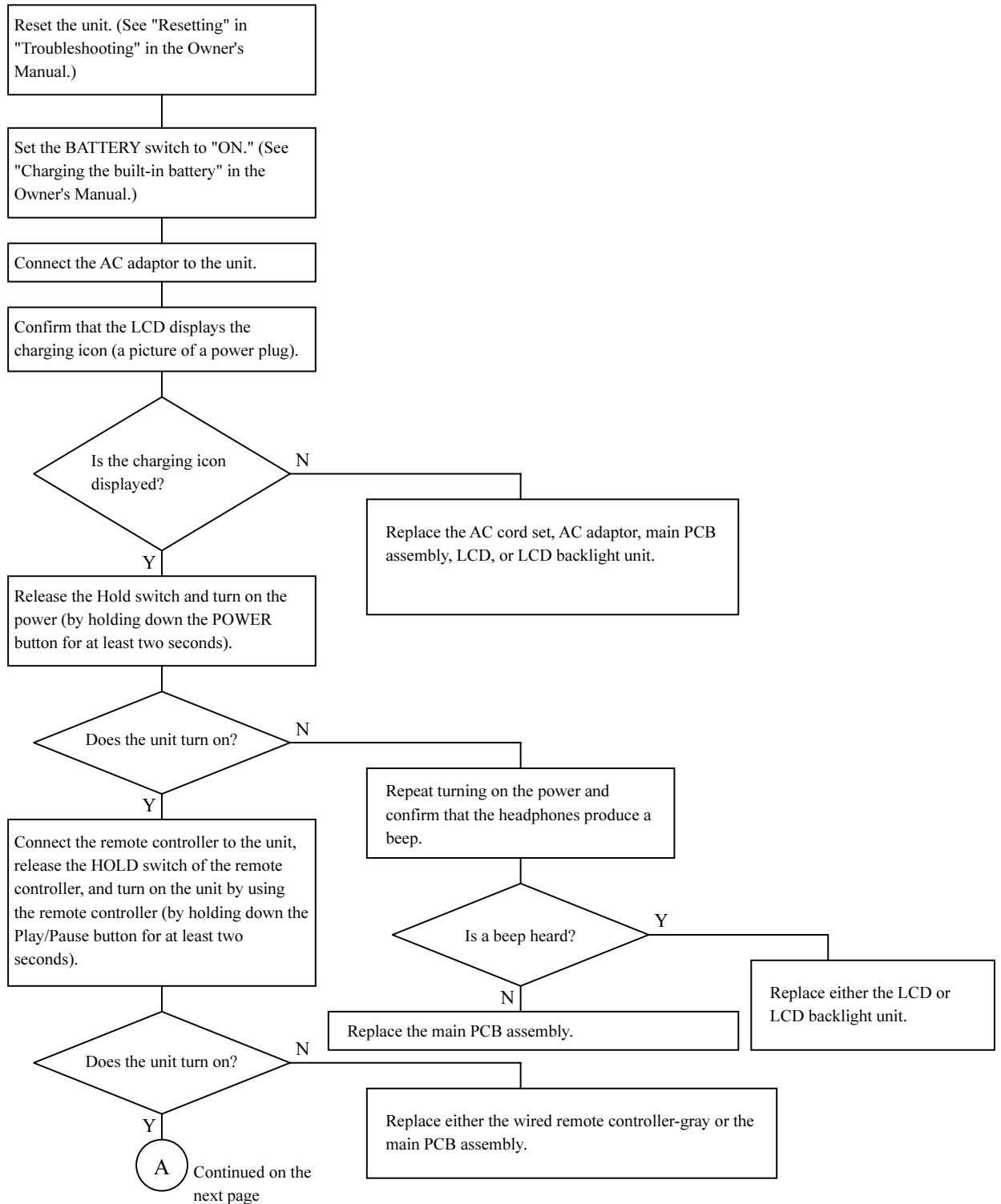



A Continued from the previous page

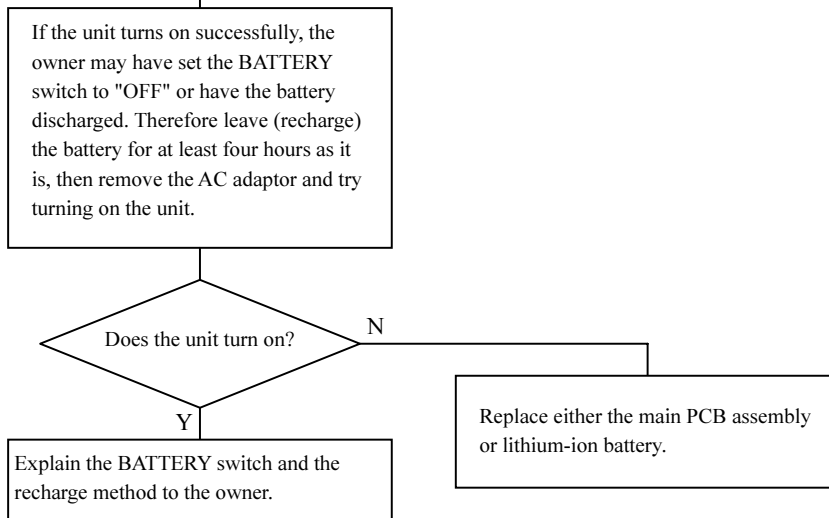

#### 4.2.2. No sound comes out.

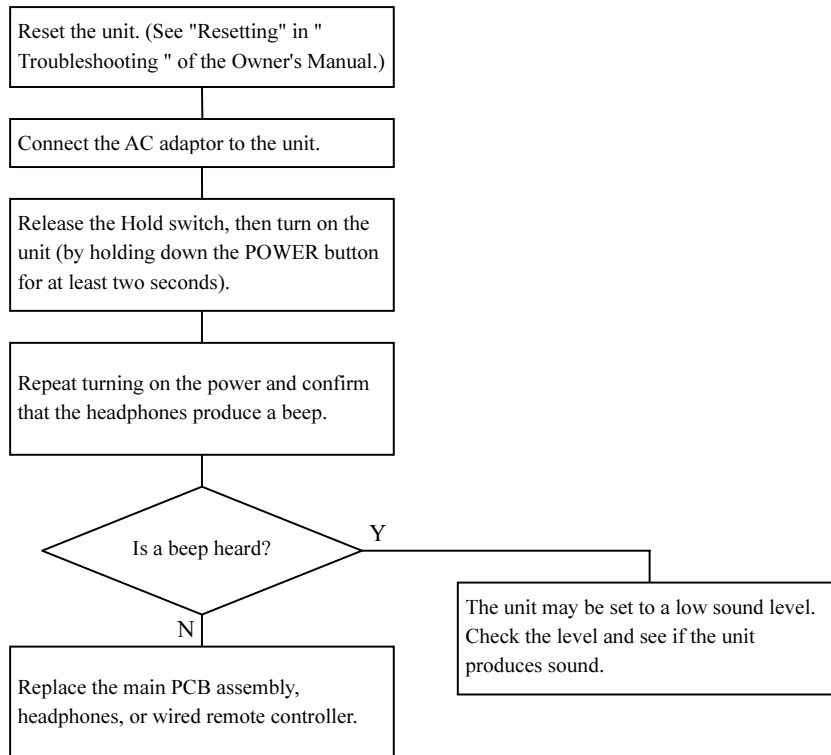

**4.2.3. The sound is odd.**

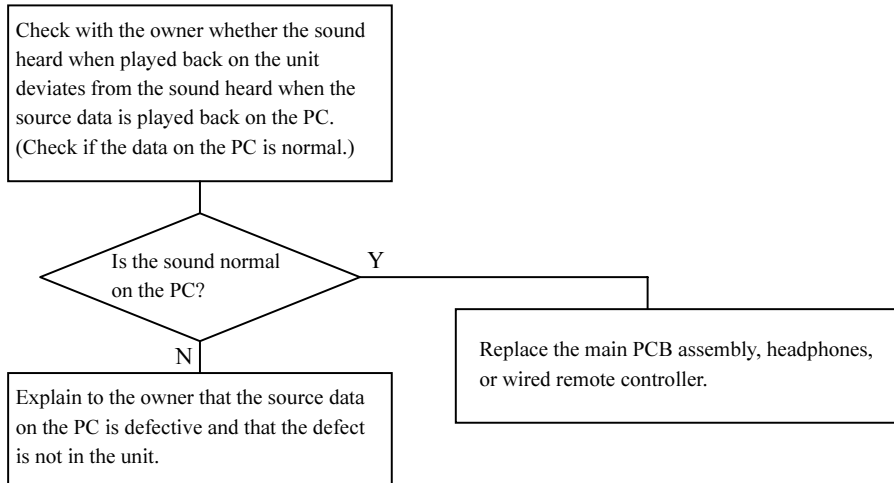

**4.2.4. The LCD display is odd.**

Replace the main PCB assembly, LCD, or LCD backlight unit.

**4.2.5. Operating the buttons on the unit does not work.**

If the problem is with the buttons on the side of the unit;  
Replace the SW flexible cable, sheet switch, or main PCB assembly.  
If the problem is with the Puls Touch;  
Replace either the feather touch sensor or main PCB assembly.  
If the problem is with the HOLD or BATTERY switch;  
Replace the main PCB assembly.

**4.2.6. Remote control does not work.**

Replace either the wired remote controller-gray or the main PCB assembly.

**4.2.7. A USB connection cannot be established**

Replace the cradle, main PCB assembly, or USB cable.

**4.2.8. The battery cannot be recharged. (When battery-powered, the unit plays back only for a short time.)**

Conduct a hearing of how the owner has been using the unit. If he or she is suspected of having repeated at least 500 recharge-discharge operations, the battery may have come to the end of its service life. Therefore replace the lithium-ion battery.

The playback time (16 hours) of the battery as specified in the catalogs is applicable when the WMA format sound is played back. Sound in the MP3 format can also be played back for almost the same amount of time. However, sound in the WAV format can be played back for about four hours only. Explain this as well to the owner.

In all other cases, take the steps described below to conduct a repair.

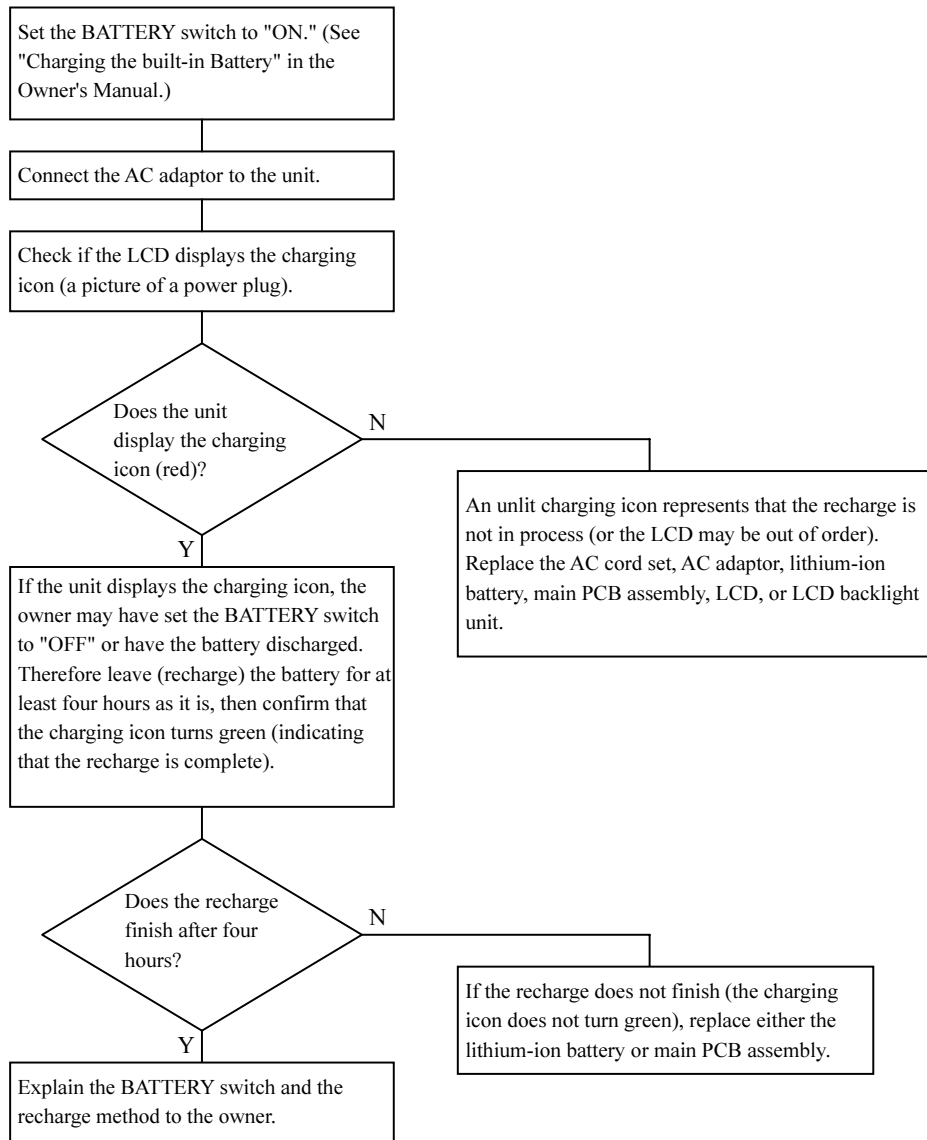

#### 4.2.9. HDD is not recognized

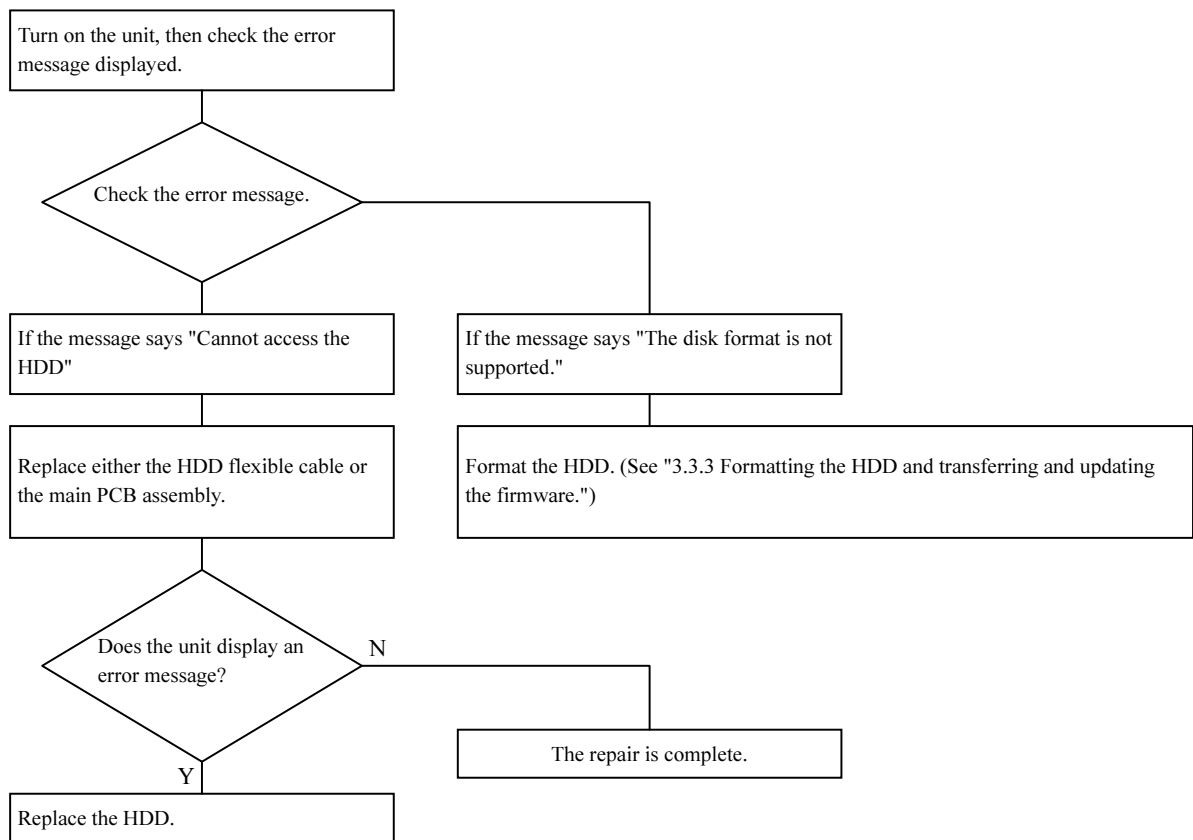

#### 4.2.10. The unit cannot be recharged with the cradle.

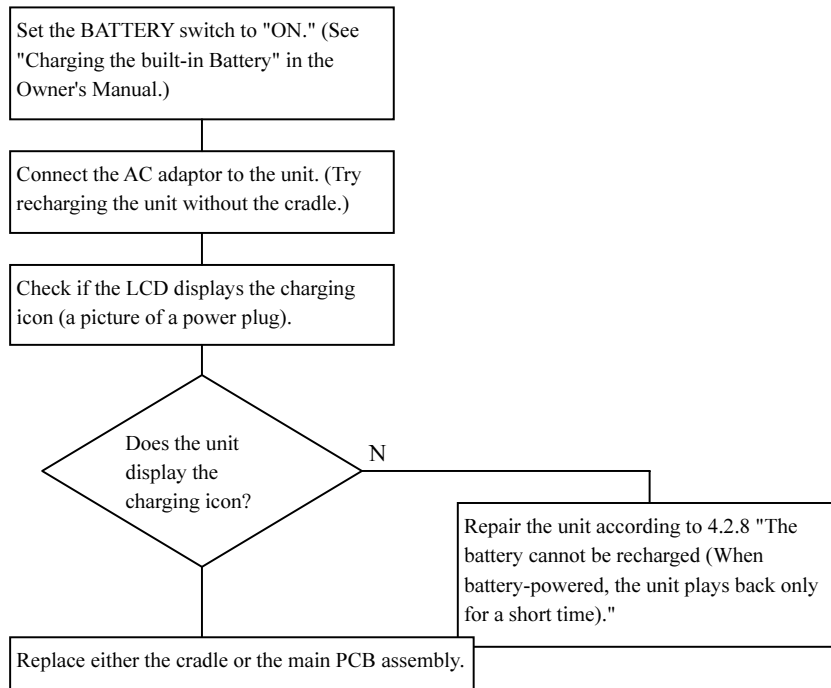

## 5. Procedure to confirm the firmware version

Take the following steps to display the firmware version.

- 1) Hold down the POWER button. (The unit will turn on.)
- 2) If the main menu is not displayed, press the POWER button. (The top menu will be displayed.)
- 3) In the MAIN MENU, touch the top or bottom of the Plus Touch and select "SETUP", then touch the right of the Plus Touch. (The Setup window appears.)
- 4) Touch the top or bottom of the Plus Touch and select "SYSTEM" then touch the right of the Plus Touch (The firmware version will be displayed.)
- 5) For the version 2.01x or later, one digit of the version number is hidden. In this case, press the Plus Touch in the order of  $\uparrow \rightarrow \downarrow \uparrow \rightarrow \downarrow$ . (All digits of the version number will be displayed.)
- 6) Hold down the POWER button. (The unit will turn off.)

## 6. About the version of firmware

The firmware version of the unit corresponds to the version of the PC application software (gigabeat room) as shown in the table below. If the other combination is used, malfunction may occur, such as the problem that transferred music cannot be heard. When updating the firmware, proper firmware version should be used in consideration of the combination.

If the firmware version of the unit cannot be confirmed because of the board or HDD failure, refer to the Model Name in the table below and judge which version of BootFlashROM Writing Tool CD should be used.

| Destination | FW Version  | Model Name                | PC application |             |                       | Version of "BootFlashROM Writing Tool CD" and part number |
|-------------|-------------|---------------------------|----------------|-------------|-----------------------|-----------------------------------------------------------|
|             |             |                           | CD-ROM Version | Label Color | gigabeat room Version |                                                           |
| JP          | 1.01JP      | F10/F20/F60               | 1.01           | Blue        | 1.01                  | R10 (1.07JP)<br>360053206                                 |
|             | 1.02JP      |                           |                |             |                       |                                                           |
|             | 1.03JP      |                           |                |             |                       |                                                           |
|             | 1.04JP      |                           |                |             |                       |                                                           |
|             | 1.05JP      |                           |                |             |                       |                                                           |
|             | 1.06JP      |                           |                |             |                       |                                                           |
|             | 1.07JP      |                           |                |             |                       |                                                           |
|             | 2.000JP     | F40                       | 2.0JP          | Magenta     | 2.000JP               | R21 (2.0106JP)<br>360054610                               |
|             | 2.0100JP    | F11/F21/F41               |                |             |                       |                                                           |
|             | 2.0106JP    |                           |                |             |                       |                                                           |
| 2.0205JP    | Web release | No CD-ROM supplied        |                |             |                       |                                                           |
| AS          | 1.1AS       | F20/F60                   | 1.1            | Violet-blue | 1.1AS                 | R09 (1.12AS)<br>360053173                                 |
|             | 1.11AS      | Serial number before      |                |             |                       |                                                           |
|             | 1.12AS      | 25xxxxxJ                  |                |             |                       |                                                           |
|             | 2.000AS     | F20/F60                   | 2.0AS          | Green       | 2.000AS               | R23 (2.0106AS)<br>360054617                               |
|             | 2.0100AS    | Serial number 45xxxxxJ or |                |             |                       |                                                           |
| 2.0106AS    | later *1    |                           |                |             |                       |                                                           |
| US          | 2.0201US    | F10/F20/F40/F60           | 2.0US          | Red         | 2.020US               | R19 (2.0206US)<br>360054608                               |
|             | 2.0206US    |                           |                |             |                       |                                                           |
| UK          | 2.0204UK    | F10/F20/F40/F60           | 2.0UK          | Brown       | 2.020UK               | R20 (2.0206UK)<br>360054609                               |
|             | 2.0206UK    |                           |                |             |                       |                                                           |

## **7. Disassembling/Reassembling Procedures**







Be sure to disconnect the AC adapter and turn OFF the BATTERY button before disassembling the gigabeat.

As long as power is supplied to the gigabeat by the AC adapter or BATTERY, the LCD and almost all the ICs are powered even during power OFF. Therefore, the AC adapter and BATTERY must be disconnected before repairing the gigabeat.







When the BATTERY button is set to “OFF”, power supply from the BATTERY is shut off and all the settings become default. This is the same state as where the BATTERY is disconnected.





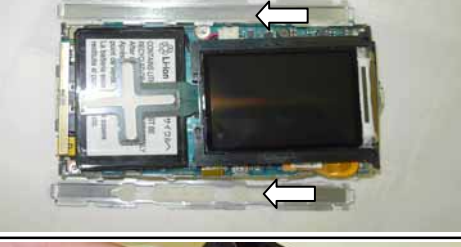

### 7.1. Disassembling Procedures

| Step | Photo                                                                               | Description                                                                                                             | Note | Tool                                   |
|------|-------------------------------------------------------------------------------------|-------------------------------------------------------------------------------------------------------------------------|------|----------------------------------------|
| 1    |    | Turn off the battery switch of the main unit indicated by the arrow.                                                    |      |                                        |
| 2    |    | Insert the flathead screwdriver between the side panel and top panel. Lift up the top panel by pushing the screwdriver. |      | Screwdriver (blade width: about 1.8mm) |
| 3    |   | The lock will be released and the upper gap will be made.                                                               |      |                                        |
| 4    |  | Insert the flathead screwdriver into the gap.                                                                           |      |                                        |
| 5    |  | Release the center lock and remove the top panel.                                                                       |      |                                        |
| 6    |  | Similarly, remove the bottom panel.                                                                                     |      |                                        |



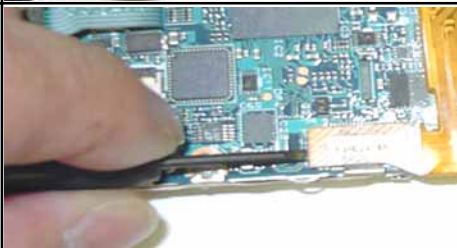

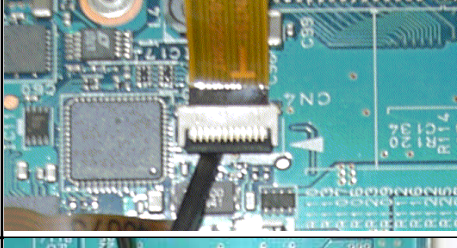
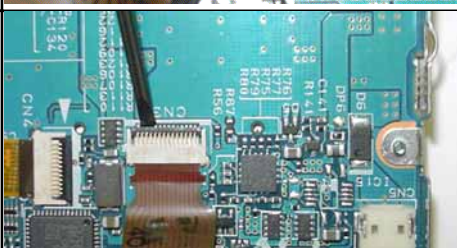
Disassembling Procedures

| Step | Photo                                                                               | Description                                                                                                                                 | Note                                            | Tool                 |
|------|-------------------------------------------------------------------------------------|---------------------------------------------------------------------------------------------------------------------------------------------|-------------------------------------------------|----------------------|
| 7    |    | A view of the bottom side after removing the bottom panel.                                                                                  |                                                 |                      |
| 8    |    | Remove four screws fixing the front and rear panels.                                                                                        |                                                 | Phillips screwdriver |
| 9    |    | Hold the side panel, slide the front panel in the bottom direction (indicated by the arrow), and then release the lock.                     |                                                 |                      |
| 10   |  | Remove the front panel. (Remove the cross key from the front panel.)                                                                        | Hold the cross key and lift up the front panel. |                      |
| 11   |  | Remove the rear panel with the same procedure as the front panel.                                                                           |                                                 |                      |
| 12   |  | Remove the side panel. Hold the main unit by hand, slide the side panel in the direction indicated by the arrow, and then release the lock. |                                                 |                      |
| 13   |  | Remove the LCD. Lift up the LCD frame.                                                                                                      |                                                 |                      |

Disassembling Procedures

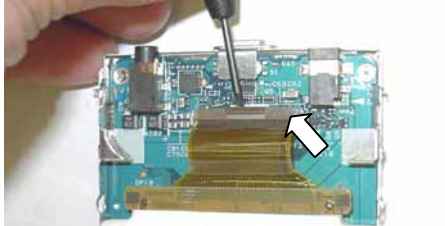

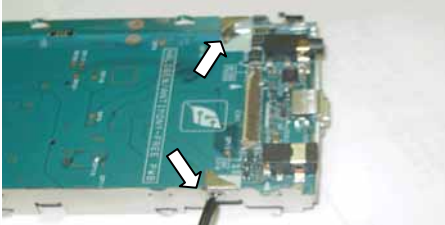
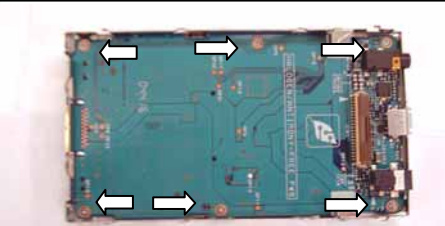
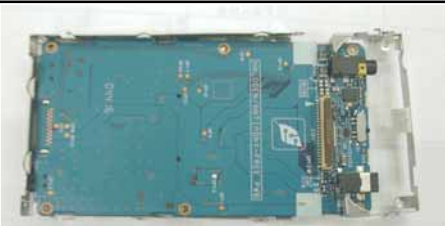
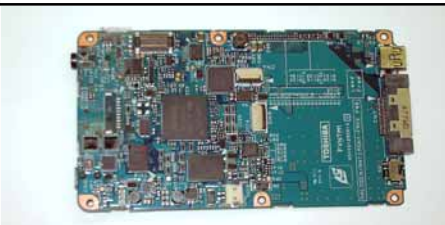
| Step | Photo                                                                               | Description                                                                                      | Note                                                                                                    | Tool                 |
|------|-------------------------------------------------------------------------------------|--------------------------------------------------------------------------------------------------|---------------------------------------------------------------------------------------------------------|----------------------|
| 14   |    | Disconnect the backlight cable (CN6).                                                            | Lift up the lock lever on the side opposite to the cable insertion direction, and release the lock.     | Flathead screwdriver |
| 15   |    | Lift up the PJ2 connector with the flathead screwdriver, and disconnect it.                      |                                                                                                         | Flathead screwdriver |
| 16   |    | A view of the LCD Assembly removed.                                                              |                                                                                                         |                      |
| 17   |   | Release the lock of the connector section and disconnect the cable from the side panel SW. (CN4) | Lift up the lock lever (black) of the connector with the flathead screwdriver and release the lock.     | Flathead screwdriver |
| 18   |  | Release the lock of the connector section and disconnect the cross key cable. (CN3)              | Lift up the lock lever (black) of the connector with the flathead screwdriver and release the lock.     | Flathead screwdriver |
| 19   |  | A view of the cross key removed.                                                                 |                                                                                                         |                      |
| 20   |  | Remove the HDD.                                                                                  | Insert the flathead screwdriver between the P.C. board and the HDD shock absorber, and lift up the HDD. | Flathead screwdriver |

Disassembling Procedures



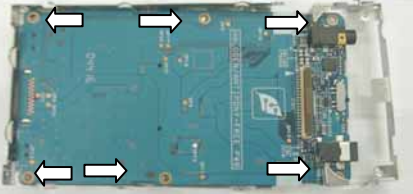
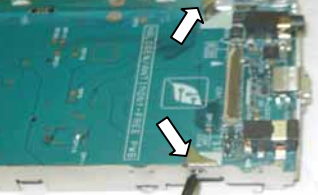
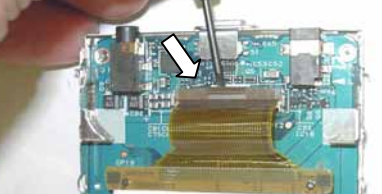

| Step | Photo                                                                               | Description                                                                    | Note                                                | Tool                 |
|------|-------------------------------------------------------------------------------------|--------------------------------------------------------------------------------|-----------------------------------------------------|----------------------|
| 21   |    | Disconnect the cable from the connector, and remove the HDD.                   | Lift up the lock lever of CN1 and release the lock. |                      |
| 22   |    | A view of the HDD removed from the chassis frame.                              |                                                     |                      |
| 23   |    | Remove the P.C. Board. Remove two screws from the frame fixing the P.C. Board. |                                                     | Phillips screwdriver |
| 24   |   | Remove six screws fixing the P.C. Board.                                       |                                                     | Phillips screwdriver |
| 25   |  | A view of the P.C. Board removed from the frame.                               |                                                     |                      |
| 26   |  | A view of the P.C. Board removed.                                              |                                                     |                      |
| 27   |  | Remove the hold button from the frame.                                         |                                                     |                      |

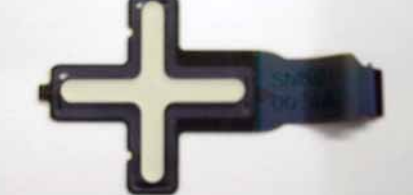
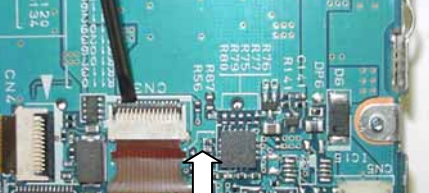
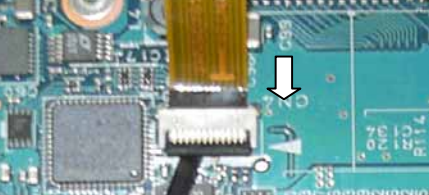
Disassembling Procedures



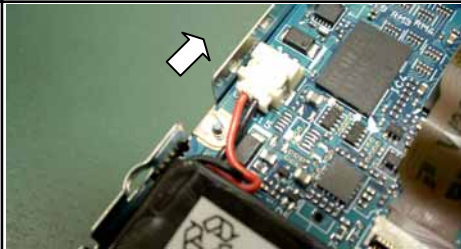

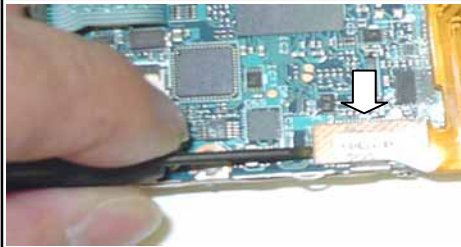
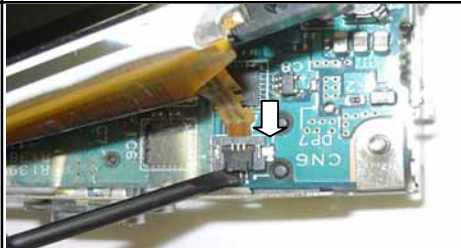

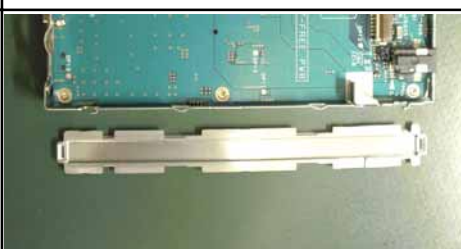
## 7.2. Reassembling Procedures

| Step | Photo                                                                               | Description                                                                                                              | Note                                                                     | Tool                 |
|------|-------------------------------------------------------------------------------------|--------------------------------------------------------------------------------------------------------------------------|--------------------------------------------------------------------------|----------------------|
| 1    |    | Fix the P.C. Board to two frames.                                                                                        | Tighten six screws.                                                      | Phillips screwdriver |
| 2    |    | Tighten two screws to fix the frame.                                                                                     |                                                                          |                      |
| 3    |    | Insert the HDD cable and push the lock lever toward the P.C. Board to lock it.                                           | Confirm that the lock lever is lifted up.                                |                      |
| 4    |  | Push the HDD in the direction indicated by the arrow and place it inside the frame.                                      |                                                                          | Screwdriver          |
| 5    |  | Install the cross key.                                                                                                   |                                                                          |                      |
| 6    |  | Insert the cross key into the connector CN3 and push the lock lever toward the P.C. Board to lock it.                    | Confirm that the lock lever is lifted up and released before attachment. | Flathead screwdriver |
| 7    |  | Insert the cable from the side panel SW into the connector CN4 and push the lock lever toward the P.C. Board to lock it. | Confirm that the lock lever is lifted up and released before attachment. | Flathead screwdriver |

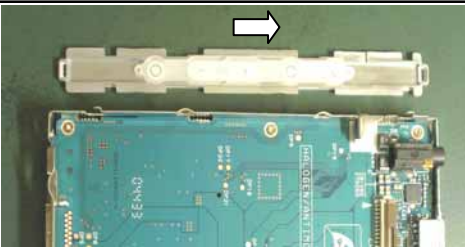
Reassembling Procedures

| Step | Photo                                                                               | Description                                                                                                                 | Note                                                                 | Tool                 |
|------|-------------------------------------------------------------------------------------|-----------------------------------------------------------------------------------------------------------------------------|----------------------------------------------------------------------|----------------------|
| 8    |    | Connect the battery to the connector CN5.                                                                                   | Draw the battery cable not to touch the screw fixing the P.C. Board. |                      |
| 9    |    | Install the LCD Assembly.                                                                                                   |                                                                      |                      |
| 10   |    | Position and insert the cable PJ2 from the LCD.                                                                             | Insert it fully.                                                     |                      |
| 11   |   |                                                                                                                             |                                                                      | Flathead screwdriver |
| 12   |  | Insert the frame Assembly. (Insert the headphone terminal section, and then insert the cradle connection terminal section.) |                                                                      |                      |
| 13   |  | Insert the frame Assembly. (Inserting section of the cradle connection terminal.)                                           |                                                                      |                      |
| 14   |  | Install the SW panel.                                                                                                       |                                                                      |                      |

Reassembling Procedures

| Step | Photo                                                                               | Description                                                                                      | Note                                                                                                        | Tool                 |
|------|-------------------------------------------------------------------------------------|--------------------------------------------------------------------------------------------------|-------------------------------------------------------------------------------------------------------------|----------------------|
| 15   |    | Install the side panel.                                                                          | Slide the side panel in the direction indicated by the arrow with the lock guide aligned, and then fix it.  |                      |
| 16   |    | Install the rear cover.                                                                          | Slide the rear cover in the direction indicated by the arrow with the lock guide aligned, and then fix it.  |                      |
| 17   |    | Install the front cover. Slide the battery SW knob and confirm that the battery SW is operating. | Slide the front cover in the direction indicated by the arrow with the lock guide aligned, and then fix it. |                      |
| 18   |   | Fix the front and rear covers. (Tighten four screws.)                                            |                                                                                                             | Phillips screwdriver |
| 19   |  | Install the top cover. (Fix the lock of one side and press it with your finger.)                 |                                                                                                             |                      |
| 20   |  | Install the bottom cover. (Fix the lock of one side and press it with your finger.)              |                                                                                                             |                      |
| 21   |  | The assembly is complete.                                                                        |                                                                                                             |                      |

Reassembling Procedures

## 8. Exploded view

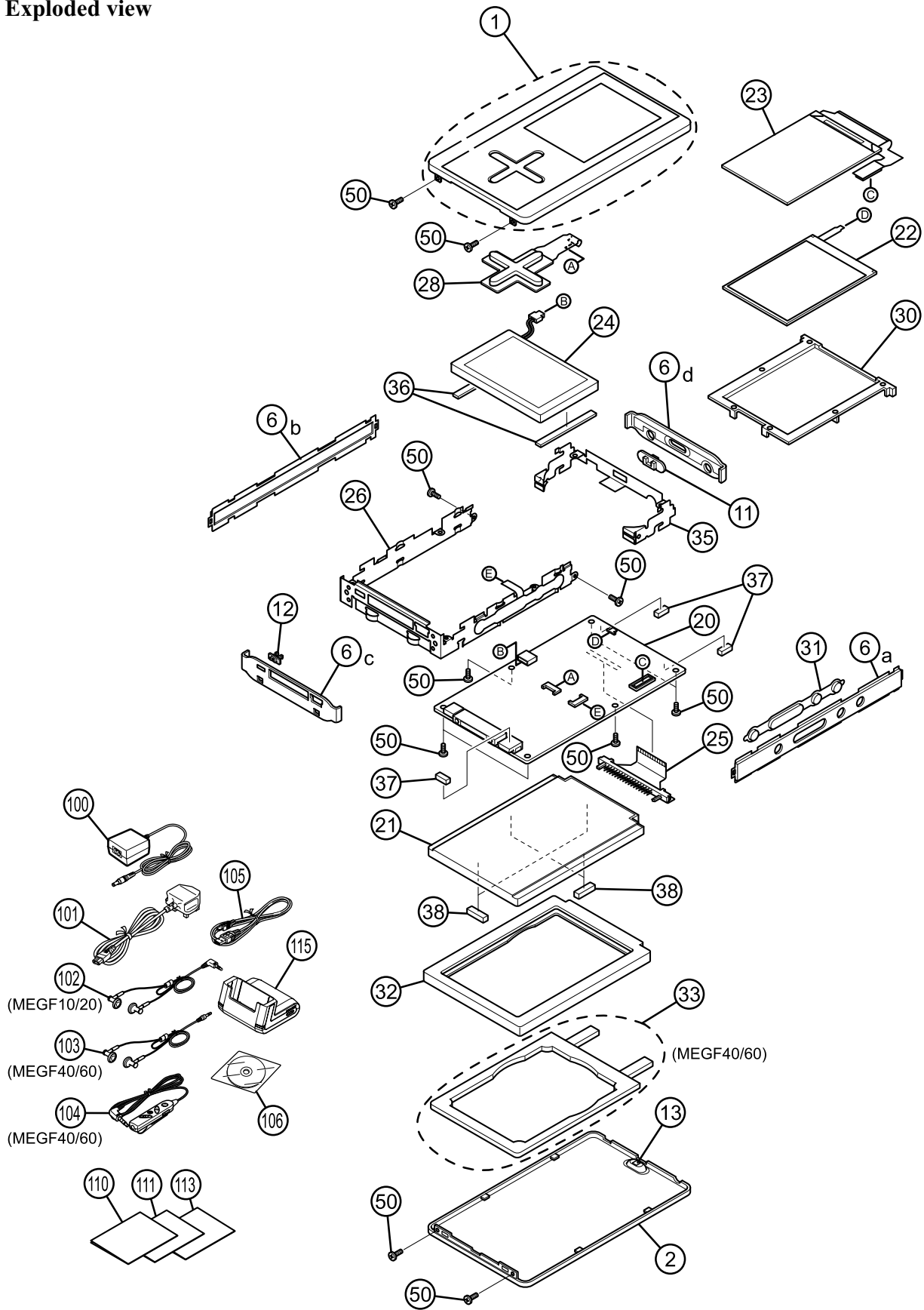



## 9. Parts List

gigabeat-UK (MEGF 10S/20S/40S/60S)

| Location No. | P-Sevice No. | Parts No.       | Description                      | Model   | Remarks                 |
|--------------|--------------|-----------------|----------------------------------|---------|-------------------------|
| 1            | P000441140   | AM0006271340    | COVER ASSY-PMMR SILVER-A         | 10S     |                         |
|              | P000441080   | AM0006271110    | COVER ASSY-HAIR-S                | 20S     |                         |
|              | P000441090   | AM0006271120    | COVER ASSY-HAIR-GO               | 40S     |                         |
|              | P000441100   | AM0006271130    | COVER ASSY-HAIR-GR               | 60S     |                         |
| 2            | P000441580   | PM0019226500    | BASE-A-10C-UK                    | 10S     |                         |
|              | P000441590   | PM0019226510    | BASE-A-20C-UK                    | 20S     |                         |
|              | P000441670   | PM0019546500    | BASE-A-40C-UK                    | 40S     |                         |
|              | P000441680   | PM0019546510    | BASE-A-60C-UK                    | 60S     |                         |
| 6            | P000441180   | AM0006397300    | SIDE PANEL SET SILVER P          | ALL     | 1Set(6a-6d)             |
| 11           | P000441620   | PM0019235100    | HOLD BUTTON                      | ALL     |                         |
| 12           | P000425080   | PM0019236100    | BATTERY BUTTON                   | ALL     |                         |
| 13           | P000425090   | PM0019237100    | STRAP HOLDER-1                   | 10S/20S |                         |
|              | P000428640   | PM0019699100    | STRAP HOLDER-2                   | 40S/60S |                         |
| 20           | P000424910   | G8FC0000S410010 | MAIN PCB ASSY                    | ALL     |                         |
| 21           | P000441870   | HDD1488CZR      | HDD 10GB ROHS                    | 10S     |                         |
|              | P000441490   | HDD1488CZK      | HDD 20GB ROHS                    | 20S     |                         |
|              | P000441500   | HDD1524GZF03    | HDD 40GB                         | 40S     |                         |
|              | P000441510   | HDD1544CZL      | HDD 60GB ROHS                    | 60S     |                         |
| 22           | P000424940   | GDM330000061    | LCD-BACKLIGHT-UNIT CBL1510A      | ALL     |                         |
| 23           | P000424950   | GDM330000063    | LCD LTM022D311                   | ALL     |                         |
| 24           | P000424880   | G71C0004N110    | LI-ION BATTERY MK-11-2720        | ALL     |                         |
| 25           | P000424860   | G28C00021110    | HDD-FLEXIBLE-CABLE TSGZ-017MS-0B | ALL     |                         |
| 26           | P000433620   | PM0019241100A   | FRAME ASSY                       | ALL     | Seet Switch is attached |
| 28           | P000424890   | G83C0004Q110    | FEATHER-TOUCH-SENSOR SMK010004A  | ALL     |                         |
| 30           | P000425100   | PM0019238100    | LCD FRAME                        | ALL     |                         |
| 31           | P000425110   | PM0019239100    | SWITCH BUTTON                    | ALL     |                         |
| 32           | P000425120   | PM0019240100    | HDD RUBBER                       | ALL     |                         |
| 33           | P000441720   | PM0019547100    | HDD SPACER                       | 40S/60S |                         |
| 35           | P000425140   | PM0019243100    | REAR PLATE                       | ALL     |                         |
| 36           | P000441730   | PM0020203100    | BATTERY RUBBER                   | ALL     |                         |
| 37           | P000441740   | PM0020474100    | INS CON PLATE                    | ALL     |                         |
| 38           | P000441520   | PM0003333020    | HDD PROTECTION                   | 40S/60S |                         |
| 50           | P000404330   | PM0012147010    | SCREW M1.4X2.5                   | ALL     |                         |
| 100          | P000404060   | G71C0002F110    | AC-ADAPTER ADP-15HH-A            | ALL     |                         |
| 101          | P000441250   | GDM900000746    | NR BS AC-CORD SET                | ALL     |                         |
| 102          | P000441230   | GDM300000196    | HEADPHONE-GRAY-1.2M-US TSB005-2  | 10S/20S |                         |
| 103          | P000441220   | GDM300000195    | HEADPHONE-GRAY-0.5M-US TSB005-1  | 40S/60S |                         |
| 104          | P000441210   | G83C0005N110    | WIRED REMOTE CONTROLLER GRAY US  | 40S/60S |                         |
| 105          | P000404170   | GDM900000244    | USB MINI CABLE                   | ALL     |                         |
| 106          | P000441260   | GX0C000C1610    | VENETIAN-UK CD-ROM VER2.0UK      | ALL     |                         |
| 110          | P000441360   | GX1C0007UK10    | VENETIAN-UK OWNERS MANUAL-EC 2   | ALL     |                         |
| 111          | P000441370   | GX1C0007UL10    | VENETIAN-UK APPLI MANUAL-EC 2    | ALL     |                         |
| 113          | P000441380   | GX1C0007UM10    | VENETIAN-UK QUICK-START-EC 2     | ALL     |                         |
| 115          | P000441770   | G8FC0000SJ10010 | CRADLE-MEGBCS13-US               | 10S/20S |                         |
|              | P000441790   | G8FC0000SP10010 | CRADLE-MEGBCS14-US               | 40S/60S |                         |

## Specifications

|                          |                                                                                                                                                                                                                                                                                                                                                                                                                                                                                                                                                                                                                                                                                                                                                         |                                                                                      |
|--------------------------|---------------------------------------------------------------------------------------------------------------------------------------------------------------------------------------------------------------------------------------------------------------------------------------------------------------------------------------------------------------------------------------------------------------------------------------------------------------------------------------------------------------------------------------------------------------------------------------------------------------------------------------------------------------------------------------------------------------------------------------------------------|--------------------------------------------------------------------------------------|
| Built-in battery         | Rechargeable lithium-ion battery                                                                                                                                                                                                                                                                                                                                                                                                                                                                                                                                                                                                                                                                                                                        |                                                                                      |
| Weight                   | MEGF60 and MEGF40                                                                                                                                                                                                                                                                                                                                                                                                                                                                                                                                                                                                                                                                                                                                       | Approx. 170 g (main unit only)                                                       |
|                          | MEGF20 and MEGF10                                                                                                                                                                                                                                                                                                                                                                                                                                                                                                                                                                                                                                                                                                                                       | Approx. 160 g (main unit only)                                                       |
| External dimensions      | MEGF60 and MEGF40                                                                                                                                                                                                                                                                                                                                                                                                                                                                                                                                                                                                                                                                                                                                       | Approx. 63 mm x 19 mm x 106 mm<br>(width x height x depth), excluding<br>projections |
|                          | MEGF20 and MEGF10                                                                                                                                                                                                                                                                                                                                                                                                                                                                                                                                                                                                                                                                                                                                       | Approx. 63mm x 16 mm x 106 mm<br>(width x height x depth), excluding<br>projections  |
| Audio format             | <ul style="list-style-type: none"><li>● MPEG-1 Audio Layer 3 (MP3)</li><li>● Windows Media Audio (WMA)</li><li>● PCM (WAV)</li></ul>                                                                                                                                                                                                                                                                                                                                                                                                                                                                                                                                                                                                                    |                                                                                      |
| Sampling frequency       | 22.05 to 48 kHz                                                                                                                                                                                                                                                                                                                                                                                                                                                                                                                                                                                                                                                                                                                                         |                                                                                      |
| Bit rate                 | 16 to 320 kbps                                                                                                                                                                                                                                                                                                                                                                                                                                                                                                                                                                                                                                                                                                                                          |                                                                                      |
| Recording media          | MEGF60                                                                                                                                                                                                                                                                                                                                                                                                                                                                                                                                                                                                                                                                                                                                                  | Internal hard disk 60 GB*                                                            |
|                          | MEGF40                                                                                                                                                                                                                                                                                                                                                                                                                                                                                                                                                                                                                                                                                                                                                  | Internal hard disk 40 GB*                                                            |
|                          | MEGF20                                                                                                                                                                                                                                                                                                                                                                                                                                                                                                                                                                                                                                                                                                                                                  | Internal hard disk 20 GB*                                                            |
|                          | MEGF10                                                                                                                                                                                                                                                                                                                                                                                                                                                                                                                                                                                                                                                                                                                                                  | Internal hard disk 10 GB*                                                            |
| Maximum recording time   | MEGF60                                                                                                                                                                                                                                                                                                                                                                                                                                                                                                                                                                                                                                                                                                                                                  | Approx. 996** hours (at 128 kbps bit rate)                                           |
|                          | MEGF40                                                                                                                                                                                                                                                                                                                                                                                                                                                                                                                                                                                                                                                                                                                                                  | Approx. 664** hours (at 128 kbps bit rate)                                           |
|                          | MEGF20                                                                                                                                                                                                                                                                                                                                                                                                                                                                                                                                                                                                                                                                                                                                                  | Approx. 332** hours (at 128 kbps bit rate)                                           |
|                          | MEGF10                                                                                                                                                                                                                                                                                                                                                                                                                                                                                                                                                                                                                                                                                                                                                  | Approx. 166** hours (at 128 kbps bit rate)                                           |
| Continuous playback time | Approx. 16 hours** (Built-in battery)                                                                                                                                                                                                                                                                                                                                                                                                                                                                                                                                                                                                                                                                                                                   |                                                                                      |
|                          | Assuming 128 kbps, 44.1 kHz WMA tracks (excluding content protected with Windows Media DRM 10), in normal temperature (25°C), backlight unlit, volume adjusted to center<br>The continuous playback time is a reference value but is not guaranteed, since the actual playback time will vary depending on the operating condition, ambient operating temperature, the number of times the built-battery has been recharged, etc.<br>Even under allowable operating conditions, using the gigabeat at low temperature will result in a reduction of the maximum continuous playback time.<br>WAV tracks consume a lot of battery power, so the continuous playback time of WAV tracks are significantly shorter than when MP3 or WMA tracks are played. |                                                                                      |
| Operating conditions     | Temperature: 5 to 35°C, Humidity: 30 to 80% (RH) (No condensation)                                                                                                                                                                                                                                                                                                                                                                                                                                                                                                                                                                                                                                                                                      |                                                                                      |
| USB port                 | USB2.0/USB1.1                                                                                                                                                                                                                                                                                                                                                                                                                                                                                                                                                                                                                                                                                                                                           |                                                                                      |
| Headphone jack           | 3.5-mm jack/stereo type                                                                                                                                                                                                                                                                                                                                                                                                                                                                                                                                                                                                                                                                                                                                 |                                                                                      |
|                          | Load impedance 16 Ω                                                                                                                                                                                                                                                                                                                                                                                                                                                                                                                                                                                                                                                                                                                                     |                                                                                      |
| S/N ratio                | 95 dB or higher                                                                                                                                                                                                                                                                                                                                                                                                                                                                                                                                                                                                                                                                                                                                         |                                                                                      |
| AC adapter               | Input power condition: 100 to 240VAC, 50/60Hz                                                                                                                                                                                                                                                                                                                                                                                                                                                                                                                                                                                                                                                                                                           |                                                                                      |
|                          | Rated output: 5V DC, 3 A                                                                                                                                                                                                                                                                                                                                                                                                                                                                                                                                                                                                                                                                                                                                |                                                                                      |
| Colour panel***          | 2.2 inch diagonal QVGA low temperature polysilicon TFT colour panel                                                                                                                                                                                                                                                                                                                                                                                                                                                                                                                                                                                                                                                                                     |                                                                                      |

## Specifications (Continued from the previous page)

\* 1 Gigabyte = 1 billion bytes when referring to hard drive capacity. The available storage capacity will also be less because the product includes pre-installed firmware and some sample contents.

\*\* These values are for reference purposes only and may vary.

\*\*\*The colour LCD is made with extremely high-precision technology. There may be the existence of display (pixels) that might not light or might be lit all the time; however, please note that this does not constitute malfunction of the product and is not covered by your warranty.

### ■ Combination of Sampling Frequency and Bit Rate

The tracks that can be played on the gigabeat have the following combinations of sampling frequency and bit rate. Tracks with another combination may not play properly.

- MP3 (stereo)
  - Sampling frequency: 22.05, 44.1, 48 kHz
  - Bit rate: 32 to 320 kbps
- MP3 (mono)
  - Sampling frequency: 22.05, 44.1, 48 kHz
  - Bit rate: 16 to 64 kbps
- WMA (stereo)
  - Sampling frequency: 22.05/44.1 kHz
  - Bit rate: 32/48 to 192 kbps
- WMA (mono)
  - Sampling frequency: 44.1 kHz
  - Bit rate: 32 kbps
- WAV (stereo/mono)
  - Sampling frequency: 22.05, 44.1, 48 kHz
  - Bits: 16 bits

---

### NOTE

This product complies with the above specifications.  
Designs and specifications are subject to change without notice.  
This product may not be compatible with features and/or specifications that may be added in the future.

The illustrations and screen displays appearing in this manual may differ somewhat from the actual appearance for the purpose of easy viewing.

The display position and other aspects of the icons are subject to change.

---

## System Requirements for gigabeat room

Applicable PC: IBM PC/AT compatible

- OS: Microsoft® Windows® XP Home Edition  
Microsoft® Windows® XP Professional
- CPU: Pentium® II 300MHz or faster (Pentium® III 1GHz or faster recommended)
- Memory: 128 MB or more
- Available hard disk space: 100 MB, excluding tracks
- USB port
- CD-ROM drive
- Internet Explorer 5.01 or later (This is correct as of February 2005. TOSHIBA cannot assure that gigabeat room will function properly with future Internet Explorer releases.)
- Windows Media® Player 10 or later

---

### NOTE

TOSHIBA cannot guarantee that gigabeat room will function properly on all PCs.

TOSHIBA cannot guarantee that gigabeat room will function properly on a PC assembled from generic parts.

If you upgrade the OS, uninstall gigabeat room, before beginning the OS upgrade and then reinstall gigabeat room when the OS upgrade is completed.

The user must log in as "Administrator" to use gigabeat room in Windows XP Home Edition or Windows XP Professional.

TOSHIBA cannot guarantee that the gigabeat room will function properly in a dual-CPU system running Windows XP Professional, or with Windows XP Home Edition/Professional in a system incorporating an Intel Pentium 4 processor using Hyper-Threading Technology.

Due to security system conflicts, the use of gigabeat room in conjunction with an application using another security system may cause problems such as a frozen application or forced system restart.

gigabeat room and TOSHIBA Audio Application or TOSHIBA Audio Manager cannot run simultaneously.

When two or more applications among gigabeat room, TOSHIBA Audio Application, and TOSHIBA Audio Manager have been installed and one of these applications is uninstalled, the other software might cease to function. If this happens, insert the CD-ROMs of the affected software applications into the PC and reinstall them.

---

# **TOSHIBA CORPORATION**

1 1, SHIBAURA 1 CHOME, MINATO KU, TOKYO 105 8001, JAPAN