

6150, 6250, 6300, 6500

POWER AMPLIFIERS

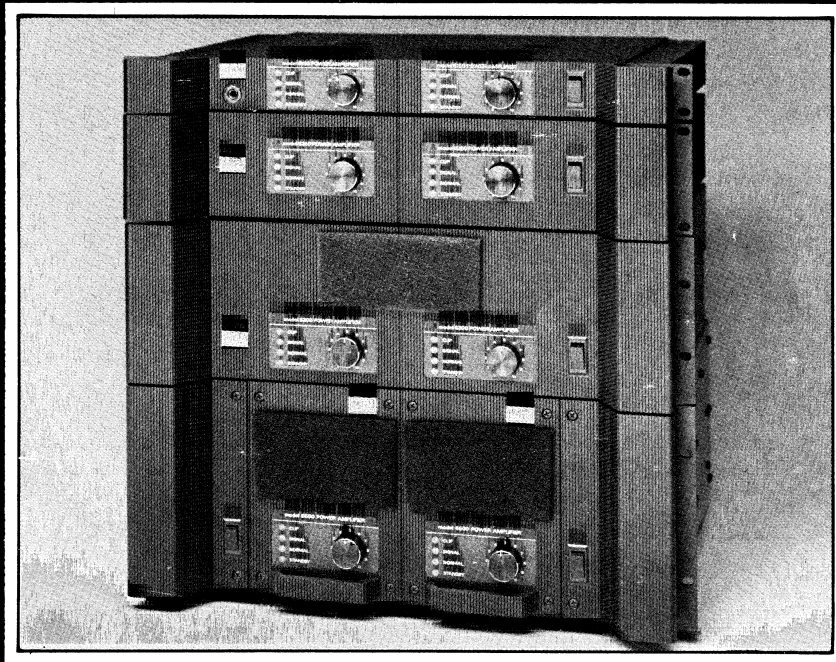

FEATURES:

Active, balanced input circuitry.

Fully complementary output sections.

Standby mode/speaker disconnect protection.

Inputs are balanced bridging XL-type and 6.3 mm (1/4 in) phone jacks (may be operated balanced and unbalanced).

Outputs are heavy duty five-way binding posts. A separate back panel bridge switch is provided for convenient high power mono operation.

Designed for the needs of today's demanding world of professional sound, the UREI power amplifiers are rugged, reliable and conservatively rated. From 80 watts/channel to 275 watts/channel (into 8 ohms), the UREI amplifiers will deliver superb sound in the auditorium, arena and control room.

Each of the UREI amplifiers is designed with the same philosophy. Instead of the common "fix it with feedback" amplifier design approach, UREI engineers have developed an amplifier topology with relatively low loop gain which is highly linear without feedback. Only a small amount of overall negative feedback is used to set the gain and establish the operating point. Frequency compensation in the feedback path and input filtering are calculated to provide an open-loop bandwidth only five



UREI
ELECTRONIC
PRODUCTS

times the closed-loop bandwidth. Intra-loop signal overshoots are suppressed, so that problems of transient intermodulation and slew-rate distortion are eliminated.

Most two-channel amplifiers use a common power supply for both channels. The UREI 6250 and 6300 power amplifiers have split power supplies with separate energy storage capacitors to provide better low frequency transient handling and less crosstalk than conventional single-supply designs.

The UREI 6500 has two totally independent power supplies, each with its own massive transformer and energy storage.

Each UREI power amplifier uses multiple 200 watt output transistors in a full complementary configuration for low distortion and high reliability. The rated power of each amplifier at 8 ohms is typically less than 25% of the output devices' dissipation capacity, thus insuring consistently reliable performance under extreme conditions.

All UREI amplifiers are fully protected against short circuits and open circuits, and can handle highly reactive loads with no difficulty. Relay protection guards the loudspeakers from abnormal low frequency transients, power surges or DC offset. A *Standby* indicator LED on the front panel lights when this protection is activated as well as during power-up and power-down muting. Additional front panel LED indicators denote *Normal* operating conditions, *Signal* presence, and *Clip* levels.

Each UREI power amplifier may be easily operated in bridged monaural mode for even higher power in a small space: Bridging is activated by a switch on the rear panel to avoid accidental operation and no internal modifications are required.

All UREI amplifiers have active differential input circuits which offer the noise rejection of input transformers without attendant transformer problems. Each input has two separate connectors: a three conductor 6.3 mm (¼ in) jack which automatically grounds one side of the differential input if a two conductor plug is used, and a three pin XL-type jack.

Speaker outputs are heavy-duty five-way binding posts, spaced 19 mm (¾ in) apart, so that bridged as well as standard connections may be made with standard twin banana plugs, bare wire or terminal lugs.

The Model 6500 features UREI's patented Conductor Compensation, which effectively eliminates the problems originating in loudspeaker wiring by including the speaker leads in the main feedback loop of the amplifier. The result is extremely high damping factor and outstanding transient response at the loudspeaker terminals, not just at the amplifier output.

Conductor Compensation is licensed exclusively to UREI by W. Turner, U.S. Patent #4,236,118.

UREI amplifiers are built for the rigors of touring sound systems. Their solid heat sinks, rigid chassis construction and massive mounting extrusions will keep them operating under the extreme conditions inevitably found in portable reinforcement.

The Model 6500 has two separate amplifier modules, each of which plugs in from the front of the amplifier chassis. In case of field problems, an amplifier module may be exchanged in less than one minute, using only a Phillips-type screwdriver, without removing the amplifier from the rack or even turning off the other channel.

Models 6500 and 6300 are fan cooled, and foam filters are provided on the front panels to keep dust and dirt from interfering with amplifier cooling. Model 6500 has two separate continuously variable speed fans, one for each channel.

SPECIFICATIONS COMMON TO ALL MODELS

Input:	Balanced bridging differential amplifier.
Input Impedance:	40k ohms, used as balanced input. 20k ohms, used as unbalanced (single ended) input.
Input Sensitivity:	1.1 V for maximum output into 8 ohm load.
Maximum Input Level:	+20 dB (7.75 V rms).
Voltage Gain:	Variable: max. 32 dB (40 times).
Hum and Noise Level:	-100 dB below rated output (15.7 kHz noise bandwidth).
Frequency Response:	+0, -1 dB; 20 Hz to 20 kHz, at any power level up to rated output.
Rise Time:	Less than 7 μ s.
Slew Rate:	50 V/ μ s (into 8 ohm load).
Intermodulation Distortion:	Less than 0.05% total, 250 milliwatts + rated output (60 Hz and 7 kHz, 4:1 ratio).
Channel Separation:	>60 dB (input shorted).
Damping Factor:	With 8 ohm load, greater than 200 at any frequency from 20 Hz to 1 kHz, greater than 70 @ 20 kHz.
Power Requirements:	100/120/200/220/240 VAC (strappable), 50/60 Hz.

MODEL	6150	6250	6300	6500
OUTPUT POWER, 20 Hz-20 kHz, PER CHANNEL*:				
8 ohm stereo	80 W	150 W	225 W	275 W (<0.1% THD)
4 ohm stereo	80 W	200 W	380 W	450 W (<0.2% THD)
2 ohm stereo	NA	NA	NA	600 W (<0.5% THD)
8 ohm bridged	150 W	400 W	750 W	900 W (<0.2% THD)
4 ohm bridged	NA	NA	NA	1200 W (<0.5% THD)
OUTPUT POWER AT CLIPPING**				
8 ohm stereo	100 W	175 W	310 W	360 W
4 ohm stereo	110 W	270 W	500 W	580 W
2 ohm stereo	NA	NA	NA	800 W
8 ohm bridged	220 W	540 W	1000 W	1160 W
4 ohm bridged	NA	NA	NA	1600 W
DIMENSIONS	44 x 483 mm (1 3/4 x 19 in)	89 x 483 mm (3 1/2 x 19 in)	133 x 483 mm (5 1/4 x 19 in)	178 x 483 mm (7 x 19 in)
DEPTH behind front panel	356 mm (14 in)	356 mm (14 in)	356 mm (14 in)	406 mm (16 in)
NET WEIGHT	10 kg (22 lb)	16.3 kg (36 lb)	23.6 kg (52 lb)	38.1 kg (84 lb)
SHIPPING WEIGHT	11.8 kg (26 lb)	17.7 kg (39 lb)	27.2 kg (60 lb)	43.1 kg (95 lb)
Connections:	Input through XLR/QG and 1/4" phone jack. Output through 5-way binding posts. Conductor Compensation feedback through BNC connector. Power through 3-wire AC power cord.			
Controls:	Front panel level controls Front panel mains switches Rear-panel MONO/STEREO switch			
Indicators:	"NORMAL" (green LED) = normal, linear operation. "SIGNAL" (green LED) = indicating that signal is present at output terminals. "CLIP" (red LED) = clipping or nonlinear operation. "STANDBY" (red LED) = speakers automatically disconnected or thermal protection activated.			
Finish:	Panel is 4.76 mm (3/16 in) black anodized aluminum. Chassis is matte black painted steel.			

* Minimum continuous sine wave average power output per channel over a power bandwidth from 20 Hz to 20 kHz. Maximum total harmonic distortion measured at any power level from 250 milliwatts to rated power.

** Output power measured at typical clipping point (1% THD); both channels driven with 1kHz continuous sine wave.

All referenced trademarks are the property of, or licensed by UREI Inc.

BEFORE PROCEEDING WITH COMPLETE UNPACKING AND SETUP,
CONSULT UNPACKING AND INSPECTION INSTRUCTIONS ON PAGE 6

model 6500

MODULAR POWER AMPLIFIER



United Recording Electronics Industries

8460 SAN FERNANDO ROAD, SUN VALLEY, CALIFORNIA 91352

(818) 767-1000

Printed in U.S.A.

© Copyright 1981, UREI

TABLE OF CONTENTS

	PAGE
<u>SECTION I. INTRODUCTION</u>	
1.1 DESCRIPTION	1
1.2 OUTPUT POWER AND DISTORTION SPECIFICATIONS	3
1.3 ELECTRICAL SPECIFICATIONS	3
1.4 PHYSICAL SPECIFICATIONS	4
1.5 CONTROLS	4
1.6 CONNECTIONS	5
 <u>SECTION II. INSPECTION AND INSTALLATION</u>	
2.1 UNPACKING AND INSPECTION	6
2.2 ENVIRONMENTAL CONSIDERATIONS	6
2.3 POWERING	6
2.4 LINE VOLTAGE STRAPPING	7
2.5 EXTERNAL CONNECTIONS	8
2.5.1 INPUT CONNECTIONS, GENERAL	8
2.5.2 INPUT CONNECTIONS, MONO MODE	9
2.5.3 FIVE-WAY BINDING POST OUTPUTS	10
2.5.4 ABOUT OUTPUT POLARITY & BRIDGED MONO CONNECTIONS	10
2.6 IMPEDANCE AND TERMINATION	12
2.7 APPROPRIATELY RATED LOADS	12
2.7.1 IT IS THE USER'S RESPONSIBILITY TO AVOID OVERPOWERING	12
2.7.2 MORE ABOUT LOUDSPEAKER POWER RATINGS	13
2.7.3 SOMETIMES A LARGER AMPLIFIER CAN BE SAFER	14
2.7.4 REMEMBER THE DIVIDING NETWORK	14
2.8 SPEAKER CABLES	15
2.8.1 TYPE OF WIRE	15
2.8.2 CONDUCTOR COMPENSATION	15
2.8.3 DAMPING FACTOR	16
2.8.3 CALCULATING LOSSES IN SPEAKER CABLE	17
 <u>SECTION III. OPERATING INSTRUCTIONS</u>	
3.1 GENERAL	18
3.2 TURN ON AND SYSTEM CHECK	18
3.2.1 A NOTE ON AMPLIFIER COOLING	18
3.3 CLIP AND SIGNAL PRESENT INDICATORS	19
3.3.1 CLIPPING INDICATORS	19
3.3.2 ABOUT SENSITIVITY RATINGS	19
3.3.3 SIGNAL PRESENT INDICATORS	19
3.4 MONO OPERATION	20
 <u>SECTION IV. THEORY OF OPERATION</u>	
4.1 INPUT AMPLIFIER	21
4.2 SIGNAL INDICATOR	21
4.3 SUMMING AMPLIFIER	21

TABLE OF CONTENTS
(Continued)

	PAGE
4.4 VOLTAGE AMPLIFIER	21
4.5 CURRENT AMPLIFIER	21
4.6 OUTPUT PROTECTION	22
4.7 CLIP INDICATOR	22
4.8 RELAY CIRCUIT	22
4.9 FAN CIRCUIT	22
4.10 POWER SUPPLY	22
4.11 CONDUCTOR COMPENSATION	23
 <u>SECTION V. MAINTENANCE</u>	
5.1 GENERAL	24
5.2 REPAIRS AND WARRANTY	24
5.3 AIR FILTERS	24
 <u>SECTION VI. SCHEMATIC DIAGRAM</u>	
	25

SECTION I
INTRODUCTION

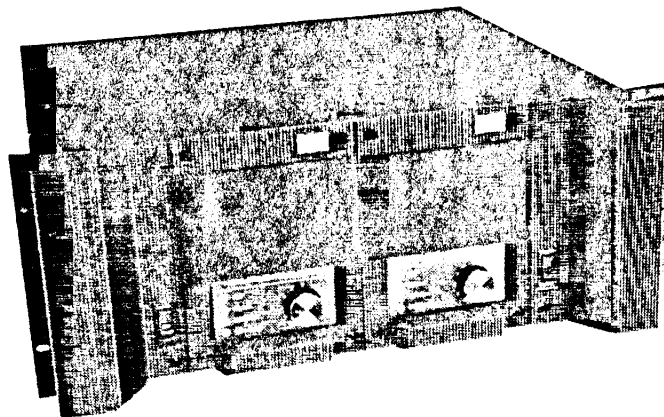

FIGURE 1-1. MODEL 6500 FRONT PANEL.

1.1 DESCRIPTION

The Model 6500 is a two channel professional power amplifier offering significant electronic and mechanical improvements over conventional solid state audio power amplifiers.

In contrast to common "fix it with feedback" amplifier designs, the Model 6500 utilizes only a small amount of negative feedback to set the gain and establish the operating point. Stimulated by W. Marshall Leach's insights (Journal of the AES, issues 7 & 8, 1977) UREI engineers have held open-loop bandwidth to about five times closed-loop bandwidth using frequency compensation in the feedback path combined with input filtering. Without high open loop gain and the requisite large amounts of negative feedback to control it, the Model 6500 avoids heavy lag compensation. In turn, this suppresses intraloop signal overshoots, eliminating transient intermodulation and slew rate distortion. The result, in subjective terms, is that the Model 6500 sounds completely open and natural, regardless of input signal characteristics or output power level.

To avoid interaction between channels, the mainframe of the 6500 has two complete power supplies with separate transformers and extra-large filter capacitors capable of handling three times the normal expected load.

To secure the massive transformers, new mechanical engineering techniques were used. A large section aluminum extrusion, which forms the front panel handles and rack mounting ears, also directly supports the transformers.

The totally modular construction of the front panel dual amplifier assemblies allows easy removal of each channel for inspection or exchange. Each channel's horizontal "flow thru" design features air intake filters which are serviceable from the front panel. An automatic and continuously variable fan speed control in each channel assembly minimizes thermal cycling of power semiconductor

junctions by maintaining even heat-sink temperature. This cooling feature also results in quieter operation.

In addition to double redundant thermal protection features, the Model 6500 also has standby mode/speaker disconnect circuitry activated by initial power-up, power-down, abnormal low frequency transients, or excessive dc offset.

Power output is conservatively rated at 600 watts per channel into 2 ohms, 450 watts into 4 ohms and 275 watts into 8 ohms. With the flip of a switch, the Model 6500 may be operated as a very high power single-channel amplifier rated at 1,200 watts into 4 ohms or 900 watts into 8 ohms (bridged output). Fourteen output transistors are used per channel in a full complementary configuration, each rated at 200 watts. Thus reliability is ensured without resorting to the kind of overly sophisticated protection circuitry that can adversely affect sound quality. Since the amp is ac coupled, dc appearing at the input cannot damage loudspeakers.

Much discussion among technically oriented audio people has centered around speaker feed conductors and the importance of their characteristics relevant to accurate transmission of signals to the speaker. To ensure the maximum integrity of output waveforms delivered to an inherently reactive loudspeaker load, it has been noted that both high damping factor and high peak current capability are necessary to avoid signal degradation, particularly at low frequencies. Speaker wire has significant resistance and, even when fed from a "perfect" amplifier with a "0" output impedance, degrades the system's damping factor. In addition, speaker wires have been shown to produce high frequency transient distortion due to reactive effects and non-constant group delay. It is an important new concept in the design of the Model 6500 to reduce these effects to negligible proportions by including the speaker lines in the main feedback loop of the amplifier. Simple in concept, but complex in execution, the result is dramatic.

UREI has provided a rear-panel feedback connector which will allow detection of the signal at the speaker's terminals. Extremely high damping factor and near-perfect transient response are now obtainable at the loudspeaker. The negative effects of the feed conductors no longer need to contribute to signal degradation.

Each channel is provided with a gain control and four LED's, two of which indicate amplifier status and two of which indicate signal level. Inputs are connected to either XLR/QG connectors or three-conductor 6.3 mm (1/4 in) phone jacks. The input circuit is a balanced, bridging differential amplifier, and may be operated with an unbalanced line. Outputs are made via convenient, reliable high-current five-way binding posts. While operation is very straightforward, a thorough understanding of the Model 6500 Power Amplifier can only benefit the user, so careful reading of this manual is recommended.

1.2 OUTPUT POWER AND DISTORTION SPECIFICATIONS

STEREO MODE: 275 watts minimum continuous sine wave (8 ohm load, each channel) average power output with both channels driving 8 ohms over a power bandwidth from 20 Hz to 20 kHz. The maximum total harmonic distortion at any power level from 250 milliwatts to 275 watts is less than 0.1%.

STEREO MODE: 450 watts minimum continuous sine wave (4 ohm load, each channel) average power output over a power bandwidth from 20 Hz to 20 kHz. The maximum total harmonic distortion at any power level from 250 milliwatts to 450 watts is less than 0.2%.

STEREO MODE: 600 watts minimum continuous sine wave (2 ohm load, each channel) average power output over a power bandwidth from 20 Hz to 20 kHz. The maximum total harmonic distortion at any power level from 250 milliwatts to 600 watts is less than 0.5%.

MONO MODE: 900 watts minimum continuous sine wave (8 ohm load) average power output over a power bandwidth from 20 Hz to 20 kHz (MONO switch engaged, channel "A" driven, outputs bridged and driving an 8 ohm load). The maximum total harmonic distortion at any power level from 250 milliwatts to 900 watts is less than 0.2%.

MONO MODE: 1200 watts minimum continuous sine wave (4 ohm load) average power output over a power bandwidth from 20 Hz to 20 kHz. The maximum total harmonic distortion at any power level from 250 milliwatts to 1200 watts is less than 0.5%.

INTERMODULATION DISTORTION: Less than 0.05% total, 250 milliwatts to rated output (60 Hz & 7 kHz, 4:1 ratio).

1.3 ELECTRICAL SPECIFICATIONS

INPUT: Balanced, bridging differential amplifier.

INPUT IMPEDANCE: 40 kohms, used as balanced input.
20 kohms, used as unbalanced (single-ended) input.

MAXIMUM INPUT LEVEL: +20 dB (7.75 V; Ref. 0.775 V rms).*

INPUT SENSITIVITY: 1.1 V for maximum output into 8 ohm load.

VOLTAGE GAIN: Variable; maximum 32 dB (40 times).

FREQUENCY RESPONSE: +0, -1 dB, 20 Hz - 20 kHz.

RISE TIME: Less than 7 μ s.

SLEW RATE: 50 V/ μ s (into 8 ohm load).

OUTPUT IMPEDANCE: Designed for any load impedance of 4 ohms or greater.

CHANNEL SEPARATION: 100 dB at 1 kHz, 80 dB at 20 kHz (input shorted).

DAMPING FACTOR: Greater than 500 at any frequency from 20 Hz to 1 kHz; greater than 70 at 20 kHz; with 8 ohm load.

AC POWER REQUIREMENTS: 100, 120, 200, 220, or 240 VAC (strappable), 50 or 60 Hz.

1.4 PHYSICAL SPECIFICATIONS

DIMENSIONS: 483 mm wide x 178 mm high rack panel; depth behind panel 381 mm. (19 in x 7 in x 15 in).

FINISH: Panel is 4.76 mm (3/16 in) black anodized aluminum extrusion. Chassis is matte black painted steel.

WEIGHT: 40.8 kg (90 lb).

SHIPPING WEIGHT: 45.4 kg (100 lb).

1.5 CONTROLS

INPUT LEVEL: (Each channel) Attenuates the input to the main power stage after the input differential amplifier. From no attenuation to full kill.

*In these specifications, where "dB" refers to a specific level, the 0 dB reference is 0.775 volts rms unless otherwise noted.

- POWER: (Each Channel) Rocker switch on front panel applies AC voltage to the Model 6500 power supply. Closure of the output relays is automatically delayed for a few seconds. Therefore, any possible turn-on transients cannot reach the speaker terminals.
- MONO MODE: Rear panel slide switch defeats "B" channel input and gain control; an input at the "A" channel XLR/QG or phone jack then drives channel "A" in polarity and channel "B" in reverse polarity (output is bridged across the "hot" terminals of each channel).
- STANDBY LED: (Each channel) Indicates power is On, but (Red) output is disconnected by the internal relay. This condition exists for a few seconds after normal turn-on, and in the event of thermal overload or dc voltage at the output.
- NORMAL LED: (Each channel) Indicates power is On, the (Green) output relay is actuated (speaker output on) and the amplifier is operating normally.
- SIGNAL LED: (Each channel) Indicates a signal is applied (Green) to the amplifier input. This LED will be illuminated whenever a -5 dB or higher level input signal is present. It is not affected by the Level control.
- CLIP LED: (Each channel) This LED indicates that the (Red) amplifier is being driven into clipping at any stage past the input stage.

1.6 CONNECTIONS

All connections for input and output are made on the rear panel. Input to each channel is via a three pin XLR/QG connector and a three-conductor 6.3 mm (1/4 in) phone jack, both of which are wired in parallel. Channel outputs are connected to two pairs of five-way binding posts. The posts are spaced so that a dual banana plug can be inserted in each channel's output. A BNC connector near each set of binding posts is used for the Conductor Compensation lead from the speakers. Power is applied through a three-wire (grounded) cord. (See the Installation Instructions in Section 2.5., and Figures 2-2 through 2-6.)

SECTION II
INSPECTION AND INSTALLATION

2.1 UNPACKING AND INSPECTION

Your Model 6500 was carefully packed at the factory, and the container was designed to protect the unit from rough handling. Nevertheless, we recommend careful examination of the shipping carton and its contents for any sign of physical damage which could have occurred in transit.

Save the carton and packing in the unlikely event the unit must be returned for service; if you do not have a carton, call the factory for one before shipping the unit. If damage is evident, do not destroy any of the packing material or the carton, and immediately notify the carrier of a possible claim for damage. Shipping claims must be made by the consignee.

The shipment should include:

Model 6500 Two Channel Power Amplifier

UREI Instruction Manual (this book)

Two-part Warranty Card bearing the same serial number as the Model 6500.

Rack mounting hardware.

2.2 ENVIRONMENTAL CONSIDERATIONS

The amplifier will operate satisfactorily over a range of ambient temperatures from 0°C to +50°C (+32°F to 122°F), and up to 80% non-condensing relative humidity.

If the amplifier is installed in an equipment rack, adequate ventilation must be provided in order to assure longest component life. The built-in fans draw air through the front panel and exhaust it via vents in the rear and side panels; these vents must not be blocked, and the hot air from the interior of the rack should be vented. Furthermore, remember that the Model 6500 is heavy. The rack, especially its mounting rails, should be capable of supporting the amplifier. When a rack is to be transported with a portable sound system, the Model 6500 also should be supported from below; a few pieces of angle iron secured to the sides of the rack will suffice. It is further recommended that the amplifier be placed low in the rack to keep the center of gravity low and thus avoid any tendency for the rack to tip over.

2.3 AC POWER

The Model 6500 may be operated from 100, 120, 200, 220, or 240 VAC mains (50 Hz or 60 Hz, single phase). As indicated in

Section 2.4, the nominal line voltage may be selected by opening the amplifier and restrapping the power transformers.

WARNING

BE SURE TO VERIFY BOTH THE ACTUAL LINE VOLTAGE AND THE STRAPPING OF THE TRANSFORMERS BEFORE CONNECTING THE 6500 TO THE MAINS (if necessary, re-strap the transformers). APPLICATION OF EXCESSIVE VOLTAGE TO THE POWER SUPPLY MAY RESULT IN EXTENSIVE DAMAGE WHICH IS NOT COVERED BY THE WARRANTY.

To comply with most electrical codes, the 6500 is supplied with a three-conductor AC power cable, the grounding pin of which is connected to the chassis. In some installations, this may create ground loop problems. Ground loops can result in hum and buzz if a significant potential difference exists between the AC conduit ground and the grounded metal enclosure in which the chassis is installed. If hum is experienced, one may check for the possibility of ground loops by using a two-prong to three-prong AC adapter between the power cord and the mains supply, ungrounding the AC plug temporarily. This ungrounds the Model 6500, and may cure the hum or buzz, but is not a substitute for proper system grounding. Be aware that unless the Model 6500 Two Channel Power Amplifier is AC grounded, a safety hazard can exist. UREI accepts no responsibility for legal actions or for direct, incidental or consequential damages that may result from violation of any electrical codes.

2.4 LINE VOLTAGE STRAPPING

Unless a tag on the line cord specifies otherwise, the Model 6500 was shipped ready for operation with nominal 120 VAC power mains. In order to verify or change this for nominal 100, 200, 220, or 240 V (50 Hz or 60 Hz), it will be necessary to remove the amplifier modules. The power transformers are then accessible for examination, and, if necessary, restrapping of the leads attached to the primary windings. Use the following procedure:

1. Make sure the power cord is not plugged in.
2. Remove the four screws on the front of each of the modules, and slide these modules forward and out of the mainframe.

NOTE: Both power transformers must be converted.

3. Remove the top cover of the amplifier mainframe by removing the ten screws on the top and two screws holding the cover to the front panel assembly. A large piece of insulating paper is visible between the module channel and the power transformer. This insulating paper is fastened to the front panel with a piece of Velcro and can easily be pulled away from the mainframe.

4. The piece of insulating paper is printed with connection drawings for the various strapping options and is marked to show which strapping option was utilized at the factory. Follow the appropriate connection diagram to re-strap for your line voltage. (Also refer to the schematic diagram in Section 6 if desired.)
5. Mark the insulating paper to indicate the new line voltage strapping, and replace the fish paper. Position the paper into the mainframe, between the power transformer and the module mounting rail, with the large section extending toward the rear, and secure with the Velcro fasteners. Reinstall the top cover with all twelve screws, slide the amplifier modules into the mainframe, and secure each with four module screws.
6. Change the fuse if necessary. Use a 12 amp, 3AG slo-blo fuse for 100 and 120 V connections. Use a 6 amp, 3AG slow-blow for 200, 220 and 240 V connections.

2.5 EXTERNAL CONNECTIONS

2.5.1 INPUT CONNECTIONS, GENERAL

Input signal wires should be shielded cable, and connected in accordance with standard wiring practice to either the three-conductor 6.3 mm (1/4 in) phone jacks or the XLR/QG connectors on the back of the chassis.

NOTE: The Model 6500 input connectors are wired as follows:

<u>PHONE JACK</u>	<u>XLR/QG CONNECTOR</u>	<u>MODEL 6500 CONNECTION</u>
Tip	Pin #3	"+" or HIGH
Ring	Pin #2	"Common" or LOW
Sleeve	Pin #1	to audio GROUND

For a given channel, either the XLR/QG connector or the phone jack may be used. Since both of a channel's inputs are wired in parallel, however, only one should be used at a given time (unless it is specifically desired to loop a signal through the amplifier input).

The 6500 will not unbalance floating or balanced input sources since the input circuits consist of balanced differential amplifiers. To use an unbalanced source, wire the signal carrying conductor of the cable from that source to XLR pin 3 (phone plug tip), and wire the shield to XLR pin 1 (phone plug sleeve). The unused connector terminal, pin 2 (ring), should also be connected to shield ground. Unbalanced connections are simplified by using two-conductor standard phone plugs because they automatically short the ring and sleeve together when inserted in the input jacks.

2.5.2 INPUT CONNECTIONS, MONO MODE

When operating the Model 6500 as a high powered single-channel amplifier, only the channel "A" input is used. That signal is applied "in phase" to channel "A", and, with inverted polarity, to channel "B." No signal should be applied to the channel "B" input, and the channel "B" Level control must be set to the same position as the channel "A" Level control. We recommend turning them both full on (clockwise). This assures that maximum balanced power is available from the amplifier.

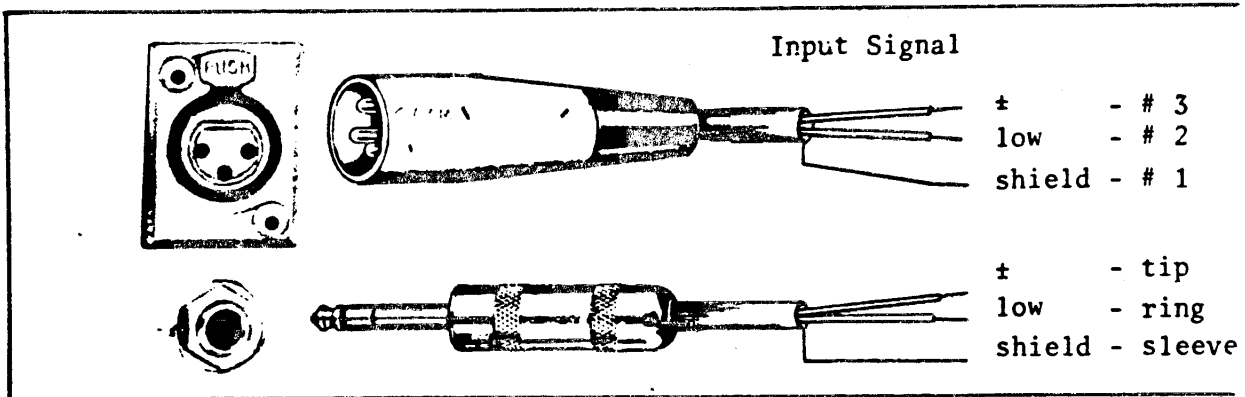

FIGURE 2-2. BALANCED INPUT CONNECTIONS*

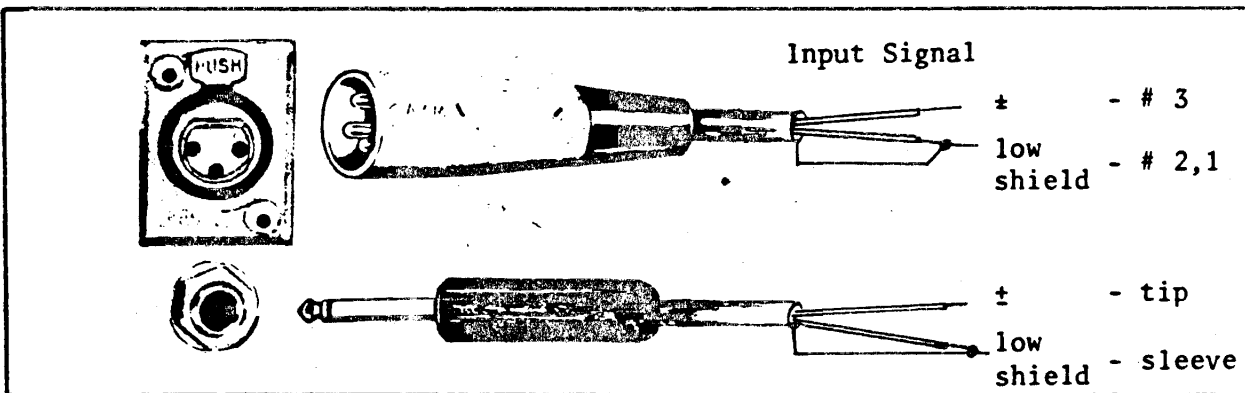

FIGURE 2-3. UNBALANCED INPUT CONNECTIONS*

* For a given channel, use either XLR/QG or phone jack, not both.
For mono operation, use only channel "A".

2.5.3 FIVE-WAY BINDING POST OUTPUTS

Five-way binding post outputs have been chosen because they allow connections to be made quickly, they facilitate polarity reversals for speaker "phasing," and they can handle high current with a greater margin of safety than phone jacks.

The preferred connection method is to use a dual banana plug for each speaker cable. Simply insert each plug into the corresponding channel's red and black binding posts.

In the absence of a dual banana plug (or two single banana plugs), there are other alternatives. To connect stranded speaker cable, loosen the plastic terminal nut, wrap the stripped and twisted wire end clockwise around the terminal, and secure it by tightening the nut.

NOTE: It is preferable to tin the wire ends with solder to prevent unraveling; avoid excess solder as it can promote cable breakage. Smaller speaker cable could be pushed through the hole in the binding post shaft, but we recommend using heavier gauge cables that ought to be wrapped around the shaft.

If a lug is installed on the cable, loosen the terminal nut, push one "leg" of the lug through the hole in the shaft, and tighten the nut.



FIGURE 2-4. USE OF FIVE-WAY BINDING POSTS.

2.5.4 ABOUT OUTPUT POLARITY AND BRIDGED MONO CONNECTION

In normal stereo operation (Fig. 2-5), a positive-going signal applied to an input's Pin #3 or the phone jack tip will cause a positive-going signal to appear at the corresponding channel's red banana jack output terminal.

In mono operation (Fig. 2-6), the two amplifier channels are driven with the same signal, but with channel "B" reversed in polarity. The speaker cable is then connected to the two channels' red binding posts (the black posts are not used in mono mode). In this case, a positive-going signal applied to the channel "A" input appears as a positive-going signal at the channel "A" red binding post.

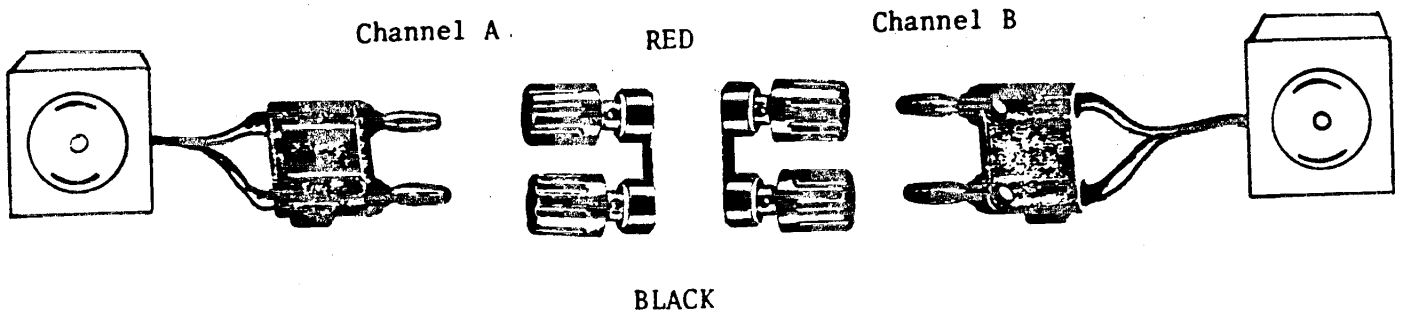

FIGURE 2-5. OUTPUT CONNECTIONS TO 2-CHANNEL SPEAKER SYSTEM.

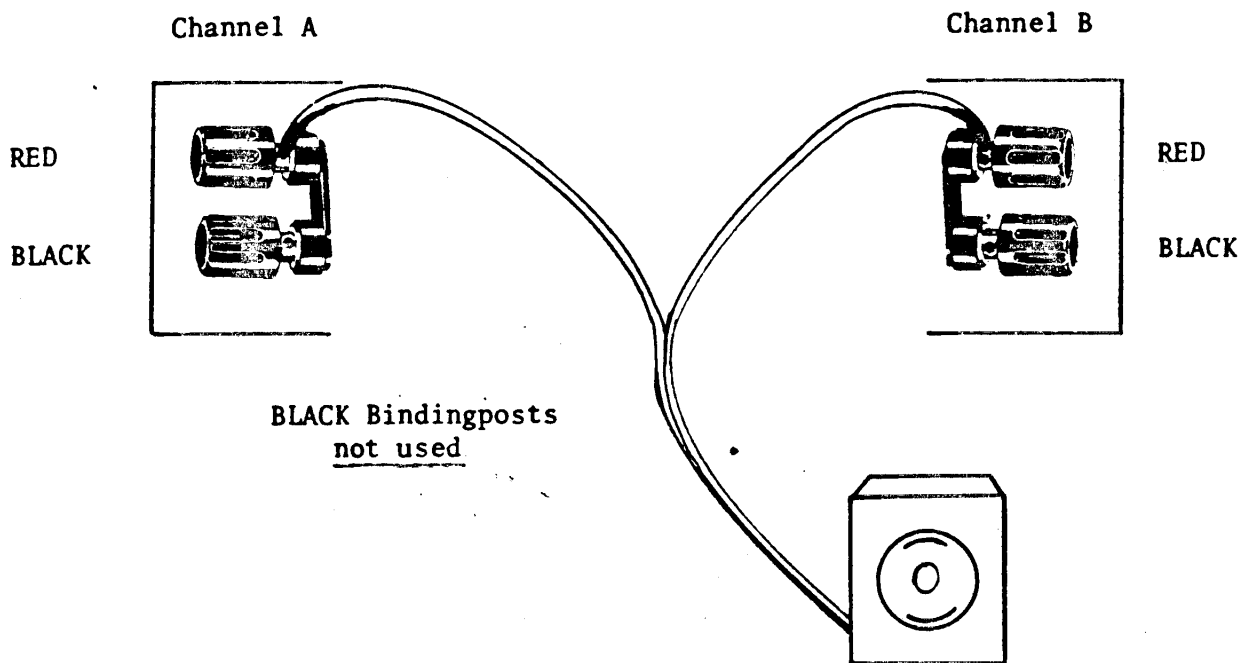

FIGURE 2-6. BRIDGED OUTPUT CONNECTIONS TO MONAURAL SPEAKER SYSTEM.

NOTE: DO NOT CONNECT THE TWO RED BINDING POSTS TO EACH OTHER, and DO NOT GROUND EITHER SIDE OF THE OUTPUT IN BRIDGED MONO MODE.

2.6 INPUT IMPEDANCE AND TERMINATION

Audio engineering had its roots in the telephone industry, and "600 ohm circuits" (together with their predecessors, "500 ohm circuits") are carry-overs from telephone transmission practices. Long audio transmission lines, like their video counterparts, must be properly sourced from and terminated in equipment which matches their characteristic impedance if optimum frequency response and noise rejection are to be achieved.

However, transmission line theory and techniques are not only unnecessary but impractical within modern recording studios, broadcast studios and other local audio systems where transmission circuits are seldom more than several hundred feet in length. The advent of negative feedback circuitry and solid-state electronics has spawned modern audio amplifiers and other signal processing devices having source impedances of only a few ohms. They are essentially indifferent to load impedances and, by varying their output current inversely to changes in load impedance, maintain the same output voltage into any load impedance above a rated minimum, with no change in frequency response.

Modern audio systems, therefore, utilize amplifiers and other active devices which have very low output impedances and high (10K to 50K) input impedances. These products may thus be cascaded (operated in series), or many inputs may be connected to a single output of a preceding device, without regard to impedance matching. Switching and patching is simplified because double loads and unterminated bugaboos are essentially eliminated. Floating (ungrounded) transformer outputs minimize ground loop problems, and differential transformerless input circuitry (or input transformers) minimize common mode noise or interference which may be induced into the interconnecting wires or cables.

Where audio must be transmitted through cables or wire pairs of more than several hundred feet in length, however, transmission line termination practices should still be observed.

The Model 6500 has input impedances of 40,000 ohms when used in a balanced, differential input configuration, and 20,000 ohms when used unbalanced (one side grounded). This makes the amplifier suitable for use with any normally encountered source impedance, low or high. Only when the 6500 is used with a source which requires a low impedance termination (such as a 600-ohm transmission line, certain passive equalizers, or older vacuum tube equipment) is a 600 ohm termination resistor required at the 6500 input.

2.7 APPROPRIATELY RATED LOADS

2.7.1 IT IS THE USER'S RESPONSIBILITY TO AVOID OVERPOWERING

It is essential that the Model 6500 be used with loudspeakers

of suitable impedance that can handle the amplifier's power output. We realize this is not always easy to determine, especially since speaker power ratings have not been standardized. Nonetheless, UREI IS NOT RESPONSIBLE FOR DAMAGE TO LOUDSPEAKERS RESULTING FROM OVERPOWERING. We do recommend protection by inserting appropriate value fuses in the speaker lines: 6 amperes for 8 ohm loads, 12 amperes for 4 ohm loads, or 20 amperes for 2 ohm loads. Bear in mind that, in some circumstances, fuses may cause signal distortion, particularly at low frequencies. (Also see Section 2.8 regarding speaker cables.)

2.7.2 MORE ABOUT LOUDSPEAKER POWER RATINGS

While there is no cut-and-dried method to establish an appropriate amplifier power for a given speaker system, certain guidelines do exist. If a loudspeaker manufacturer specifies "to be used with amplifiers rated at no more than 'x' watts," then neither speaker nor amplifier warranty is likely to cover damage if a larger amplifier is used. If the amplifier power is only recommended, or if a power rating is given without mentioning the amplifier, then the question as to whether the amplifier is "safe" becomes more difficult to answer.

Loudspeakers usually fail due to one of two factors: thermal or mechanical overload. Thermal overload means overheating, and is almost always caused by applying too high a level of sustained, average power; the voice coil insulation may burn and short circuit, the coil may deform due to the heating and scrape in the gap, and, in some cases, speaker cones have been known to burst into flame. Mechanical overload is another way of describing excessive diaphragm/voice coil travel. A single very high power transient, especially at lower frequencies, can literally tear a loudspeaker apart. Sometimes mechanical overload is more gradual, with the voice coil "bottoming" against the magnetic assembly until it is deformed; a compression driver diaphragm can strike the phase plug and shatter, or the suspension can be over extended and simply tear apart.

The frequency and waveform of a signal have a lot to do with the destructive potential of a given power output. Band limited pink noise is somewhat akin to "average program" power, although the meaning of such a rating depends heavily on crest factor (peak to average noise voltage) and specific frequency limits. Unfiltered or unweighted white noise stresses the tweeters more than the woofers. Swept sine waves may cause less thermal heating, but can cause larger excursions at low frequencies. With compression drivers, the mechanical power handling capability is approximately quadrupled simply by raising the minimum crossover frequency by an octave. If any conclusion can be drawn, it is this:

NO SINGLE POWER RATING REALLY DESCRIBES THE POWER HANDLING CAPABILITY OF ANY LOUDSPEAKER OR LOUDSPEAKER SYSTEM. ALSO, WHEN A LOUDSPEAKER SYSTEM IS MULTI-AMPLIFIED, i.e. A HIGH FREQUENCY DRIVER IS CONNECTED DIRECTLY TO THE POWER AMPLIFIER OUTPUT, A SERIES PROTECTION CAPACITOR IS STRONGLY RECOMMENDED TO REDUCE THE POSSIBILITY OF ACCIDENTAL DAMAGE TO THE DRIVER DIAPHRAGM. CONSULT THE MANUFACTURER OF THE DRIVER AND HORN FOR RECOMMENDATIONS ON PROTECTION CAPACITOR TYPES AND VALUES.

2.7.3 SOMETIMES A LARGER AMPLIFIER CAN BE SAFER

If the desired sound level is high enough that it requires a low powered amplifier to be operated at a fairly high distortion level (e.g., well into clipping), it may be safer to use a larger amplifier that will be free of distortion. It is true that in a small amp which is clipping, peak power is restricted by the size of the amplifier's power. However, the average power output rises due to the increased signal density caused by distortion components. Not only does this increase the thermal stress, it also increases mechanical stress because the squared waveforms place greater "G" loads on the moving parts, and abnormally high proportions of high frequency harmonics are generated which can fry the tweeter voice coils.

A more powerful amplifier which is able to generate the desired peak sound level without clipping avoids the large increase in average power (thermal) and the high acceleration (mechanical) stresses caused by the overdriven small amplifier. The major drawback of the larger amplifier is that it can produce higher peak outputs that may instantly destroy a loudspeaker. Therefore, great care must be exercised to ensure that the amplifier will not be driven at too high a level, certainly never at a clip. This can be accomplished either by knowing the program material (if recorded) and setting levels accordingly, or by using peak limiters (with live or unknown program material).

2.7.4 REMEMBER THE DIVIDING NETWORK (CROSSOVER)

If the amplifier is connected to a multi-way loudspeaker system that includes a passive, high-level dividing network (crossover), be sure to consider its presence. The network should be rated to handle the amplifier's power. Pre-packaged speaker system power ratings already take the crossover into account.

If you obtain separate components and assemble a system, the chances are that the higher frequency drivers will be rated at less power than the woofer(s). This works out overall because the higher frequency drivers tend to be more efficient (more sound per watt). In fact, higher sensitivity in the high frequency components usually requires some attenuation to be applied in the dividing network (remember, a 3 dB more sensitive driver must be driven with half the power to generate the same sound level).

For example, consider a typical two-way system with a 200 watt woofer and 50 watt high frequency compression driver. The woofer, 1 meter from its enclosure, generates 100 dB SPL with 1 watt at its input, and the compression driver, 1 meter from its horn, generates 106 dB SPL at 1 watt input. If both components are driven by a 200 watt program signal, the compression driver will be 6 dB too loud (four times the level of the woofer). Therefore, the crossover network must provide 6 dB of attenuation for the compression driver, lowering its input power to 50 watts. The 200 watt

amplifier turns out to be perfectly suited to driving this system, even though one driver is rated at just 50 watts.

2.8 SPEAKER CABLES

2.8.1 TYPE OF WIRE

Recently a number of companies have offered various special "speaker cables" which are claimed to vastly improve the signal delivered from amplifier to loudspeaker system. Without going into great details, suffice it to say that some special cables have merit, others may actually be detrimental, and overall the value will have to be determined by the user. In our opinion, just four factors need be considered: DC resistance, wire surface area, capacitive and inductive reactance, and durability. The first three factors combine to produce an impedance at audio frequencies, and the latter factor is important primarily in portable installations.

Generally, the larger the wire gauge, the better. DC resistance is lower with larger wire, and hence more of the amplifier power gets to the loudspeaker (and damping factor is not degraded; see Section 2.8.3). More strands of wire in a given wire gauge are beneficial because they provide a larger surface area. Since AC (audio) travels primarily along the surface (skin effect), this means the effective resistance is lower; more strands also let the cable handle more flexing without fatigue.

2.8.2 CONDUCTOR COMPENSATION

Conductor Compensation senses the effect of cables upon the signal, across the speaker terminals, and feeds this information through a second pair of wires back to the amplifier. In the amplifier, a correction signal is generated and added to the main signal with the result that the loudspeaker receives an undistorted signal, producing maximum transient response and maximum damping factor.

The Model 6500 is provided with a BNC connector on the rear of the chassis. This connector receives the information from the speaker terminals. We recommend to use a shielded cable, such as RG-58 type, thus minimizing the danger of a mixup between the "power" wires and the "sense" cable.

It is extremely important to observe correct polarity when making the connections for the conductor compensation:

The wire which connects to the inner terminal of the BNC connector must connect to that terminal at the loudspeaker which is fed from the RED binding post at the amplifier. The wire which connects to the outer terminal of the BNC connector must connect to that

terminal at the loudspeaker which is fed from the BLACK binding post at the amplifier.

If for any reason the speaker cables (the power carrying conductors) are changed over to the other channel's output, the Conductor Compensation cable must be changed over also.

NOTE: UREI "A" series Time Aligned speaker systems which were manufactured after the Model 6500 was introduced feature a BNC connector at the crossover network, greatly simplifying the utilization of the Conductor Compensation. All that is necessary is a shielded cable with BNC connectors on both ends to be connected between the amplifier and the speaker. This, of course, is in addition to the normal heavy-gauge wire required to feed the power from the amplifier to the speakers.

Conductor Compensation is also effective if the amplifier is used in the high power mono (bridged) mode. (See 2.5.4 for speaker cable wiring.) The BNC inner terminal of channel "A" connects to the loudspeaker terminal which is fed from the red output binding post of channel "A". The BNC inner terminal of channel "B" connects to the loudspeaker terminal which is fed from the red output binding post of channel "B".

It is necessary to add one final note regarding the effectiveness of Conductor Compensation. Although the user will notice a marked improvement in sound quality, it will not cause the amplifier to compensate for power losses in the speaker cable (remember Ohm's law). The maximum power that the amplifier will deliver into a load is available only at the output terminals of the amplifier. IR losses in the interconnecting wiring still translates into actual power lost to the load. Maximum power at the loudspeaker in a given installation is achieved by using the largest sized wire possible between the amp output and the speaker terminals.

2.8.3 DAMPING FACTOR

The higher the damping factor of an amplifier, the greater its ability to control unwanted speaker cone movements -- especially at low frequencies. Damping factor is easy to calculate; divide the speaker's rated load impedance by the amplifier's output source impedance. For example, an amplifier with 0.02 ohms output impedance at 1 kHz presents a damping factor of 400 to an 8 ohm speaker ($8 / 0.02 = 400$). To understand how a high damping factor improves sound quality, one must first understand the underlying principles.

When an amplifier drives a woofer, current flowing through the voice coil creates a magnetic field which interacts with the permanent magnetic field in the gap and forces the diaphragm/voice

coil assembly to move. Consider what happens when the resting cone is accelerated to a maximum velocity by a signal pulse; the maximum signal builds up, and the voice coil/diaphragm assembly tracks the current, moving outward proportionately. When the current returns to zero, the suspension and the air mass loading the diaphragm pull it back toward its original resting position, and momentum tends to cause overshoot past that point.

In the absence of an applied signal, the voice coil is moving through a magnetic field, and according to basic physical laws it generates a current opposite to that of the original driving signal. This current induces a voltage or "back EMF" at the amplifier's output terminals.

The back EMF travels through the amplifier's output source impedance to ground. The lower that impedance, the better the "braking" action on the voice coil; a direct short across the coil (zero ohms) would allow minimal overshoot. Low impedance equals high damping factor, so the benefits of high damping factor become obvious -- tighter control of the loudspeaker.

The theoretical damping factor of an amplifier may not be realized at the speaker because speaker cables always have a finite resistance or impedance; the back EMF must also travel through the cable, so the damping becomes less. Hence, larger gauge cables not only reduce signal losses, they improve performance by affecting damping factor less than smaller gauge cables.

2.8.4 CALCULATING LOSSES IN SPEAKER CABLE

The chart in Figure 2-7 may be consulted to establish the approximate power loss (and damping factor degradation) for various wire gauges. The chart assumes stranded cable, but since skin effect and reactive effects will vary, these numbers can only be considered as rough guides.

WIRE DIAM. (mm)	A.W.G. WIRE GAUGE	DC RESISTANCE PER 30 m (100 ft) OF TWO-CONDUCTOR CABLE (OHMS)	CABLE LENGTH WHICH WILL PRODUCE A ONE dB POWER LOSS (21% LESS POWER TO SPEAKER)			
			•@ FOUR ohms		@ EIGHT ohms	
			meters	feet	meters	feet
4.115	6	0.08	366	1200	740	2425
3.264	8	0.13	244	800	488	1600
2.588	10	0.20	145	475	290	950
2.05	12	0.32	91	300	183	600
1.63	14	0.52	58	190	114	375
1.29	16	0.82	37	120	73	240
1.02	18	1.32	23	75	46	150
0.813	20	2.08	15	50	30	100
0.643	22	3.30	9	30	18	60

FIGURE 2-7. POWER LOSSES IN SPEAKER CABLES

SECTION III
OPERATING INSTRUCTIONS

3.1 GENERAL

The 6500 Power Amplifier should be installed and connected to both the signal source and the loudspeaker system according to Section II. Set the Level controls to minimum. Then, after the preceding equipment is turned on to provide a stable input signal, the power amplifier may be turned on.

NOTE: IT IS CONSIDERED A SAFE OPERATING PRACTICE ALWAYS TO TURN THE POWER AMPLIFIER ON LAST, AND TURN IT OFF FIRST. THIS PREVENTS ANY POSSIBLE TURN-ON/TURN-OFF TRANSIENTS OR EXCESS LEVELS THAT MIGHT BE GENERATED IN THE LINE LEVEL SIGNAL PROCESSING EQUIPMENT FROM REACHING THE LOUDSPEAKERS.

3.2 TURN ON AND SYSTEM CHECK

Apply program material, and be ready to monitor the speaker output. Turn on the POWER switch, and observe the indicator LEDs. Initially, the STANDBY LEDs may turn on for a few seconds. While the SIGNAL LEDs should be illuminated, no sound will be audible (regardless of Level control setting) because the protection relays have not yet connected the output stage to the five-way binding posts.

After a few seconds, the relays will actuate as the STANDBY LEDs turn off and the NORMAL LEDs turn on. At this point, bring up the Level controls until a suitable listening level is reached.

3.2.1 A NOTE ON AMPLIFIER COOLING

Although the need for adequate cooling of the amplifier was briefly discussed under Section II, 2.2, it is necessary to describe the cooling system in more detail.

The amplifier will get hot when operated over a period of time at high output levels. Under normal conditions, the amplifier does not overheat.

The built-in fans are servo-controlled and operate at a speed proportional to the amount of heat sink cooling required. Initially, the fans should turn at a low speed. Speed may increase as the amplifier operates for a prolonged period at output levels which cause the unit to dissipate more heat. However, if a fault exists or if the ventilation is not sufficient, the temperature may rise to a point which could cause damage to individual components. The protection circuit then opens the output relays until safe operating temperature is reestablished. If such thermal cycling should occur, and the fans operate properly, check whether cooling air flow to the amplifier is insufficient or the heated air cannot be vented away from the amplifier. Also, check the foam filters on the front of the amplifier which may be blocked by dust particles. Occasional cleaning with soap and water is necessary.

3.3 CLIP AND SIGNAL PRESENT INDICATORS

3.3.1 CLIPPING INDICATORS

The Model 6500 differential input amplifiers are of sufficient sensitivity to be driven to full output by any medium or high line level source; an input of +3 dB (1.1 V rms) will produce maximum rated output into 8 ohms. Due to an attenuator (the Level control) which comes after the input stage, signal levels up to a maximum of +20 dB (7.75 Vrms) can be accommodated without driving the input or output stages to clipping.

The channel's front panel CLIP LED will turn on whenever signals exceed the clipping level at the output stage, enabling the operator to take appropriate action. This LED will remain on long enough to be seen even if the excess signal is only a brief transient. To avoid audible distortion, when the LED indicator flashes more than occasionally, either lower the level of the source feeding the amplifier or turn down the amplifier's Level control.

Overload conditions are monitored separately for each channel. However, they are not monitored in the input differential amplifiers. Since a +3 dB signal is adequate to drive the amplifier to full output and the input stages will handle up to +20 dB without clipping, there is little likelihood of clipping in this stage; it is only possible when the amplifier's Level control is set at #2 or lower. The symptom of such input overdrive is audible distortion without any indication from the CLIP LED. In such cases, simply lower the signal level at the source and use a higher number on the amplifier Level control.

3.3.2 ABOUT SENSITIVITY RATINGS

With regard to sensitivity ratings, power amplifiers are unique. Other audio signal processing and mixing equipment sensitivity describes the average input/output level, whereas a power amplifier's sensitivity describes the input signal required to obtain maximum power output. Therefore, if a mixer, equalizer, or other device is rated at +4 dB nominal output, that average level could continuously overdrive the power amplifier. This is why a level control is provided on the amplifier. By turning down the level at the amplifier, input sensitivity is effectively reduced to match the source so that only peaks drive the amplifier to full output. With a mixer, equalizer, etc. rated at -10 dB to -15 dB nominal output, little or no attenuation is required in the power amplifier.

3.3.3 SIGNAL PRESENT INDICATORS

Sensors in each input stage turn on the SIGNAL LED when an input signal is present at or above -5 dB in level.

NOTE: If no output at all is audible when the amplifier level is turned up, the SIGNAL LED is on, and the NORMAL LED is on, look for a broken or disconnected cable or a failed loudspeaker. A short circuit, too low an impedance due to paralleled speakers, or an overheated amplifier will cause the STANDBY LED to turn on; if NORMAL and SIGNAL LEDS are on and the cable/speaker system checks out, the amplifier may have failed.

3.4 MONO OPERATION

When operating the Model 6500 as a monaural power amplifier (bridged output), the rear panel Stereo-Mono switch must be in Mono position, and the speaker system must be wired as shown in Figure 2-6. No signal should be applied to the channel "B" input, and the channel "B" Level control must be set to the same position as the channel "A" Level control. If the amplifier is operating normally, the channel "A" and "B" indicator LEDs will function identically.

SECTION IV
THEORY OF OPERATION

NOTE: In the following descriptions, the component designation for Channel A is used. Additional information regarding Channel B is contained in the schematic diagram in Section VI.

4.1 INPUT AMPLIFIER

A low noise IC, IC1-A and IC1-B, is configured as a differential input amplifier of unity gain (max input +20 dB). It thereby accepts a balanced or unbalanced input source.

An attenuator type level control follows the input amp, providing unity gain to full attenuation. The mid point of control rotation corresponds to 6 dB of attenuation.

4.2 SIGNAL INDICATOR

IC2-B is an integrating rectifier with a gain of 20. Whenever a signal over -5 dB is present at the input to the level control, the rectifier turns on LED DS4, the SIGNAL indicator.

4.3 SUMMING AMPLIFIER

The summing amplifier, IC1-D, has a gain of 10. It combines a filtered signal from the input level control with frequency compensated negative feedback from the power amplifier output. IC1-D's output drives the forward gain section of the amplifier. The nominal amount of the feedback is 1/40 (-32 dB).

4.4 VOLTAGE AMPLIFIER

The voltage amp consists of Q1 through Q7, and is driven by the summing amplifier output. The stage has a gain of 50, set by local negative feedback, keeping THD low and optimizing linearity.

Q7 is controlled by R36, a trimmer control on the circuit board, and sets the bias of the output stage for Class AB operation.

4.5 CURRENT AMPLIFIER

Comprised of Q11, Q12, and Q15 through Q26, this section has an overall voltage gain of 1. Q11 and Q12 provide the initial current gain necessary to drive the main output transistors from the voltage amplifier's output. Output transistors Q15 through Q26 then provide the high current gain necessary to drive rated loads.

4.6 OUTPUT PROTECTION

Transistors Q13 and Q14 sense output current in the load, examining 2 time duration ranges matched to the safe operating area (SOA) of the output devices. If the SOA is exceeded, signal to the pre-drivers (Q11 and Q12) is reduced.

Transistors Q27 and Q28 sense overcurrent in the voltage amplifier stage; if overload occurs they protect the voltage amplifiers.

4.7 CLIP INDICATOR

Comprised of IC2-A and CLIP indicator DS1, this stage senses the summing amplifier output. LED DS1 is turned On when the feedback loop goes non-linear. The LED current is subject to a time constant so that short duration non-linearities will be visible to the operator.

4.8 RELAY CIRCUIT

Normally the relay K1 is closed and completes the signal path from the output of the power amplifier to the output binding posts. If IC2-C senses a dc voltage at the amplifier output, or the thermistor R52 measures a temperature in excess of +85°C at the heat sink, the base drive to Q8 is turned off, and the relay opens. Simultaneously the opto-isolator IC3 is turned on, driving the fan to full speed. The relay amplifier also supplies the current to turn on the green NORMAL LED, DS3, or the red STANDBY LED, DS2.

4.9 FAN CIRCUIT

The speed of each amplifier module's cooling fan is continuously variable. Sensors detect the heat sink temperature. Opto-isolator IC3 and/or thermistor R59 provide the drive to the high gain darlington configuration Q9 and Q10, gating current through the rectifier diodes CR17 to CR20, and also through the winding of the fan. The two channels operate independently.

4.10 POWER SUPPLY

Each amplifier module has a completely separate power supply in the mainframe of the amplifier. Although dimensioned very conservatively to provide sufficient reserve power, the design is conventional. High voltage of ±80 VDC constitutes the "rails" of the output stage, while a lower supply voltage of ±15 V for the op-amp circuitry is generated and regulated through zener diodes CR12, CR23 and transistors Q1 and Q2. The transformer primary is fused, and is strappable for various AC line voltages (refer to Section 2.4).

4.11 CONDUCTOR COMPENSATION

IC1-C and associated components comprise the circuitry which achieves the Conductor Compensation. Voltage sensed remotely (at the loudspeaker) is used to generate a correction signal that is introduced into the main feedback path at the summing amplifier IC1-D.

SECTION V MAINTENANCE

5.1 GENERAL

The Model 6500 is an all solid-state unit, ruggedly constructed with only the highest quality components. As such, it should provide years of trouble free use with normal care. All parts used are conservatively rated for their application, and workmanship meets the rigid standards you have learned to expect in UREI products.

EXCEPT FOR PERIODIC CLEANING OF THE AIR FILTERS,
NO SPECIAL PREVENTIVE MAINTENANCE IS REQUIRED.

5.2 REPAIRS AND WARRANTY

This product is factory warranted to the original purchaser against defects in material and workmanship for one year after initial purchase. This limited warranty must be activated at the time of purchase by returning the registry portion of the Warranty Card to the factory. Should a malfunction ever occur, the dealer from whom the unit was purchased will be glad to handle return for factory repair. Please call or write to the factory for a Return Authorization Number which must accompany all repairs. For prompt service, ship the unit prepaid directly to the factory with the RA Number visible on the shipping label. Use the original factory carton; if necessary, call the factory to secure a new carton at a nominal charge. The amplifier is heavy, and shipping to the factory is at the customer's risk; do not take a chance with inadequate packing materials. Tape a note to the top of the unit describing the malfunction, and instructions for return. We will pay one-way return shipping costs on any in-warranty repair.

Because of specially selected components in this product, field repairs, with the exception of swapping modules, are not authorized during the warranty period, and attempts to perform repairs may invalidate the warranty.

Even if your unit is out of warranty, we recommend that you return it to the factory for repairs. Our experienced personnel, supported by special test equipment, will be able to find and eliminate any problem in the most efficient way.

WARNING: The full AC line voltage is present at several points inside the chassis. Be careful to avoid personal shock if you remove the covers.

5.3 AIR FILTERS

Over a period of time the foam filters will collect dust and inhibit air flow. Periodically, remove the filters and wash them in soapy water. Rinse thoroughly in clean water, and allow them to dry before reinstalling them in the amplifier.

SECTION VI
SCHEMATIC DIAGRAM

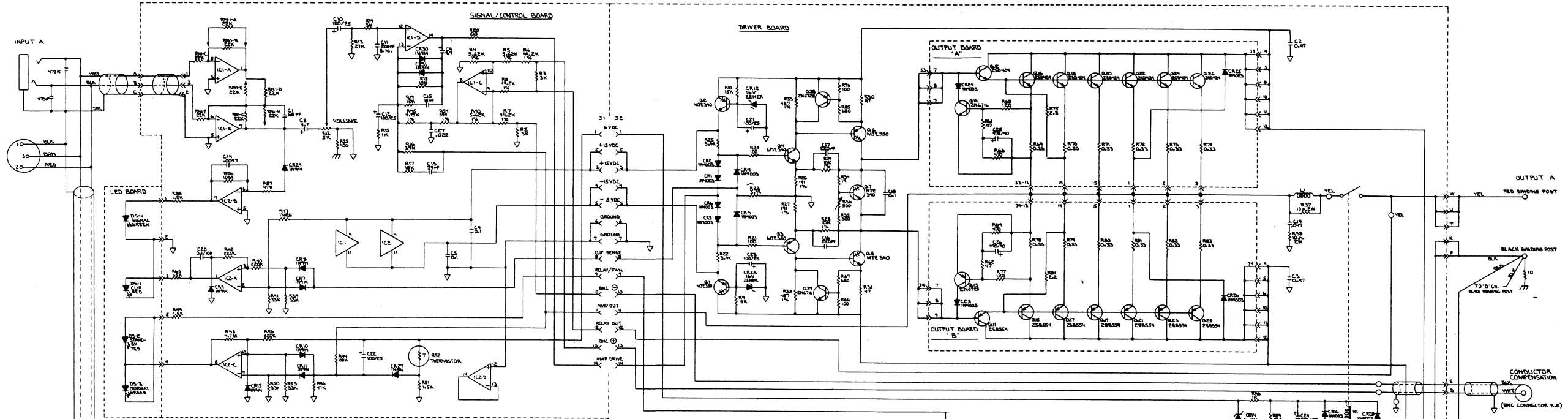

CONDUCTOR COMPENSATION WIRING

POSITIVE TERMINAL (INNER PIN OF B.N.C. CONNECTOR) OF CONDUCTOR COMPENSATION CONNECTS TO POSITIVE OUTPUT OF AMPLIFIER AT LOUSPEAKER TERMINAL.
 NEGATIVE TERMINAL (OUTER RING OF B.N.C. CONNECTOR) OF CONDUCTOR COMPENSATION CONNECTS TO NEGATIVE OUTPUT OF AMPLIFIER AT LOUD SPEAKER TERMINAL.
 FOR MONO (BRIDGE) CONNECTION INNER PIN OF CH. A B.N.C. CONNECTS TO AMPLIFIER OUTPUT A AT SPEAKER TERMINAL AND INNER PIN OF CH. B B.N.C. CONNECTS TO AMPLIFIER OUTPUT B AT SPEAKER TERMINAL.
 CONSULT MANUAL FOR DETAILS.

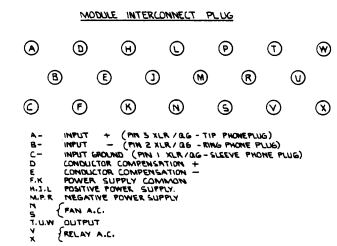
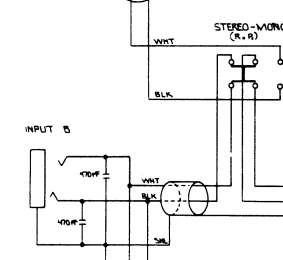

CHANNEL A SHOWN. CHANNEL B IDENTICAL WITH EXCEPTION OF INPUT DETAIL SHOWN.

POWER TRANSFORMER SHOWN CONNECTED FOR NOMINAL 120V AC LINE. ALTERNATE CONNECTIONS SHOWN FOR 100, 200, 220, 240 V AC MAINS. INSTRUCTIONS IN MANUAL AND INSIDE MAINFRAME DETAIL PROCEDURE FOR CHANGING STRAPPING.

REAR PANEL FUSE IS 12A 3AG FOR 100, 120V CONNECTIONS. CHANGE TO 6A 3AG FOR 200, 220, 240V CONNECTIONS.

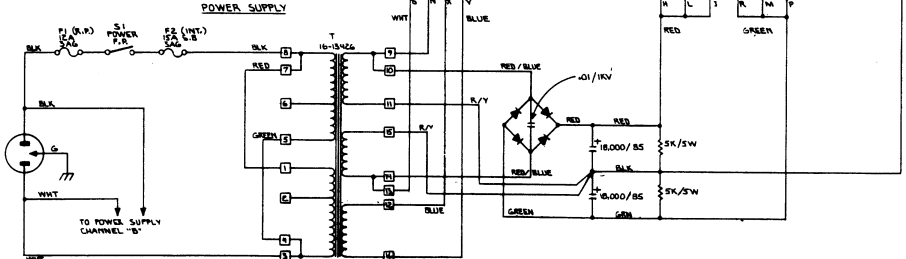
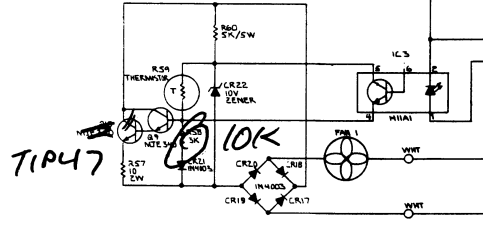
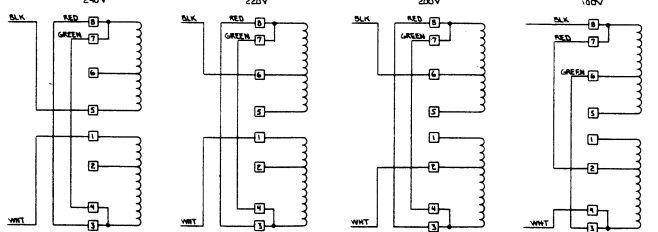

7, 8, P INDICATES COMPONENT LOCATED ON REAR PANEL
 4, 5, 6 INDICATES MODULE TO MAINFRAME INTERCONNECT PIN.
 5, 7 INDICATES COMMON GROUND.
 4, 7 INDICATES CIRCUIT GROUND.
 2, 3 INDICATES WIRE CONNECTION TO P.C. BOARD.
 E. CAPACITOR VALUES ARE IN MICROFARADS.
 F. RESISTOR VALUES ARE IN OHMS 2.5% 1/2W
 UNLESS OTHERWISE SPECIFIED.

SCHEMATIC		
FIG. NO.	MODEL	REVISION NO.
D	6500	15523
DATE 2-2-78 BY: S.P. 10/10/78		