

SERVICE MANUAL

MODEL:TR-1 (DM & EX)

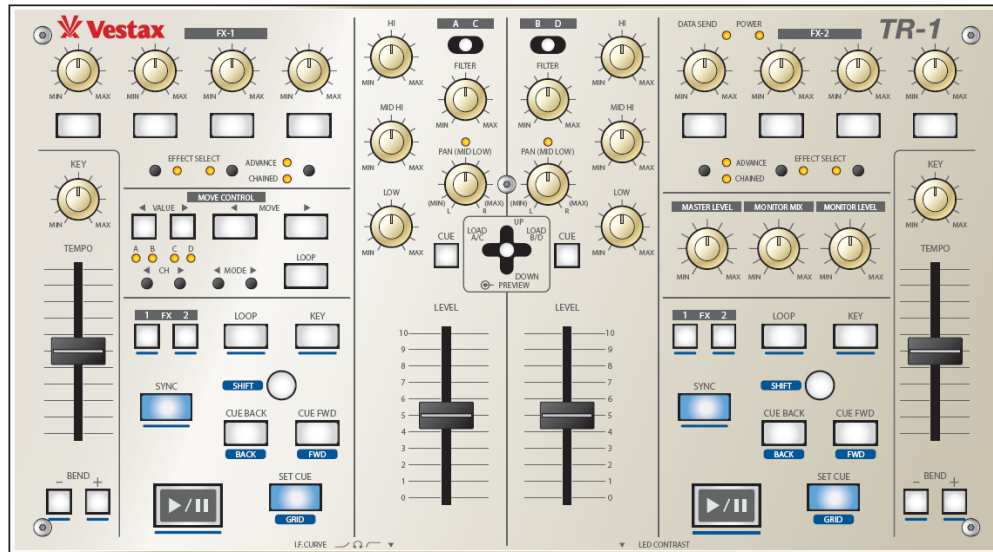

SPECIFICATION

Features:

- > Selectable deck control (Max 4 channels)
- > Can control up to more than 160 parameters of compatible software
- > New SHIFT switch feature to customize deck control functions
- > Smooth 60mm slide input faders for high-precision mixing
- > module divided system compatible with any DJ style

MINIMUM SYSTEM REQUIREMENTS (Operating System)

Windows

- Windows XP (SP2, 32Bit) or Window Vista (SP1, 32Bit, 64Bit)
- CPU: Pentium 4 or Athlon 1.4GHz(SSE1) or better
- RAM : 1GB or better

Macintosh

- Mac OS X 10.4 or higher
- CPU: Intel Core™ Duo 1.66GHz or better
- RAM: 1GB or better

POWER SUPPLY • OTHERS

POWER ADAPTOR :	DC 9V 500mA (option)
VOLTAGE :	5V (USB POWER)
POWER CONSUMPTION :	300mA
DIMENSIONS :	359(D) x 198(D) x 35(H)[45(H) with knobs]
WEIGHT :	2.6 Kg

TR-1 TEST PROCEDURE (LED)

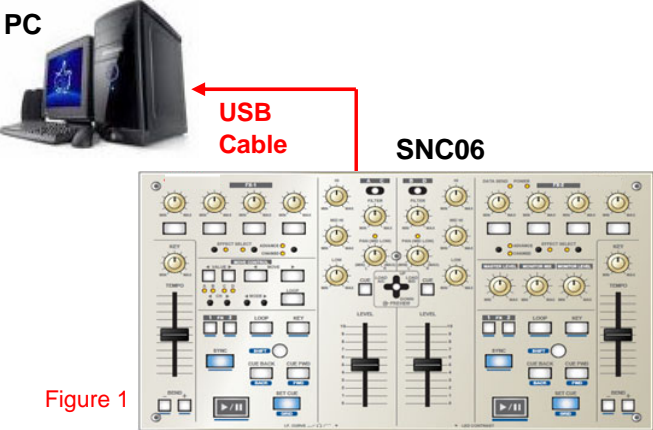
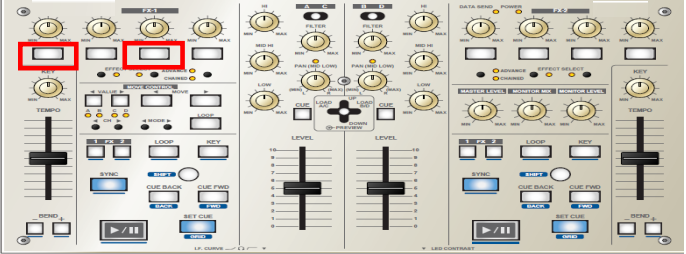
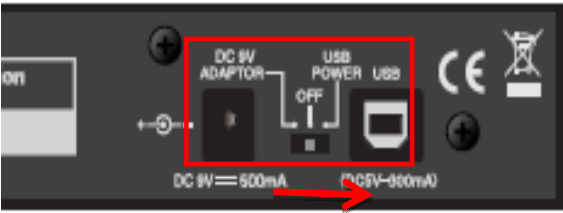
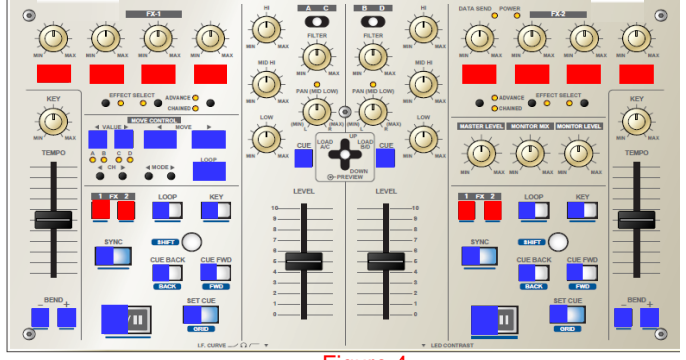
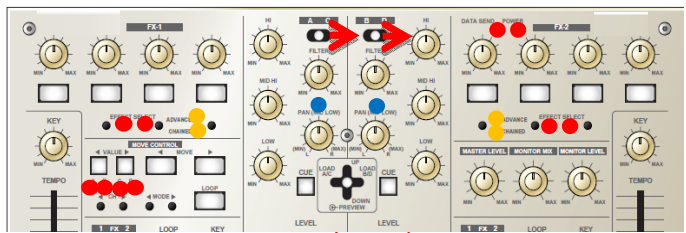
No.	Description	Example
1	Please prepare equipment as below: i. USB cable X 1 pcs ii. PC (with Midi-OX) X 1 pcs iii. SNC06 X 1 set	
2	Connect the equipment according to the figure 1	 <p style="text-align: center;">Figure 1</p>
3	<p><u>LED Test</u></p> <p>1. Press the 2 button as high lighted on the figure 2. After turn on the power by switch to USB like Figure 3.</p> <p>2. While pressing the button, both button that pressing will become red. After release the button. The both side button such as L</p>	 <p style="text-align: right;">Figure 2</p>  <p style="text-align: right;">Figure 3</p>  <p style="text-align: center;">Figure 4</p>  <p style="text-align: center;">Figure 5</p>

TR-1 TEST PROCEDURE (VR)

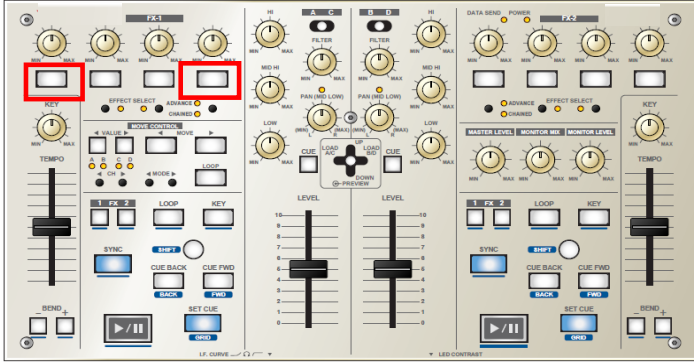
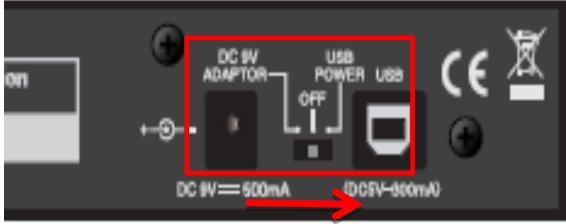
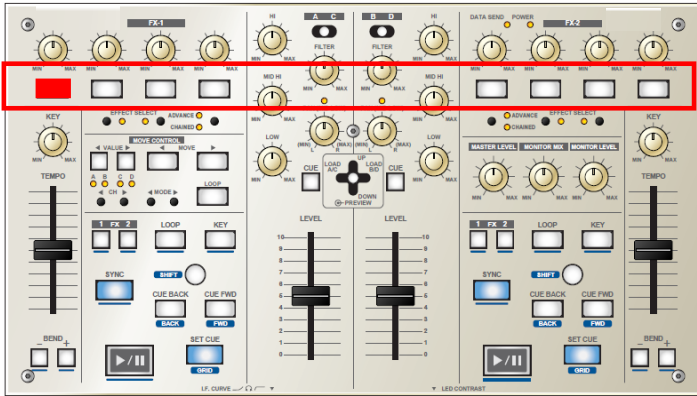
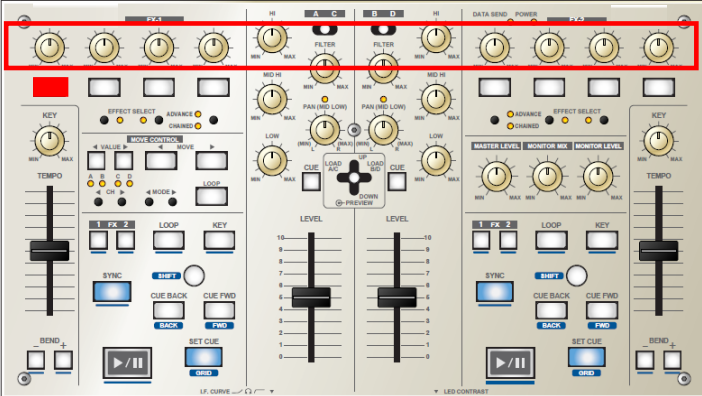
No.	Description	Example
1	<p>VR Test</p> <p>Press the 2 button as high ligthed on the figure 6. After turn on the power by switch to USB like Figure 7.</p>	 <p style="text-align: center;">Figure 6</p>
2	<p>While pressing the button, both button that pressing will become red. After release the button. All button LED will OFF</p>	 <p style="text-align: center;">Figure 7</p>
3	<p>Aftat that turn the FX1 VR1 to min, the FX-1 Button A will light ON. Turn the VR1 slowly to Maximum, FX1 Button B, Button C, Button D, FX2 Button A, Button B, Button C, and Button D will lights ON and OFF one by one untill the VR turn to MAX the lights w</p>	 <p style="text-align: center;">Figure 8</p>
4	<p>Same As above, Please Move the Fader. LED movement same as above.</p>	 <p style="text-align: center;">Figure 9</p>

TR-1 TEST PROCEDURE (VR)

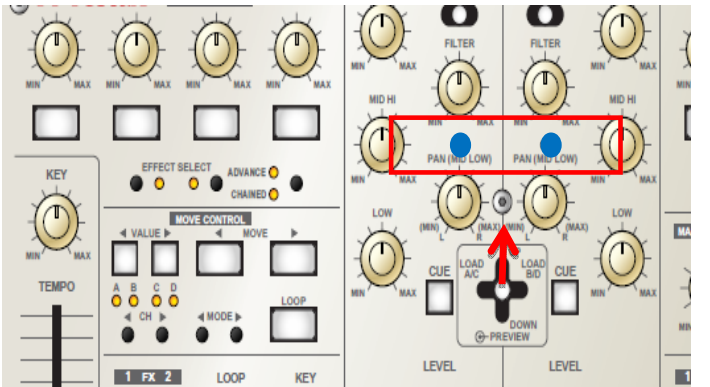
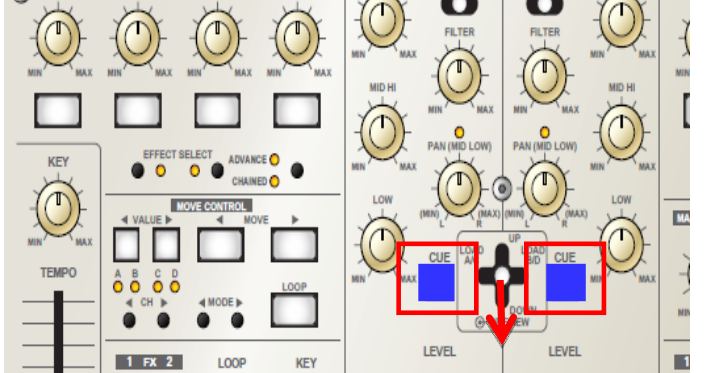
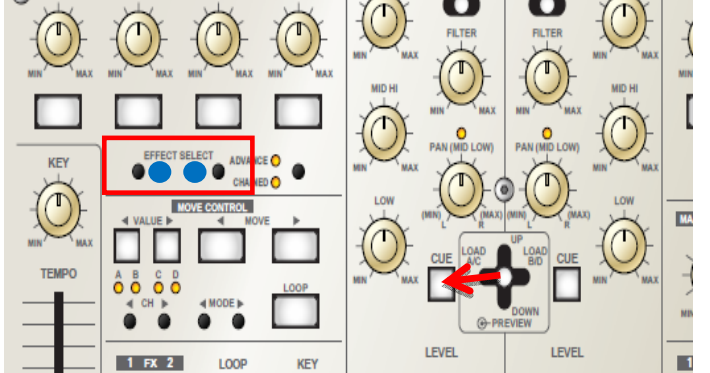
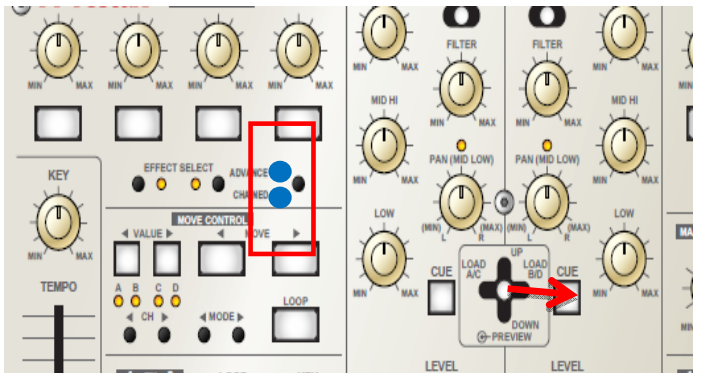
No.	Description	Example
5	Move the (Figure 10) switch to UP. The above Pan LED will lights ON	 <p style="text-align: center;">Figure 10</p>
6	Move the (Figure 11) switch to DOWN. The CUE LED will lights ON	 <p style="text-align: center;">Figure 11</p>
7	Move the (Figure 12) switch to LEFT. The EFFECT & SELECT LED will lights ON	 <p style="text-align: center;">Figure 12</p>
8	Move the (Figure 13) switch to RIGHT. The ADVANCE & CHAINED LED will lights ON	 <p style="text-align: center;">Figure 13</p>

TR-1 TEST PROCEDURE (USB)

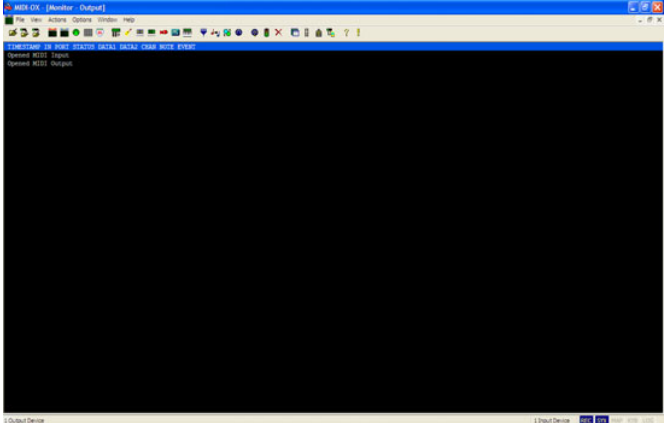
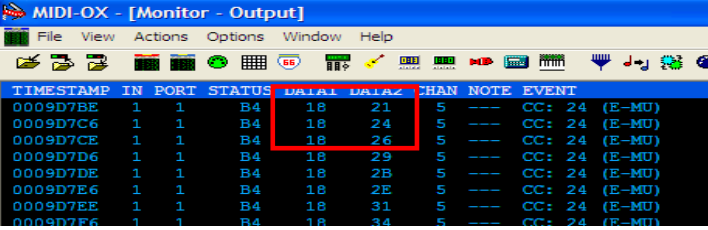
No.	Description	Example																																																																																	
1	<p><u>USB Test</u></p> <p>Power On the set and click on the MIDI-OX programme.</p>																																																																																		
2	<p>The software will prompt out.</p>																																																																																		
3	<p>Start to turn the VR, VR from Min Data2 from Screen will show 00 turn to Max will turn to 7F. Beside that each of the VR have their own identity at Data 1. Each of the VR and button identity will shown at Figure 17.</p> <ol style="list-style-type: none"> 1. FX1 VR1 : Data 1 = 18 ; Data 2 = 00~7F 2. FX1 VR2 : Data 1 = 19 ; Data 2 = 00~7F 3. FX1 VR3 : Data 1 = 1A ; Data 2 = 00~7F 4. FX1 VR4 : Data 1 = 1B ; Data 2 = 00~7F 5. FX1 Button1 : Data 1 = 3C ; Data 2 = 00~7F 6. FX1 Button2 : Data 1 = 3D ; Data 2 = 0 	 <table border="1" data-bbox="786 863 1490 1010"> <thead> <tr> <th>TIMESTAMP</th> <th>IN</th> <th>PORT</th> <th>STATUS</th> <th>DATA1</th> <th>DATA2</th> <th>CHAN</th> <th>NOTE</th> <th>EVENT</th> </tr> </thead> <tbody> <tr> <td>0009D7BE</td> <td>1</td> <td>1</td> <td>B4</td> <td>18</td> <td>21</td> <td>5</td> <td>---</td> <td>CC: 24 (E-MU)</td> </tr> <tr> <td>0009D7C6</td> <td>1</td> <td>1</td> <td>B4</td> <td>18</td> <td>24</td> <td>5</td> <td>---</td> <td>CC: 24 (E-MU)</td> </tr> <tr> <td>0009D7CE</td> <td>1</td> <td>1</td> <td>B4</td> <td>18</td> <td>26</td> <td>5</td> <td>---</td> <td>CC: 24 (E-MU)</td> </tr> <tr> <td>0009D7D6</td> <td>1</td> <td>1</td> <td>B4</td> <td>18</td> <td>29</td> <td>5</td> <td>---</td> <td>CC: 24 (E-MU)</td> </tr> <tr> <td>0009D7DE</td> <td>1</td> <td>1</td> <td>B4</td> <td>18</td> <td>2B</td> <td>5</td> <td>---</td> <td>CC: 24 (E-MU)</td> </tr> <tr> <td>0009D7E6</td> <td>1</td> <td>1</td> <td>B4</td> <td>18</td> <td>2E</td> <td>5</td> <td>---</td> <td>CC: 24 (E-MU)</td> </tr> <tr> <td>0009D7EE</td> <td>1</td> <td>1</td> <td>B4</td> <td>18</td> <td>31</td> <td>5</td> <td>---</td> <td>CC: 24 (E-MU)</td> </tr> <tr> <td>0009D7F6</td> <td>1</td> <td>1</td> <td>B4</td> <td>18</td> <td>34</td> <td>5</td> <td>---</td> <td>CC: 24 (E-MU)</td> </tr> </tbody> </table>	TIMESTAMP	IN	PORT	STATUS	DATA1	DATA2	CHAN	NOTE	EVENT	0009D7BE	1	1	B4	18	21	5	---	CC: 24 (E-MU)	0009D7C6	1	1	B4	18	24	5	---	CC: 24 (E-MU)	0009D7CE	1	1	B4	18	26	5	---	CC: 24 (E-MU)	0009D7D6	1	1	B4	18	29	5	---	CC: 24 (E-MU)	0009D7DE	1	1	B4	18	2B	5	---	CC: 24 (E-MU)	0009D7E6	1	1	B4	18	2E	5	---	CC: 24 (E-MU)	0009D7EE	1	1	B4	18	31	5	---	CC: 24 (E-MU)	0009D7F6	1	1	B4	18	34	5	---	CC: 24 (E-MU)
TIMESTAMP	IN	PORT	STATUS	DATA1	DATA2	CHAN	NOTE	EVENT																																																																											
0009D7BE	1	1	B4	18	21	5	---	CC: 24 (E-MU)																																																																											
0009D7C6	1	1	B4	18	24	5	---	CC: 24 (E-MU)																																																																											
0009D7CE	1	1	B4	18	26	5	---	CC: 24 (E-MU)																																																																											
0009D7D6	1	1	B4	18	29	5	---	CC: 24 (E-MU)																																																																											
0009D7DE	1	1	B4	18	2B	5	---	CC: 24 (E-MU)																																																																											
0009D7E6	1	1	B4	18	2E	5	---	CC: 24 (E-MU)																																																																											
0009D7EE	1	1	B4	18	31	5	---	CC: 24 (E-MU)																																																																											
0009D7F6	1	1	B4	18	34	5	---	CC: 24 (E-MU)																																																																											

DISASSEMBLY PROCEDURES

1. REMOVAL OF FACE PLATE AND SUPPORT PLATE ASS'Y (Fig. 1)

- (a) Remove all of rotate knobs (23pcs) from face plate
- (b) Remove 4pcs of slide knobs from face plate
- (c) Remove 2pcs of push switch knob and a stick knob from face plate
- (d) Remove 5pcs of screws from face plate

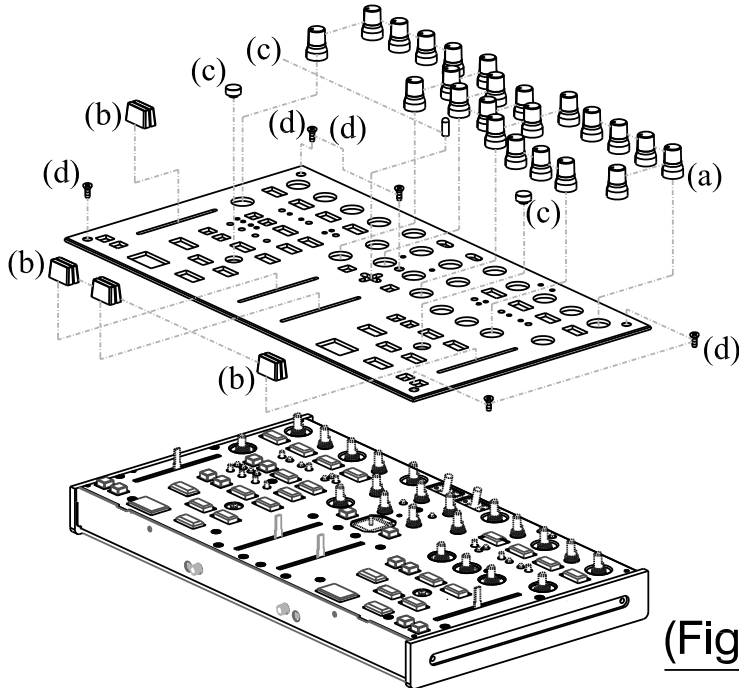

(Fig. 1)

2. REMOVAL OF BOTTOM CHASSIS, SIDE PANEL AND IF CURVE PCB (Fig. 2)

- (a) Remove 4pcs of screws from both side panel
- (b) Remove a connector wire from if curve pcb
- (c) Remove 5pcs of screws from bottom chassis
- (d) Remove 2pcs of screws from support plate ass'y

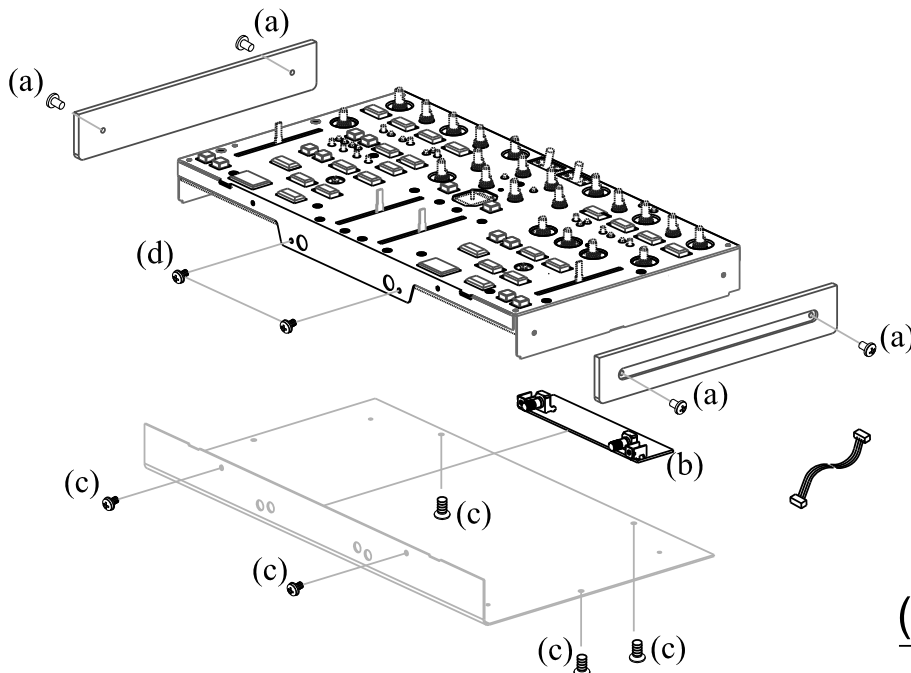

(Fig. 2)

DISASSEMBLY PROCEDURES

3. REMOVAL OF REAR PANEL AND CPU PCB (Fig. 3)

- (a) Remove all of screws (8pcs) from rear panel
- (b) Remove 3pcs of connector wire from cpu pcb

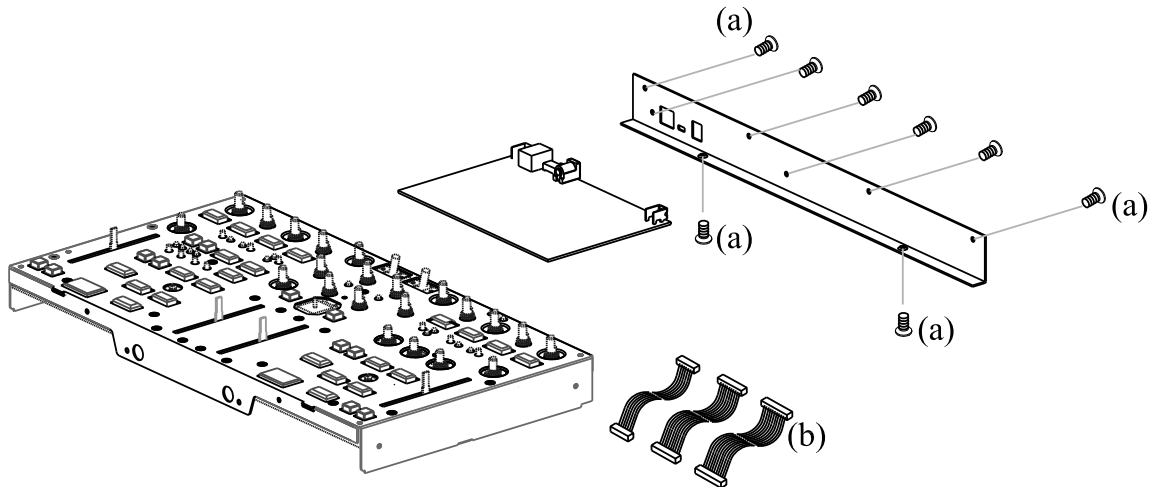

(Fig. 3)

4. REMOVAL OF PANEL PCB, A IF PCB AND B IF PCB (Fig. 4)

- (a) Remove 8pcs of screws from A if pcb and B if pcb.
- (b) Remove 2pcs of connector wires from A if pcb and B if pcb.
- (c) Remove 11pcs of screws from panel pcb

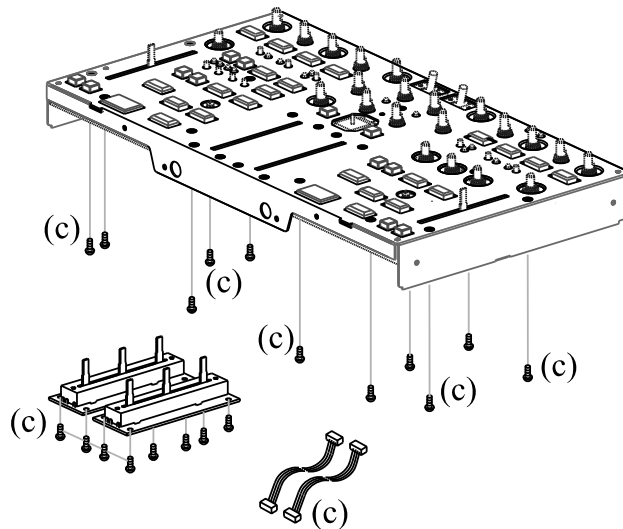

(Fig. 2)

DISASSEMBLY PROCEDURES

1. REMOVAL OF TOP COVER AND BOTTOM BOARD (Fig. 1)

- (a) Open the Top Cover by pressing the plastic fix plate (hinge)
- (b) Remove all of screws (8 pcs) from Bottom Board

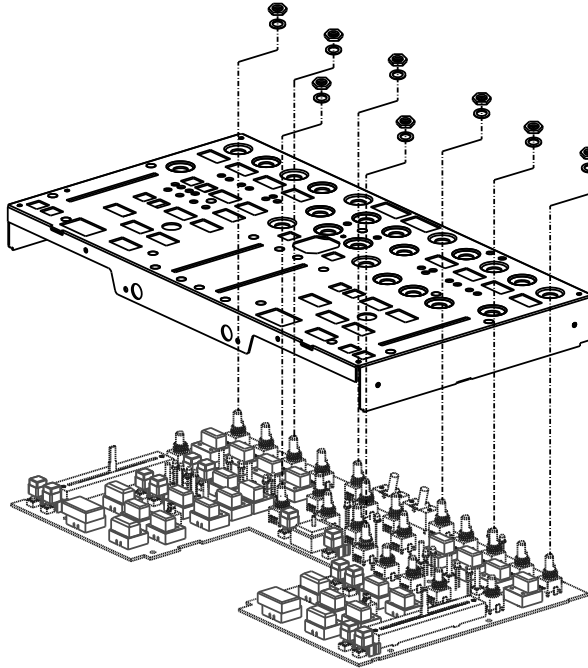

(Fig. 1)

2. REMOVAL OF MOTOR (Fig. 2)

- (a) Remove a e ring, platter, belt, center shaft, 4pcs of washers, nut and lug from cabinet
- (a) Remove a motor cover, 3pcs of screws and cushion motor, motor from cabinet..

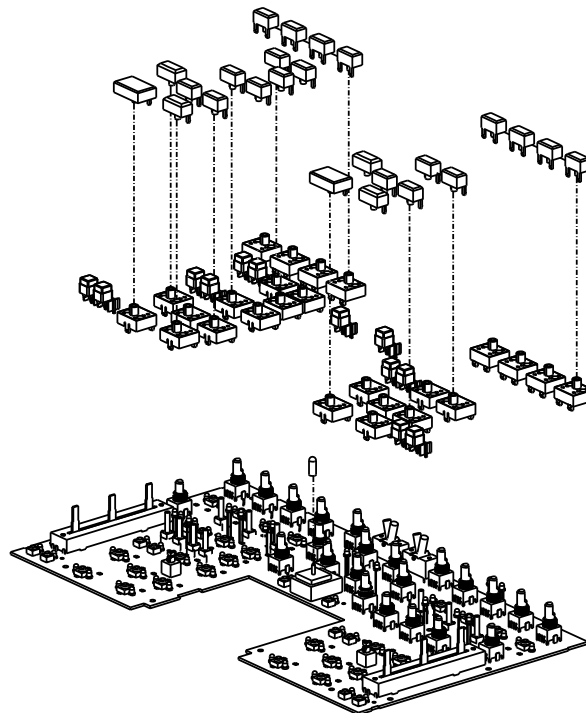

(Fig. 2)

WIRING DIAGRAM

MODEL: TR-1(DM & EX)

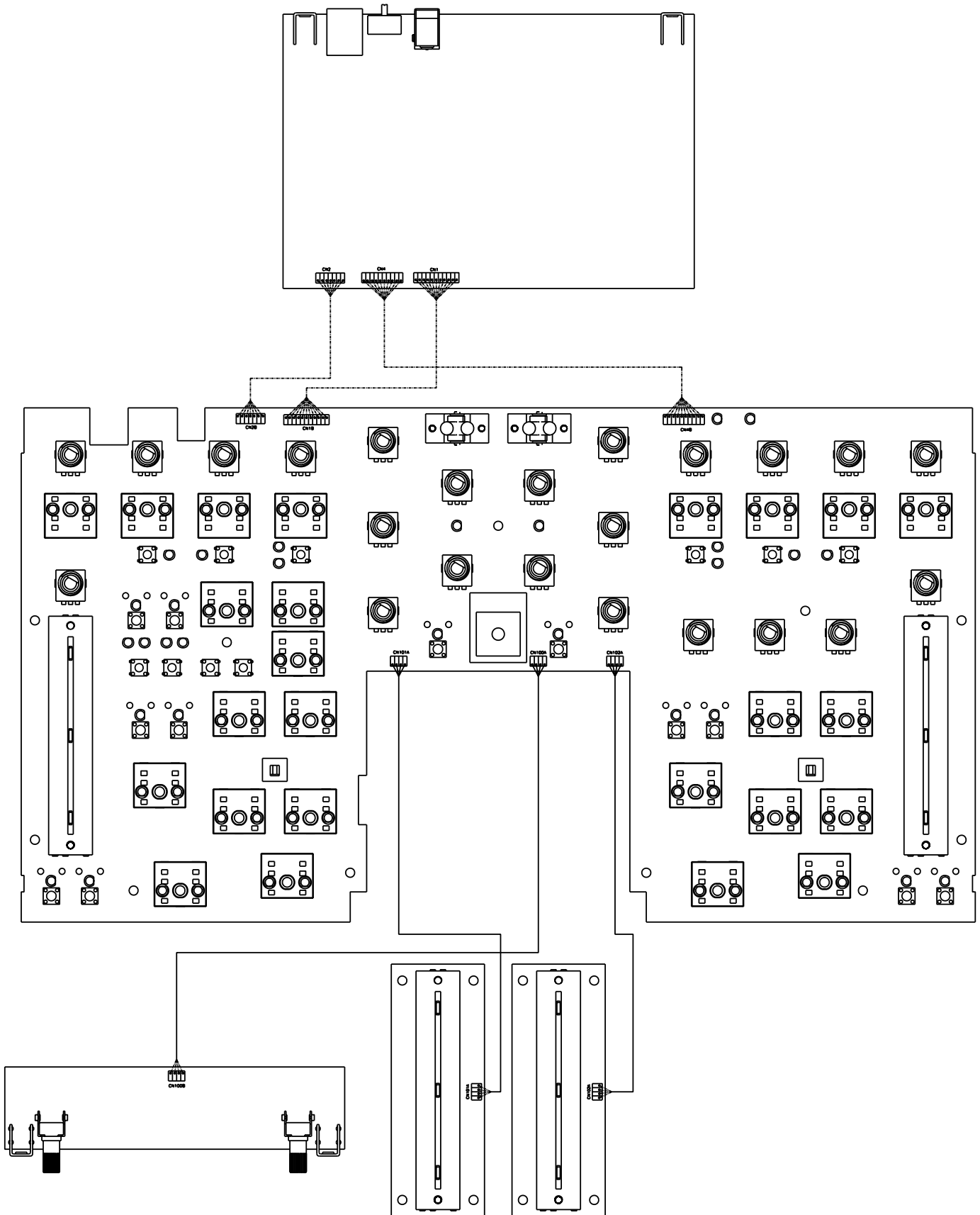

PACKING DIAGRAM

MODEL: TR-1(DM & EX)

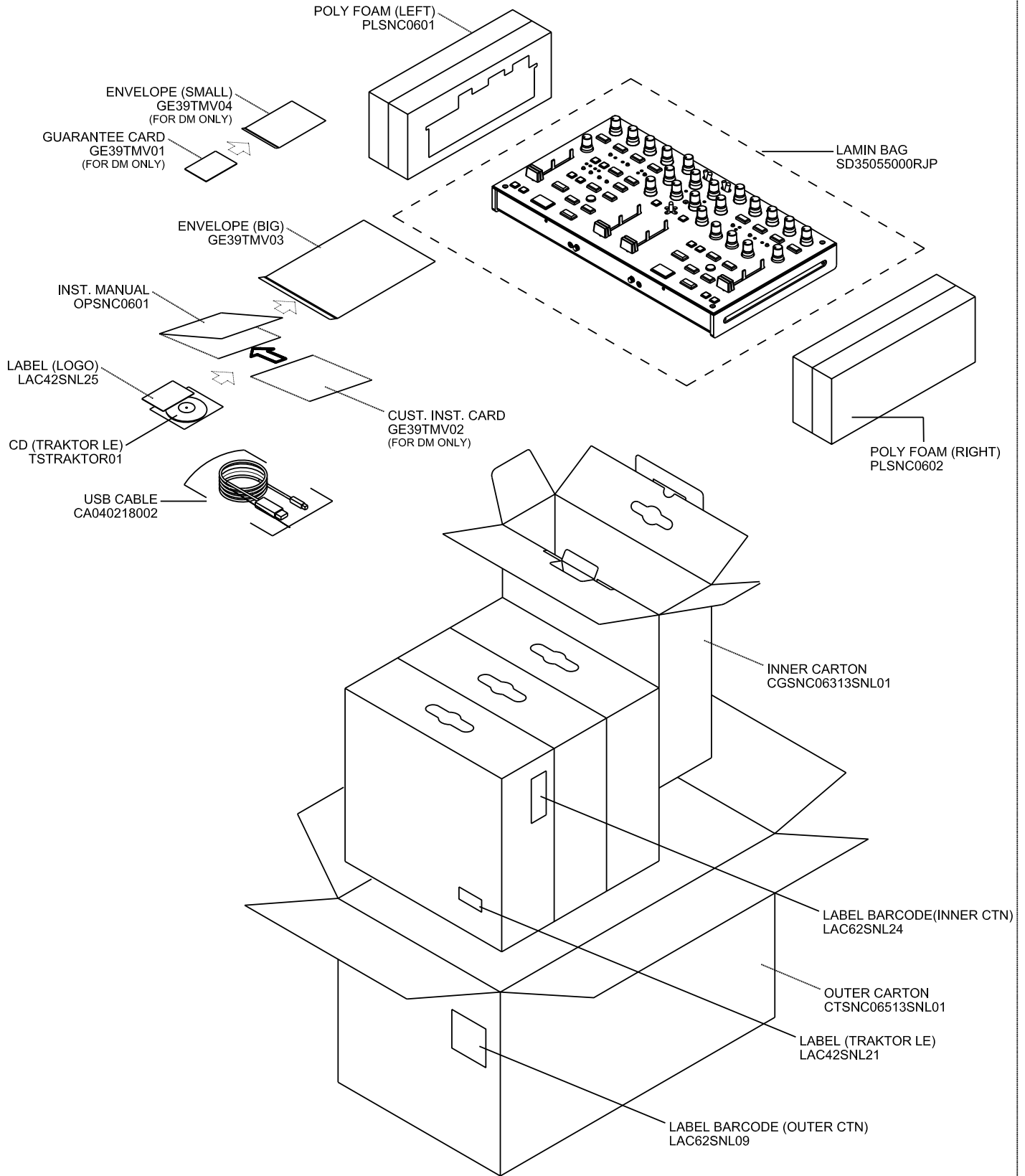

1 CARTON = 4 SETS

EXPLODED VIEW
MODEL: TR-1(DM & EX)

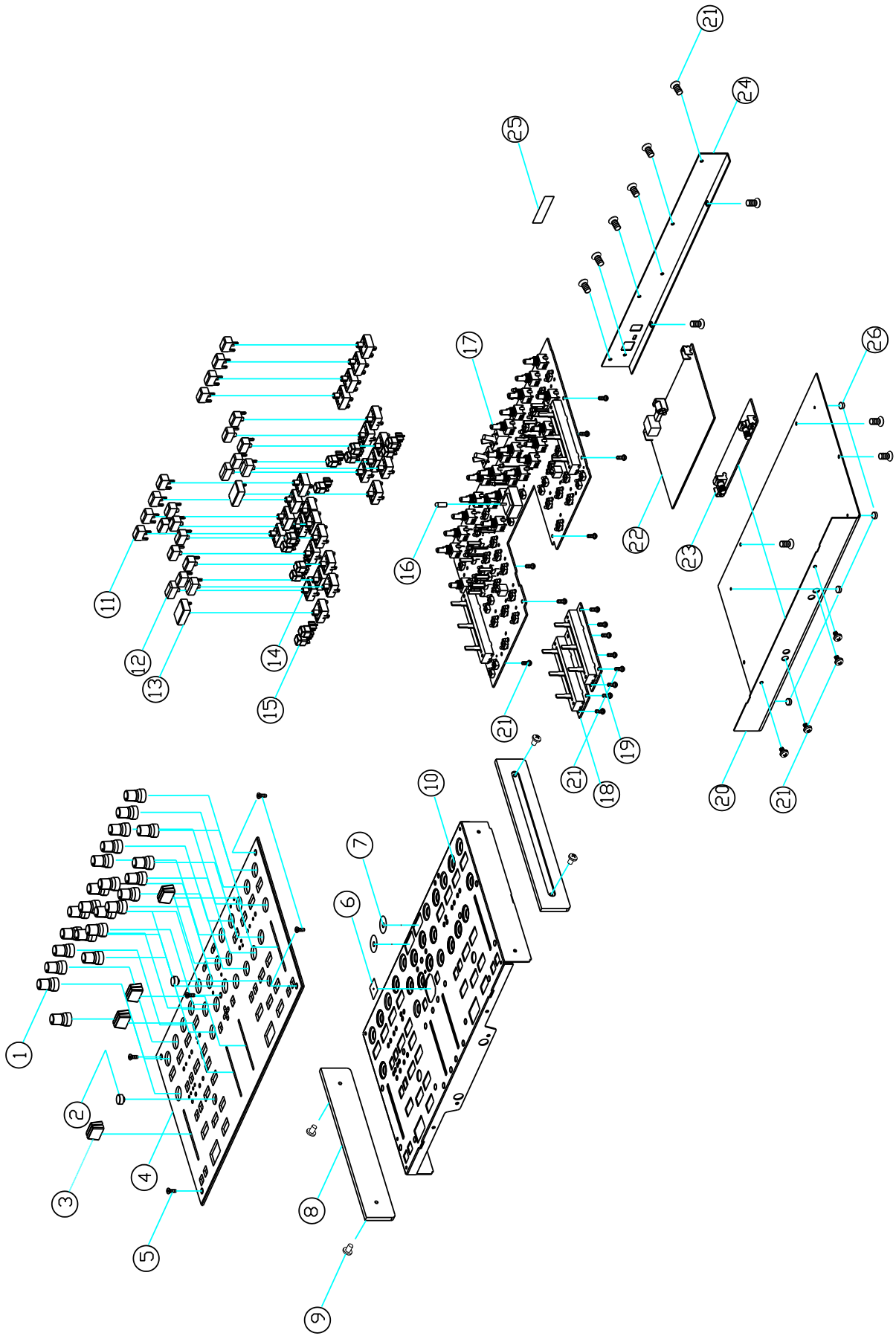

TR-1 (DM & EX) BOM

Lvl	Item #	Specs	Qty	P.Location
1	BAYV-201010	FADER CAP (B)/BLACK/WHITE	4	3
1	CGSNC06313SNL01	INNER CARTON (SNC06)	1	
1	CTSNC06513SNL01	MASTER CARTON (SNC06)	0.25	
1	GE39TMV01	GUARANTEE CARD	1	For DM Only
1	GE39TMV02	CUSTOMER INSTRUCTION CARD	1	For DM Only
1	GE39TMV03	ENVELOPE (BIG)	1	
1	GE39TMV04	ENVELOPE (SMALL)	1	For DM Only
1	LAC42SNL21	LABEL (TRAKTOR LE)	1	
1	LAC42SNL25	LABEL (LOGO)	1	
1	LAP67YAH261	LABEL (BLACK MARKING)	1.5	
1	MT513000501	FACE PLATE (SNC06)	1	4
1	NM5106104	VELVET CARPET (ROUND)	2	7
1	NM5106105	VELVET CARPET (SQUARE)	1	6
1	OPSNC0601	INSTRUCTION MANUAL (JAPANESE & ENGLISH VERSION)	1	
1	PLSNC0601	POLY FOAM (LEFT)	1	
1	PLSNC0602	POLY FOAM (RIGHT)	1	
1	PT5110616	ROTARY KNOB (SMALL) /D-D/ GOLD	23	1
1	PT511062701	PUSH SWITCH KNOB (SMALL) SPRAYING SILVER	2	2
1	SC0308AINI	HEX HEAD SCREW (FLAT) (M3X8MM)	5	5
1	SD35055000RJP	LAMIN BAG	1	
1	TSTRAKTOR01	CD (TRAKTOR LE) WITH LICENSE NUMBER	1	
1	TWSNC06SNL01	MIDI CONTROLLER TR-1 (DM) ASS'Y	1	
2	BAPC080406-2B	BUTTON GUIDE	25	14
2	BAPC082415	BUTTON (24X15)	2	13
2	BATM-182-808-15	RUBBER FOOT	4	26
2	CA040218002	USB CABLE (BLACK) + CORE	1	
2	K46-1	CABLE TIE	2	27
2	LAC22SNL10	SERIAL NO. LABEL	1	25
2	LAC62SNL09	LABEL BARCODE (MASTER CARTON) 1SET=2PCS	0.25	
2	LAC62SNL24	LABEL BARCODE (INNER CARTON)	1	
2	MT5110601	STICK KNOB	1	16
2	MT512020301	SUPPORT PLATE (SNC06)	1	10
2	MT512040601	REAR PANEL (SNC06)	1	24
2	MT512040701	SIDE PANEL (SNC06)	2	8
2	MT513030401	BOTTOM CHASSIS (SNC06)	1	20
2	PT5110617	8MM ANGULAR TAKT SWITCH KNOB	12	15
2	PT5110619	BUTTON (15*8)	19	11
2	PT5110620	BUTTON (18*9)	4	12
2	SC0305BIBI	SCREW (BINDING HEAD) 3X5MM	37	21
2	SC0306SINI	HEX HEAD SCREW (M3X6MM)	4	9
2	TWPC09S00801	PCB A' SSY PANEL	1	
3	PC09S00801	PC BOARD PANEL	1	
3	TWPC09S008A01	PCB A' SSY PANEL	1	17
4	AA397644J	TERMINAL M1698 1P	2	T1, 2
4	AA821679X	SPACER SLIDE T1.6MM	2	
4	CN0420002001	4P CONNECTOR WIRE L=200MM	3	CN100A
4	CN0720002501	7P CONNECTOR WIRE L=250MM	1	CN2B
4	CN1020003001	10P CONNECTOR WIRE L=300MM	1	CN4B
4	CN1120002501	11P CONNECTOR WIRE L=250MM	1	CN1B
4	DI1SS133T5	DIODE 1SS133	52	D142, 145, 148, 151, 153, 155, 157, D159~199, 200~203
4	EC10616TS	E. CAP 10UF/16V (7MM)	1	C117
4	IC74HC573AP	IC TC74HC573AP DIP20	5	IC100, 102, 106, 108, 110
4	ICTC4051BP	IC TC4051BP DIP16	4	IC112~IC115
4	LDL-7104IT	LED L-7104IT RED / COLORED LENS TRANSPARENCY	10	LD100, 101, 164, 165, 168~171, 176, LD177
4	LDL-7104SRC-E	LED SUPER BRIGHT RED, WATER CLEAR, φ3	20	LD102~117, 137, 139, 140, 142
4	LDL-7104YT	LED YELLOW, YELLOW TRANSPARENT, φ3	4	LD166, 167, 174, 175
4	LDSDPB31D0C0	LED BLUE, CLEAR, φ3	30	LD118~136, 138, 141, 143~147, 149, LD151, 172, 173
4	LDSDPW31G0C0	LED WHITE, CLEAR, φ3	14	LD148, 150, 152~163

Lvl	Item #	Specs	Qty	P.Location
4	PT111040105	HOLDER LED 10.5MM	16	LD100, 101, 164~177
4	R10216T5	RESISTOR 1K 1/16W	8	R100, 101, 106~111
4	R10316T5	RESISTOR 10K 1/16W	8	R138~145
4	R12116T5	RESISTOR 120 OHM 1/6W	2	R103, 122
4	R56116T5	RESISTOR 560 OHM 1/6W	2	R102, 113
4	R68016T5	RESISTOR 68 OHM 1/6W	9	R104, 105, 123, 132~137
4	SWRKJXK122400Y	SWITCH RKJXK122400Y	1	JS100
4	SWSKHHDDHA010	SWITCH SKHHDDHA010 H=17MM/0.98N_TYPE	10	SW151, 153, 155, 170, 171, 174, 175, SW178, 179, 183
4	SWSKPDALD010	ON/OFF TOUCH SWITCH 5MM 0.78N DIP	25	SW142, 145, 148, 150, 160, 162~164, SW166, 167, 169, 173, 180, 184, 185, SW187~191, 193, 197~199, 200
4	SWSKRGADD010	SWITCH SKRGADD010 BLACK H=5MM/1.27N_TYPE	12	SW157, 159, 161, 165, 168, 172, 177, SW181, 182, 186, 192, 201, 192, 201
4	SWSL10020F-0202	SWITCH SL10020-0202-12PA	2	SW194, 196
4	SWSPEA12MC02	ON/OFF PUSH SWITCH DUAL LINE (NON LOCK)	2	SW176, 195
4	TC104Z050B	CAPACITOR 0.1UF /50V F +80% -20%	9	C100, 102, 106, 108, 110, 113~116
4	TRA1296Y	TRANSISTOR 2SA1296	8	Q100, 101, 106~108, 117~119
4	TRDTC114YST	TRANSISTOR DTC114YS	11	Q102~104, 120~127
4	VRR10302202	V. RESISTOR L=12.5MM 10KBC.C	2	VR116, 152
4	VRR10302203	V. RESISTOR L=12.5MM 10KB	3	VR149, 151, 154
4	VRR10302504	V. RESISTOR 10KB	8	VR112~115, 147, 148, 150, 153
4	VRR10302506	V. RESISTOR 10K 25MM	10	VR117, 122, 130~135, 144, 145
4	VRS10306015	V. RESISTOR 10K 60MM 15MM	2	VR142, 146
3	TWPC09S008B01	PCB A'SSY IF CURVE	1	23
4	TE622000401	CONNECTOR (4P 90 DEGREE)	1	CN100B
4	VRR10302011	RK09K1110-K20-C0-B103 (LM1=20 10KB)	2	VR100, 143
3	TWPC09S008C01	PCB A'SSY A IF	1	18
4	TE622000401	CONNECTOR (4P 90 DEGREE)	1	CN101B
4	VRS10306015	V. RESISTOR 10K 60MM 15MM	1	VR142
3	TWPC09S008D01	PCB A'SSY B IF	1	19
4	TE622000401	CONNECTOR (4P 90 DEGREE)	1	CN102B
4	VRS10306015	V. RESISTOR 10K 60MM 15MM	1	VR146
2	TWPC09S00901	PCB A'SSY CPU	1	22
3	AA397644J	TERMINAL M1698 1P	2	T01, 02
3	CS101J5003NPO	CHIP CAPACITOR SMD 100P/50V ±5% 0603 NPO-ROHS	1	C23
3	CS103K5003X7R	C. CAP 0.010UF 50V X7R, ±10% SMD 0603	6	C11~14, 25, 26
3	CS104K5003X7R	CHIP CAP 0.1UF/50V, X7R, ±10%, SMD 0603	9	C1~7, 24, 300
3	CS150J5003NPO	CHIP CAP. 15PF, SMD0603, ±5%, 50V, NPO	2	C18, 19
3	CS470J5003NPO	CHIP CAP. 47PF, SMD0603, ±5%, 50V, NPO	2	C8, 9
3	DIEN1SR154400SM	RECTIFIER DIODE 1SR154-400	1	D1
3	DISDRB051L-40	SCHOTTKY BARRIER DIODES RB051L-40	1	D2
3	ECS10616SMD	ALUMINUM ELECTROLYTIC CAPACITOR CHIP 10UF/16V EC-	1	C17
3	ECS107M16SMD	E. CAPACITOR 100UF/16V SMD 6.3 X 5.3MM	3	C10, 20, 22
3	ICADM708TAR	IC ADM708TARZ	1	IC4
3	ICBA033FP	IC (BA033FP)	1	IC300
3	ICTC74VHC126FT	IC TC74VHC126FT TSSOP14	1	IC1
3	ICTC74VHC132FT	IC TC74VHC32FT	1	IC2
3	ICTC74VHC14FT	IC TC74VHC14FT TSSOP14	1	IC6
3	ICYHFRS004	IC H8S/HD64F2212U+PROGRAM	1	IC3
4	ICH64F2212U	IC H8S/2212U	1	
3	JKCMS1410	USB CMS1410	1	J2
3	JKDJ-0702B-020	DC SOCKET 2.0MM	1	JK1
3	JW5206T	JUMPER WIRE (A.I.) 52MM	2	F1, 2
3	PC09S009	PC BOARD CPU	1	
3	R001220T	RESISTOR RSF2R12QJ 12Ω/2W	1	R300
3	RS000010J03	CHIP RES. 0 Ω 5% SMD 0603	1	R31
3	RS001010F03	CHIP RES. 10 Ω 1% SMD 0603	1	R34
3	RS001K10F03	CHIP RES. 1K Ω 1% SMD 0603	3	R10~12
3	RS002210F03	CHIP RES. 22 Ω 1% SMD 0603	2	R32, 33
3	RS004710F03	CHIP RESISTOR 47 OHM 1% 0603 SMD	8	R35~42
3	RS010010F03	CHIP RES. 100 Ω 1% SMD 0603	12	R15~18, 20, 22~26, 28, 29
3	RS010K10F03	CHIP RES. 10K Ω 1% SMD 0603	32	R1~4, 6~9, 15, 16, 19, 21, 27, 30, 46~63
3	RS01K510F03	CHIP RES. 1.5K Ω 1% SMD 0603	1	R14

Lvl	Item #	Specs	Qty	P.Location
3	RS05K610F03	CHIP RES. 5.6K Ω 1% SMD 0603	1	R13
3	SWSV68010F-0203	ON/OFF SLIDE SWITCH DOUBLE LINE 3T	1	SW2
3	TE682000621	S6B-PH-SM4	1	CN3
3	TE682000721	S7B-PH-SM4	1	CN2
3	TE682001021	S10B-PH-SM4	1	CN4
3	TE682001121	S11B-PH-SM4	1	CN1
3	XTM16000X6	CRYSTAL 16MHZ 49U SMD ROHS	1	X1

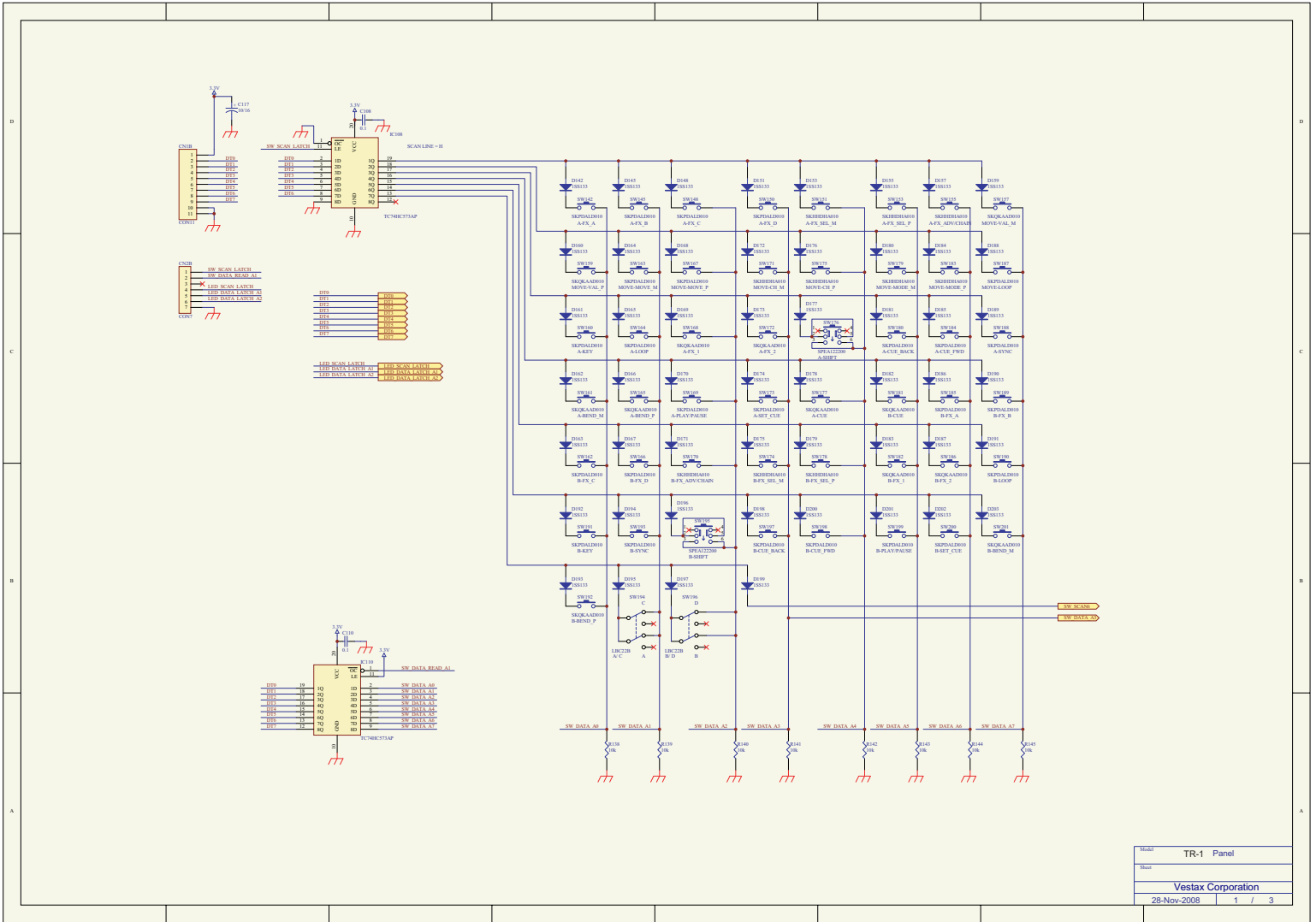

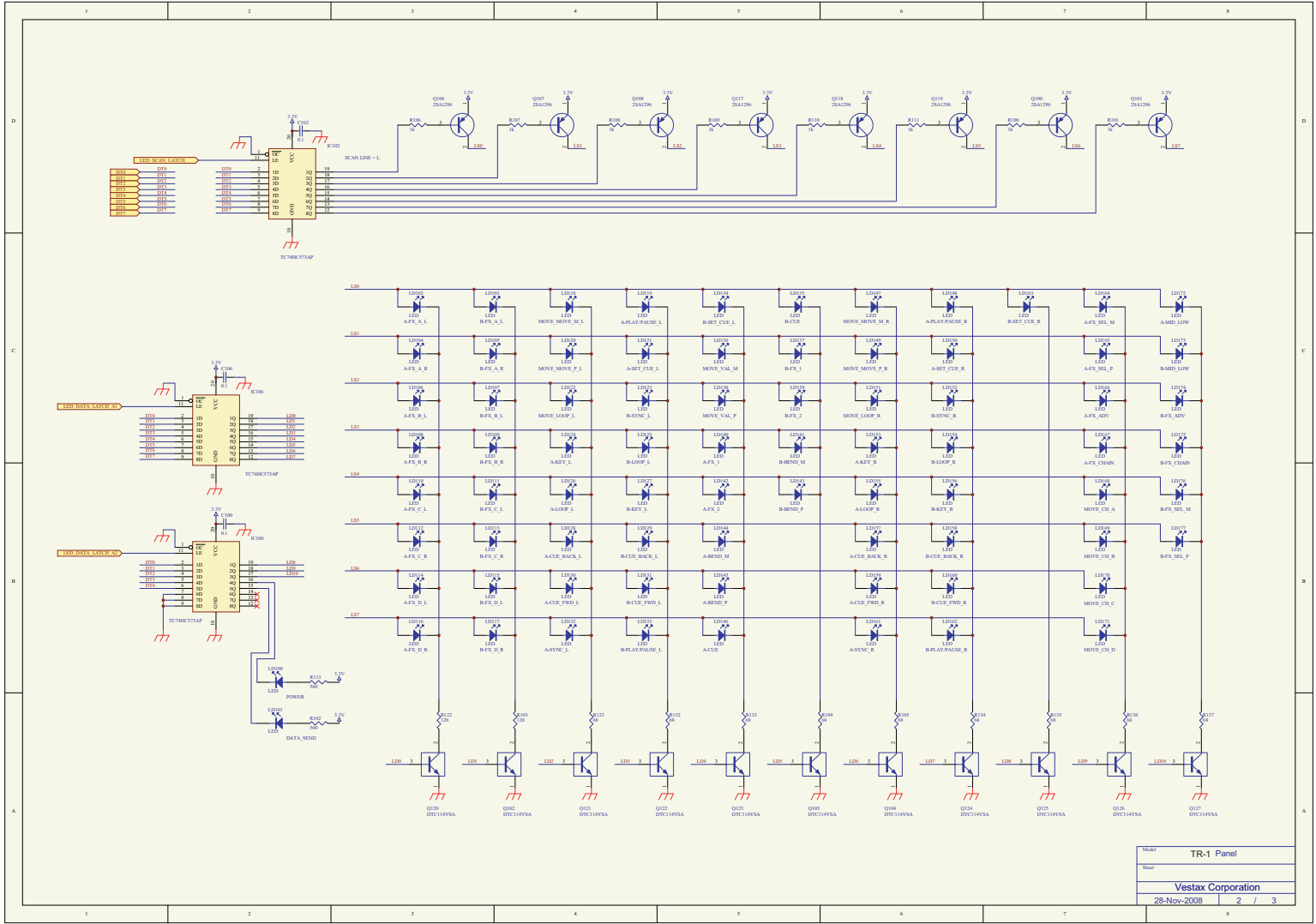

Model	TR-1 Panel
Sheet	
Vestax Corporation	
28-Nov-2008 2 / 3	

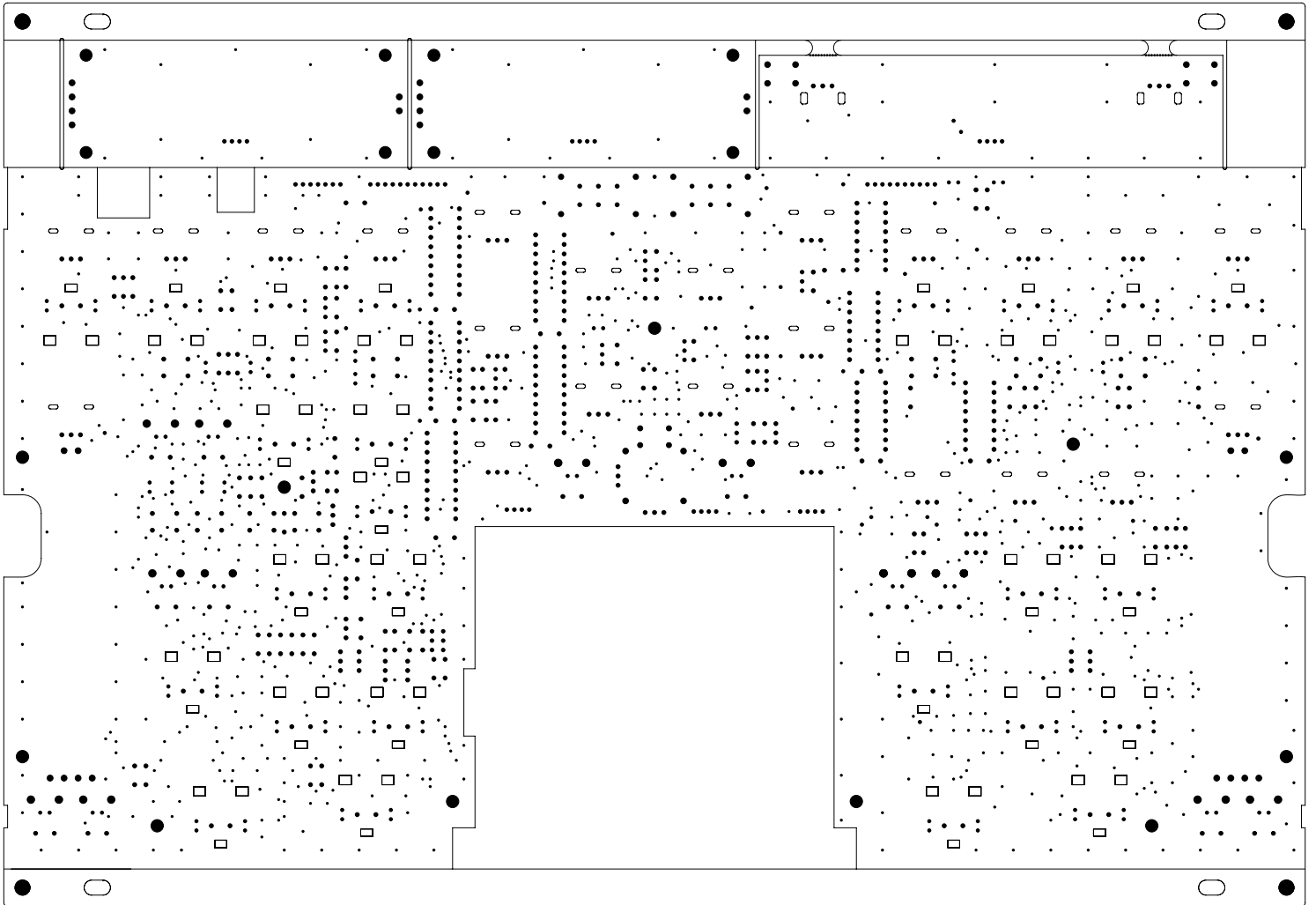

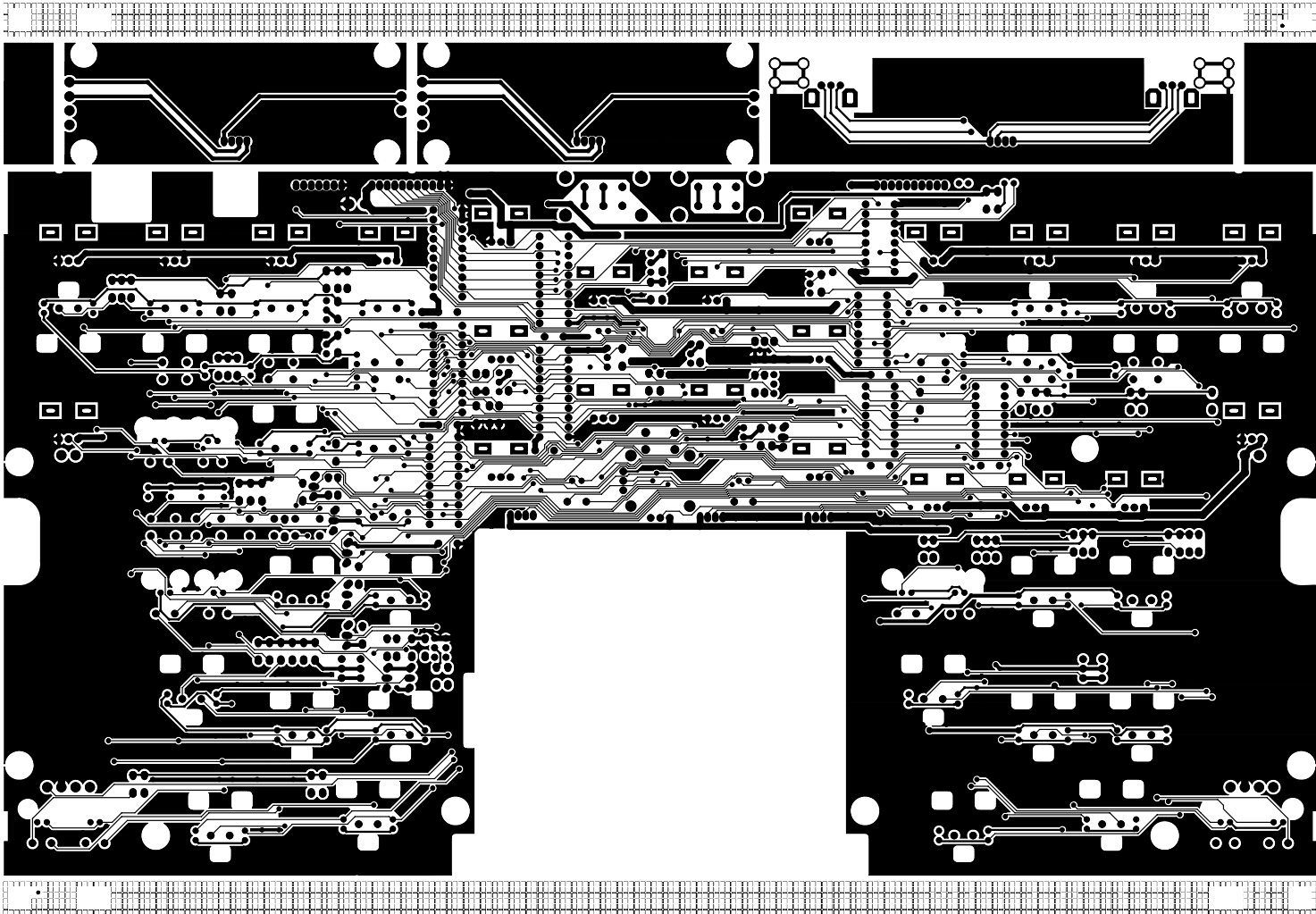

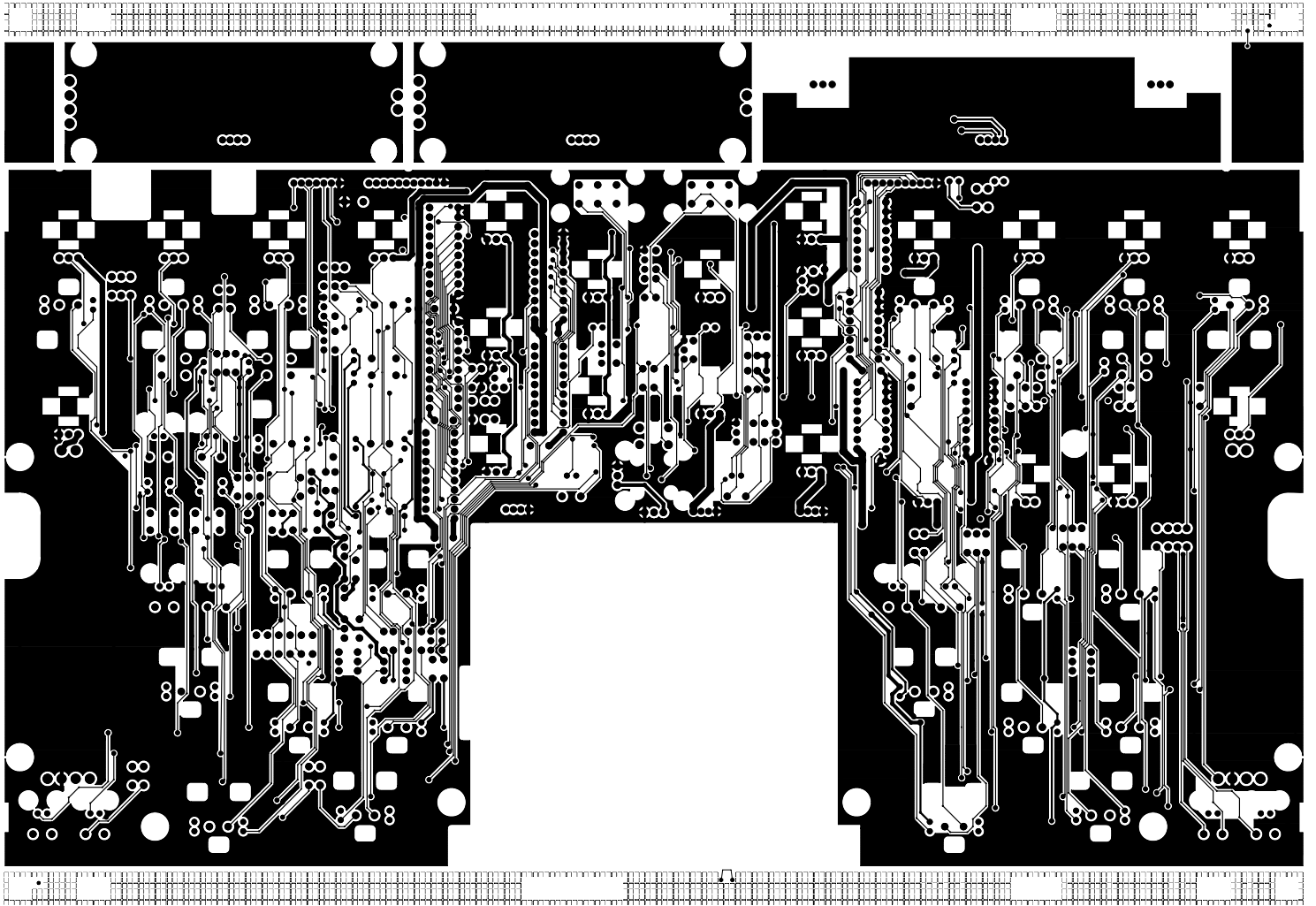

PC09S00801 YH-2035-2-2

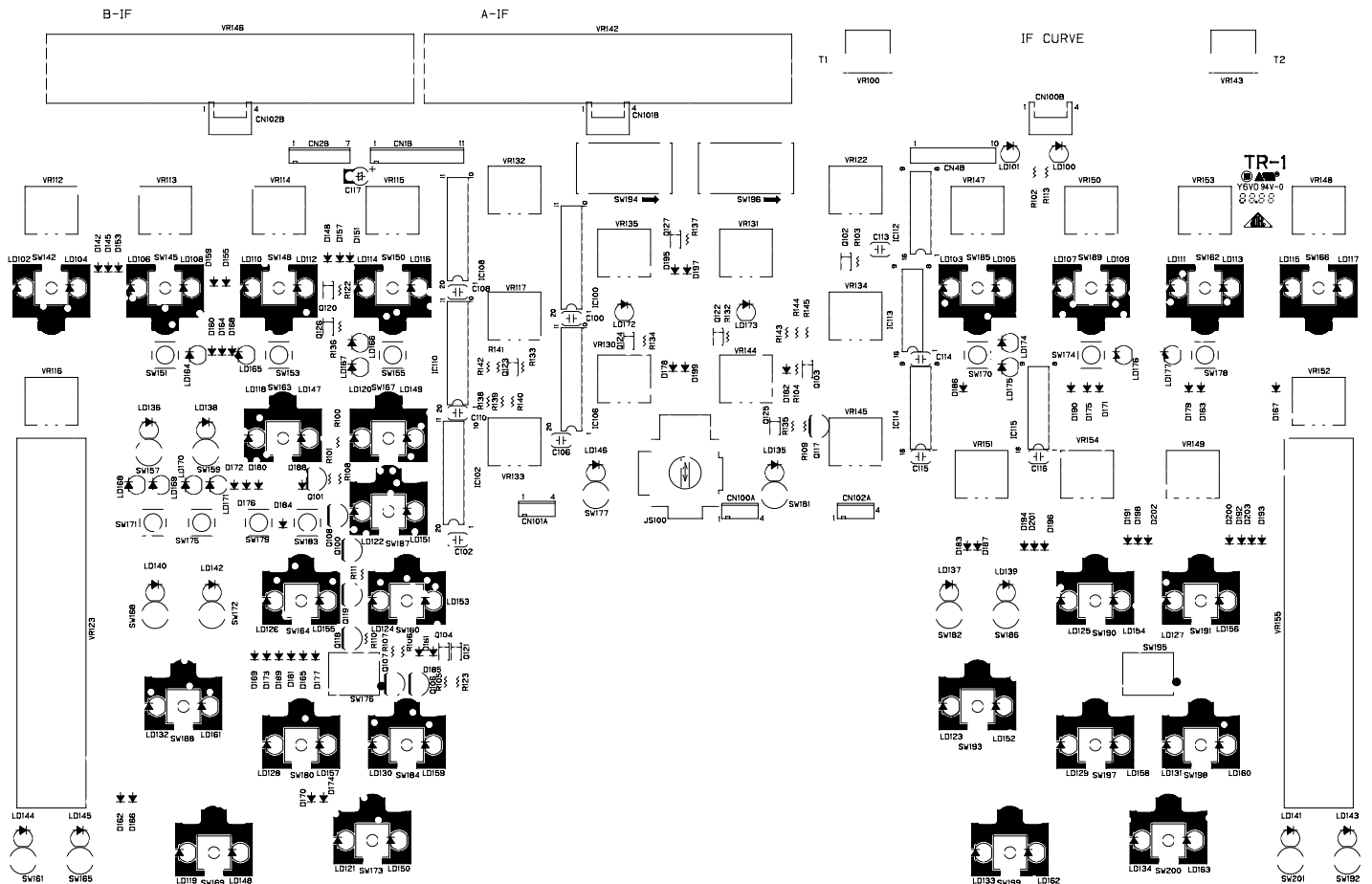

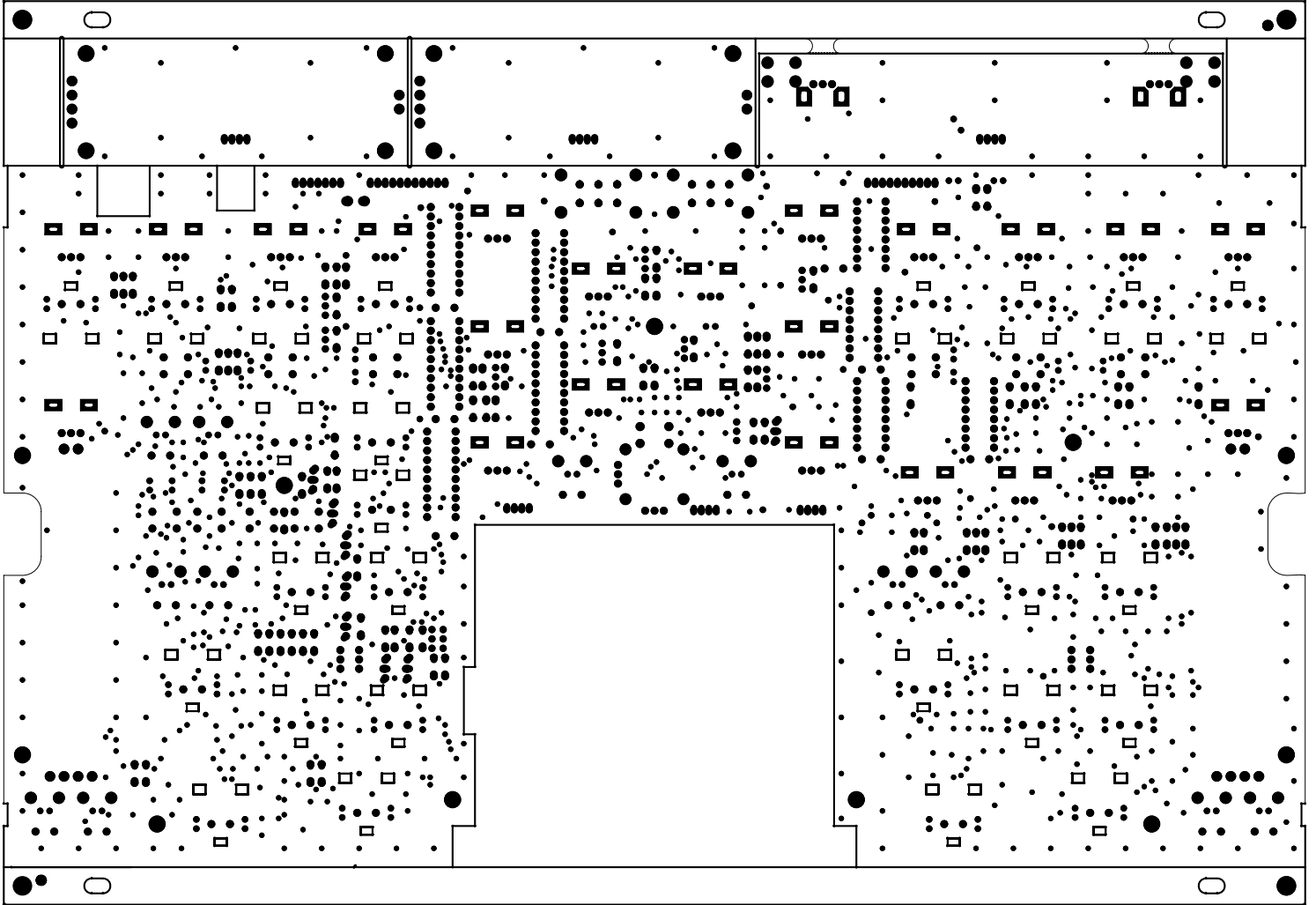

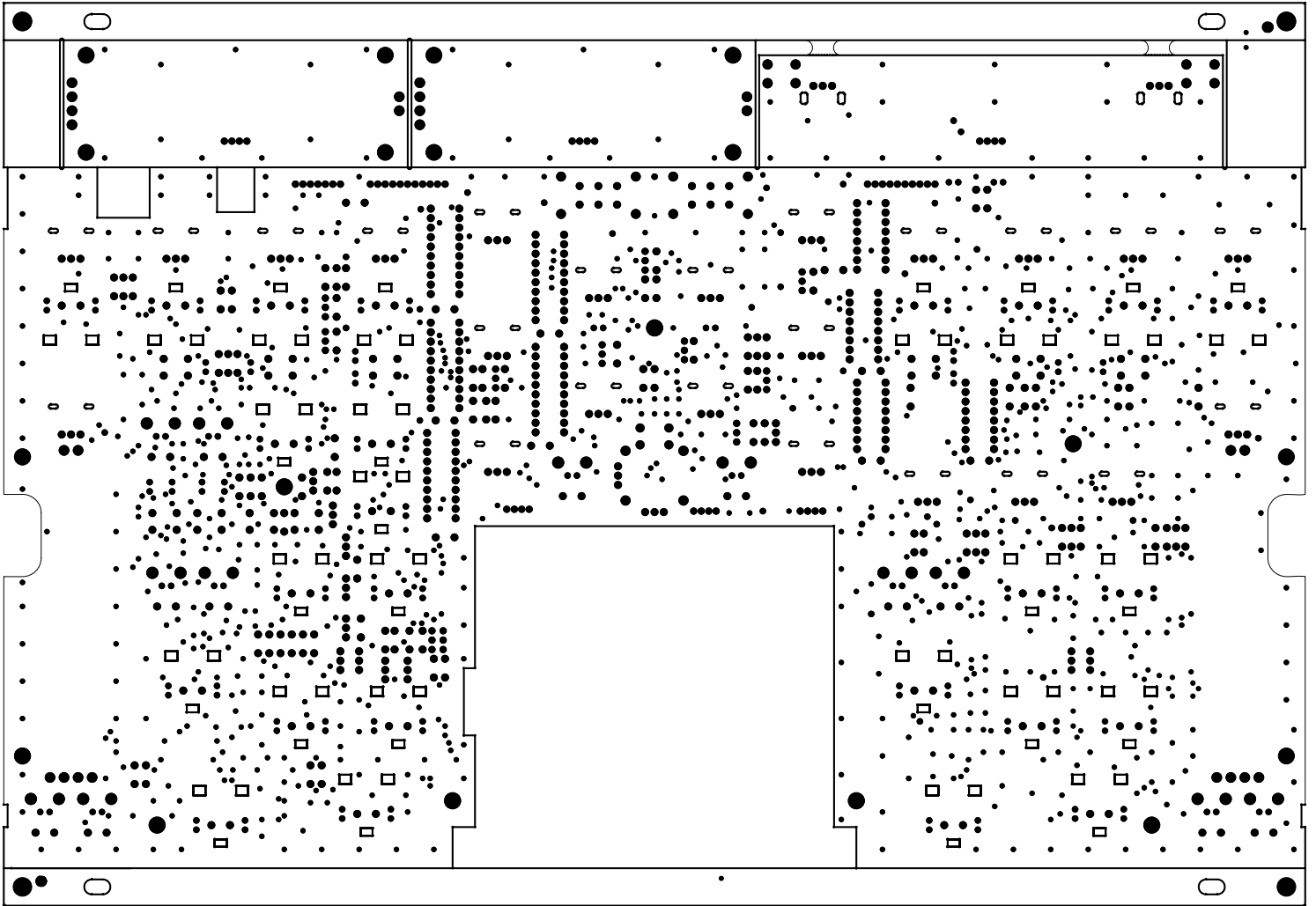

TOOL CHART			
No.	Size(MM)	Count	Legend
1	0.6000	872	+
2	0.8000	193	⊕
3	0.9000	85	⊖
4	1.0000	589	⊗
5	1.3000	4	⊙
6	1.4000	8	⊚
7	1.5000	28	⊛
8	2.0000	32	⊜
9	3.2000	8	⊝
10	3.3000	11	⊞
11	4.0000	4	⊠

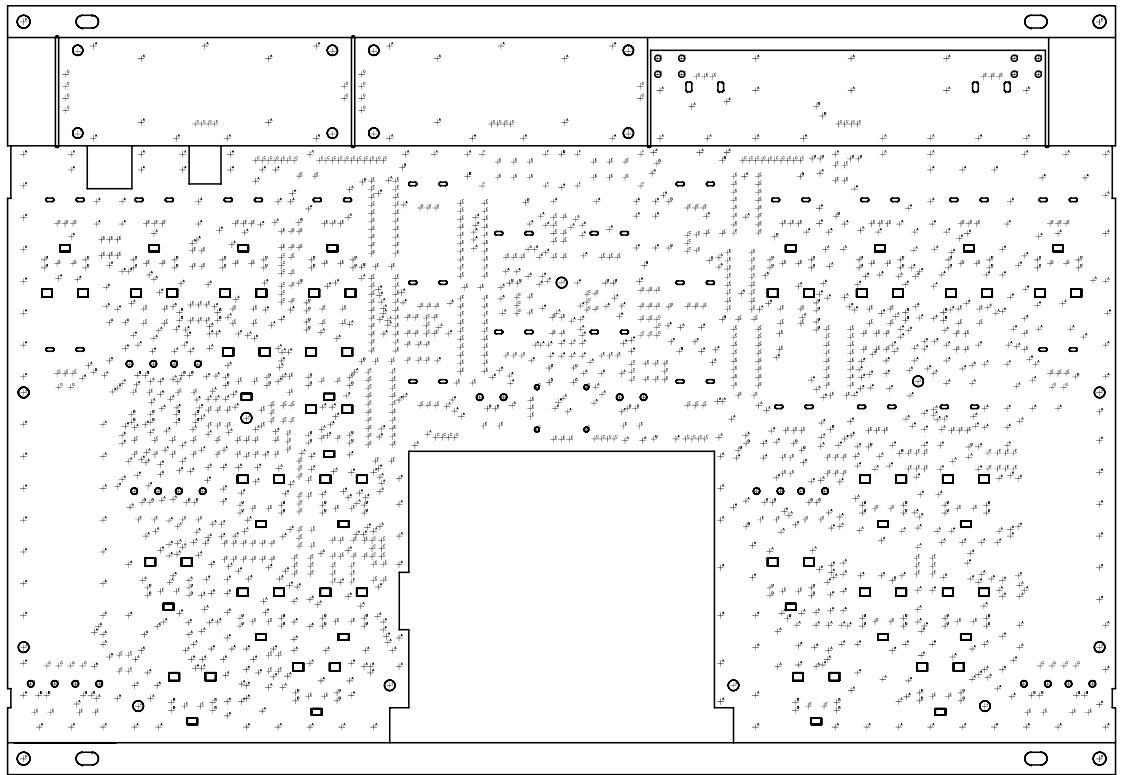

TR-1 T=1.6

※板外部品



G	12	3.937mil	0.1mm	NPTH
H	12	3.937mil	0.1mm	PTH
N	44	11.811mil	0.3mm	PTH
N	2172	15.748mil	0.4mm	PTH
I	12	27.559mil	0.7mm	PTH
B	36	31.496mil	0.8mm	PTH
F	16	35.433mil	0.9mm	PTH
A	24	39.37mil	1mm	PTH
C	8	51.181mil	1.3mm	PTH
O	8	62.992mil	1.6mm	NPTH
J	8	70.866mil	1.8mm	PTH
K	32	78.74mil	2mm	PTH
E	8	90.551mil	2.3mm	PTH
L	4	157.48mil	4mm	NPTH
	2396	Total		

