

STEREO AMPLIFIER AX-640

SERVICE MANUAL

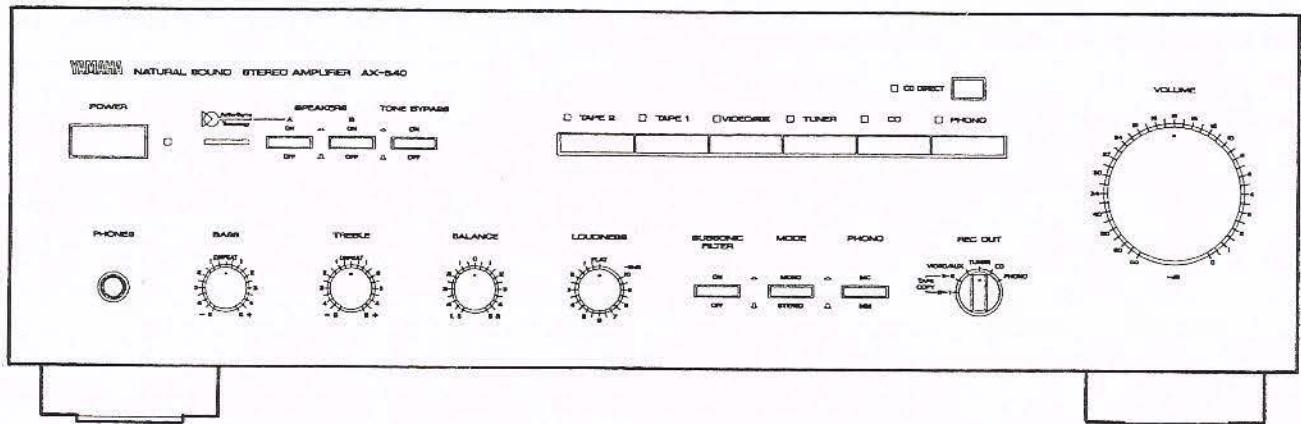

IMPORTANT NOTICE

This manual has been provided for the use of authorized Yamaha Retailers and their service personnel. It has been assumed that basic service procedures inherent to the industry, and more specifically Yamaha Products, are already known and understood by the users, and have therefore not been restated.

WARNING: Failure to follow appropriate service and safety procedures when servicing this product may result in personal injury, destruction of expensive components and failure of the product to perform as specified. For these reasons, we advise all Yamaha product owners that all service required should be performed by an authorized Yamaha Retailer or the appointed service representative.

IMPORTANT: The presentation or sale of this manual to any individual or firm does not constitute authorization, certification or recognition of any applicable technical capabilities, or establish a principle-agent relationship of any form.

The data provided is believed to be accurate and applicable to the unit(s) indicated on the cover. The research, engineering, and service departments of Yamaha are continually striving to improve Yamaha products. Modifications are, therefore, inevitable and specifications are subject to change without notice or obligation to retrofit. Should any discrepancy appear to exist, please contact the distributor's Service Division.

WARNING: Static discharges can destroy expensive components. Discharge any static electricity your body may have accumulated by grounding yourself to the ground buss in the unit (heavy gauge black wires connect to this buss).

IMPORTANT: Turn the unit OFF during disassembly and parts replacement. Recheck all work before you apply power to the unit.

CONTENTS

TO SERVICE PERSONNEL	1	ADJUSTMENTS	5
REAR PANELS	1~2	IC BLOCK	6
INTERNAL VIEW	2	WIRING	7
SPECIFICATIONS	3	PRINTED CIRCUIT BOARD	8~13
BLOCK DIAGRAM	4	SCHEMATIC DIAGRAM	14
DISASSEMBLY PROCEDURES	5	PARTS LIST	15~23

■ TO SERVICE PERSONNEL

1. Critical Components Information.

Components having special characteristics are marked Δ and must be replaced with parts having specifications equal to those originally installed.

2. Leakage Current Measurement (For 120V Model Only).

When service has been completed, it is imperative that you verify that all exposed conductive surfaces are properly insulated from supply circuits.

- Meter impedance should be equivalent to 1500 ohm shunted by 0.15 μ F.
- Leakage current must not exceed 0.5mA.
- Be sure to test for leakage with the AC plug in both polarities.

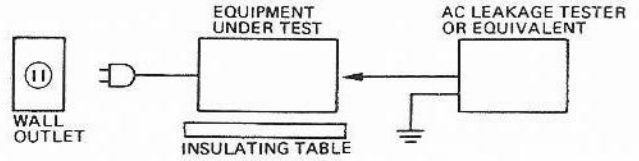

• POLARIZATION

This amplifier product is equipped with a polarized alternating-current lineplug (a plug having one blade wider than the other). This plug will fit into the power outlet only one way. This is a safety feature. (U,C Model only)

■ REAR PANELS

• Canadian model

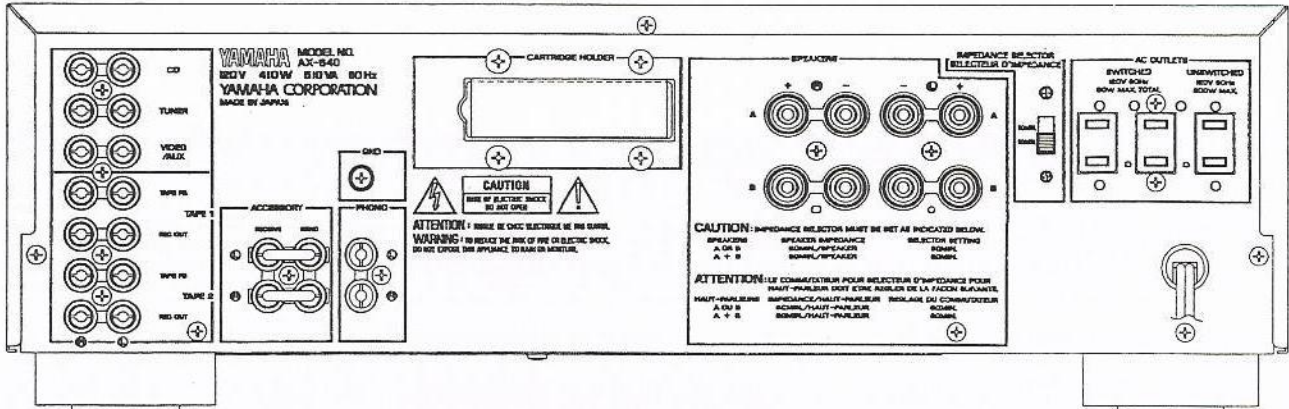

• Australian & British models

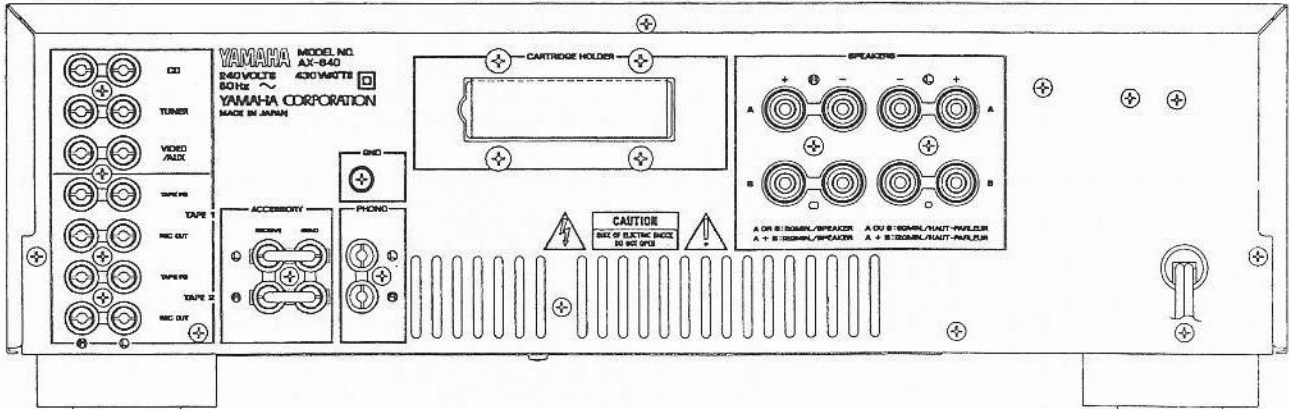

AX-640

• European model

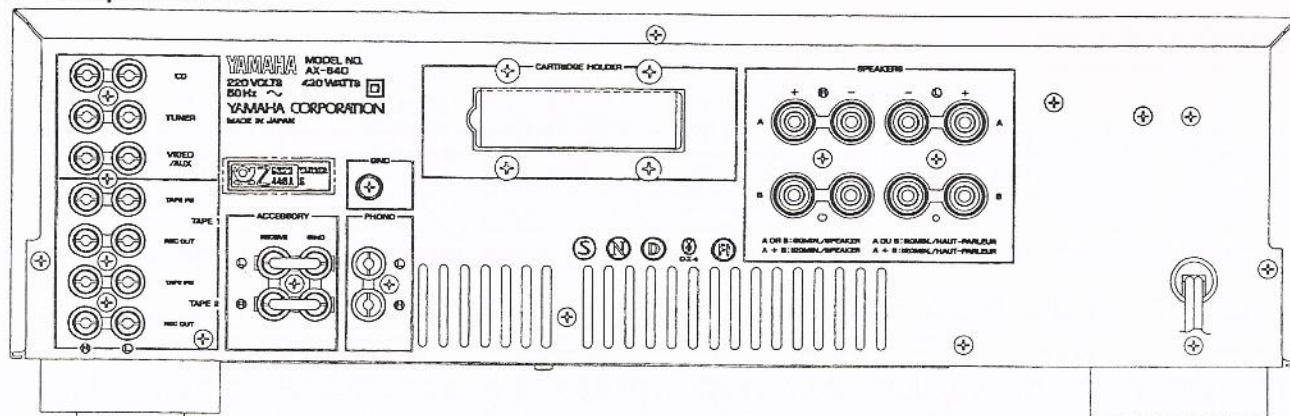

• General model

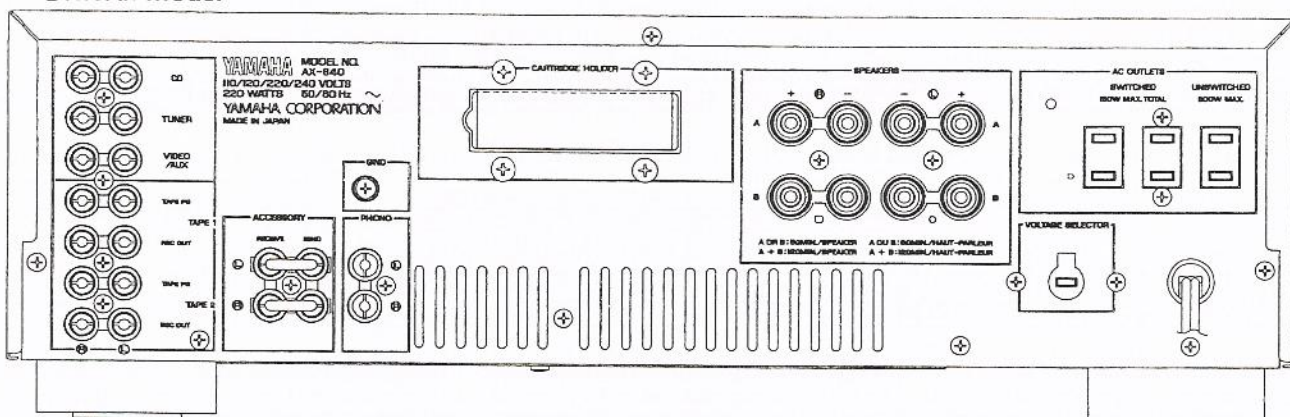

■ INTERNAL VIEW

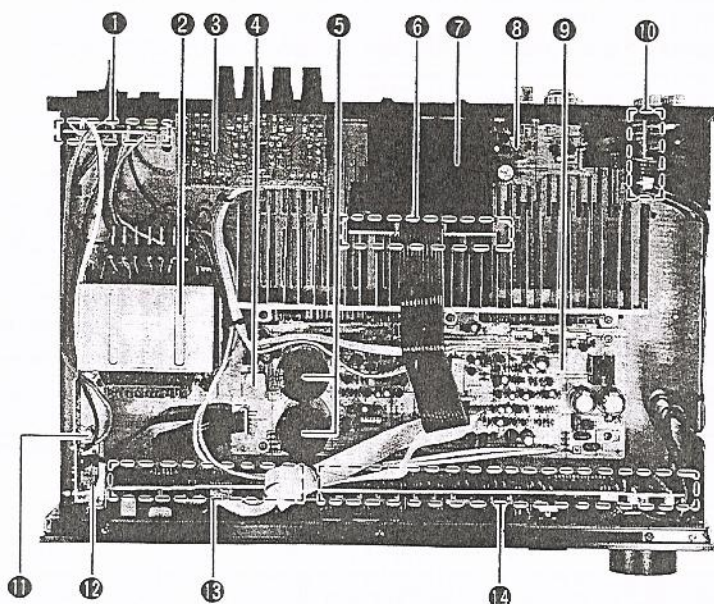

- ① SUB CIRCUIT BOARD (3)
- ② POWER TRANSFORMER
U model : XG093A00
C model : XG094A00
R model : XG095A00
A,B models : XG096A00
G model : XG097A00
- ③ SUB CIRCUIT BOARD (1)
- ④ BRIDGE DIODE : iH000870(4D4B41)
- ⑤ ELECTROLYTIC CAP
12000 μ F 71V : VH746400
- ⑥ MAIN CIRCUIT BOARD (6)
- ⑦ ROM BOX
- ⑧ MAIN CIRCUIT BOARD (3)
- ⑨ MAIN CIRCUIT BOARD (1)
- ⑩ MAIN CIRCUIT BOARD (4)
- ⑪ FUSE
U,C models : KB001520(7.0A 125V)
A,B,G models : KB002980(T2.5A 250V)
R model : KB001300(7.0A 250V)
- ⑫ POWER SWITCH
- ⑬ MAIN CIRCUIT BOARD (5)
- ⑭ MAIN CIRCUIT BOARD (2)

AX-640

SPECIFICATIONS

Minimum RMS Output Power Per Channel
 20 Hz - 20 kHz 0.01% THD 8Ω 85W
 0.015% THD 6Ω 100W

Dynamic Power Per Channel (by IHF Dynamic Headroom Measuring Method)
 U.S.A., Canadian and General models
 8Ω/6Ω/4Ω/2Ω 160W/200W/230W/250W
 Australian, European and British models
 8Ω/6Ω/4Ω/2Ω 140W/170W/200W/220W

DIN Standard Output Power Per Channel (European model)
 1 kHz 1% THD 4Ω 110W

Dynamic Headroom (U.S.A., Canadian and General models)
 8Ω 2.75 dB
 6Ω 3.01 dB

IEC Power (European model)
 1 kHz 0.01% THD 8Ω 100W
 6Ω 110W

Power Bandwidth
 0.03% THD 42.5W 8Ω 10 Hz - 50 kHz

Damping Factor
 1 kHz 8Ω 100 or more

Input Sensitivity/Impedance
 Phono MC 160 μV 220Ω
 MM 2.5 mV/47 kΩ
 CD/VIDEO/TUNER/AUX/TAPE/VCR 150 mV/47 kΩ

Input Sensitivity (New IHF) (U.S.A., Canadian and General models)
 Phono MC 19 μV
 MM 0.27 mV
 CD/VIDEO/TUNER/AUX/TAPE/VCR 15.5 mV

Maximum Input Signal (1 kHz 0.01% THD)
 Phono MC 10 mV
 MM 150 mV

Output Level/Impedance
 REC OUT 150 mV 220Ω

Headphone Jack Rated Output/Impedance
 0.01% THD RL=8Ω 0.5V/120Ω

Frequency Response
 CD/VIDEO/TUNER/AUX/TAPE/VCR 20 Hz - 20 kHz, ±0.5 dB

RIAA Equalization Deviation
 20 Hz - 20 kHz,
 Phono MC ±0.5 dB
 MM ±0.3 dB

Total Harmonic Distortion 20 Hz - 20 kHz
 Phono MC to REC OUT, 3V 0.007%
 MM to PRE OUT, 3V 0.003%

Intermodulation Distortion
 CD/VIDEO/TUNER/AUX/TAPE/VCR
 Rated Output/8Ω 0.01%

Signal-to-Noise Ratio (IHF-A Network)
 Phono MC (500 μV Input Shorted) 76 dB
 MM (5 mV Input Shorted) 92 dB
 CD/VIDEO/TUNER/AUX/TAPE/VCR (Shorted) 102 dB

Signal-to-Noise Ratio (New IHF)
 U.S.A., Canadian and General models
 Phono MC 75 dB
 MM 75 dB
 CD/VIDEO/TUNER/AUX/TAPE/VCR 85 dB

Residual Noise (IHF-A Network) 140 μV

Channel Separation Vol -30 dB
 Phono MC, MM Input shorted
 1 kHz/10 kHz 75 dB/60 dB
 CD/VIDEO/TUNER/AUX/TAPE/VCR
 Input 5.1 kΩ
 Terminated 1 kHz/10 kHz 75 dB/60 dB

Tone Control Characteristics
 Bass
 Boost / Cut ±10 dB (20 Hz)
 Turnover frequency 350 Hz
 Treble
 Boost / Cut ±10 dB (20 kHz)
 Turnover frequency 3.5 kHz

Filter Characteristics
 Subsonic 15 Hz -12 dB/oct

Continuous Loudness Control (Level Related Equalization)
 Attenuation -40dB (1 kHz)

Gain Tracking Error
 U.S.A., Canadian and General models
 (0 - -60 dB) 2 dB

Power Supply
 U.S.A. and Canadian models AC 120V/60 Hz
 British and Australian models AC 240V/50 Hz
 European model AC 220V/50 Hz
 General model AC 110/120/220/240V 60/50 Hz

Power Consumption
 U.S.A. and Canadian models 410W
 Australian, European and British models 430W
 General model 220W

AC Outlets
 U.S.A., Canadian and General models
 Unswitched (1) 200W max.
 General model
 Switched (2) 150W max.
 U.S.A. and Canadian models
 Switched (2) 80W max.

Dimensions (W x H x D) 435 x 139 x 330.5 mm
 (17-1/8" x 5-1/2" x 13")

Weight 8 kg
 (17 lbs. 10 oz.)

* Specifications are subject to change without notice.

AX-640

• **Dimensions**

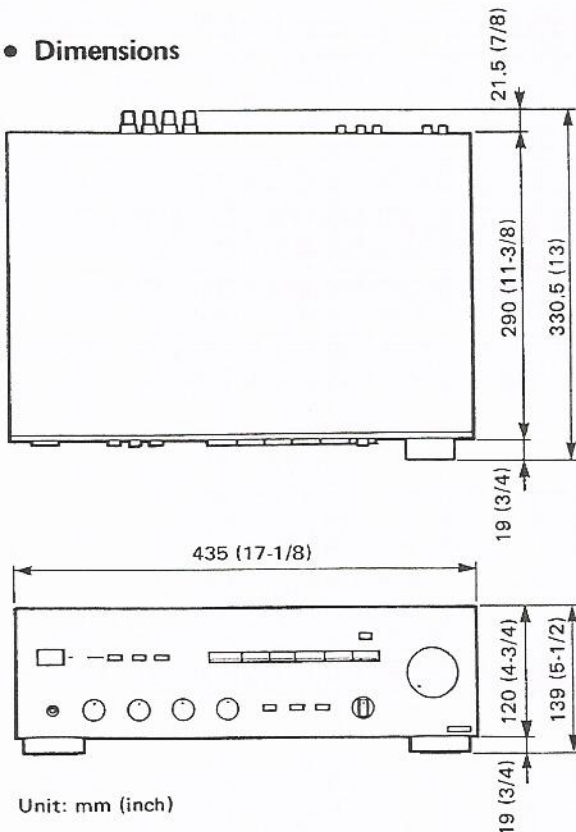

- (C) Canadian model
- (G) European model
- (A) Australian model
- (B) British model
- (R) General model

Unit: mm (inch)

BLOCK DIAGRAM

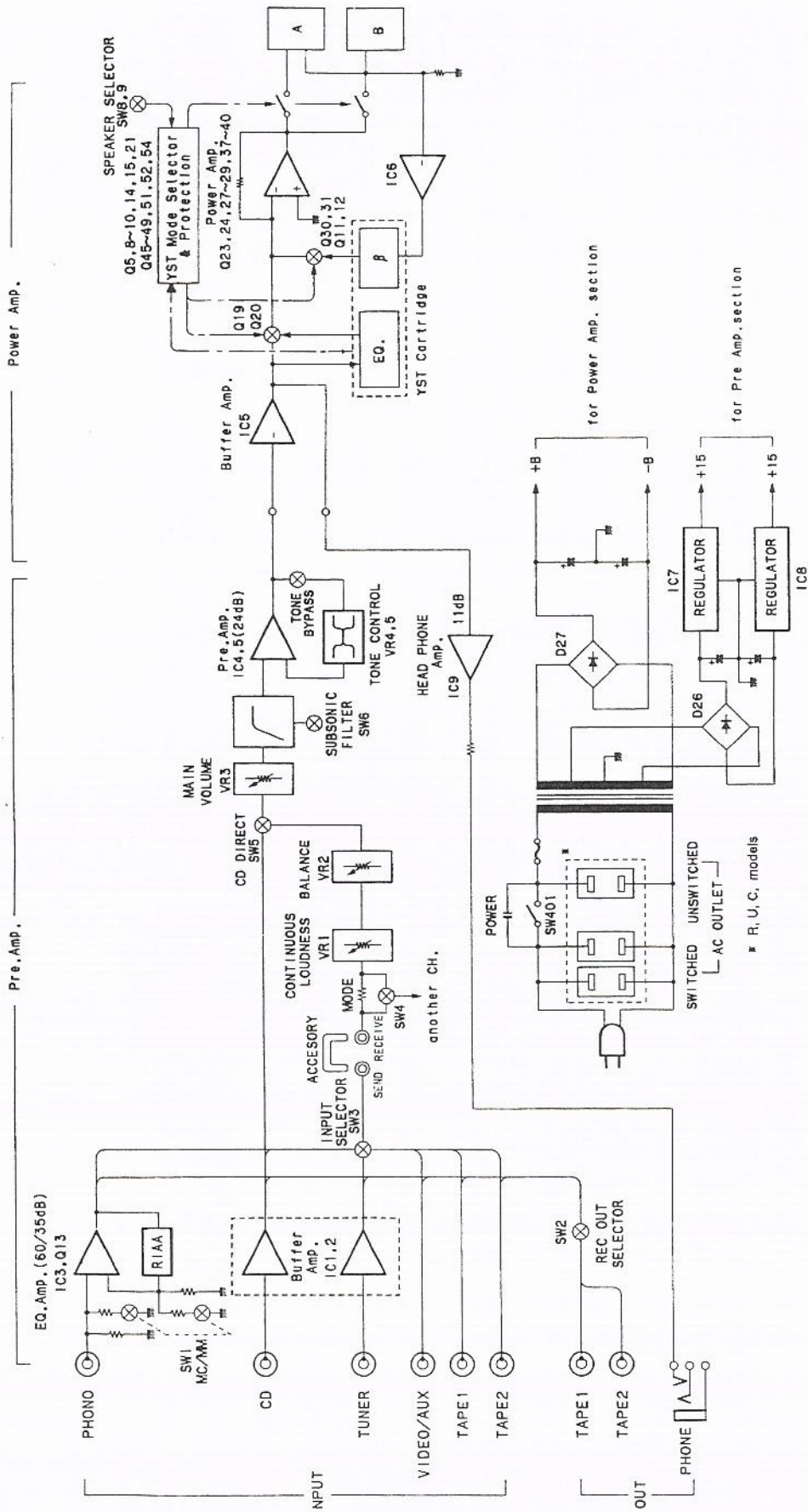

Speaker ON Position	A	B	A + B	
	YST Cartridge	YST Power Amp.	Normal Amp.	Speaker A: Terminal
Cartridge ON	Normal Amp.	Normal Amp.	YST Power Amp.	-
Cartridge OFF	Normal Amp.	Normal Amp.	Normal Amp.	Normal Amp.

AX-640

DISASSEMBLY PROCEDURES

(Removal parts in disassembly order as numbered.)

1. Removal of top cover

Remove 5 screws (①).

2. Removal of bottom cover

Remove 7 screws (②).

3. Removal of front panel

Remove 5 screws (③), and pull the front panel forward.

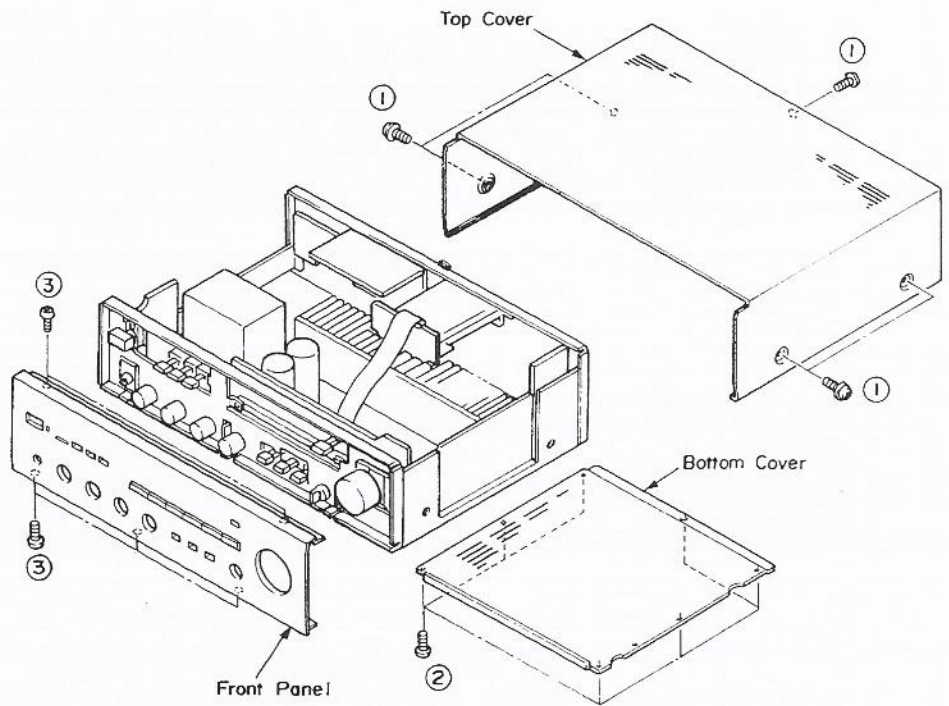

ADJUSTMENTS

● IDLING CURRENT ADJUSTMENT

When replacing the power and drive transistors, adjust idling current.

After the power has been turned on, age about 2 minutes in no signal and non loaded condition.

Adjust VR7(Lch) and VR8(Rch) so that the voltage across the terminal of R188 or R191 and R203 or R205 comes to $5\text{mV} \pm 1\text{mV DC}$.

	Test points	Adjustment points	Rating
Lch	R188 or R191	VR7	$5\text{mV} \pm 1\text{mV DC}$.
Rch	R203 or R205	VR8	$5\text{mV} \pm 1\text{mV DC}$.

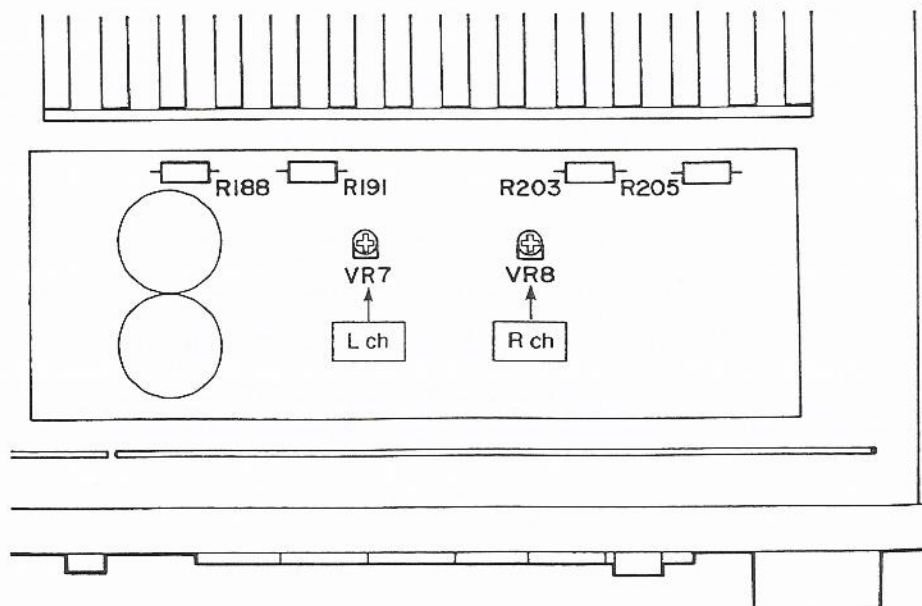

■ IC BLOCK

IC1,2,5 : μ PC4570G2-T1

IC6 : BA4558F

(Dual Ope-Amp.)

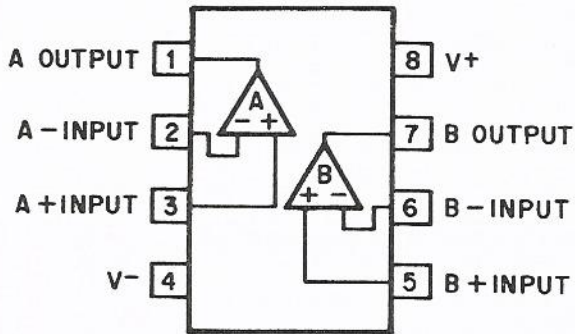

IC3 : μ PC4570HA

IC4 : NJM5532SD

IC9 : NJM4556S-A

(Ope-Amp.)

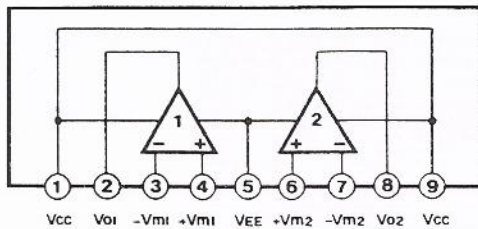

IC7 : NJM78M15FA

(Regulator)

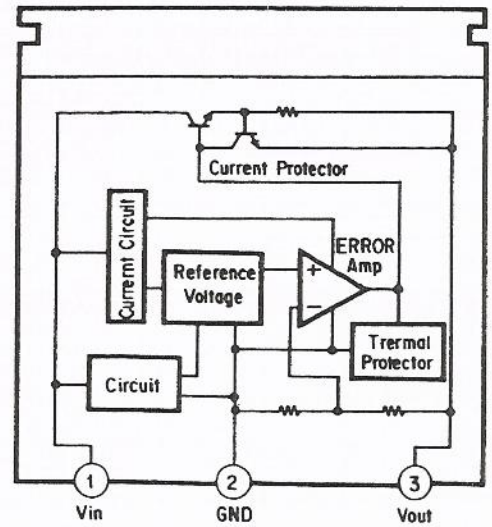

IC8 : NJM79M15FA

(Regulator)

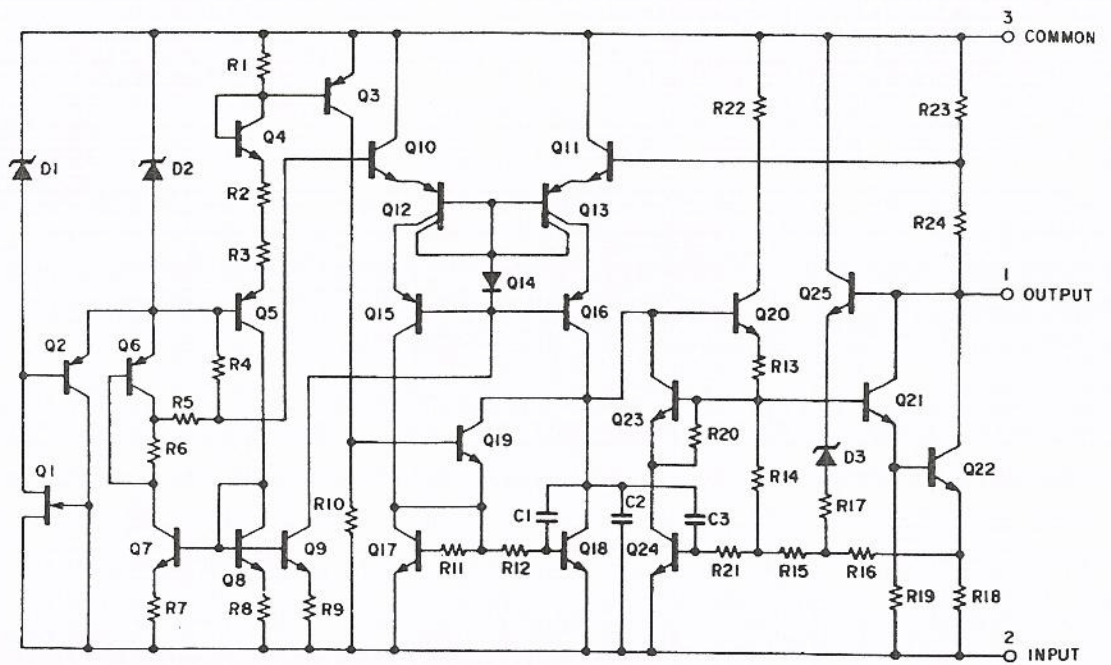

WIRING

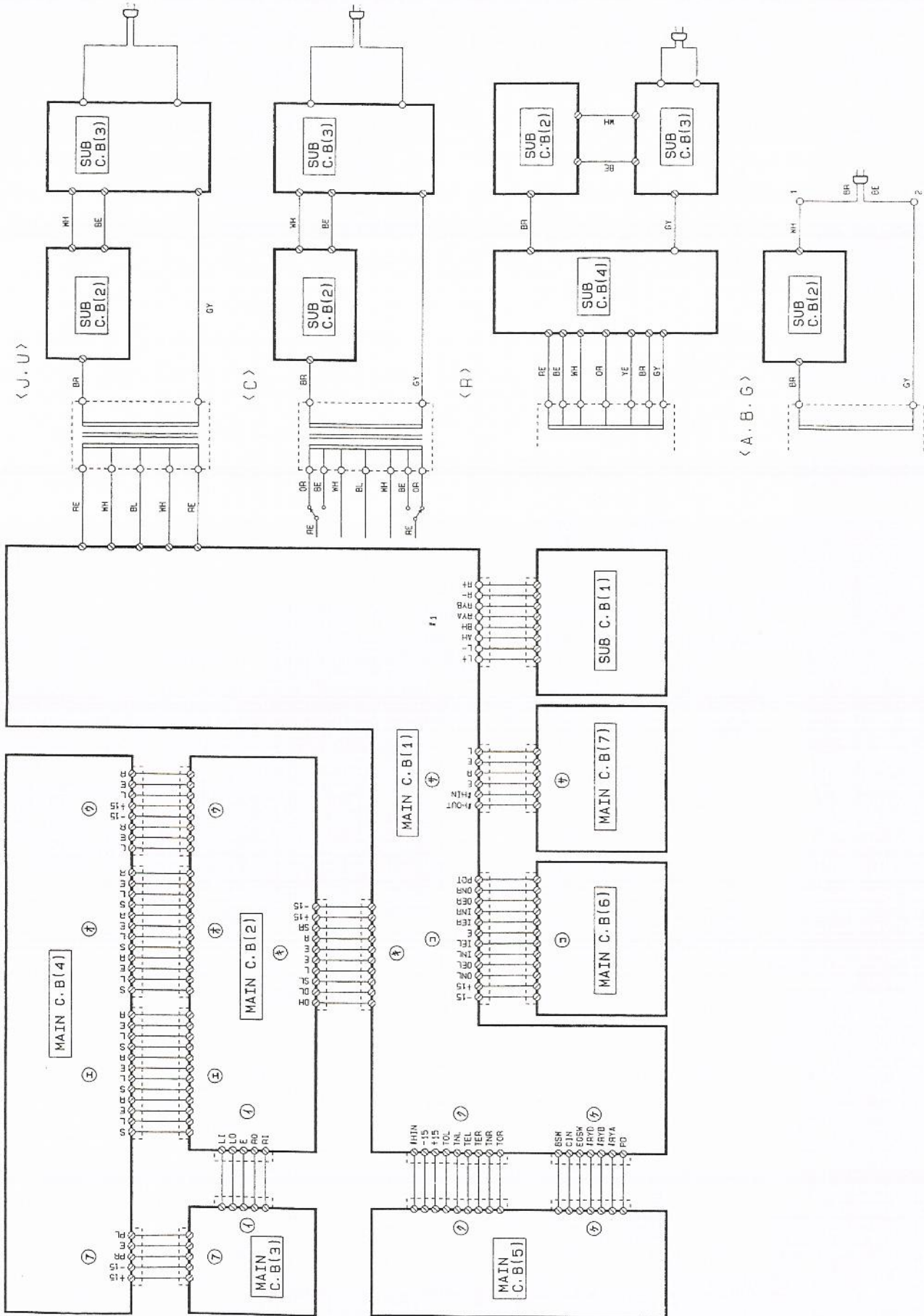

AX-640

AX-640

PRINTED CIRCUIT BOARD (Pattern side) Notes) 文字面 : Component side

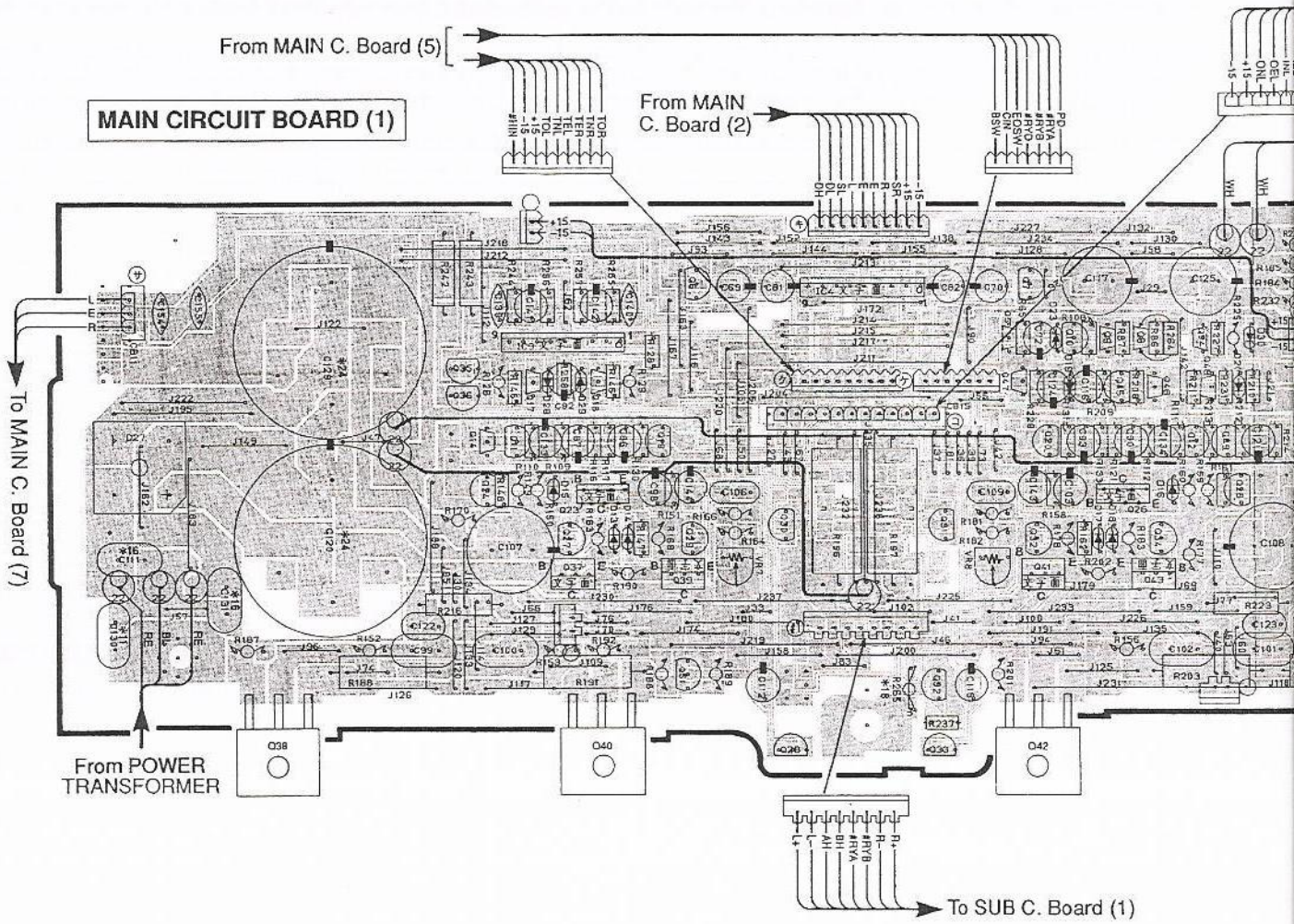

MAIN CIRCUIT BOARD (1) (Chip Side)

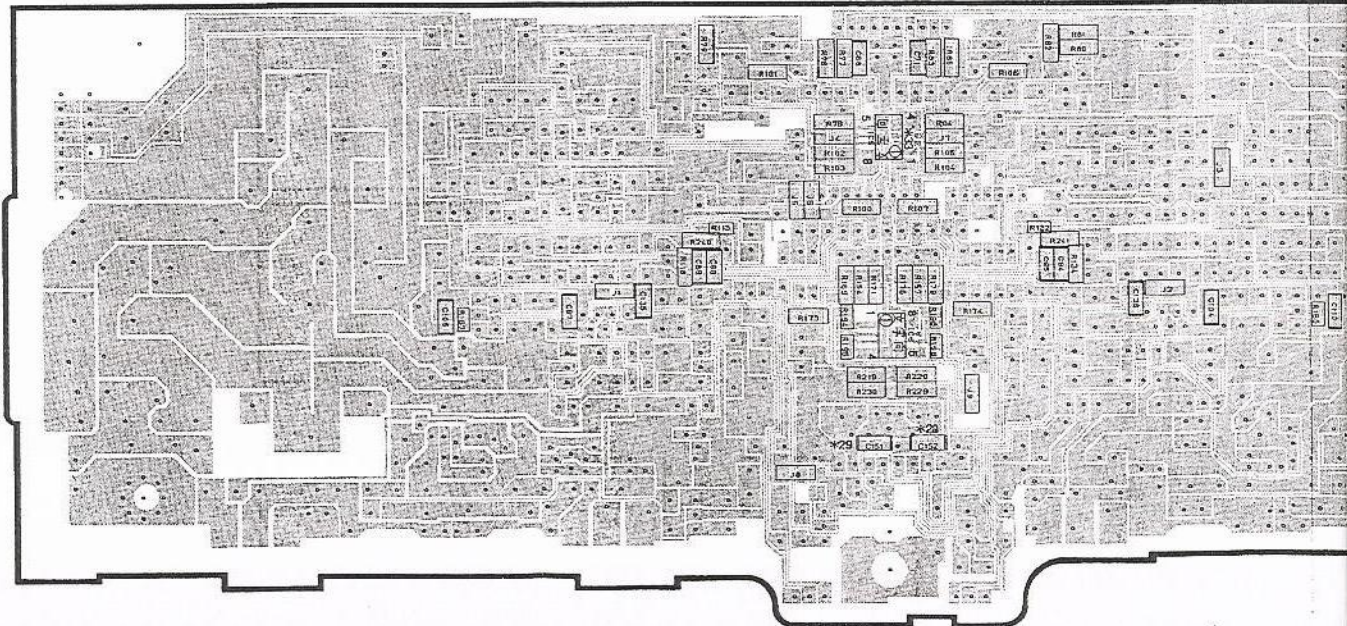

MAIN CIRCUIT BOARD (3)

PHONO

- ▬ MC
- MM

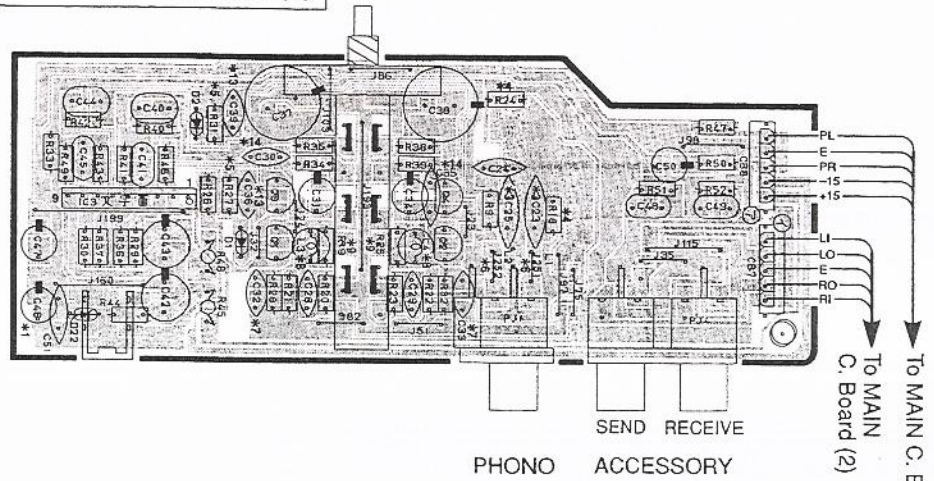

MAIN CIRCUIT BOARD (4)

MAIN CIRCUIT BOARD (4) (Chip Side)

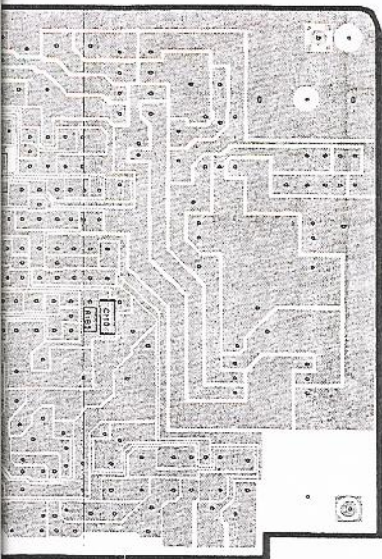
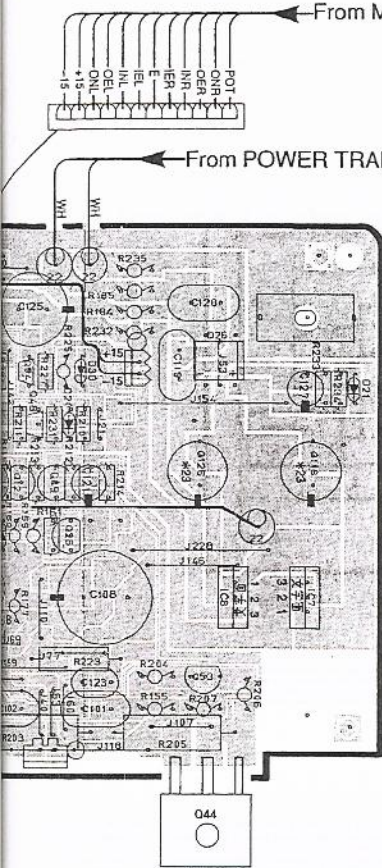
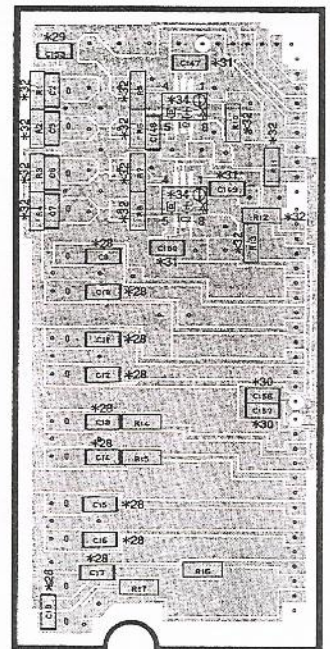
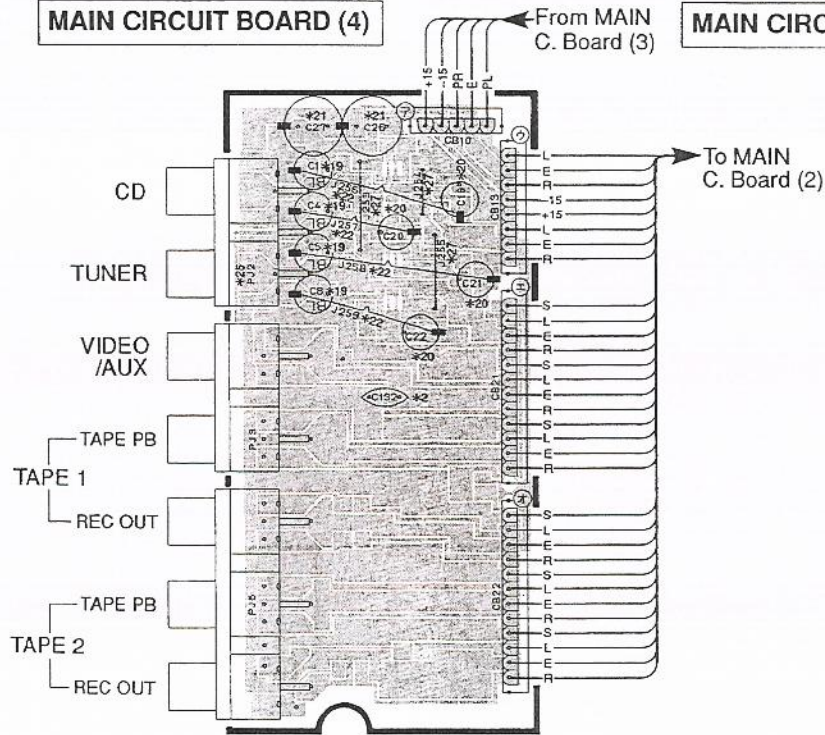

A

B

C

D

■ PRINTED CIRCUIT BOARD (Pattern side)

MAIN CIRCUIT BOARD (2)

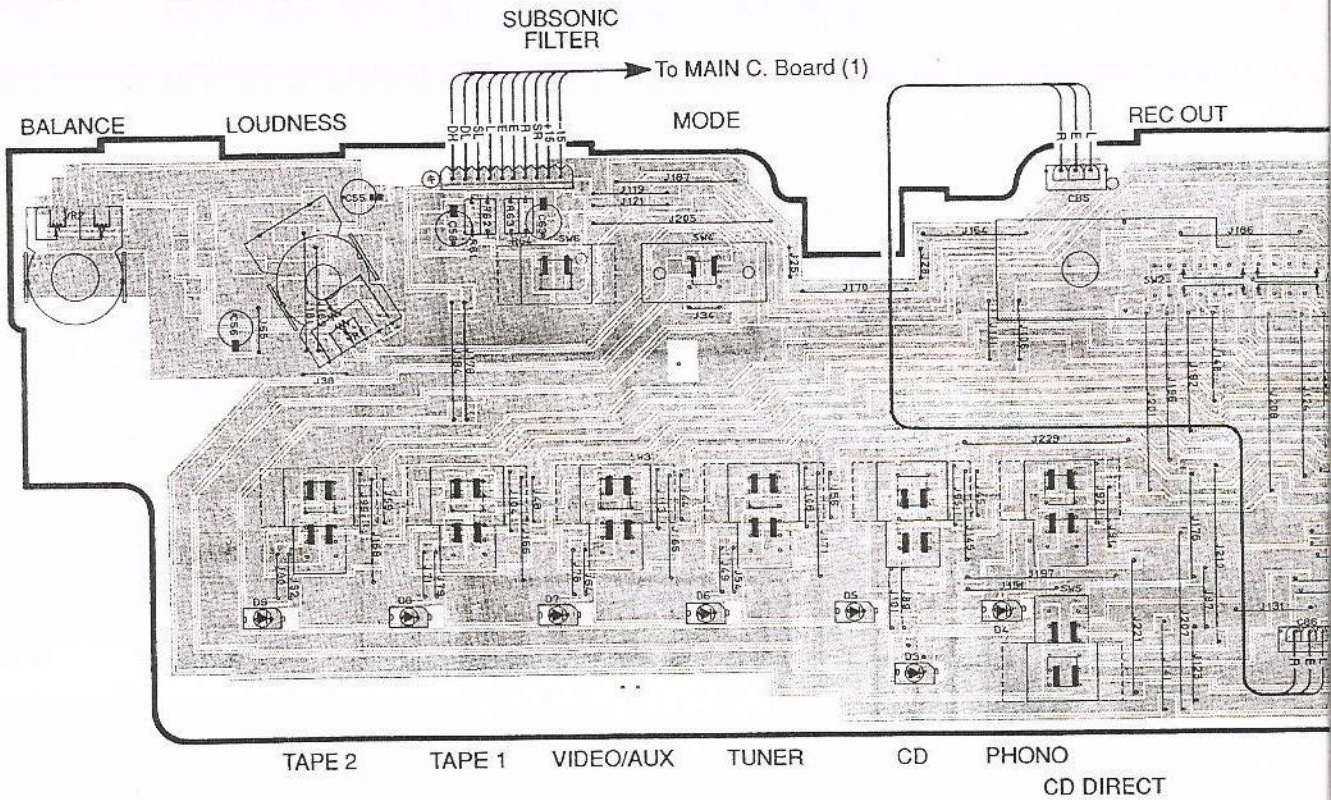

From MAIN C. Board

MAIN CIRCUIT BOARD (2) (Chip Side)

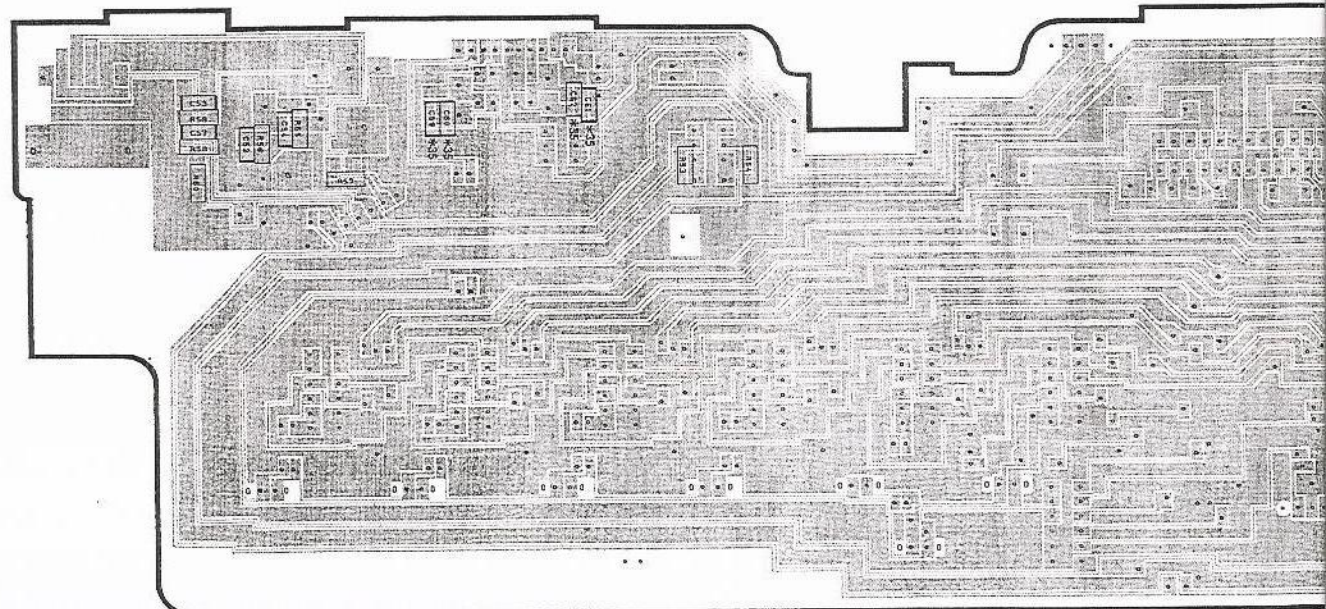

1

2

3

4

5

MAIN CIRCUIT BOARD (5)

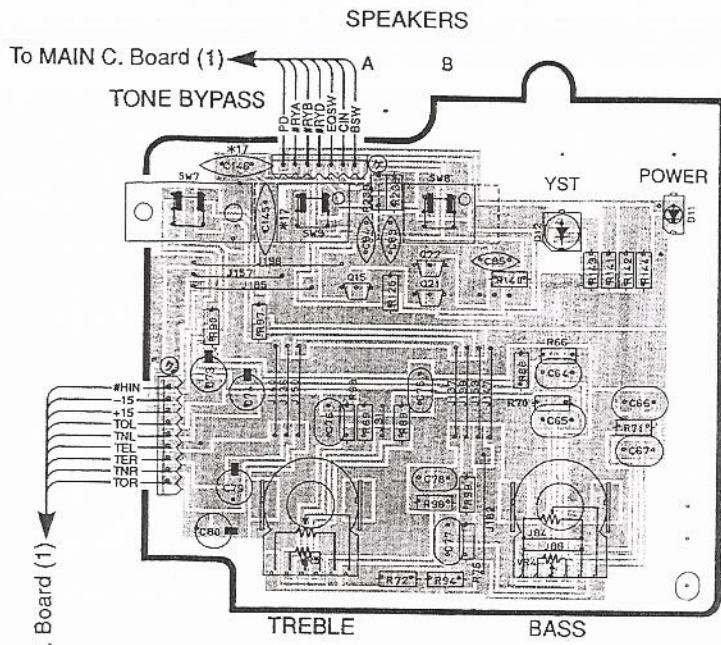

MAIN CIRCUIT BOARD (5) (Chip Side)

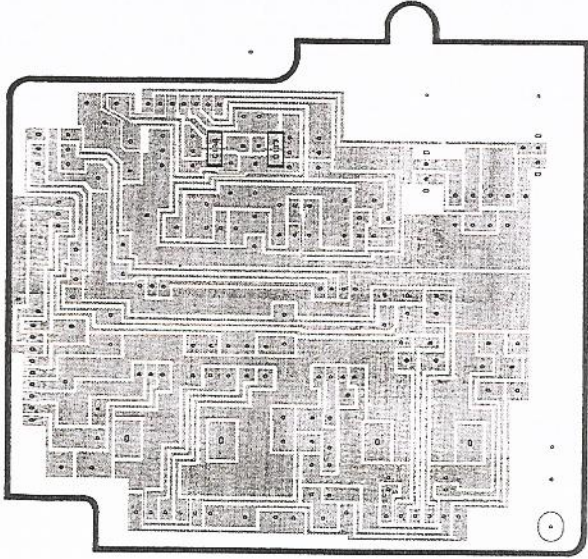

MAIN CIRCUIT BOARD (7)

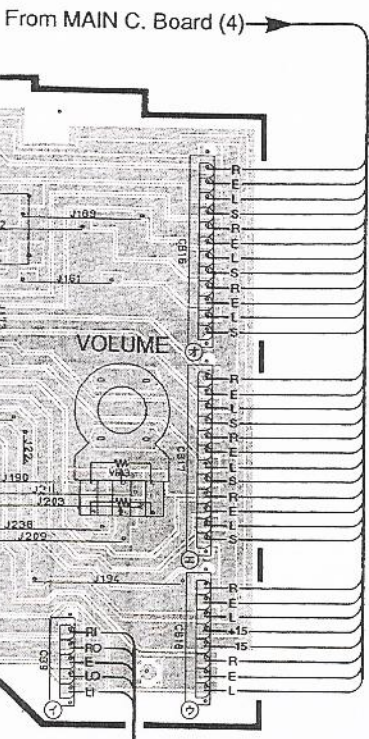
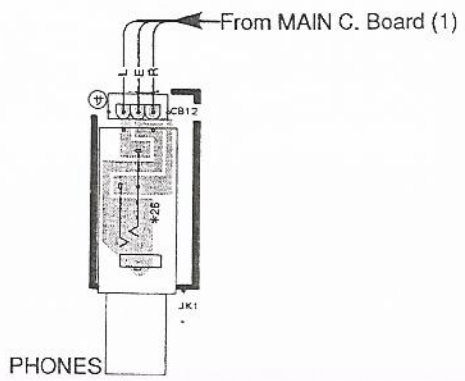

board (3) →

AX-640

A

B

C

D

AX-640

■ PRINTED CIRCUIT BOARD (Pattern side)

1

MAIN CIRCUIT BOARD (6)

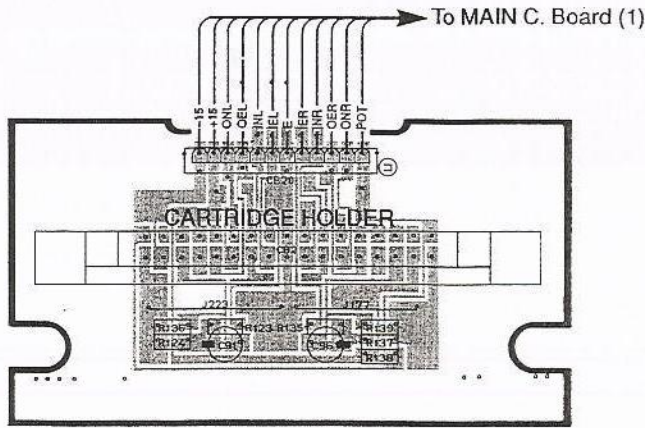

2

MAIN CIRCUIT BOARD (6) (Chip Side)

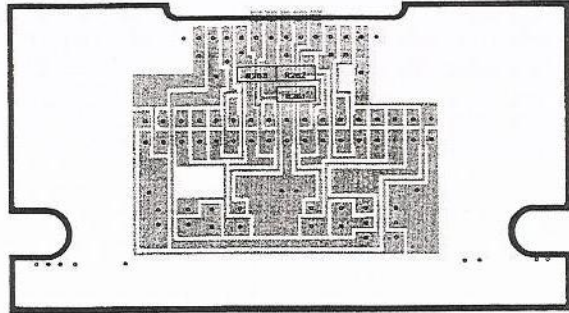

3

SUB CIRCUIT BOARD (1)

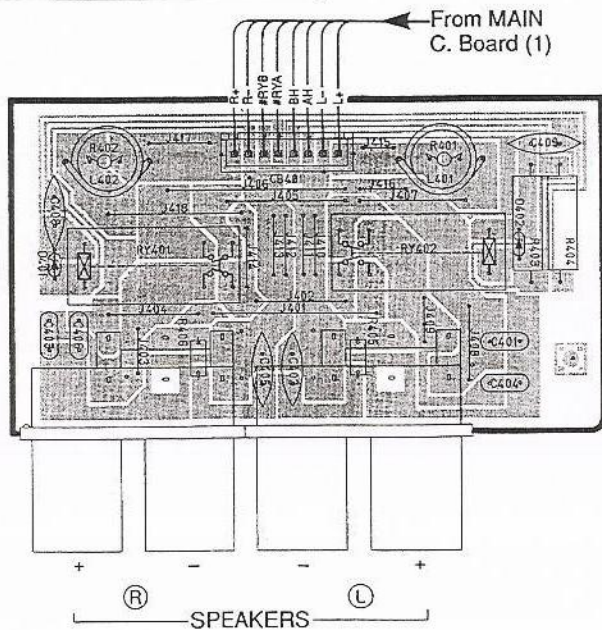

4

5

• J, U models

SUB CIRCUIT BOARD (3)

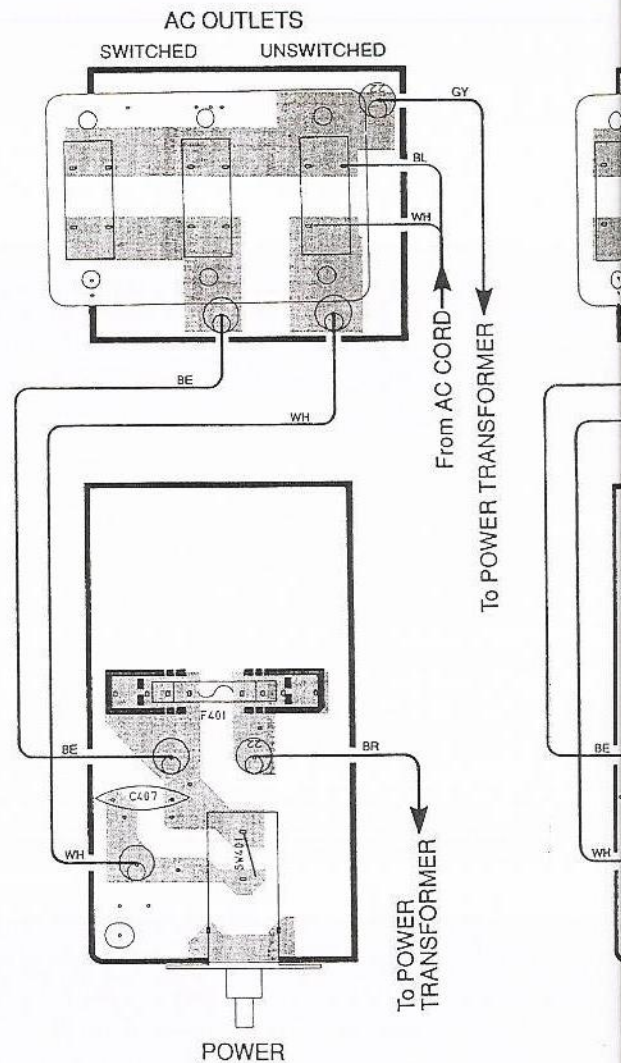

SUB CIRCUIT BOARD (2)

• R model

• C model

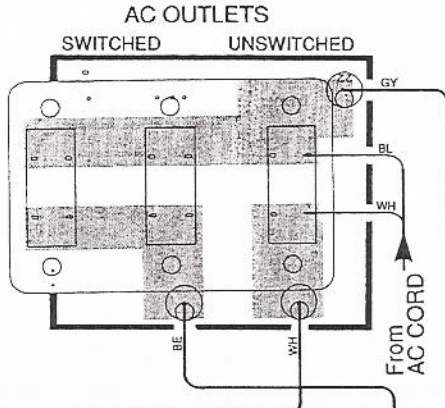
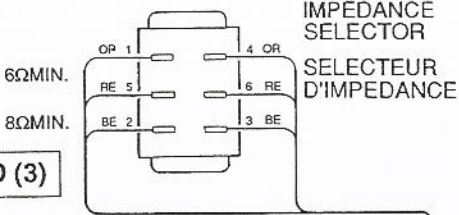

BOARD (3)

From AC CORD

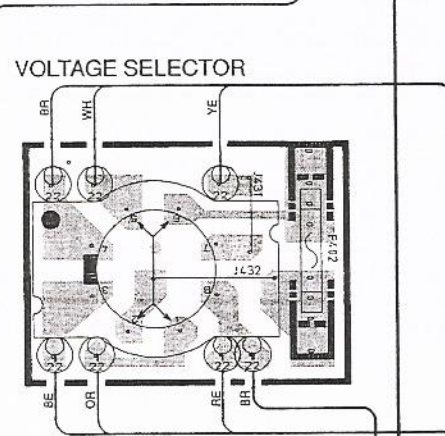

SUB CIRCUIT BOARD (4)

• A, B, G models

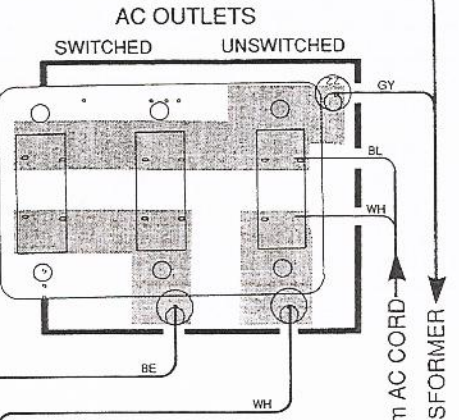
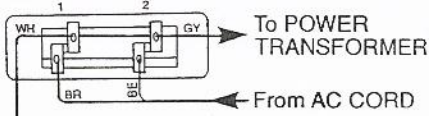

From AC CORD

To POWER TRANSFORMER

To POWER TRANSFORMER

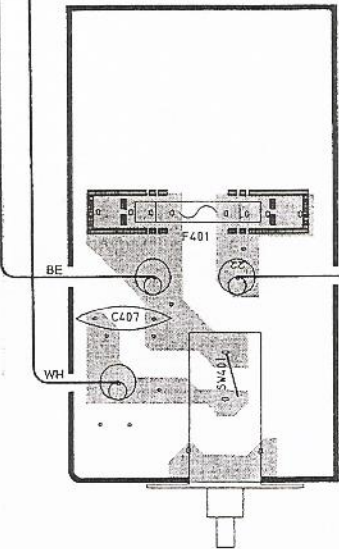

POWER

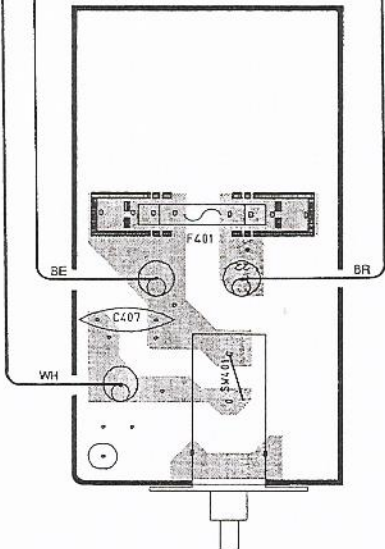

POWER

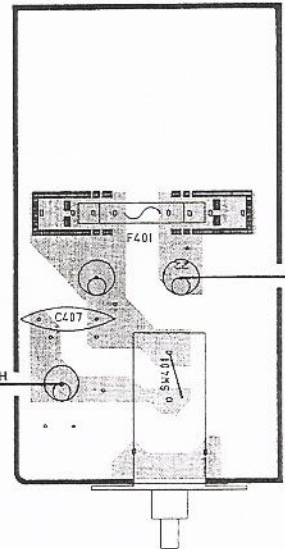

POWER

BOARD (2)

SUB CIRCUIT BOARD (2)

To POWER TRANSFORMER

PARTS LIST

■WARNING

Components having special characteristics are marked \triangle and must be replaced with parts having specifications equal to those originally installed.

● Carbon resistors (1/6W or 1/4W) are not included in the ELECTRICAL PARTS list. For the parts No. of the carbon resistor, refer to p.23.

■ ELECTRICAL PARTS

Ref. NO.	PART NO.	Description	部 品 名	Remarks	Markets	ランク
	VJ240000	MAIN CIRCUIT BOARD	メイン シート		RAB	
	VJ240100	MAIN CIRCUIT BOARD	メイン シート		C	
	VJ240200	MAIN CIRCUIT BOARD	メイン シート		G	
	VJ240300	MAIN CIRCUIT BOARD	メイン シート		J	
	FA153330	MYLAR FILM CAP	3300pF 50V	マイラーコン	C48,49	
	FA153510	MYLAR FILM CAP	5100pF 50V	マイラーコン	C75,78	
	FA154110	MYLAR FILM CAP	0.011uF 50V	マイラーコン	C41,45	
	FA154390	MYLAR FILM CAP	0.039uF 50V	マイラーコン	C40,44,76,77	
	FA154470	MYLAR FILM CAP	0.047uF 50V	マイラーコン	C64,67	
	FA155100	MYLAR FILM CAP	0.1uF 50V	マイラーコン	C122,123	
	FA155330	MYLAR FILM CAP	0.33uF 50V	マイラーコン	C65,66	
	UT465100	POLYPROPYLENE FILM CAP	0.1uF 100V	PPコン	C111,131	G
	UT454100	POLYPROPYLENE FILM CAP	0.01uF 100V	PPコン	C111,131	JCRAB
	UT454100	POLYPROPYLENE FILM CAP	0.01uF 100V	PPコン	C99~102,119,128	
	UT454100	POLYPROPYLENE FILM CAP	0.01uF 100V	PPコン	C130	G
	FG211100	CERAMIC CAP	10pF 50V	セラコン	C139,140	
	FG212100	CERAMIC CAP	100pF 50V	セラコン	C30,35	G
	FG212220	CERAMIC CAP	220pF 50V	セラコン	C23,25	G
	FG212220	CERAMIC CAP	220pF 50V	セラコン	C32,33	JCRAB
	FG212270	CERAMIC CAP	270pF 50V	セラコン	C32,33	G
	FG213100	CERAMIC CAP	1000pF 50V	セラコン	C83~85	
	FG213150	CERAMIC CAP	1500pF 50V	セラコン	C36,39	JCRAB
	FG713270	CERAMIC CAP	2700pF 50V	セラコン	C36,39	G
	FG213560	CERAMIC CAP	5600pF 50V	セラコン	C51	G
	FG244100	CERAMIC CAP	0.01uF 50V	セラコン	C28,29,154,155	
	FG244100	CERAMIC CAP	0.01uF 50V	セラコン	C132	G
	FG244470	CERAMIC CAP	0.047uF 50V	セラコン	C145,146	G
	UD111180	CHIP MULTILAYER CERAMIC CAP	18pF 50V	チップ積層セラコン	C105,110	
	UD111470	CHIP MULTILAYER CERAMIC CAP	47pF 50V	チップ積層セラコン	C68,71	
	UD111470	CHIP MULTILAYER CERAMIC CAP	47pF 50V	チップ積層セラコン	C147~150	G
	UD112100	CHIP MULTILAYER CERAMIC CAP	100pF 50V	チップ積層セラコン	C135,136	
	UD112100	CHIP MULTILAYER CERAMIC CAP	100pF 50V	チップ積層セラコン	C156,157	G
	UD112470	CHIP MULTILAYER CERAMIC CAP	470pF 50V	チップ積層セラコン	C2,3,6,7	
	UD112470	CHIP MULTILAYER CERAMIC CAP	470pF 50V	チップ積層セラコン	C9~18	G
	UD112680	CHIP MULTILAYER CERAMIC CAP	680pF 50V	チップ積層セラコン	C54,57	
	UD113100	CHIP MULTILAYER CERAMIC CAP	1000pF 50V	チップ積層セラコン	C88,89,94,95,97,104	
	UD114220	CHIP MULTILAYER CERAMIC CAP	0.022uF 50V	チップ積層セラコン	C52,53	
	UD114470	CHIP MULTILAYER CERAMIC CAP	0.047uF 50V	チップ積層セラコン	C59~62	CRABG
	UD114180	CHIP MULTILAYER CERAMIC CAP	0.018uF 50V	チップ積層セラコン	C59~62	J
	UD115100	CHIP MULTILAYER CERAMIC CAP	0.1uF 50V	チップ積層セラコン	C137,138	
	UD115100	CHIP MULTILAYER CERAMIC CAP	0.1uF 50V	チップ積層セラコン	C151~153	G
	VG288000	ELECTROLYTIC CAP	1000uF 16V	ケミコン	C26,27	CRABG
	Vi841000	ELECTROLYTIC CAP	100uF 6.3V	ケミコン	C116	
	Vi842200	ELECTROLYTIC CAP	10uF 16V	ケミコン	C74,79,92,141,142	
	Vi842300	ELECTROLYTIC CAP	22uF 16V	ケミコン	C47,50,73,80~82,124	
	Vi842400	ELECTROLYTIC CAP	33uF 16V	ケミコン	C46,91,96	
	Vi842500	ELECTROLYTIC CAP	47uF 16V	ケミコン	C72	
	Vi842800	ELECTROLYTIC CAP	330uF 16V	ケミコン	C42,43	
	Vi844500	ELECTROLYTIC CAP	0.1uF 50V	ケミコン	C55,58	
	Vi844900	ELECTROLYTIC CAP	1uF 50V	ケミコン	C121,127	

※New Parts (新規部品)

ランク : Japan only

AX-640

Ref. NO.	PART NO.	Description			部 品 名	Remarks	Markets	ランク
	Vi846000	ELECTROLYTIC CAP	22uF	63V	ケミコン	C98,103		
	UW819220	ELECTROLYTIC CAP	2200uF	6.3V	ケミコン	C37,38		
	UJ139100	ELECTROLYTIC CAP	1000uF	16V	ケミコン	C117,125		
	UW859100	ELECTROLYTIC CAP	1000uF	35V	ケミコン	C118,126	CRABG	
	UJ159220	ELECTROLYTIC CAP	2200uF	35V	ケミコン	C118,126	J	
	VE393700	ELECTROLYTIC CAP	47uF	16V	ケミコン	C112,115		
	VH620000	ELECTROLYTIC CAP	22uF	16V	ケミコン	C86,93,133,134,143,144		
	VH620100	ELECTROLYTIC CAP	33uF	16V	ケミコン	C87,90		
	VH620200	ELECTROLYTIC CAP	47uF	16V	ケミコン	C69,70		
	VH621700	ELECTROLYTIC CAP	1uF	50V	ケミコン	C58,63		
	VE017700	ELECTROLYTIC CAP	22uF	16V	ケミコン	C19~22	CRABG	
	VJ483500	ELECTROLYTIC CAP	470uF	80V	ケミコン	C107,108		
	FZ005420	ELECTROLYTIC CAP	10uF	25V	ケミコン	C1,4,5,8	CRABG	
	FZ005420	ELECTROLYTIC CAP	10uF	25V	ケミコン	C31,34		
	VH746400	ELECTROLYTIC CAP	12000uF	71V	ケミコン	C120,129	CRABG	
	VE442800	ELECTROLYTIC CAP	12000uF	71V	ケミコン	C120,129	J	
	FU351560	MICA CAP	56pF	500V	マイカコン	C106,109		
	FZ004130	SEMICONDUCTIVE CERAMIC CAP	0.1uF	25V	半導体セラコン	C24		
	VA983500	COIL	15uH		コイル	L1,2	G	
	VA983600	COIL	220uH		コイル	L3,4	G	
	HU574100	METAL FILM RESISTOR	10Ω	1/4W	金属被膜抵抗	R35,38		
	HU574100	METAL FILM RESISTOR	10Ω	1/4W	金属被膜抵抗	R18,24	JCRAB	
	HU594330	METAL FILM RESISTOR	33Ω	1/4W	金属被膜抵抗	R18,24	G	
	HU594220	METAL FILM RESISTOR	22Ω	1/4W	金属被膜抵抗	R208		
	HU594330	METAL FILM RESISTOR	33Ω	1/4W	金属被膜抵抗	R19,25	JCRAB	
	HU576220	METAL FILM RESISTOR	2.2KΩ	1/4W	金属被膜抵抗	R19,25 G		
	HU594470	METAL FILM RESISTOR	47Ω	1/4W	金属被膜抵抗	R86		
	HU595100	METAL FILM RESISTOR	100Ω	1/4W	金属被膜抵抗	R46,49,238,239		
	HU595100	METAL FILM RESISTOR	100Ω	1/4W	金属被膜抵抗	R27,31	JCRAB	
	HU575180	METAL FILM RESISTOR	180Ω	1/4W	金属被膜抵抗	R27,31	G	
	HU595150	METAL FILM RESISTOR	150Ω	1/4W	金属被膜抵抗	R34,39		
	HU575220	METAL FILM RESISTOR	220Ω	1/4W	金属被膜抵抗	R20,23,123,135		
	HU575270	METAL FILM RESISTOR	270Ω	1/4W	金属被膜抵抗	R148,161		
	HU575430	METAL FILM RESISTOR	430Ω	1/4W	金属被膜抵抗	R93,94		
	HU575470	METAL FILM RESISTOR	470Ω	1/4W	金属被膜抵抗	R47,50,61,64		
	HU596100	METAL FILM RESISTOR	1KΩ	1/4W	金属被膜抵抗	R141,142,144,264		
	HU576120	METAL FILM RESISTOR	1.2KΩ	1/4W	金属被膜抵抗	R44		
	HU576150	METAL FILM RESISTOR	1.5KΩ	1/4W	金属被膜抵抗	R70,71		
	HU576220	METAL FILM RESISTOR	2.2KΩ	1/4W	金属被膜抵抗	R89,98,116,117,121,133		
	HU576470	METAL FILM RESISTOR	4.7KΩ	1/4W	金属被膜抵抗	,234 R26,33		
	HU576680	METAL FILM RESISTOR	6.8KΩ	1/4W	金属被膜抵抗	R29,30,36,37,41,43		
	HU597100	METAL FILM RESISTOR	10KΩ	1/4W	金属被膜抵抗	R65,109,112,128,130, 131,212,256~258		
	HU577110	METAL FILM RESISTOR	11KΩ	1/4W	金属被膜抵抗	R66,75		
	HU577180	METAL FILM RESISTOR	18KΩ	1/4W	金属被膜抵抗	R138		
	HU577220	METAL FILM RESISTOR	22KΩ	1/4W	金属被膜抵抗	R140,210,233		
	HU577240	METAL FILM RESISTOR	24KΩ	1/4W	金属被膜抵抗	R244,255		
	HU577330	METAL FILM RESISTOR	33KΩ	1/4W	金属被膜抵抗	R147,162		

※New Parts (新規部品)

ランク : Japan only

AX-640

Ref. NO.	PART NO.	Description			部 品 名	Remarks	Markets	ランク
	HU577360	METAL FILM RESISTOR	36KΩ	1/4W	金属被膜抵抗	R88,99		
	HU577470	METAL FILM RESISTOR	47KΩ	1/4W	金属被膜抵抗	R51,52,108,110,111,231,237		
	HU577820	METAL FILM RESISTOR	82KΩ	1/4W	金属被膜抵抗	R28,32,40,42,151,158		
	HU598100	METAL FILM RESISTOR	100KΩ	1/4W	金属被膜抵抗	R124,125,136,137,139,		△
	HU578120	METAL FILM RESISTOR	120KΩ	1/4W	金属被膜抵抗	213,214		
	HU578150	METAL FILM RESISTOR	150KΩ	1/4W	金属被膜抵抗	R21,22		
	HU598220	METAL FILM RESISTOR	220KΩ	1/4W	金属被膜抵抗	R211		
	HU578470	METAL FILM RESISTOR	470KΩ	1/4W	金属被膜抵抗	R143,145,146,228		
	RA255220	CHIP RESISTOR	220Ω	1/8W	チップ抵抗	R87,209		
	RA255470	CHIP RESISTOR	470Ω	1/8W	チップ抵抗	R14~17		
	RA256200	CHIP RESISTOR	2KΩ	1/8W	チップ抵抗	R154,157		
	RA256330	CHIP RESISTOR	3.3KΩ	1/8W	チップ抵抗	R78,84		
	RA256470	CHIP RESISTOR	4.7KΩ	1/8W	チップ抵抗	R100,107		
	RA256560	CHIP RESISTOR	5.6KΩ	1/8W	チップ抵抗	R53,54		
	RA256750	CHIP RESISTOR	7.5KΩ	1/8W	チップ抵抗	R240,241		
	RA256820	CHIP RESISTOR	8.2KΩ	1/8W	チップ抵抗	R103,104		
	RA257100	CHIP RESISTOR	10KΩ	1/8W	チップ抵抗	R56,59		
	RA257180	CHIP RESISTOR	18KΩ	1/8W	チップ抵抗	R79,82,102,105,169,171		
	RA257270	CHIP RESISTOR	27KΩ	1/8W	チップ抵抗	173,174,176,179		
	RA257470	CHIP RESISTOR	47KΩ	1/8W	チップ抵抗	R57,58		
	RA258100	CHIP RESISTOR	100KΩ	1/8W	チップ抵抗	R55,60		
	RA258100	CHIP RESISTOR	100KΩ	1/8W	チップ抵抗	R118,134		
	RA258120	CHIP RESISTOR	120KΩ	1/8W	チップ抵抗	R1~8,10~13	CRABG	
	RA258180	CHIP RESISTOR	180KΩ	1/8W	チップ抵抗	R80,262,263		
	RA258220	CHIP RESISTOR	220KΩ	1/8W	チップ抵抗	R261		
	RA258330	CHIP RESISTOR	330KΩ	1/8W	チップ抵抗	R76,85		
	RA258470	CHIP RESISTOR	470KΩ	1/8W	チップ抵抗	R81,219,220		
	VF703900	CHIP RESISTOR	1KΩ	1/16W	チップ抵抗	R77,83,101,106		
	VF376600	CHIP RESISTOR	2.2KΩ	1/16W	チップ抵抗	R229,230		
	VH256900	CHIP RESISTOR	2.4KΩ	1/16W	チップ抵抗	R195,199		
	VH257000	CHIP RESISTOR	82KΩ	1/16W	チップ抵抗	R115,132		
	HV453220	FLAME PROOF CARBON RESISTOR	2.2Ω	1/4W	不燃化カーボン抵抗	R194,198	G	△
	HV453220	FLAME PROOF CARBON RESISTOR	2.2Ω	1/4W	不燃化カーボン抵抗	R259,260	G	△
	HV453470	FLAME PROOF CARBON RESISTOR	4.7Ω	1/4W	不燃化カーボン抵抗	R265		△
	HV454470	FLAME PROOF CARBON RESISTOR	47Ω	1/4W	不燃化カーボン抵抗	R152,153,155,156,184,185,187,192,201,207,232,235		△
	HV454560	FLAME PROOF CARBON RESISTOR	56Ω	1/4W	不燃化カーボン抵抗	R45,48,168,170,177,178		△
	HV455150	FLAME PROOF CARBON RESISTOR	150Ω	1/4W	不燃化カーボン抵抗	R126,129		△
	HV455220	FLAME PROOF CARBON RESISTOR	220Ω	1/4W	不燃化カーボン抵抗	R163,183		△
	HV455330	FLAME PROOF CARBON RESISTOR	330Ω	1/4W	不燃化カーボン抵抗	R149,150,159,160		△
	HV455560	FLAME PROOF CARBON RESISTOR	560Ω	1/4W	不燃化カーボン抵抗	R190,202		△
	HV456100	FLAME PROOF CARBON RESISTOR	1KΩ	1/4W	不燃化カーボン抵抗	R225		△
	HV456120	FLAME PROOF CARBON RESISTOR	1.2KΩ	1/4W	不燃化カーボン抵抗	R189,204		△
	HV456220	FLAME PROOF CARBON RESISTOR	2.2KΩ	1/4W	不燃化カーボン抵抗	R166,181		△
	HV456470	FLAME PROOF CARBON RESISTOR	4.7KΩ	1/4W	不燃化カーボン抵抗	R164,182		△
	VD952400	METAL OXIDE RESISTOR	0.22Ω	3W	酸化金属被膜抵抗	R186,206		△
						R188,191,203,205		△

※New Parts (新規部品)

ランク : Japan only

Ref. NO.	PART NO.	Description	部 品 名	Remarks	Markets	ランク
	HL313470	METAL OXIDE RESISTOR	4.7Ω 1W	酸化金属被膜抵抗	R216,223	
	HL315120	METAL OXIDE RESISTOR	120Ω 1W	酸化金属被膜抵抗	R242,243	
	VG529200	WIRE WOUND RESISTOR	0.2Ω 3W	セメント抵抗	R196,197	
	XC011001	IC	NJM5532M	IC	IC5	J
	XF291A00	IC	uPC4570G2-T1	IC	IC5	CRABG
	iG077410	IC	NJM4556S-A	IC	IC9	
	XB247301	IC	uPC4570HA	IC	IC3	
	XC632001	IC	NJM5532SD	IC	IC4	
	XG504A00	IC	BA4558F	IC	IC6	
	XF291A00	IC	uPC4570G2	IC	IC1,2	
	XE584A00	IC	NJM78M15FA	IC	IC7	
	XG505A00	IC	NJM79M15FA	IC	IC8	
	VC237800	ROTARY SWITCH	SRRZU4	ロータリーSW	SW2	
	VC176700	PUSH SWITCH	4-2	プッシュSW	SW5	
	VC245500	PUSH SWITCH	2-2 SPEC12036B	プッシュSW	SW6,8,9	
	VC369900	PUSH SWITCH	6-2 SPUF19	プッシュSW	SW1	
	VD156300	PUSH SWITCH	2-2 SPEC12	プッシュSW	SW4	
	VH584000	PUSH SWITCH	2-2 SPEC12	プッシュSW	SW7	
	VC237700	PUSH SWITCH	4-2 SPEC616	プッシュSW	SW3	
	LB202290	PIN JACK	2P T5856-A	ピンジャック	PJ1	
	LB401030	PIN JACK	4P T5857-A	ピンジャック	PJ3,4	
	LB401040	PIN JACK	4P	ピンジャック	PJ2	CRABG
	VJ394700	PIN JACK	4P	ピンジャック	PJ2	J
	LB606090	PIN JACK	6P T5916-A	ピンジャック	PJ5	
	LB301720	PHONES JACK		ヘッドホンジャック	JK1	CRABG
	VA316300	PHONES JACK		ヘッドホンジャック	JK1	J
	VG529900	SOCKET	34P	コネクターソケット	CB2	
	VB861200	PRE-SET POTENTIOMETER	B2.2KΩ	半固定VR	VR7,8	
	VC237100	POTENTIOMETER	MN250KΩ	二連ロータリーVR	VR2	
	VC237200	POTENTIOMETER	80KΩ	二連ロータリーVR	VR5	
	VC237300	POTENTIOMETER	100KΩ	二連ロータリーVR	VR4	
	VJ268300	POTENTIOMETER	Y60KΩ	二連ロータリーVR	VR3	
	VC297400	POTENTIOMETER	300KΩ	二連ロータリーVR	VR1	
	iA111510	TRANSISTOR	2SA1115 E,F	トランジスタ	Q9,15,17,18,54	
	iA097000	TRANSISTOR	2SA970 GR,BL	トランジスタ	Q1~4,49,52	
	iA114500	TRANSISTOR	2SA1145 O,Y	トランジスタ	Q27,34	
	iC224000	TRANSISTOR	2SC2240 GR,BL	トランジスタ	Q24,25,28,33,45,51,53	
	iC260310	TRANSISTOR	2SC2603 E,F	トランジスタ	Q5,8,46~48	
	iC270500	TRANSISTOR	2SC2705 O,Y	トランジスタ	Q29,32	
	iC287800	TRANSISTOR	2SC2878 A,B	トランジスタ	Q6,7,11,12,19,20,30,31	
	iX608510	TRANSISTOR	2SA1358	トランジスタ	Q35,36	
	iX603590	TRANSISTOR	2SC3421	トランジスタ	Q39,41	
	iA134900	TRANSISTOR	2SA1349 GR,BL	トランジスタ	Q37,43	
	iE101280	FET	2SK105 F,H	FET	Q23,26	
	VG721700	DIGITAL TRANSISTOR	DTA144ES	デジトラ	Q10	
	VG722000	DIGITAL TRANSISTOR	DTC144ES	デジトラ	Q21	
	VH257100	DIGITAL TRANSISTOR	DTA124ES	デジトラ	Q14	
	iF004600	DIODE	1SS133	ダイオード	Q22	
	iH000870	DIODE BRIDGE	4D4B41	ダイオードブリッジ	D1,2,13~21,28,29	
					D27	

*New Parts (新規部品)

ランク : Japan only

AX-640

Ref. NO.	PART NO.	Description	部 品 名	Remarks	Markets	ランク
	VE367900	DIODE BRIDGE	DF02M	ダイオードブリッジ	D26	
	VG436200	ZENER DIODE	MTZJ3.6A	ツェナーダイオード	D30	
	VG437700	ZENER DIODE	MTZJ5.6B	ツェナーダイオード	D23	
	VG438000	ZENER DIODE	MTZJ6.2B	ツェナーダイオード	D22	
	VH293600	LED	SLR-55DC3H (YEL)	L E D	D12	
	Vi013500	LED	SLR-34DC3H4 (YEL)	L E D	D4~9	
	VJ290000	LED	SLR-34VC3H4 (RED)	L E D	D3, 11	
	RA250000	CHIP RESISTOR	0Ω 1/8W	チップ抵抗	J1~9	
	VH583900	SLIDE SWITCH		スライドSW		C
	CB069250	BINDING TIE	BK-1	束線止め		
	VA821500	RADIATOR		ラジエーター		C
	BB069510	GROUND PLATE		ランド金具		
	BB071360	TERMINAL, SCREW	8.3x13	ネジ端子		
	VA119100	HEAT SINK		ヒートシンク		
	EZ001350	CUP SCREW	3x14 FCRN3-BL	カップネジ		C
	CB088510	STOPPER		ストッパー		
	VH265600	SUB CIRCUIT BOARD		サブシート		J
	VH265700	SUB CIRCUIT BOARD		サブシート		C
	VH265800	SUB CIRCUIT BOARD		サブシート		R
	VH265900	SUB CIRCUIT BOARD		サブシート		AB
	VH266000	SUB CIRCUIT BOARD		サブシート		G
	F1324100	CERAMIC CAP	0.01uF 250V	スパークキラーコン	C407	J
	Fi414100	CERAMIC CAP	0.01uF	スパークキラーコン	C407	CRABG
	FG244220	CERAMIC CAP	0.022uF 50V	セラコン	C402, 405	G
	FG244470	CERAMIC CAP	0.047uF 50V	セラコン	C408, 409	G
	FA154100	HYLAR FILM CAP	0.01uF 50V	マイラーコン	C401, 403, 404, 406	G
	GD900470	COIL	1.5uH	クウシンコイル	L401, 402	
	HL326180	METAL OXIDE RESISTOR	1.8KΩ 2W	酸化金属被膜抵抗	R403, 404	
	HV454100	FLAME PROOF CARBON RESISTOR	10Ω 1/4W	不燃化カーボン抵抗	R401, 402	
	VG442500	ZENER DIODE	MTZJ24B	ツェナーダイオード	D401, 402	
	KC002020	RELAY	DH24D2	リレー	RY401	
	VC278600	RELAY	DC G5R-2232P	リレー	RY402	
	VC409700	PUSH SWITCH	ESB-82101V-F	プッシュSW	SW401	
	KB000370	FUSE	250V 3.5A	ヒューズ	F402	R
	KB001300	FUSE	7.0A 250V	ヒューズ	F401	JR
	KB001520	FUSE	7.0A 125V	ヒューズ	F401	C
	KB002980	FUSE	T2.5A 250V	ヒューズ	F401	ABG
	LB918080	BASE PIN	XH 8P	ベースツキボスト	CB401	
	VA961800	VOLTAGE SELECTOR		電圧切替器		R
	LB201060	FUSE HOLDER PIN	YSH403T	ヒューズホルダーピン		ABG
	LB201970	FUSE HOLDER PIN		ヒューズホルダーピン		JCR
	LB608170	AC OUTLET	M7032D	ACアウトレット		JCR
	VC313700	SPEAKER TERMINAL		スピーカターミナル		CRAB
	VC720900	SPEAKER TERMINAL		スピーカターミナル		G
	VJ453700	SPEAKER TERMINAL		スピーカターミナル		J

*New Parts (新規部品)

ランク : Japan only

AX-640

A

B

C

D

AX-640

EXPLODED VIEW

1

2

3

4

5

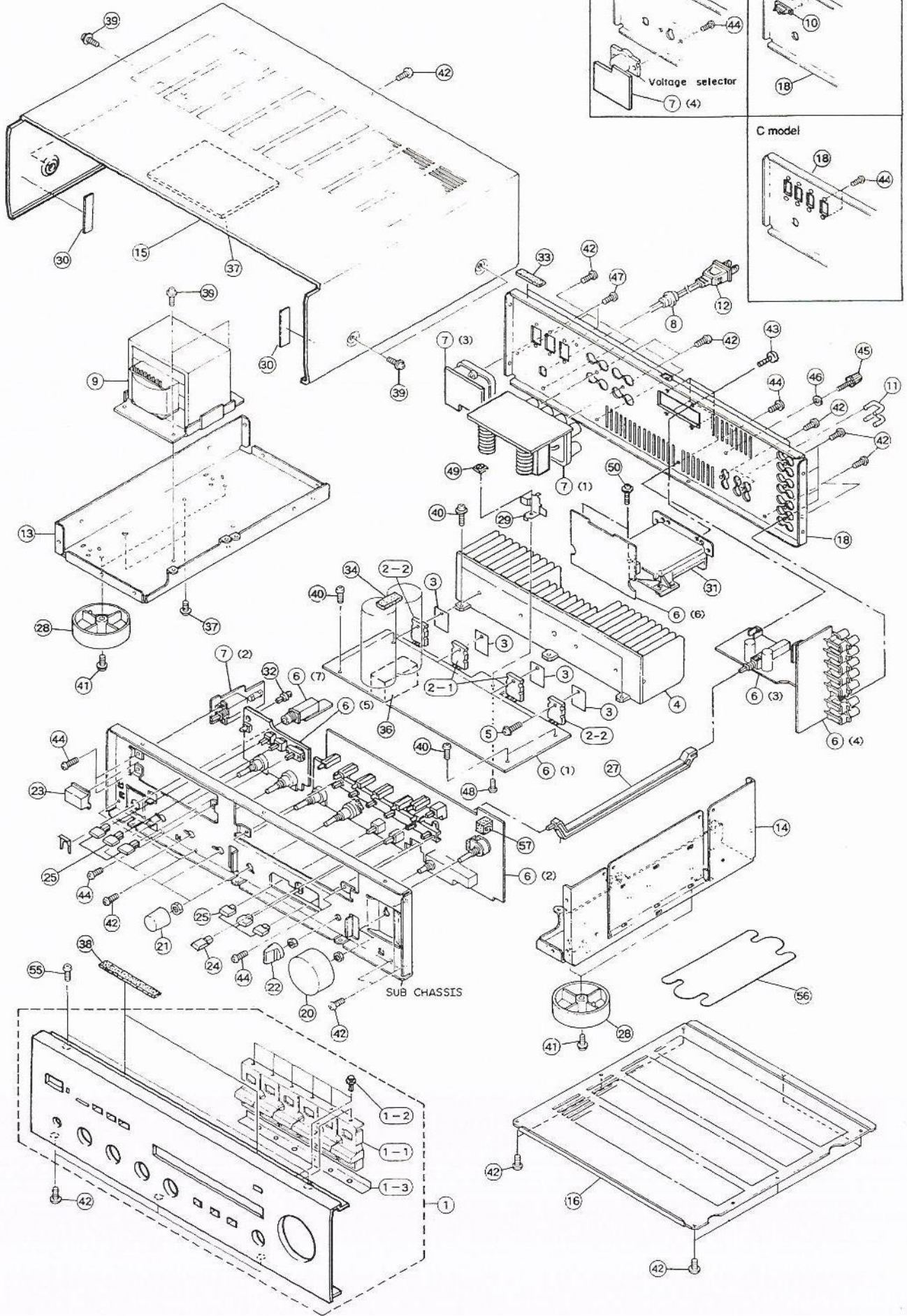

MECHANISM PARTS

Ref. NO.	PART NO.	Description	部品名		Remarks	Markets	ランク
1	VJ239800	PANEL UNIT			BL		
1	VJ239900	PANEL UNIT			T		
1-1	VJ234900	BUTTON			BL		
1-1	VJ235200	BUTTON			T		
1-2	CB068880	PLASTIC RIVET			BL		
1-3	VJ556400	SPACER					
2-1	iX608110	TRANSISTOR	2SA1301 R.0		トランジスタ		
2-2	iX608120	TRANSISTOR	2SC3280 R.0		トランジスタ		
3	VC397200	SHEET	D-290		デンカシート		
4	VH192500	RADIATOR			ラジエター		
5	EK330020	BW HEAD TAPPING SCREW	3x14	FCRM3-BL	BWヘッドタッピングネジ		
6	VJ240000	MAIN CIRCUIT BOARD			メインシート	RAB	
6	VJ240100	MAIN CIRCUIT BOARD			メインシート	C	
6	VJ240200	MAIN CIRCUIT BOARD			メインシート	G	
6	VJ240300	MAIN CIRCUIT BOARD			メインシート	J	
7	VH265600	SUB CIRCUIT BOARD			サブシート	J	
7	VH265700	SUB CIRCUIT BOARD			サブシート	C	
7	VH265800	SUB CIRCUIT BOARD			サブシート	R	
7	VH265900	SUB CIRCUIT BOARD			サブシート	AB	
7	VH266000	SUB CIRCUIT BOARD			サブシート	G	
8	CB620190	CORD STOPPER	CH-22B		コードストッパー	RABG	
8	CB620200	CORD STOPPER	CH-22C		コードストッパー	JC	
9	XH792A00	POWER TRANSFORMER			電源トランス	J	
9	XG094A00	POWER TRANSFORMER			電源トランス	C	
9	XG095A00	POWER TRANSFORMER			電源トランス	R	
9	XG096A00	POWER TRANSFORMER			電源トランス	AB	
9	XG097A00	POWER TRANSFORMER			電源トランス	G	
10	VD614100	TERMINAL	2P	ST8VP-B	中継端子台	ABG	
11	LB101110	SHORT PLUG			ショートプラグ	CRABG	
11	LB101890	SHORT PLUG			ショートプラグ	J	
12	HG001210	POWER CORD	15A	125V 2m	電源コード	J	
12	HG002220	POWER CORD	10A	125V	電源コード	C	
12	VE371000	POWER CORD	6A	250V 2m	電源コード	R	
12	HG002310	POWER CORD	7.5A	250V	電源コード	A	
12	HG002330	POWER CORD	6A	300V	電源コード	B	
12	HG002320	POWER CORD	2.5A	250V	電源コード	G	
13	AA631260	FRAME, SIDE L			フレームサイド L		
14	AA631270	FRAME, SIDE R			フレームサイド R		
15	VJ209000	TOP COVER			トップカバー	BL	JCRA
15	VJ209100	TOP COVER			トップカバー	T	JCRA
15	VJ234000	TOP COVER ASS'Y			トップカバーASSY	BL	BG
15	VJ234100	TOP COVER ASS'Y			トップカバーASSY	T	BG
16	AA631320	BOTTOM COVER			ボトムカバー		
18	VJ209400	REAR PANEL			リヤパネル		J
18	VJ209600	REAR PANEL			リヤパネル		C
18	VJ209700	REAR PANEL			リヤパネル		R
18	VJ209800	REAR PANEL			リヤパネル		AB
18	VJ209900	REAR PANEL			リヤパネル		G
20	VH815400	KNOB	VR		ノブ	BL	
20	VH815500	KNOB	VR		ノブ	T	

*New Parts (新規部品)

ランク : Japan only

Ref. NO.	PART NO.	Description	部 品 名	Remarks	Markets	ランク
21	VH889200	KNOB	TONE, BAL, LOUD.	ノブ	BL	
21	VH889300	KNOB	TONE, BAL, LOUD.	ノブ	T	
22	VJ211700	KNOB	REC OUT	ノブ	BL	
22	VJ211800	KNOB	REC OUT	ノブ	T	
23	VH841900	BUTTON	POWER	ボタン	BL	
23	VH842000	BUTTON	POWER	ボタン	T	
24	VJ235000	BUTTON	CD DIR.	ボタン	BL	
24	VJ235100	BUTTON	CD DIR.	ボタン	T	
25	VH816000	BUTTON	SP.,TONE BY.	ボタン	BL	
25	VH816100	BUTTON	SP.,TONE BY.	ボタン	T	
27	CB659320	ROD	S	ロッド		J
28	Vi615200	LEG		レッグ	BL	CRABG
28	CB660950	LEG		レッグ	T	CRABG
28	Vi175700	LEG		レッグ		
29	BB070960	PUSHER, TR		TR プッシャー		
30	VF661800	PAD		パッド		
31	Vi176100	BOX ASS'Y		ボックスASSY		
32	CB099600	PLASTIC RIVET		プラスチックリベット		
33	VJ212100	DAMPER	3.5/8/28	ダンパー		J
34	VJ314500	CUSHION		クッション		
34	VJ234600	CUSHION		クッション		CRA
34	VJ314400	CUSHION		クッション		BG
35	VH897400	SHIELD PLATE		シールドプレート		CBG
36	VH604700	CUSHION		クッション		J
37	VF222600	DAMPER		ダンパー		J
38	VJ477700	CUSHION		クッション		J
39	EX601080	CUP S-TITE SCREW	4x8-10 FCRM3-BL	カップSタイトネジ	BL	
39	EX601060	BW HEAD S-TITE SCREW	4x8-10 FNM3-BL	BWヘッドSタイトネジ	T	
40	EX600700	BW HEAD TAPPING SCREW	3x8 FCM3	BWヘッドタッピングネジ		
41	EX600090	CUP B-TITE SCREW	3x8 FCRM3-BL	カップBタイトネジ		
42	EN340020	BIND HEAD BONDING TAP. SCREW	3x8 FCRM3-BL	ボンディングBタイトネジ		
43	Ei340086	BIND HEAD TAPPING SCREW	4x8 FCRM3-BL	バインドBタイトネジ	PACK	
44	ED330066	BIND HEAD SCREW	3x6 FCRM3-BL	バインド小ネジ	PACK	
45	AA627310	GROUND TERMINAL		GNDターミナル		
46	EV901360	PLAIN WASHER	3.6x10x0.8 FNM3-3G	平座金みがき丸		
47	Ei330086	BIND HEAD TAPPING SCREW	3x8 FCRM3-BL	バインドBタイトネジ		JCR
48	ED030086	BIND HEAD S-TITE SCREW	3x8 ZMC2-Y	バインドSタイトネジ		
49	VF452300	PUSH NUT	SPN-2.6	軸用プッシュナット		
50	Ei330146	BIND HEAD TAPPING SCREW	3x14 FCRM3-BL	バインドBタイトネジ		
55	Ei330066	BIND HEAD B-TITE SCREW	3x6 FCRM3-BL	バインドBタイトネジ	PACK	
56	VJ596900	SHEET/PROTECT		保護シート		
57	VJ234600	CUSHION		クッション		
	CB069250	BINDING TIE	BK-1	束線止め		

*New Parts (新規部品)

ランク : Japan only

Parts List for Carbon Resistors

Markets
 RA
 BG
 CR
 Japan only

Value	1/4W Type Part No.	1/6W Type Part No.	Value	1/4W Type Part No.	1/6W Type Part No.
1.0Ω	HJ35 3100	※	12KΩ	HJ35 7120	HF85 7120
1.8Ω	HJ35 3180	※	15Ω	HJ35 7150	HF85 7150
2.2Ω	HJ35 3220	HF85 3220	18Ω	HJ35 7180	HF85 7180
3.3Ω	HJ35 3330	HF85 3330	22Ω	HJ35 7220	HF85 7220
4.7Ω	HJ35 3470	HF85 3470	27Ω	HJ35 7270	HF85 7270
5.6Ω	HJ35 3560	HF85 3560	33Ω	HJ35 7330	HF85 7330
10Ω	HJ35 4100	HF85 4100	39Ω	HJ35 7390	HF85 7390
15Ω	HJ35 4150	HF85 4150	47Ω	HJ35 7470	HF85 7470
22Ω	HJ35 4220	HF85 4220	56Ω	HJ35 7560	HF85 7560
27Ω	HJ35 4270	HF85 4270	68Ω	HJ35 7680	HF85 7680
33Ω	HJ35 4330	HF85 4330	82Ω	HJ35 7820	HF85 7820
39Ω	HJ35 4390	HF85 4390	91Ω	HJ35 7910	HF85 7910
47Ω	HJ35 4470	HF85 4470	100Ω	HJ35 8100	HF85 8100
56Ω	HJ35 4560	HF85 4560	120Ω	HJ35 8120	HF85 8120
68Ω	HJ35 4680	HF85 4680	150Ω	HJ35 8150	HF85 8150
82Ω	HJ35 4820	HF85 4820	180Ω	HJ35 8180	HF85 8180
100Ω	HJ35 5100	HF85 5100	220Ω	HJ35 8220	HF85 8220
110Ω	HJ35 5110	HF85 5100	270Ω	HJ35 8270	HF85 8270
120Ω	HJ35 5120	HF85 5120	330Ω	HJ35 8330	HF85 8330
150Ω	HJ35 5150	HF85 5150	390Ω	HJ35 8390	HF85 8390
160Ω	HJ35 5160	※	470Ω	HJ35 8470	HF85 8470
180Ω	HJ35 5180	HF85 5180	560Ω	HJ35 8560	HF85 8560
220Ω	HJ35 5220	HF85 5220	680Ω	HJ35 8680	HF85 8680
270Ω	HJ35 5270	HF85 5270	820Ω	HJ35 8820	HF85 8820
330Ω	HJ35 5330	HF85 5330	1.0MΩ	HJ35 9100	HF85 9100
390Ω	HJ35 5390	HF85 5390	1.2Ω	HJ35 9120	※
470Ω	HJ35 5470	HF85 5470	1.5Ω	HJ35 9150	HF85 9150
510Ω	※	HF85 5510	1.8Ω	HJ35 9180	HF85 9180
560Ω	HJ35 5560	HF85 5560	2.2Ω	HJ35 9220	HF85 9220
680Ω	HJ35 5680	HF85 5680	3.3Ω	HJ35 9330	HF85 9330
820Ω	HJ35 5820	HF85 5820	3.9Ω	HJ35 9390	※
910Ω	HJ35 5910	HF85 5910	4.7Ω	HJ35 9470	※
1.0KΩ	HJ35 6100	HF85 6100			
1.2Ω	HJ35 6120	HF85 6120			
1.5Ω	HJ35 6150	HF85 6150			
1.8Ω	HJ35 6180	HF85 6180			
2.0Ω	HJ35 6200	HF85 6200			
2.2Ω	HJ35 6220	HF85 6220			
2.4Ω	HJ35 6240	HF85 6240			
2.7Ω	HJ35 6270	HF85 6270			
3.0Ω	HJ35 6300	HF85 6300			
3.3Ω	HJ35 6330	HF85 6330			
3.6Ω	HJ35 6360	HF85 6360			
3.9Ω	HJ35 6390	HF85 6390			
4.7Ω	HJ35 6470	HF85 6470			
5.1Ω	HJ35 6510	HF85 6510			
5.6Ω	HJ35 6560	HF85 6560			
6.8Ω	HJ35 6680	HF85 6680			
8.2Ω	HJ35 6820	HF85 6820			
9.1Ω	HJ35 6910	HF85 6910			
10Ω	HJ35 7100	HF85 7100			

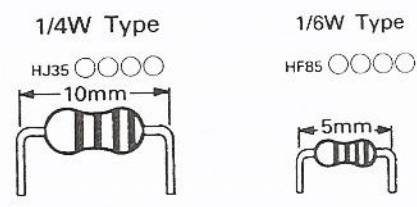

AX-640

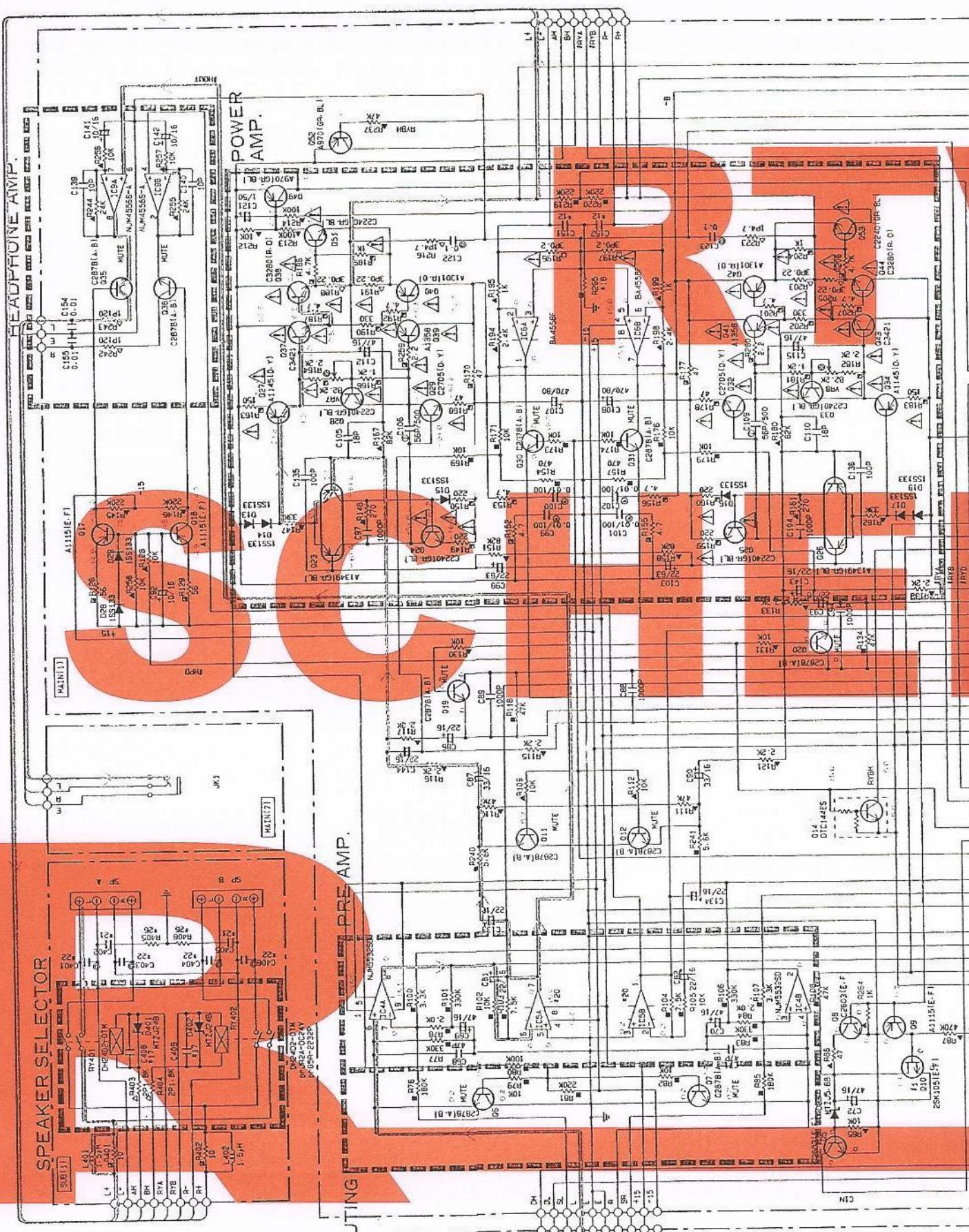

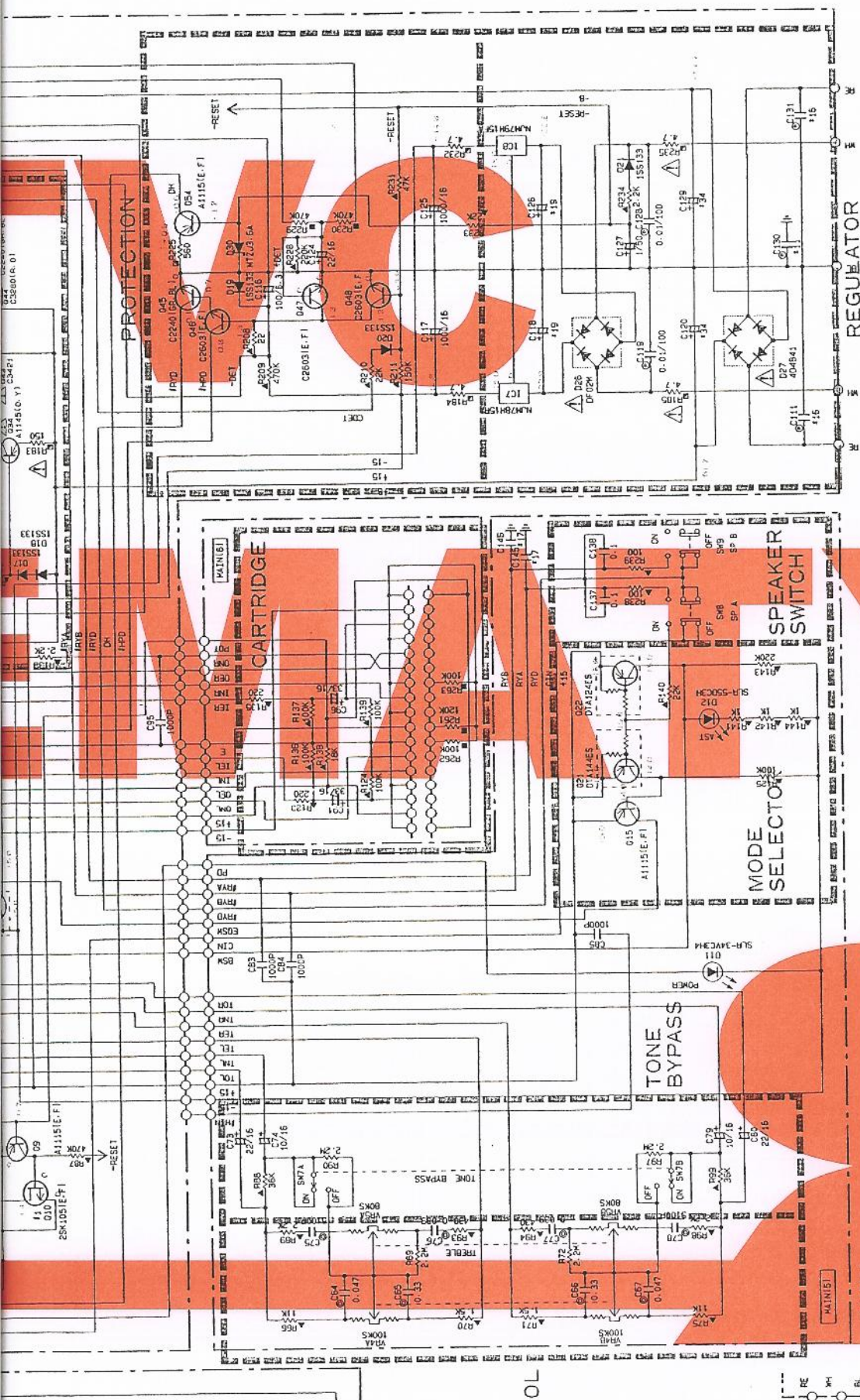

Interchangeable Parts at Manufacture-Stage

Mark	Reference Parts Number	Parts Name
41	G10	25K1051E.F1 25K1051F.H1

CAPACITOR

REMARKS	PARTS NAME	PARTS NAME
NO MARK	ELECTROLYTIC CAPACITOR	25K1051E.F1
NO MARK	TANTALUM CAPACITOR	25K1051F.H1
NO MARK	CERAMIC CAPACITOR	
	POLYESTER FILM CAPACITOR	
	POLYPROPYLENE FILM CAPACITOR	
	MICA CAPACITOR	
	POLYPROPYLENE FILM CAPACITOR	
	SEMICONDUCTIVE CERAMIC CAPACITOR	

RESISTOR

REMARKS	PARTS NAME	PARTS NAME
NO MARK	CARBON FILM RESISTOR	11ZEM1
	CARBON FILM RESISTOR	11Z4W1
	METAL OXIDE FILM RESISTOR	
	METAL FILM RESISTOR	
	METAL PLATE RESISTOR	
	FIBRE PROOF CARBON FILM RESISTOR	
	CEMENT MOLDED RESISTOR	
	SEMI VARIABLE RESISTOR	
	CHIP RESISTOR	

 NUM78M15FA NUM79M15FA	 4 PC4570G2-T1 BA4568F	 NUM5532SD NUM4568S-A
------------------------------	------------------------------	-----------------------------

* All voltages are measured with a 10MΩ/DC electric volt meter.
 * Components having special characteristics are marked Δ and must be replaced with parts having specifications equal to those originally installed.
 * Schematic diagram is subject to change without notice.

PHONO EQUALIZER AMP.

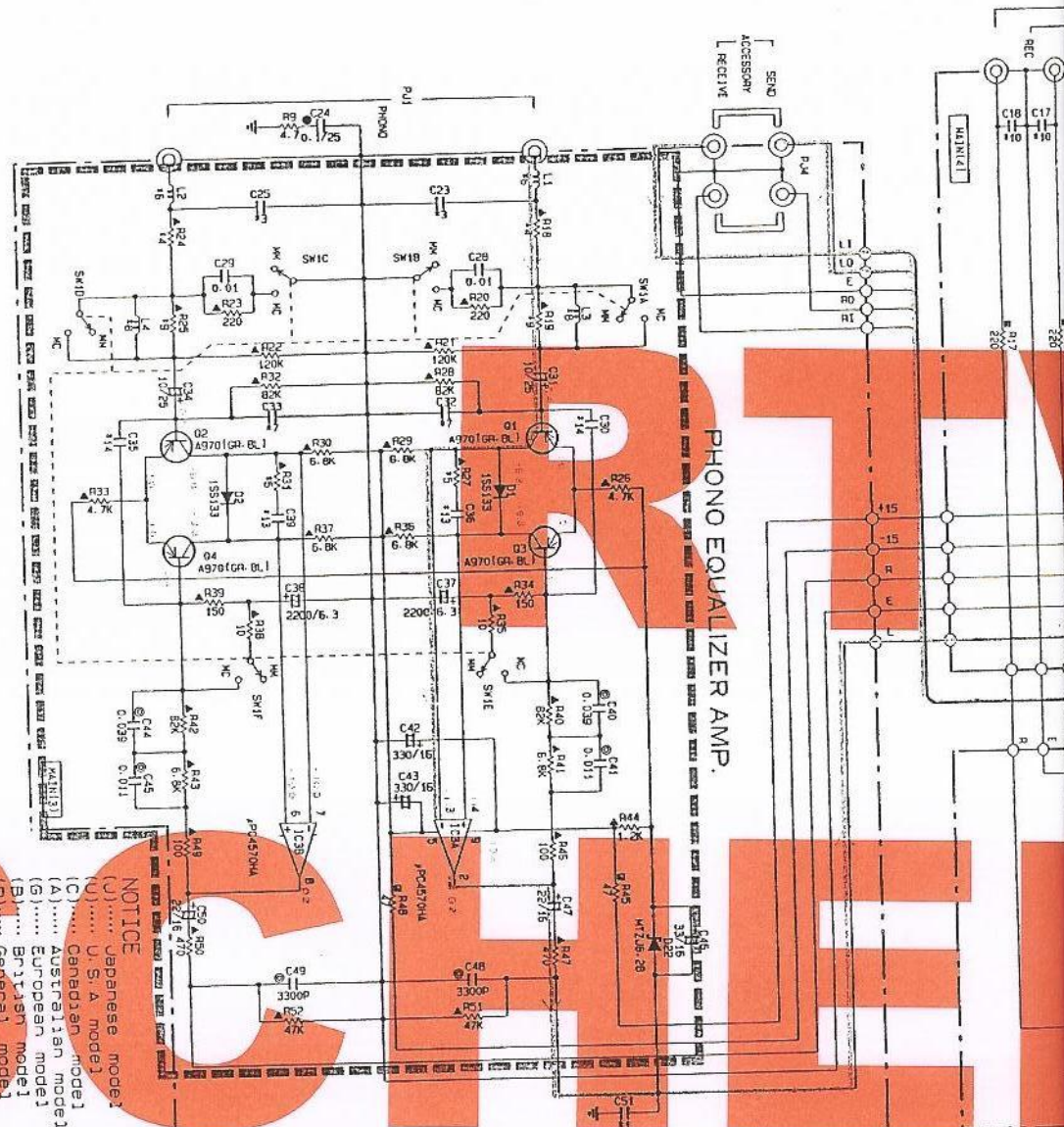

CONTROL

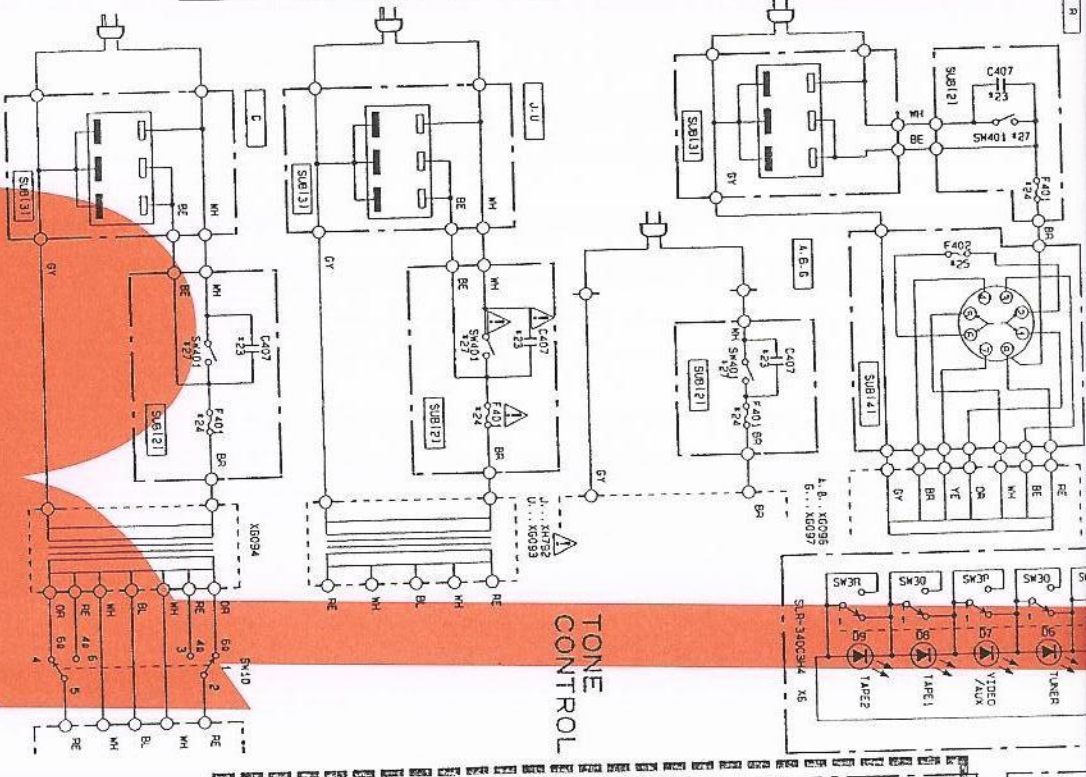

PIN CONNECTION DIAGRAM OF TRANSISTORS, DIODES AND ICs.

2SA970(G,R,B,L) 2SC2240(G,R,B,L) 2SC2878(A,B) 2SK105(F,H)	2SA1115 2SA2603 DTA144S DTA124ES	2SC2705(O,Y) 2SA1145	2SA1358 2SC3421	2SA1349	MTZJ6.2B 1SS133 MTZJ3.6A MTZJ5.6B	SLR-65URC3H SLR-34URC3H4 SLR-34YCSH4	4D4B41	μPC4570HA	NJM7 NJM7
--	---	-------------------------	--------------------	---------	--	--	--------	-----------	--------------

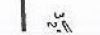
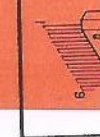
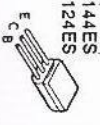

SCHEMATIC DIAGRAM

U	U/C	R	A	B	B	U	U/C	R	A	B	G
11	C51	OPEN			500P	114	C30, 35	OPEN			100P
12	C12	OPEN			0.01	115	C147-150	OPEN			47P
13	C23, 25	OPEN			20P	116	C111, 131	OPEN			0.047
14	R18, 24	10			33	117	C15, 146	OPEN			0.047
15	R27, 31	100			150	118	R255	OPEN			2.2
16	L1, 2	SHORT			154H	119	C118, 126	2200/35	1000/35		2.2
17	C22, 33	200P			200P	120	C19, 22	OPEN			1000/18
18	L3, 4	OPEN			250H	121	C22, 405	NUM352M	FC457082		0.022
19	R19, 25	33			2.2K	122	C401, 405	OPEN			0.01
110	C9-18	OPEN			470P	123	C402, 404	OPEN			0.01
111	C130	OPEN			0.1	124	F401	7.0A250V	7A125V	7.0A250V	7.0A250V
112	C151-153	OPEN			0.1	125	F402	7.0A250V	7A125V	7.0A250V	7.0A250V
113	C36, 39	1500P			2700P	126	F402	OPEN			2.2
126	F402	OPEN				127	SK401	VC40970	VC23490	VC40970	
128	R1-8	OPEN			100K	129	C1-4, 5, 8	OPEN			10/25
130	C19, 22	OPEN			22/16	130	C19, 22	OPEN			22/16
131	C26, 27	OPEN			1000/18	131	C26, 27	OPEN			1000/18
132	IC1, 2	OPEN			FC457082	132	IC1, 2	OPEN			FC457082
133	Q	SHORT			OPEN	133	Q	SHORT			OPEN
134	C120, 129	VC44280			VM4640	134	C120, 129	VC44280			VM4640
135	C28-32	DD18			0.047	135	C28-32	DD18			0.047

U	U/C	R	A	B	G
C	197				
R	406				
S	54				
D	30				
B	402				
	8				
	10				

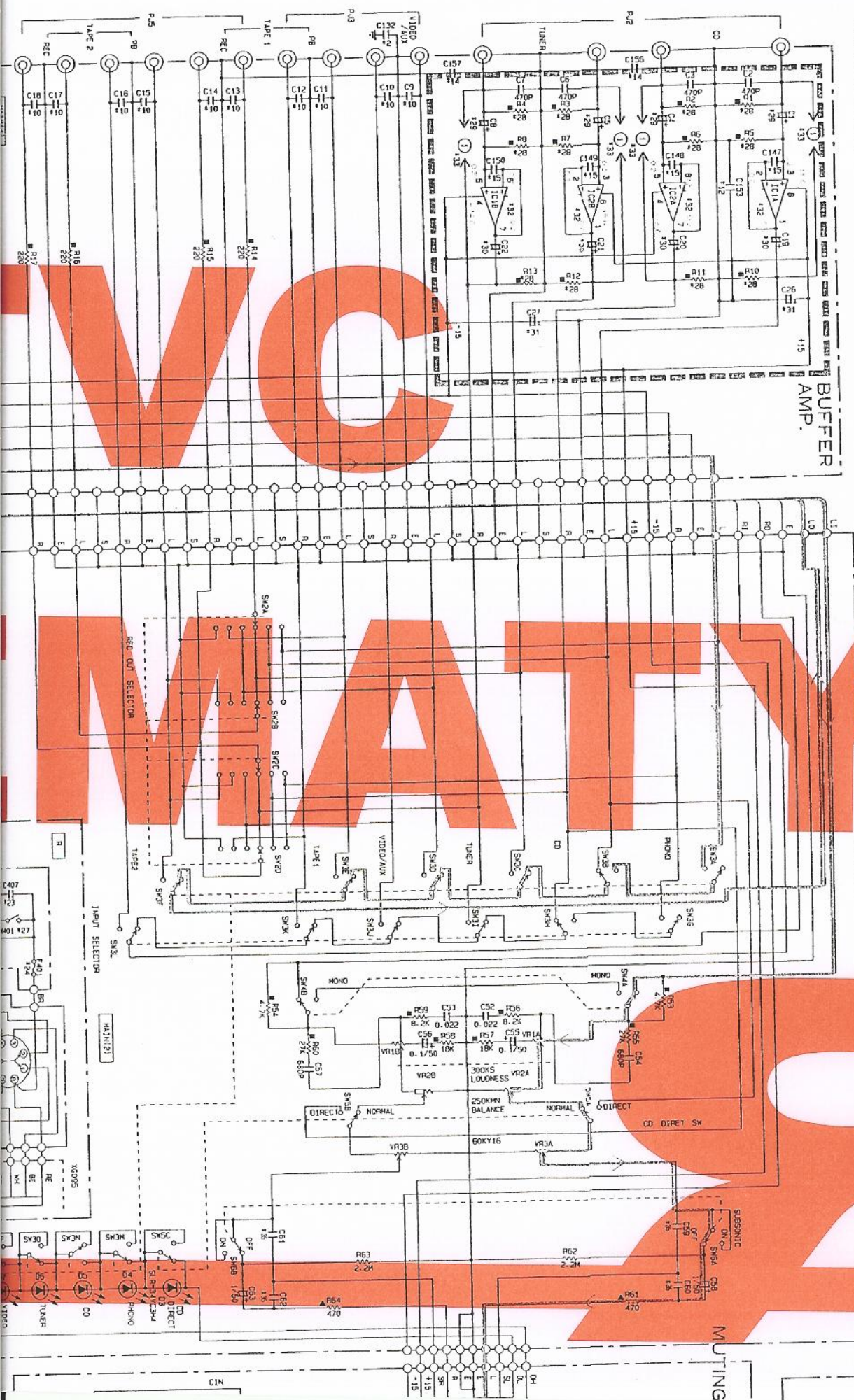

5

4

3

UNLISTED NO.

UNLISTED NO.