

AX-892 SCHEMATIC DIAGRAM (FUNCTION) / 総回路図 (ファンクション)

IC307, 308 : TA7291S Motor Drive

AX-892

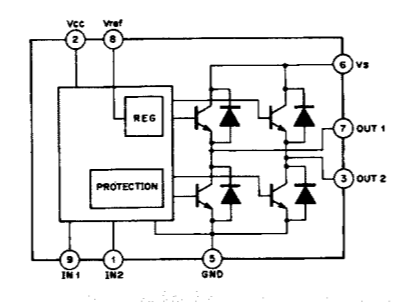
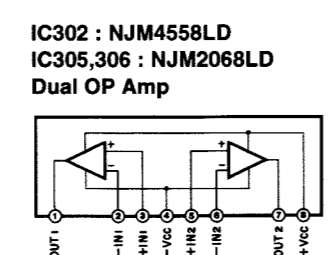
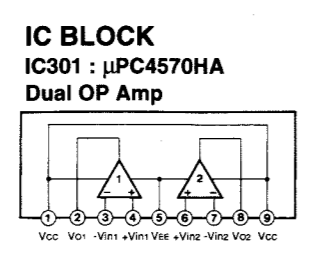

RESISTOR PARTS NAME table with various resistor types and values

CAPACITOR PARTS NAME table with various capacitor types and values

Interchangeable Parts at Manufacture-Stage table

TEST POINT WAVEFORMS / 波形ポイント

Point ① (Pin 22 of IC309) V: 2V/div H: 0.1μsec/div DC range 1:1 probe

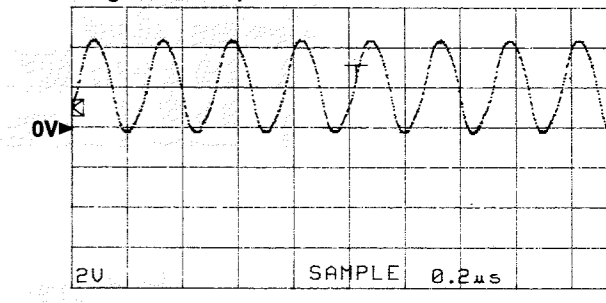

Point ② (CH1: Emitter of Q358 CH2: Pin 23 of IC309) V: 5V/div H: 0.5sec/div DC range 1:1 probe

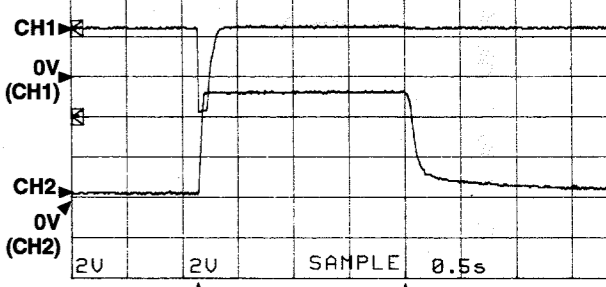

With the POWER switch turned ON, connect the power cord to the AC outlet. Disconnect the power cord from the AC outlet.

(This waveform is not available by pushing the power switch ON and OFF.)

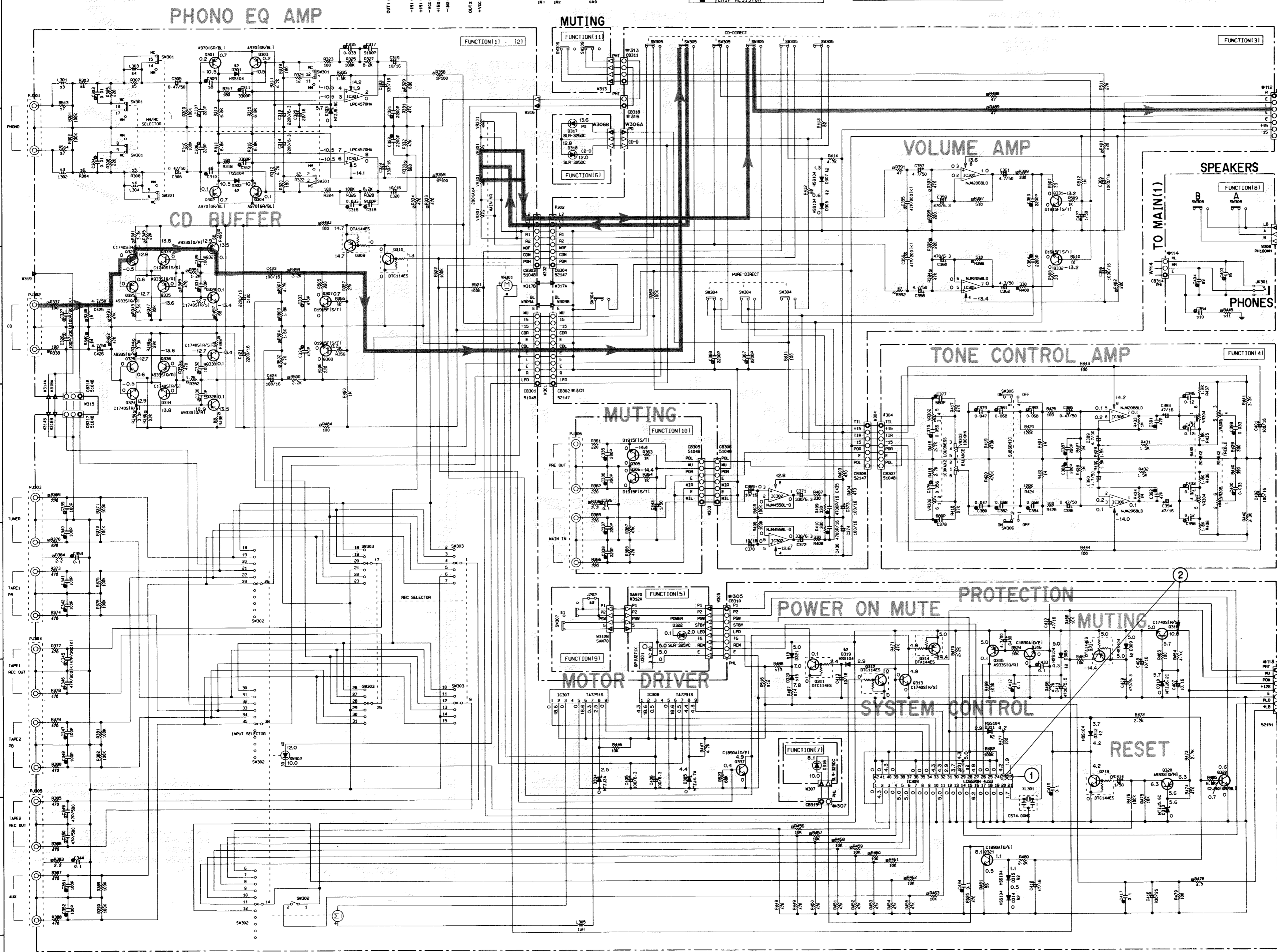

PIN CONNECTION DIAGRAM OF TRANSISTORS, DIODES AND ICs. Table with columns for part number, manufacturer, and pin connections.

PIN CONNECTION DIAGRAM OF TRANSISTORS, DIODES AND ICs.

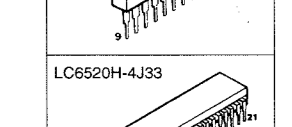
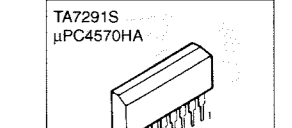
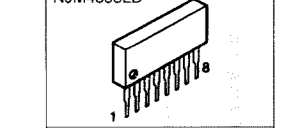
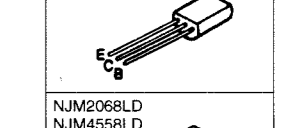
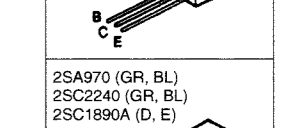
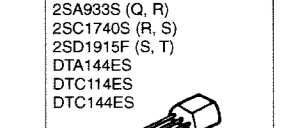
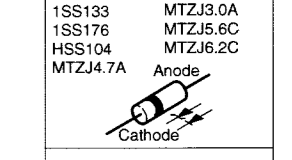

- Conditions / 設定条件: ● FUNCTION → CD, ● REC OUT → CD, ● SPEAKERS → A:ON, B:OFF, ● VOLUME → minimum (-∞)

All voltages are measured with a 10MΩ/2V DC electric volt meter. Components having special characteristics are marked Δ and must be replaced with parts having specifications equal to those originally installed. Schematic diagram is subject to change without notice.

電圧は、内部抵抗 10MΩ の電圧計で測定したものです。△印のある部品は、安全性確保部分を示しています。部品の交換が必要な場合、パーツリストに記載されている部品を使用してください。本回路図は、標準回路図です。改良のため予告なく変更することがあります。

AX-592 SCHEMATIC DIAGRAM (MAIN) / 総回路図 (メイン)

CAPACITOR

REMARKS	PARTS NAME	FIG.
NO MARK	ELECTROLYTIC CAPACITOR	83
◎	TANTALUM CAPACITOR	
NO MARK	CERAMIC CAPACITOR	11
◎	CERAMIC TUBULAR CAPACITOR	
◎	POLYESTER FILM CAPACITOR	
◎	POLYSTYRENE FILM CAPACITOR	
◎	MICA CAPACITOR	
◎	POLYPROPYLENE FILM CAPACITOR	
◎	SEMICONDUCTIVE CERAMIC CAPACITOR	

RESISTOR

REMARKS	PARTS NAME
NO MARK	CARBON FILM RESISTOR (P=5)
◎	CARBON FILM RESISTOR (P=10)
△	METAL OXIDE FILM RESISTOR
△	METAL FILM RESISTOR
△	METAL PLATE RESISTOR
△	FIRE PROOF CARBON FILM RESISTOR
△	CEMENT MOLDED RESISTOR
△	SEMI VARIABLE RESISTOR
■	CHIP RESISTOR

NOTICE (mode1)  
 (J)..... JAPANESE  
 (U)..... U. S. A  
 (C)..... CANADIAN  
 (R)..... GENERAL  
 (A)..... AUSTRALIAN  
 (B)..... BRITISH  
 (G)..... EUROPEAN  
 (T)..... CHINA  
 (L)..... SINGAPORE

Interchangeable Parts at Manufacture-Stage

Mark	Reference Parts Number	Part's Name
△1	D101-106-109-115-123	HSS104
		15S133
		15S176

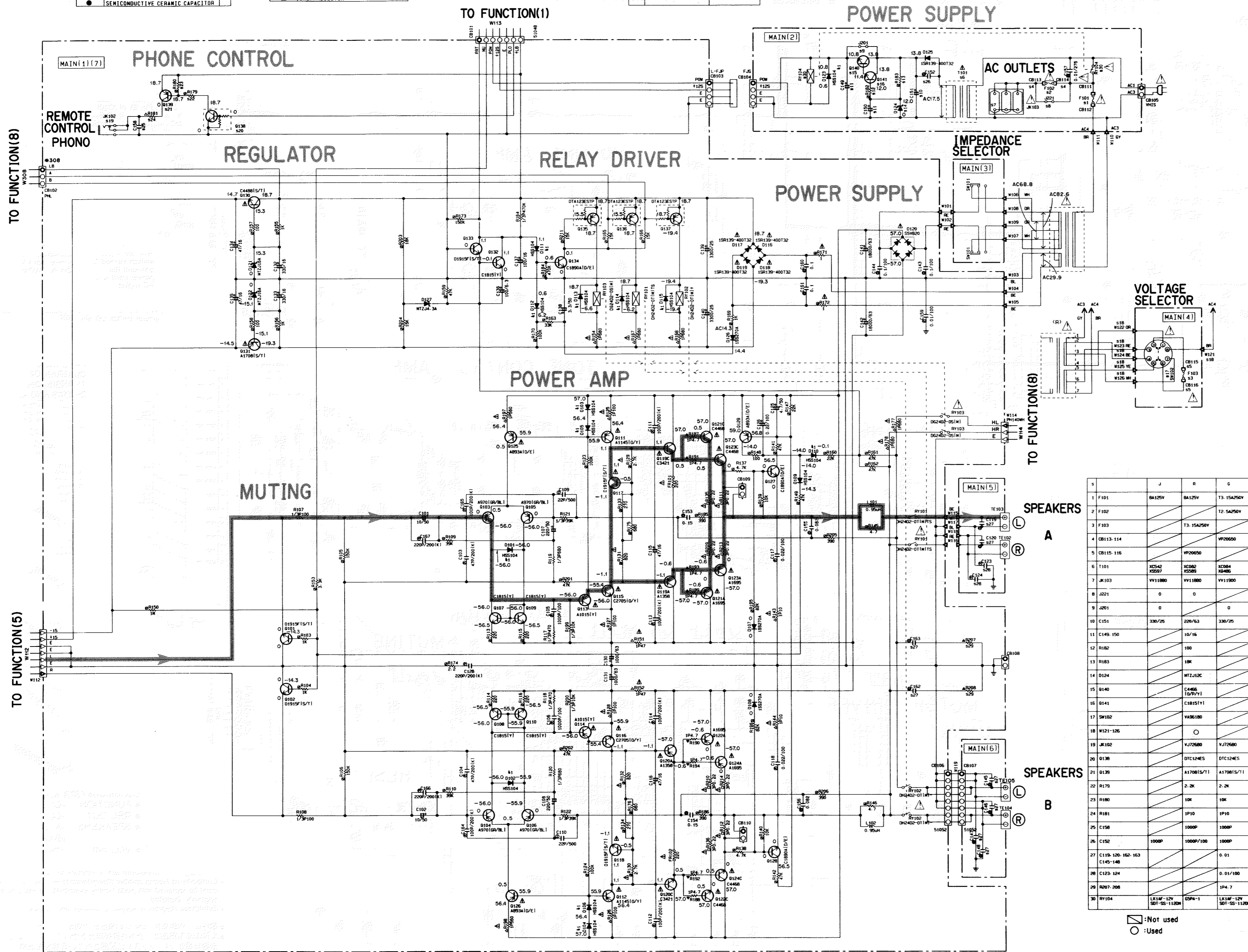

PIN CONNECTION DIAGRAM OF TRANSISTORS, DIODES AND ICs.

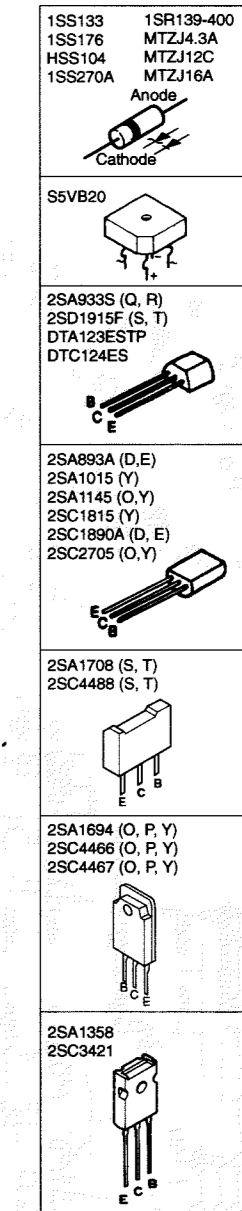

	J	R	G
1 F101	8A25V	8A125V	T3 15A250V
2 F102			T2 5A250V
3 F103			T3 15A250V
4 CB113-114			VP20650
5 CB115-116			VP20650
6 T101	K2542	K2582	K2084
	K2597	K2682	K2486
7 J103	VY11880	VY11880	VY11900
8 J201	0	0	0
9 J201	0	0	0
10 C151	330/25	200/63	330/25
11 C149-150		10/16	
12 R182		100	
13 R183		10K	
14 D124		MTZJ12C	
15 R140		C466	
16 D141		D19/Y1	
17 SW102		V436180	
18 W121-126		○	
19 J102		VJ72680	VJ72680
20 R138		DTC124ES	DTC124ES
21 R139		A170815/71	A170815/71
22 R179		2.2K	2.2K
23 R180		10K	10K
24 R181		1P10	1P10
25 C158		1000P	1000P
26 C152		1000P	1000P
27 C118-120-162-163			0.01
C145-146			0.01/100
28 C123-124			0.01/100
29 R207-208			1P4.7
30 RY104	LX14F-12V	CS94-1	LX14F-12V
	SD1-55-1120M		SD1-55-1120M

\* All voltages are measured with a 10MΩ/V DC electric volt meter.  
 \* Components having special characteristics are marked △ and must be replaced with parts having specifications equal to those originally installed.  
 \* Schematic diagram is subject to change without notice.

●電圧は、内部抵抗 10MΩの電圧計で測定したものです。  
 ●△印のある部品は、安全性確保部分を示しています。部品の交換が必要な場合、パーツリストに記載されている部品を使用してください。  
 ●本回路図は、標準回路図です。改良のため予告なく変更することがあります。

□: Not used  
 ○: Used