

STEREO CONTROL AMPLIFIER

C-50

SERVICE MANUAL

FRONT PANEL

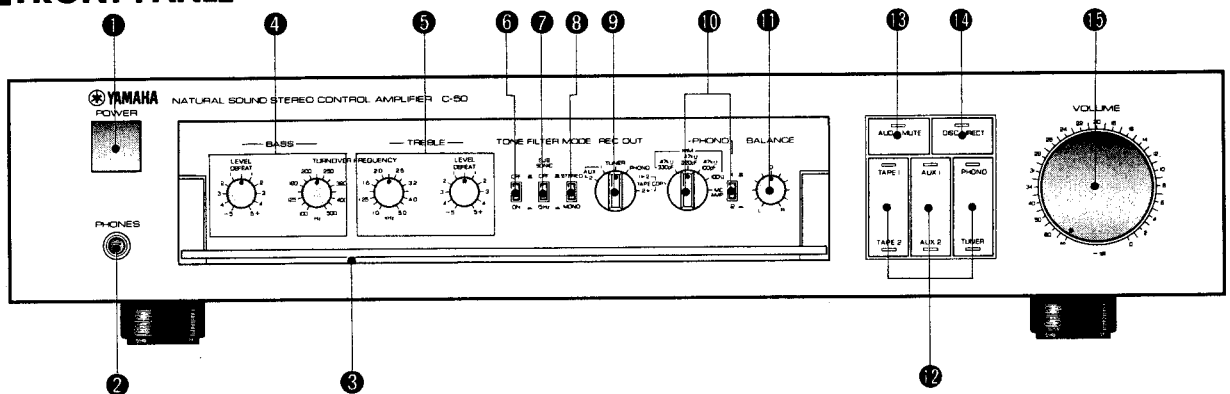

- | | |
|----------------------------|-----------------------|
| 1 POWER Switch | 9 REC OUT Switch |
| 2 Headphones Jack (PHONES) | 10 PHONO Switch |
| 3 Subcontrols panel cover | 11 BALANCE Control |
| 4 BASS Control | 12 Input Selector |
| 5 TREBLE Control | 13 AUDIO MUTE Switch |
| 6 TONE DEFEAT Switch | 14 DISC DIRECT Switch |
| 7 FILTER Switch | 15 VOLUME Control |
| 8 MODE Switch | |

CONTENTS

REAR PANEL	1
NAME OF THE PARTS	2
SPECIFICATIONS	2
DISASSEMBLY INSTRUCTIONS	3
BLOCK DIAGRAM	4
GENERAL ADJUSTMENT	5
Adjusting points	5
PRINTED CIRCUIT BOARD PATTERN-SIDE LAYOUT	6
PRINTED CIRCUIT BOARD PARTS-SIDE COMPONENTS LAYOUT/WIRING	7
COMPLETE CIRCUIT DIAGRAM	8

004460

SINCE 1887



YAMAHA

NIPPON GAKKI CO., LTD. HAMAMATSU, JAPAN

'82.4.2.65K Printed in Japan.

REAR PANEL

U.S.A. and Canadian Models

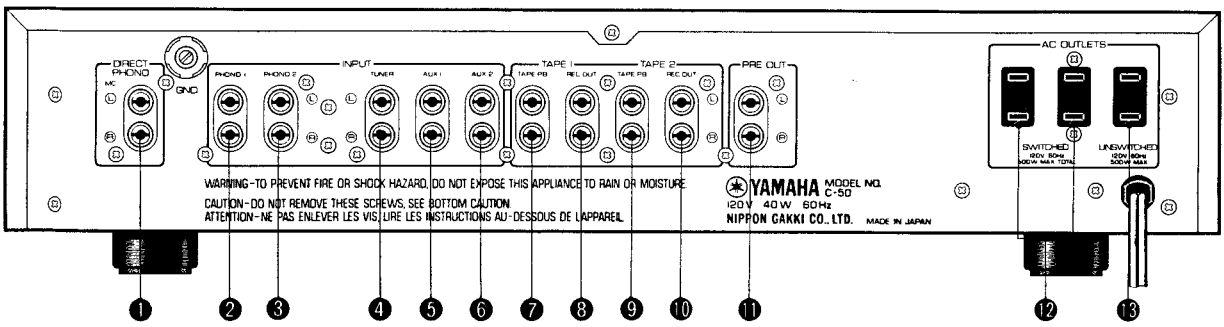

- 1 DIRECT PHONO MC input jacks
- 2 PHONO input jacks 1
- 3 PHONO input jacks 2
- 4 TUNER input jacks
- 5 AUX input jacks 1
- 6 AUX input jacks 2
- 7 TAPE 1/TAPE PB jacks
- 8 TAPE 1/REC OUT jacks
- 9 TAPE 2/TAPE PB jacks
- 10 TAPE 2/REC OUT jacks
- 11 PRE OUT jacks
- 12 AC OUTLETS (switched)
- 13 AC OUTLETS (unswitched)

Australian and British Models

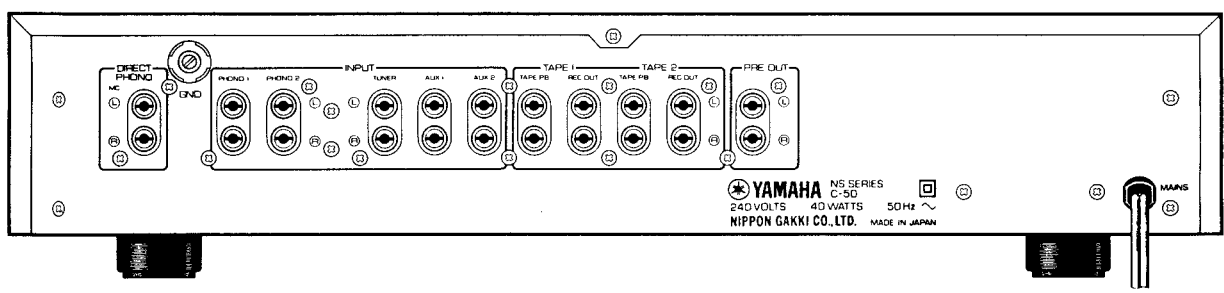

European Model

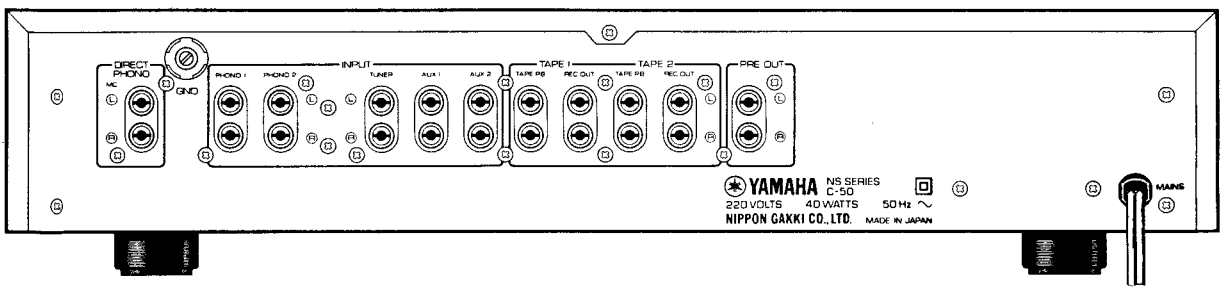

General Model

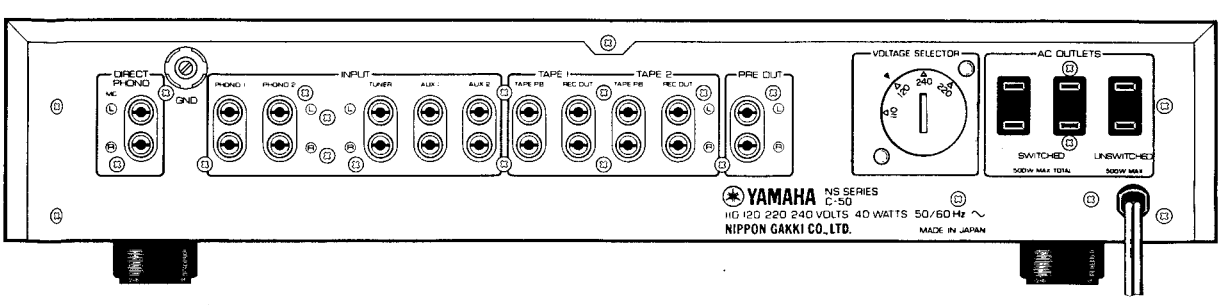

NAME OF THE PARTS

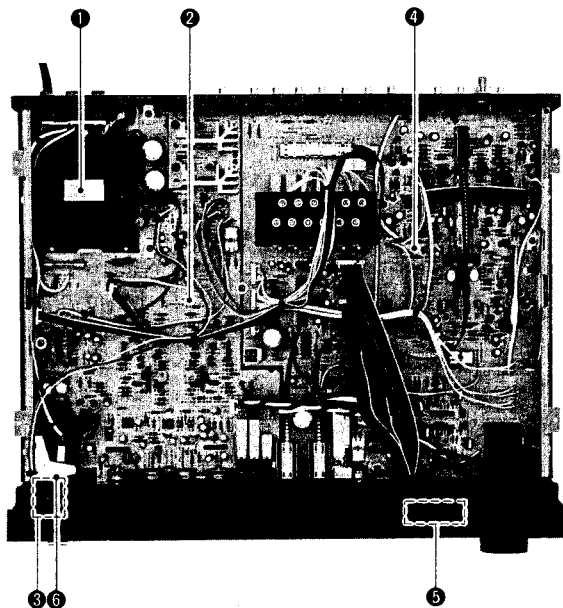

- ① Power transformer
- ② Tone control circuit board (1)
- ③ Tone control circuit board (2)
- ④ Equalizer circuit board (1)
- ⑤ Button unit
- ⑥ Power switch

SPECIFICATIONS

Input Sensitivity/Impedance

Phono MC	100 μ V/100 ohms
Phono MM	2.5 mV/100 ohms
100 pF	2.5 mV/47 kohms
220 pF	2.5 mV/47 kohms
330 pF	2.5 mV/47 kohms
Aux, Tape, Tuner	150 mV/47 kohms

Input Sensitivity (New IHF)

Phono MC	33 μ V
Phono MM	0.83 mV
Aux, Tape, Tuner	50 mV

Maximum Input Level (1 kHz, 0.01% THD/New IHF)

Phono MC	8.5 mV/8 mV
Phono MM	220 mV/220 mV

Output Level/Impedance

REC Out	150 mV/470 ohms
Pre Out	1.5 V/47 ohms

Maximum Output Level (20 Hz to 20 kHz, 0.1% THD)

Pre Out	10 V
---------	------

Headphone Maximum Output Level/Impedance

(1 kHz, 0.01% THD, Output impedance 68 ohms)	
	0.45 V/8 ohms
	4.0 V/100 ohms

Frequency Response

Aux, Tape, Tuner to Pre Out	+0, -0.5 dB (DC to 100 kHz)
-----------------------------	-----------------------------

RIAA Deviation

Phono MC, MM	\pm 0.2 dB (20 Hz to 20 kHz)
	\pm 0.5 dB (10 Hz to 100 kHz)

Total Harmonic Distortion (20 Hz to 20 kHz)

Phono MC to Rec Out	0.002% (3 V output)
Phono MM to Rec Out	0.001% (3 V output)
Aux, Tape, Tuner to Pre Out	0.001% (5 V output, tone switch OFF)

Intermodulation (Tone switch OFF)

Aux, Tape, Tuner	0.002% (5 V output)
------------------	---------------------

Signal to Noise Ratio (IHF-A-Network)

Phono MC	90 dB (500 μ V, Input shorted)
Phono MM	93 dB (5 mV, Input shorted)
Aux, Tape, Tuner	105 dB (Tone switch OFF)

Signal to Noise Ratio (New IHF)

Phono MC	80 dB
Phono MM	81 dB
Aux, Tape, Tuner	96 dB

Residual Noise

(IHF-A-Network)	2.5 μ V
-----------------	-------------

Channel Separatio

Phono MM 40 Hz	85 dB (Input shorted)
1 kHz	80 dB (Input shorted)
10 kHz	68 dB (Input shorted)
Aux, Tape 40 Hz	85 dB (5.1 kohms)
1 kHz	70 dB (5.1 kohms)
10 kHz	53 dB (5.1 kohms)

Tone Control Characteristics

Bass (boost/cut)	\pm 10 dB
Bass Turnover Frequency	100 to 500 Hz
Treble (boost/cut)	\pm 10 dB
Treble Turnover Frequency	1 to 5 kHz

Subsonic Filter

Characteristics	15 Hz, -12 dB/oct
-----------------	-------------------

Audio Muting

	-20 dB
--	--------

General

Power Supply	AC 120V, 60Hz (U, C)
	AC 220V, 50Hz (G)
	AC 240V, 50Hz (A, B)
	AC 110/120/220/240 V, 50/60 Hz (R)
	40 W

Power Consumption

AC Outlets	500W max total (Switched x2)
	500W max (Unswitched)

Dimensions (W x H x D)

	435 x 96.5 x 369 mm
	(17-1/8 x 3-3/4 x 14-1/2")

Weight

	6.8 kg (15.0 lbs)
--	-------------------

Specifications subject to change without notice.

- U: U.S.A Model
- C: Canadian Model
- R: General Model
- A: Australian Model
- B: British Model
- G: European Model

DISASSEMBLY INSTRUCTIONS

1. Removal of Top and Bottom Covers

- Remove screws ① ~ ⑤ shown in photo 1, and remove the top cover by pulling it in the direction indicated by the arrow.
- Remove screws ⑥ ~ ⑬ shown in photo 1 and remove the bottom cover. (Note that screw ⑪ is different from the other screws ⑥ ~ ⑬. When fastening the screws again, do not apply too much force, as this could deform the sub-chassis.)

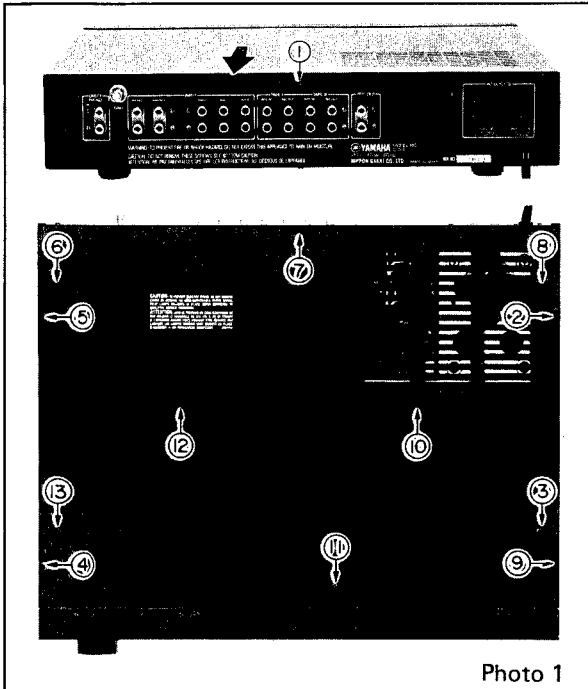

Photo 1

2. Removal of Front Panel

- Remove the top cover as described in step 1.
- Remove all knobs inside the subcontrol panel enclosure.
- Remove all wire connectors from the control button unit.
- When screws ① ~ ⑧ shown in photo 2 are re-

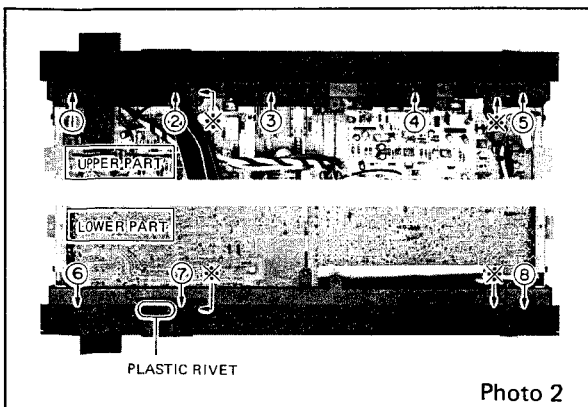

Photo 2

moved, the front panel can be removed with the subcontrol panel enclosure attached to it.

Note: The four screws marked with * in photo 2 are for the dismantling of the subcontrol panel enclosure. They should be removed only if the front panel or the subcontrol panel enclosure are to be replaced.

3. Removal of Control Button Unit

- Remove front panel as described in steps 1 and 2.
 - Pull out the two plastic rivets shown in photo 2 with a wire cutter or the like, as shown in fig. 1. The wire stay can now be removed.
 - When the front panel is lightly pushed from the outside, it comes off.
- * Be careful not to apply too much force, as this can damage the button unit.

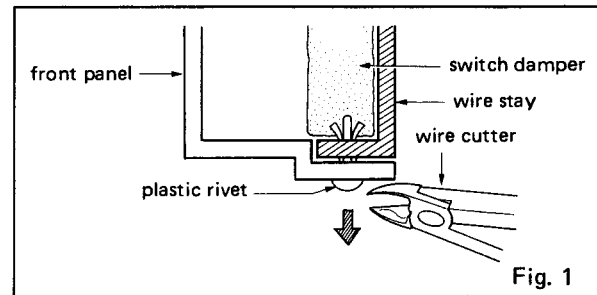
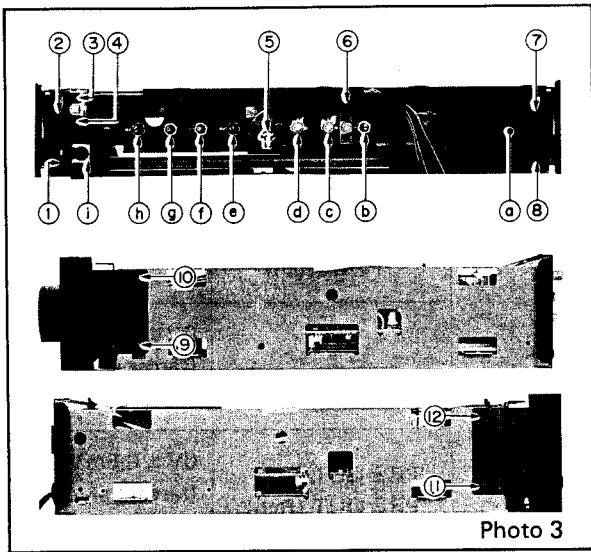

Fig. 1

4. Removal of Sub-chassis

- Perform steps 1. ~ 3.
- Loosen the volume control knob a shown in photo 3 with a hex wrench, remove it and the fastening nut from the shaft.
- Remove nuts ② ~ ④ shown in photo 3 and remove stopper ①.
- Remove screws ① ~ ⑫ shown in photo 3. The sub-chassis can now be removed.

*Adjustments or part replacements can now be performed.



■ BLOCK DIAGRAM

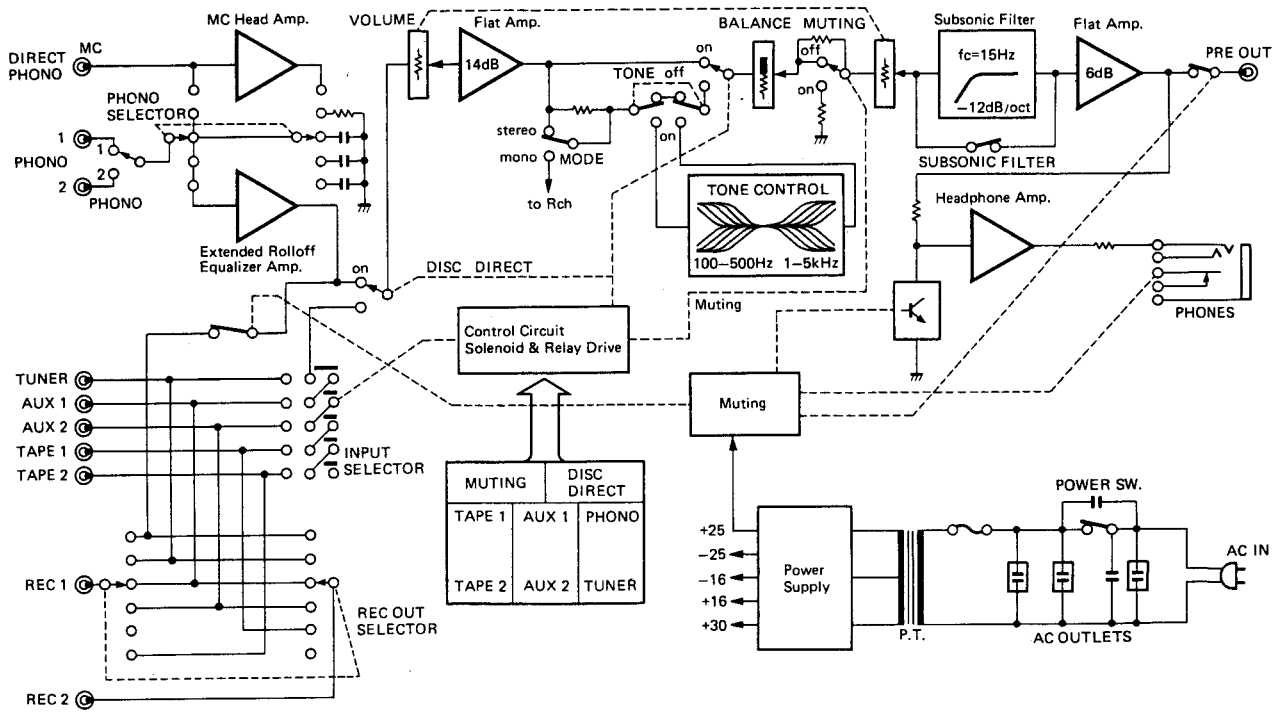

GENERAL ADJUSTMENTS

Before performing adjustments, turn on the power and wait 3 to 4 minutes, until amplifier operation has become stable.

Step	Adjustment Item	Adjustment Point	Instrument	Output Terminals Test Point	Rating
1	EQ AMP midpoint adjustment (equalizer circuit board (1))	VR101 (Lch) VR102 (Rch)	DC voltmeter	TP1-E (Lch) TP2-E (Rch)	$0 \pm 100\text{mV}$
2	FLAT AMP midpoint adjustment (equalizer circuit board (2))	VR103 (Lch) VR104 (Rch)		FL-E FR-E	$0\text{V} \pm 0.5\text{mV}$ (target value $0 \pm 0.2\text{mV}$)
3	FLAT AMP midpoint adjustment (tone control circuit board (1))	VR405 (Lch) VR406 (Rch)		PRE OUT (Lch) PRE OUT (Rch)	$0\text{V} \pm 0.5\text{mV}$ (target value $0 \pm 0.2\text{mV}$)

Adjusting points

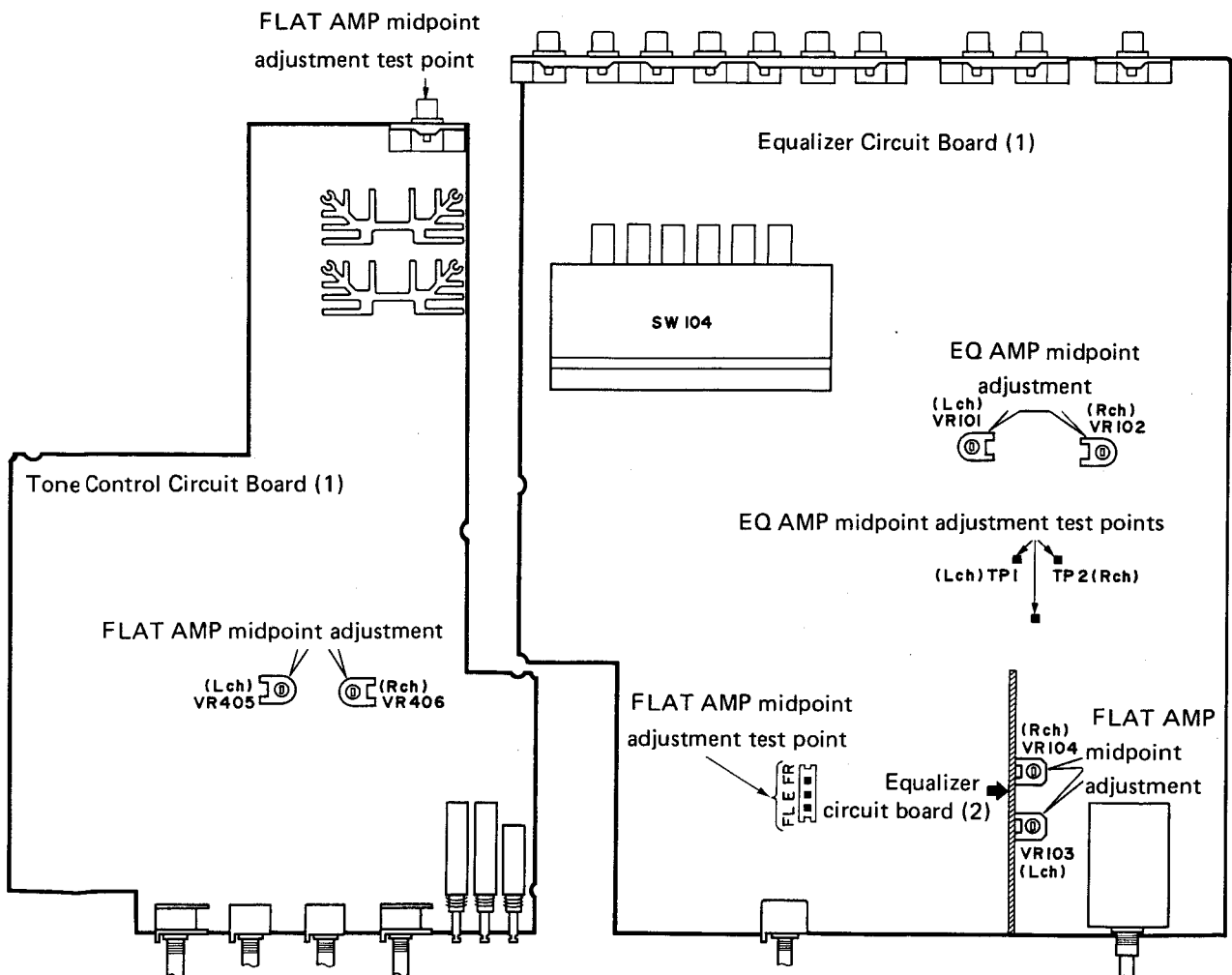

PRINTED CIRCUIT BOARD PATTERN-SIDE LAYOUT

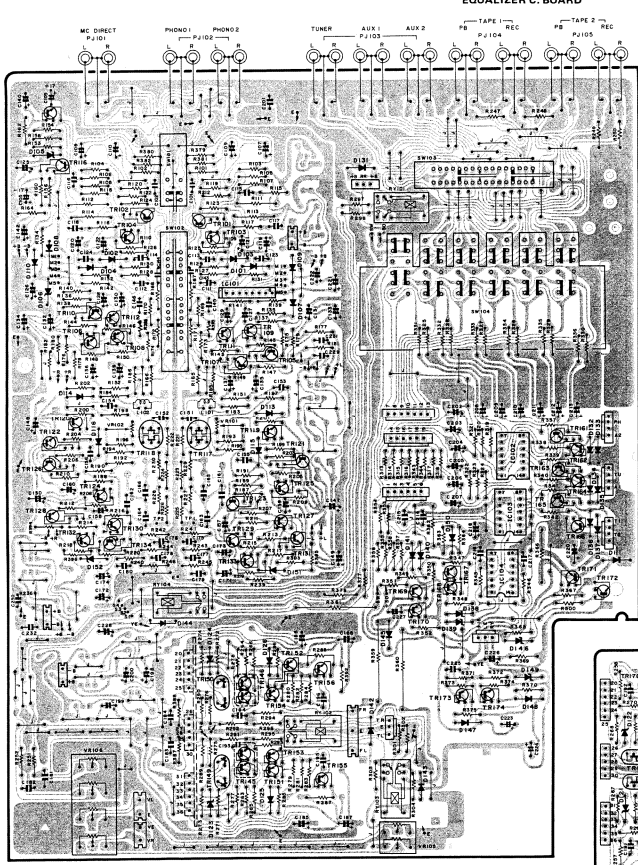

CONTROL C. BOARD

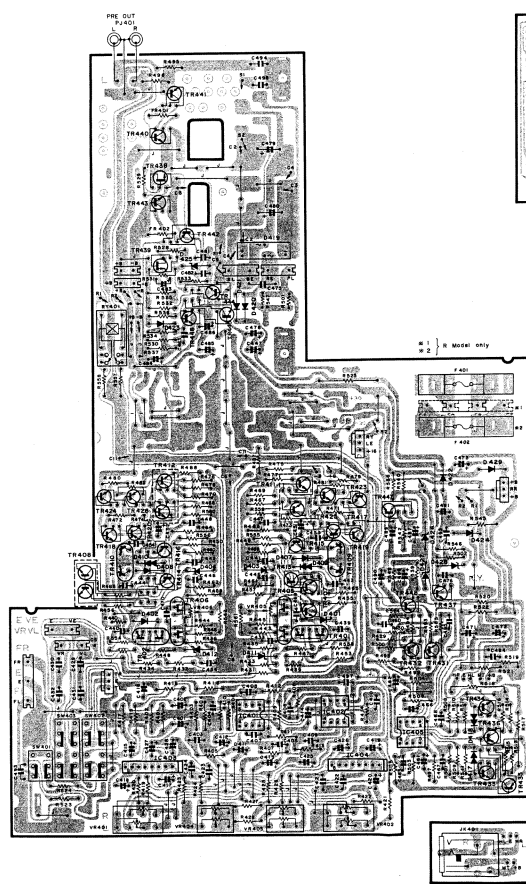

BUTTON UNIT C. BOARD

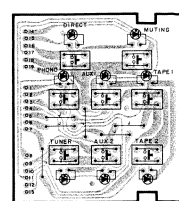

PRINTED CIRCUIT BOARD PARTS-SIDE COMPONENTS LAYOUT/WIRING

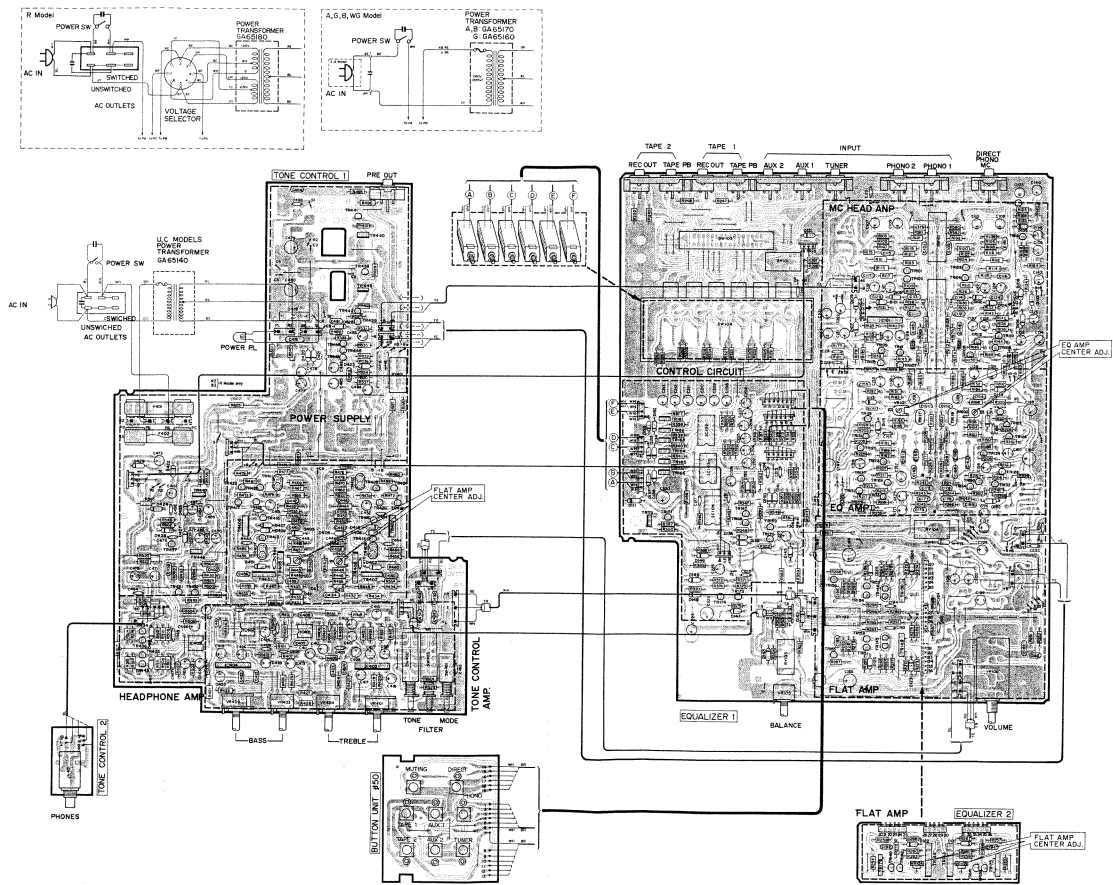

COMPLETE CIRCUIT DIAGRAM

1
2
3
4
5

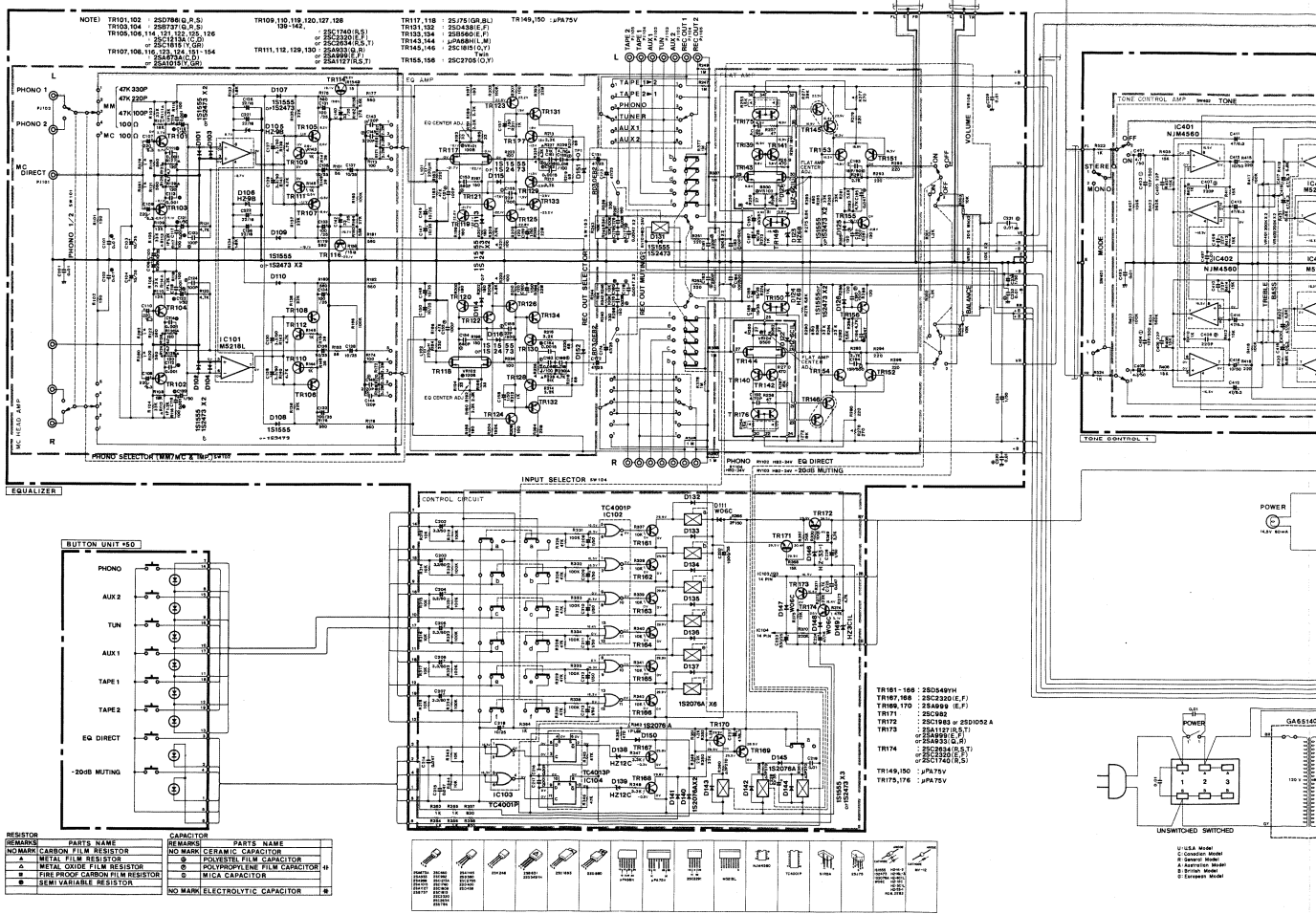

RESISTOR	PARTS NAME	CAPACITOR	PARTS NAME
NO MARK	CARBON FILM RESISTOR	NO MARK	CERAMIC CAPACITOR
A	METAL FILM RESISTOR	Ø	POLYESTER FILM CAPACITOR
Ø	METAL OXIDE FILM RESISTOR	⊙	POLYPROPYLENE FILM CAPACITOR
#	FINE PINK CARBON FILM RESISTOR	□	MICA CAPACITOR
■	SEMI VARIABLE RESISTOR	■	NO MARK ELECTROLYTIC CAPACITOR

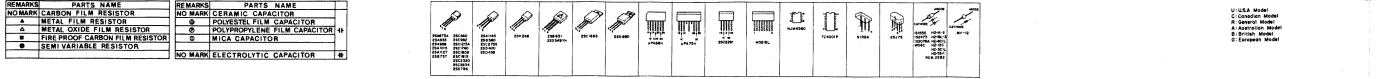
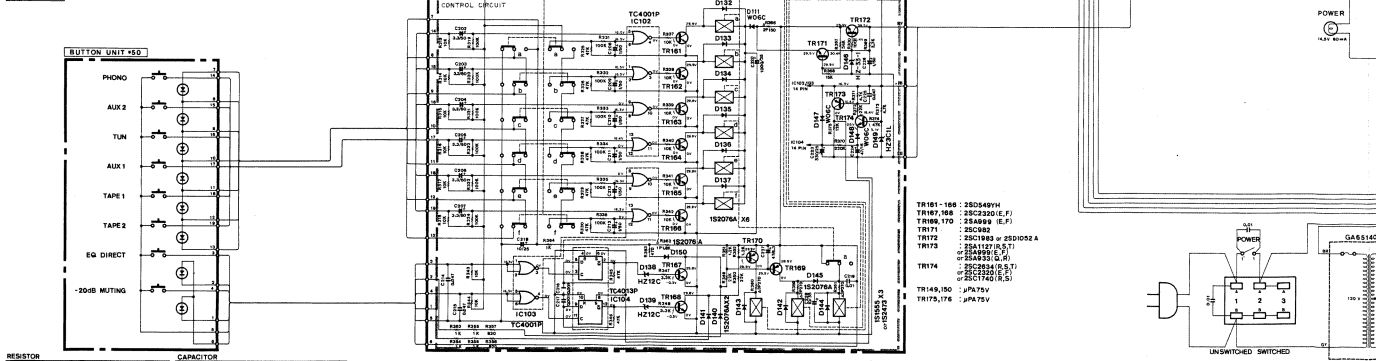
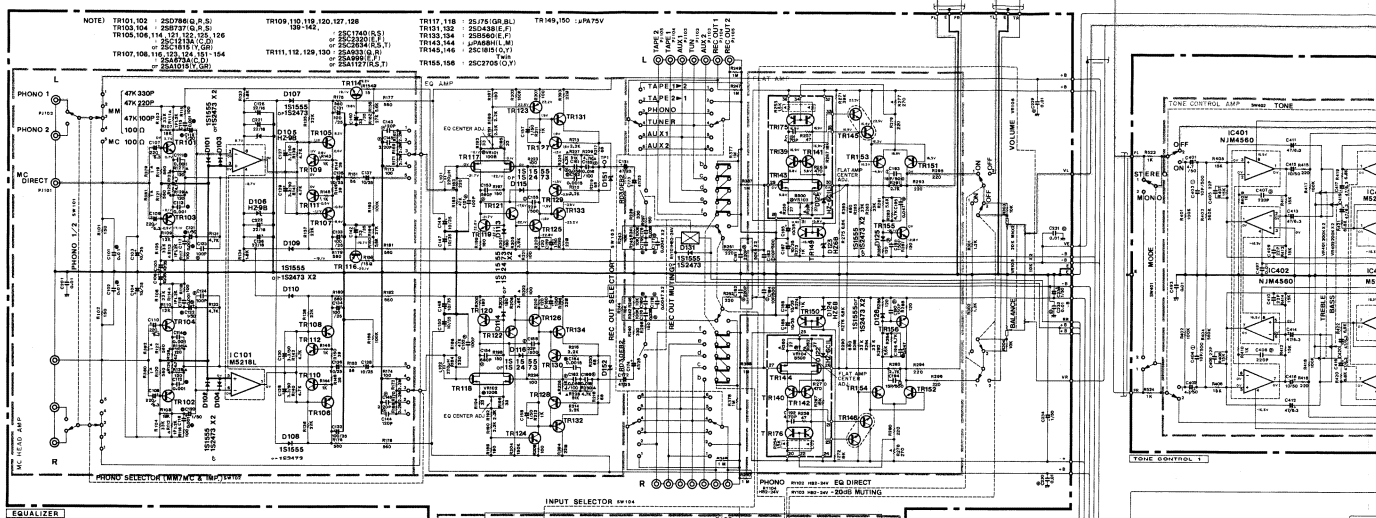
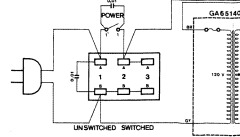
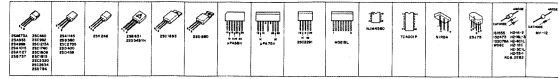

D E F G H I J K

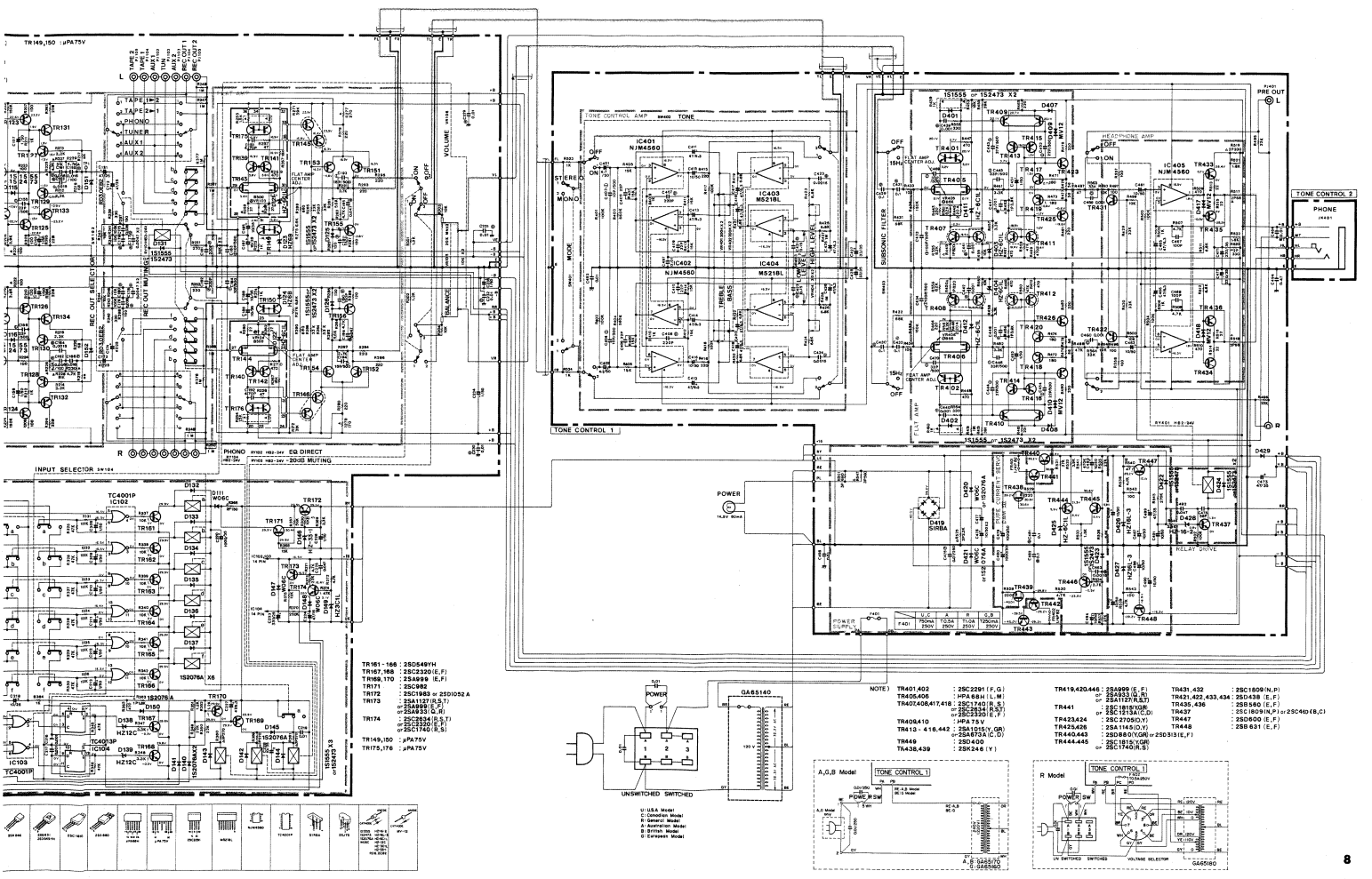

- TR101-106 : 2SC648YH
- TR107,108 : 2SC2330 (E,F)
- TR109,110 : 2SA999 (E,F)
- TR111 : 2SC982
- TR112 : 2SC1983 or 2SD1052A
- TR113 : 2SA1137 (A,B)
- TR114 : 2SA1143 (G,H)
- TR115 : 2SC2334 (G,H)
- TR116 : 2SC1720 (E,F)
- TR117 : 2SC1720 (E,F)
- TR118 : 2SC1720 (E,F)
- TR119 : 2SC1720 (E,F)
- TR120 : 2SC1720 (E,F)
- TR121 : 2SC1720 (E,F)
- TR122 : 2SC1720 (E,F)
- TR123 : 2SC1720 (E,F)
- TR124 : 2SC1720 (E,F)
- TR125 : 2SC1720 (E,F)
- TR126 : 2SC1720 (E,F)
- TR127 : 2SC1720 (E,F)
- TR128 : 2SC1720 (E,F)
- TR129 : 2SC1720 (E,F)
- TR130 : 2SC1720 (E,F)
- TR131 : 2SC1720 (E,F)
- TR132 : 2SC1720 (E,F)
- TR133 : 2SC1720 (E,F)
- TR134 : 2SC1720 (E,F)
- TR135 : 2SC1720 (E,F)
- TR136 : 2SC1720 (E,F)
- TR137 : 2SC1720 (E,F)
- TR138 : 2SC1720 (E,F)
- TR139 : 2SC1720 (E,F)
- TR140 : 2SC1720 (E,F)
- TR141 : 2SC1720 (E,F)
- TR142 : 2SC1720 (E,F)
- TR143 : 2SC1720 (E,F)
- TR144 : 2SC1720 (E,F)
- TR145 : 2SC1720 (E,F)
- TR146 : 2SC1720 (E,F)
- TR147 : 2SC1720 (E,F)
- TR148 : 2SC1720 (E,F)
- TR149 : 2SC1720 (E,F)
- TR150 : 2SC1720 (E,F)
- TR151 : 2SC1720 (E,F)
- TR152 : 2SC1720 (E,F)
- TR153 : 2SC1720 (E,F)
- TR154 : 2SC1720 (E,F)
- TR155 : 2SC1720 (E,F)
- TR156 : 2SC1720 (E,F)
- TR157 : 2SC1720 (E,F)
- TR158 : 2SC1720 (E,F)
- TR159 : 2SC1720 (E,F)
- TR160 : 2SC1720 (E,F)
- TR161 : 2SC1720 (E,F)
- TR162 : 2SC1720 (E,F)
- TR163 : 2SC1720 (E,F)
- TR164 : 2SC1720 (E,F)
- TR165 : 2SC1720 (E,F)
- TR166 : 2SC1720 (E,F)
- TR167 : 2SC1720 (E,F)
- TR168 : 2SC1720 (E,F)
- TR169 : 2SC1720 (E,F)
- TR170 : 2SC1720 (E,F)
- TR171 : 2SC1720 (E,F)
- TR172 : 2SC1720 (E,F)
- TR173 : 2SC1720 (E,F)
- TR174 : 2SC1720 (E,F)
- TR175 : 2SC1720 (E,F)
- TR176 : 2SC1720 (E,F)
- TR177 : 2SC1720 (E,F)
- TR178 : 2SC1720 (E,F)
- TR179 : 2SC1720 (E,F)
- TR180 : 2SC1720 (E,F)
- TR181 : 2SC1720 (E,F)
- TR182 : 2SC1720 (E,F)
- TR183 : 2SC1720 (E,F)
- TR184 : 2SC1720 (E,F)
- TR185 : 2SC1720 (E,F)
- TR186 : 2SC1720 (E,F)
- TR187 : 2SC1720 (E,F)
- TR188 : 2SC1720 (E,F)
- TR189 : 2SC1720 (E,F)
- TR190 : 2SC1720 (E,F)
- TR191 : 2SC1720 (E,F)
- TR192 : 2SC1720 (E,F)
- TR193 : 2SC1720 (E,F)
- TR194 : 2SC1720 (E,F)
- TR195 : 2SC1720 (E,F)
- TR196 : 2SC1720 (E,F)
- TR197 : 2SC1720 (E,F)
- TR198 : 2SC1720 (E,F)
- TR199 : 2SC1720 (E,F)
- TR200 : 2SC1720 (E,F)

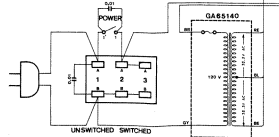

- NOTE: TR401,402 : 2SC2291 (F,G)
 TR403,404 : 2SC2291 (F,G)
 TR405,406 : 2SC2291 (F,G)
 TR407,408 : 2SC2291 (F,G)
 TR409,410 : 2SC2291 (F,G)
 TR411 : 2SC2291 (F,G)
 TR412 : 2SC2291 (F,G)
 TR413 : 2SC2291 (F,G)
 TR414 : 2SC2291 (F,G)
 TR415 : 2SC2291 (F,G)
 TR416 : 2SC2291 (F,G)
 TR417 : 2SC2291 (F,G)
 TR418 : 2SC2291 (F,G)
 TR419 : 2SC2291 (F,G)
 TR420 : 2SC2291 (F,G)
 TR421 : 2SC2291 (F,G)
 TR422 : 2SC2291 (F,G)
 TR423 : 2SC2291 (F,G)
 TR424 : 2SC2291 (F,G)
 TR425 : 2SC2291 (F,G)
 TR426 : 2SC2291 (F,G)
 TR427 : 2SC2291 (F,G)
 TR428 : 2SC2291 (F,G)
 TR429 : 2SC2291 (F,G)
 TR430 : 2SC2291 (F,G)
 TR431 : 2SC2291 (F,G)
 TR432 : 2SC2291 (F,G)
 TR433 : 2SC2291 (F,G)
 TR434 : 2SC2291 (F,G)
 TR435 : 2SC2291 (F,G)
 TR436 : 2SC2291 (F,G)
 TR437 : 2SC2291 (F,G)
 TR438 : 2SC2291 (F,G)
 TR439 : 2SC2291 (F,G)
 TR440 : 2SC2291 (F,G)
 TR441 : 2SC2291 (F,G)
 TR442 : 2SC2291 (F,G)
 TR443 : 2SC2291 (F,G)
 TR444 : 2SC2291 (F,G)
 TR445 : 2SC2291 (F,G)

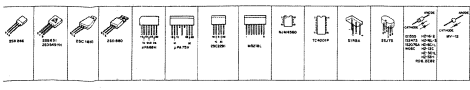
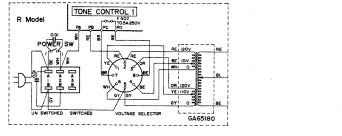
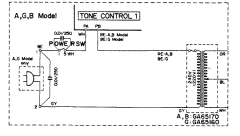

PARTS LIST

C-50

STEREO CONTROL AMPLIFIER

■CONTENTS	Page
■EXPLODED VIEW (Allover).....	1
■PARTS LIST (Allover).....	2
■PARTS LIST (Circuit Board)	
Equalizer Circuit Board.....	4
Tone Control Circuit Board.....	11

Notes

DESTINATION ABBREVIATIONS

U	U.S.A
C	CANADIAN
G	EUROPEAN
B	BRITISH
R	GENERAL
A	AUSTRALIAN
J	JAPAN

004460

EXPLODED VIEW(Allover)

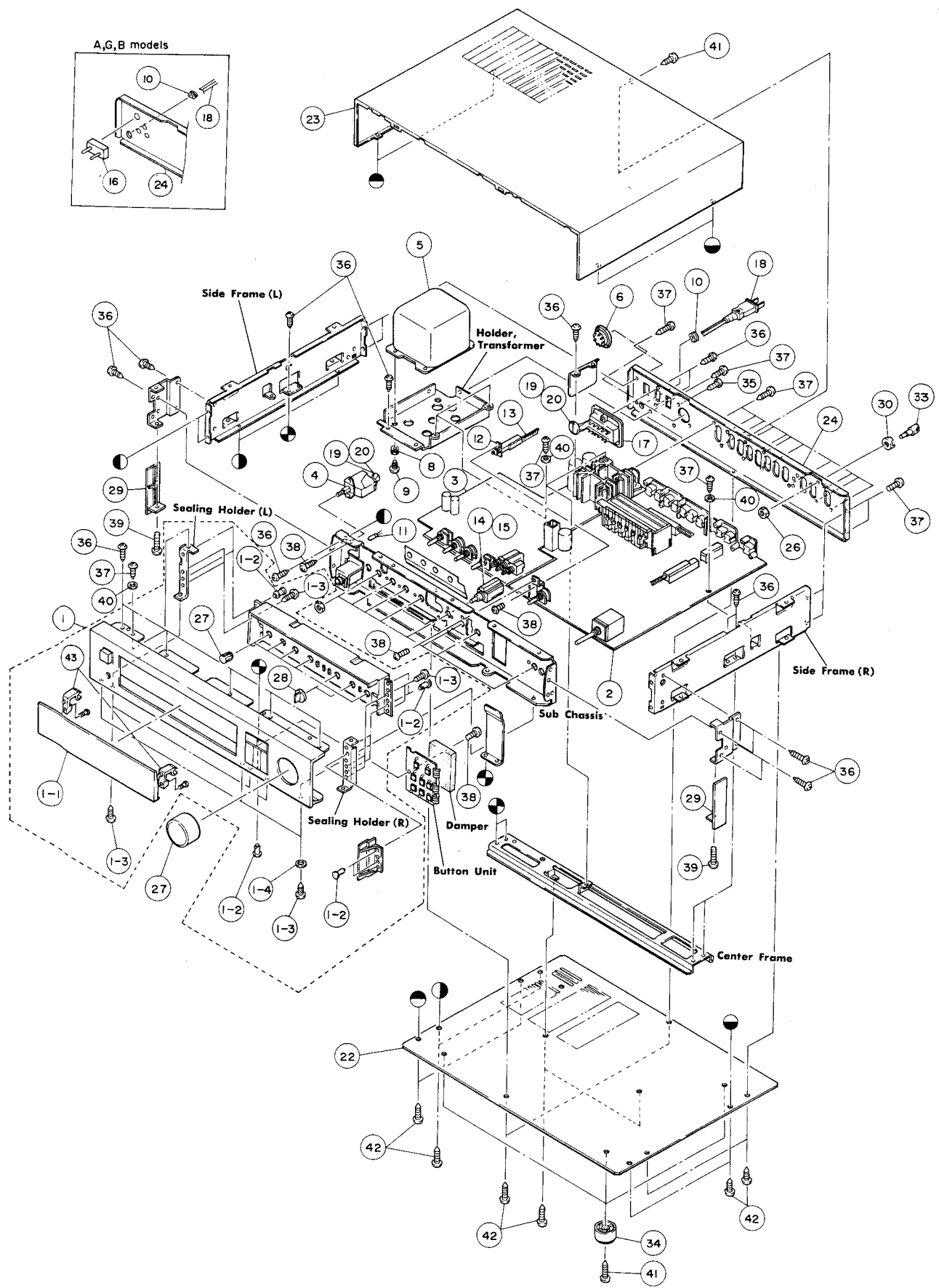

■PARTS LIST(Allover)

C-50 C-50

Ref. No.	Part No.	Description	(部 品 名)	Remarks	Common model	Markets
1	NB:60:43:40	Panel Unit	パネルユニット			
1.1	BA:08:23:40	Sealing Panel	シーリングパネル			
1.2	CB:06:88:80	Plastic Rivet	プラスチックリベット			
1.3	ED:33:00:60	Bind Head Screw	M3×6(ZMC2-Bf) 鉄バンド小ネジ			
1.4	EV:20:30:30	Plain Washer	M3(FCM3-Bf) 平座金			
2	NA:07:84:30	Equalizer C.Board	イコライザーシート		J	
*	NA:07:84:40	*	*		R, U, A, G, C, B	
3	NA:07:84:50	Tone Control C.Board	トーンコントロールシート		J	
*	NA:07:84:60	*	*		R	
*	NA:07:84:70	*	*		U, C	
*	NA:07:84:80	*	*		A	
*	NA:07:84:90	*	*		G, B	
4	KA:80:24:70	Push Switch	SS-13S5A/40A ブッシュスイッチ		C-70	A, G, B
*	KA:80:25:50	*	SDZIP-A TV-8		*	R, U, C
*	KA:80:26:20	*	SDZIP125V15A		*	J
5	GA:65:13:00	Power Transformer	電源トランス		J	
*	GA:65:14:00	*	*			U, C
*	GA:65:16:00	*	*			G
*	GA:65:17:00	*	*			A, B
*	GA:65:18:00	*	*			R
8	LB:20:14:80	Voltage Selector	O211 電圧切換器			R
8	CB:60:93:60	Anti Vibration Tape	防振ゴム		C-70	
9	AA:60:38:50	Step Screw	段付ネジ		A760	
10	CB:07:27:50	Cord Stopper	SR-4N-4 コードストッパー			
11	JB:00:06:10	Pilot Lamp Lead type	14.5V 80mAパイロットランプリード式			
12	KA:90:13:00	Remote Push Switch	(Operate Section) リモートブッシュSW			
*	KA:90:28:30	*	*			
14	KA:90:28:50	Remote Rotary Switch	(Operate+ Wire section) リモートロータリーSW	REC OUT		
15	KA:90:28:80	*	(*)	PHONO		
16	LA:00:29:50	Relay Terminal 2P	MA0092A 2P中継端子台			A, G, B
17	LB:60:39:20	AC Outlet triplet	MD-86-4 ACアウトレット3連			R, U
*	LB:60:43:20	*	PMD-86-3			C
18	MG:00:12:10	AC Cord	Black 2m 15A 250V 電源コード			J
*	MG:00:07:80	*	6A 250V			R
*	MG:00:13:60	* Flat type	13A 125V			U, C
*	MG:00:09:10	*	6A 250V			G
*	MG:00:09:20	*	Gray 2.5m 7.5A 250V			A
*	MG:00:10:00	*	Black 2m 6A 300V 500V			B
19	Fi:32:41:00	Ceramic Capacitor	0.01μF AC 250V(IDE) セラコン		C-70	J
*	Fi:34:41:00	*	0.01μF MY(IDE)		*	R, U, C
*	FR:16:41:00	*	0.01μF AC250V MPコン		*	A, G, B
20	CB:07:21:90	Cover for Capacitor	SB-0832-B コンデンサーカバー角型		*	A, G, B
*	CB:09:52:60	*	SB-0833 * 丸型		*	R, U, C
*	CB:60:19:00	*	HY-0103 * 半丸型		*	J
21	CB:09:95:80	Cover for Fuse Holder	SB-0864U ヒューズホルダーカバー			U
22	AA:61:01:00	Bottom Cover	ボトムカバー		C-70	
23	AA:61:00:80	Top Cover	トップカバー		*	
24	AA:61:02:40	Rear Panel (J)	リヤパネル		J	
*	AA:61:02:50	* (R)	*			R
*	AA:61:02:60	* (U)	*			U
*	AA:61:02:70	* (G)	*			G
*	AA:61:02:80	* (B)	*			B

* : New Parts (新部品)

Ref. No.	Part No.	Description	(部 品 名)	Remarks	Common model	Markets
25	BA:08:23:60	Knob	ツマミ		C-70	
26	AA:09:57:20	Bonding Nut	ボンディングナット		CA810	
27	CB:60:76:70	Knob	ツマミ		C-70	
28	CB:60:76:80	Knob, Switch	SWツマミ		*	
29	CB:60:76:90	Slide Plate	サイドプレート		*	
30	CB:60:93:40	Shield Plate	シールドプレート		*	
32	CB:09:93:40	Saucer	皿皿			
33	NB:08:14:80	Terminal Unit	ターミナルユニット		CA-1010	
34	CB:07:59:00	Leg	脚			
35	CB:06:88:80	Plastic Rivet	プラスチックリベット			R
36	EN:33:00:10	Bind Head Tapping Screw	3×8(FCM3-Bf) 鉄バンドタッピングネジ	Type-II		
37	EN:03:00:20	*	3×8(ZMC2-Y)			
38	ED:33:00:60	Bind Head Screw	M3×6(ZMC2-Bf) 鉄バンド小ネジ			
39	ED:33:01:40	*	M3×14(*)			
40	EV:20:30:00	Plain Washer	M3(ZMC2-Y) 平座金			
41	Ei:33:01:40	Bind Head Tapping Screw	3×14(ZMC2-Bf) 鉄バンドタッピングネジ			
42	Ei:33:00:80	*	3×8(FCM3-Bf)			
43	CB:60:76:30	Hinge	ヒンジ			
		Accessories Assembly	付属品Ass'y		M-50	
	Mi:06:99:20	Pin Cord	ピンコード			

* : New Parts (新部品)

■PARTS LIST(Circuit Board)

C-50 C-50

Ref No.	Part No.	Description	(部 品 名)	Remarks	Common model	Markets
	NA 07 84 40	Equalizer Circuit Board	イコライザシート			R,U,A,G,C,B
* C101	UA 25 41 00	Mylar Capacitor	マイラーコン			
C102	UA 25 41 00	Mylar Capacitor	マイラーコン			
* C103	UW 95 71 00	Electrolytic Capacitor	ケミコン			
C107	UW 91 82 20	Electrolytic Capacitor	ケミコン			
C110	UA 25 31 00	Mylar Capacitor	マイラーコン			
* C119	UW 96 61 00	Electrolytic Capacitor	ケミコン			
C123	FT 51 21 00	Polypropylene Capacitor NP	ポリプロコン			
C124	UW 83 72 20	Electrolytic Capacitor	ケミコン			
* C125	UW 83 72 20	Electrolytic Capacitor	ケミコン			
C126	UW 96 63 30	"	"			
C127	UW 96 63 30	"	"			
C130	UW 96 63 30	"	"			
C131	UW 94 81 00	Electrolytic Capacitor	ケミコン			
C134	UW 94 81 00	Electrolytic Capacitor	ケミコン			
* C136	UW 94 71 00	Electrolytic Capacitor	ケミコン			
C138	UW 94 71 00	Electrolytic Capacitor	ケミコン			
C140	UW 95 73 30	"	"			
C142	UW 95 73 30	"	"			
* C143	FT 51 21 20	Polypropylene Capacitor NP	ポリプロコン			
C144	FT 51 21 20	Polypropylene Capacitor NP	ポリプロコン			
* C148	FT 51 22 20	"	"			
C149	FT 51 22 20	"	"			
* C147	UW 95 71 00	Electrolytic Capacitor	ケミコン			
C150	UW 95 71 00	Electrolytic Capacitor	ケミコン			
* C151	FT 51 21 00	Polypropylene Capacitor NP	ポリプロコン			
C152	FT 51 21 00	Polypropylene Capacitor NP	ポリプロコン			
* C153	FT 51 25 60	" NP	"	Interchangeable (互換品)		
C154	FT 51 25 60	" NP	"	Interchangeable (互換品)		
* C155	FT 51 25 60	" APS	"			
C156	FT 51 25 60	" APS	"			
* C159	FU 35 12 20	Mica Capacitor FE	マイカコン			
C160	FU 35 12 20	Mica Capacitor FE	マイカコン			
* C162	UW 86 61 00	Electrolytic Capacitor	ケミコン			
C163	UW 86 61 00	Electrolytic Capacitor	ケミコン			
* C181	FT 86 45 60	Polypropylene Capacitor APS	ポリプロコン			
C182	FT 86 45 60	Polypropylene Capacitor APS	ポリプロコン			
* C183	UA 25 31 50	Mylar Capacitor	マイラーコン			
C184	UA 25 31 50	Mylar Capacitor	マイラーコン			
* C185	FT 66 41 60	Polypropylene Capacitor APS	ポリプロコン			
C186	FT 66 41 60	Polypropylene Capacitor APS	ポリプロコン			
C171	UW 94 74 70	Electrolytic Capacitor	ケミコン			
C174	UW 94 74 70	Electrolytic Capacitor	ケミコン			
* C175	UA 25 43 60	Mylar Capacitor	マイラーコン			
C176	UA 25 43 60	Mylar Capacitor	マイラーコン			
* C177	UA 25 34 70	"	"			
C178	UA 25 34 70	"	"			
* C181	FT 51 22 20	Polypropylene Capacitor NP	ポリプロコン			
C182	FT 51 22 20	Polypropylene Capacitor NP	ポリプロコン			
* C183	FU 35 11 00	Mica Capacitor FE	マイカコン			
C184	FU 35 11 00	Mica Capacitor FE	マイカコン			
* C186	UW 95 71 00	Electrolytic Capacitor	ケミコン			
C188	UW 95 71 00	Electrolytic Capacitor	ケミコン			
* C189	FT 51 21 50	Polypropylene Capacitor NP	ポリプロコン			
C190	FT 51 21 50	Polypropylene Capacitor NP	ポリプロコン			
* C191	FT 51 24 70	"	"	Interchangeable (互換品)		
C192	FT 51 24 70	"	"	Interchangeable (互換品)		
* C193	FU 35 11 50	Mica Capacitor FE	マイカコン			
C194	FU 35 11 50	Mica Capacitor FE	マイカコン			
* C195	UA 25 44 70	Mylar Capacitor	マイラーコン			
C196	UA 25 44 70	Mylar Capacitor	マイラーコン			
C201	FG 44 41 00	Ceramic Capacitor	セラコン			
C202	UW 96 63 30	Electrolytic Capacitor	ケミコン			
C207	UW 86 61 00	"	"			
C208	UW 86 61 00	"	"			
C213	FG 44 44 70	Ceramic Capacitor	セラコン			
C214	FG 44 44 70	Ceramic Capacitor	セラコン			
C216	FG 41 31 00	"	"			
C217	FG 41 31 00	"	"			
* C218	UW 84 71 00	Electrolytic Capacitor	ケミコン			
C219	FG 44 41 00	Ceramic Capacitor	セラコン			

* : New Parts (新部品)

Ref No.	Part No.	Description	(部 品 名)	Remarks	Common model	Markets
* C220	UW 95 91 00	Electrolytic Capacitor	1000µF 35V	ケミコン		
C221	UW 83 72 20	"	22µF 16V	"		
C223	UW 94 83 30	"	330µF 25V	"		
C224	UW 83 74 70	"	47µF 16V	"		
C225	FG 44 44 70	Ceramic Capacitor	0.047µF 50V(Z)	セラコン		
C226	UW 86 61 00	Electrolytic Capacitor	1µF 50V	ケミコン		
C227	UW 91 74 70	"	47µF 6.3V	"		
* C228	UW 95 71 00	"	10µF 35V	"		
C229	FG 44 41 00	Ceramic Capacitor	0.01µF 50V(Z)	セラコン		
C232	FG 44 41 00	Ceramic Capacitor	0.01µF 50V(Z)	セラコン		
C233	FG 44 41 00	Ceramic Capacitor	0.01µF 50V(Z)	セラコン		
* L101	GE 90 03 30	Ferrite Shield Type Choke Coil	220µH	フェライトシールドタイプ チョークコイル		
C101	HJ 35 51 50	Carbon Resistor	150Ω RD25	カーボン抵抗		
R102	HJ 35 51 50	Carbon Resistor	150Ω RD25	カーボン抵抗		
R103	HJ 35 73 30	"	33KΩ "	"		
R104	HJ 35 73 30	"	33KΩ "	"		
R105	HJ 35 71 80	"	18KΩ "	"		
R106	HJ 35 71 80	"	18KΩ "	"		
* R111	HL 71 81 20	Metal Oxide Film Resistor	1.2KΩ 1P	酸化抵抗フォーミング		
R112	HJ 35 51 00	Carbon Resistor	100Ω RD25	カーボン抵抗		
R113	HJ 35 51 00	Carbon Resistor	100Ω RD25	カーボン抵抗		
R114	HJ 35 55 60	"	560Ω "	"		
R115	HJ 35 55 60	"	560Ω "	"		
* R121	HU 57 34 70	Metal Film Resistor	4.7Ω SN14K2E(F)	金属被膜抵抗		
R122	HU 57 34 70	Metal Film Resistor	4.7Ω SN14K2E(F)	金属被膜抵抗		
R123	HU 57 51 20	"	120Ω "	"		
R124	HU 57 51 20	"	120Ω "	"		
* R131	HJ 35 64 70	Carbon Resistor	4.7KΩ RD25	カーボン抵抗		
R132	HJ 35 64 70	Carbon Resistor	4.7KΩ RD25	カーボン抵抗		
R133	HJ 35 61 80	"	1.8KΩ "	"		
R134	HJ 35 61 80	"	1.8KΩ "	"		
R135	HJ 35 72 20	"	22KΩ "	"		
R136	HJ 35 72 20	"	22KΩ "	"		
R137	HJ 35 64 70	"	4.7KΩ "	"		
R138	HJ 35 64 70	"	4.7KΩ "	"		
R139	HJ 35 61 00	"	1KΩ "	"		
R140	HJ 35 61 00	"	1KΩ "	"		
R141	HJ 35 43 90	"	39Ω "	"		
R142	HJ 35 43 90	"	39Ω "	"		
R143	HJ 35 45 60	"	56Ω "	"		
R144	HJ 35 45 60	"	56Ω "	"		
R145	HJ 35 45 60	"	56Ω "	"		
R146	HJ 35 45 60	"	56Ω "	"		
R147	HJ 35 45 60	"	56Ω "	"		
R148	HJ 35 45 60	"	56Ω "	"		
R149	HJ 35 45 60	"	56Ω "	"		
R150	HV 35 41 50	Flame Proof Carbon Resistor	15Ω RDF25SF	不燃化カーボン抵抗		
R151	HV 35 41 50	Flame Proof Carbon Resistor	15Ω RDF25SF	不燃化カーボン抵抗		
R152	HJ 35 65 60	Carbon Resistor	5.6KΩ RD25	カーボン抵抗		
R153	HJ 35 65 60	Carbon Resistor	5.6KΩ RD25	カーボン抵抗		
R154	HJ 35 65 60	Carbon Resistor	5.6KΩ RD25	カーボン抵抗		
R155	HJ 35 65 60	Carbon Resistor	5.6KΩ RD25	カーボン抵抗		
R156	HJ 35 65 60	Carbon Resistor	5.6KΩ RD25	カーボン抵抗		
R157	HJ 35 65 60	Carbon Resistor	5.6KΩ RD25	カーボン抵抗		
R158	HJ 35 65 60	Carbon Resistor	5.6KΩ RD25	カーボン抵抗		
R159	HJ 35 65 60	Carbon Resistor	5.6KΩ RD25	カーボン抵抗		
R160	HJ 35 65 60	Carbon Resistor	5.6KΩ RD25	カーボン抵抗		
R161	HJ 35 72 70	Carbon Resistor	27KΩ RD25	カーボン抵抗		
R162	HJ 35 72 70	Carbon Resistor	27KΩ RD25	カーボン抵抗		
R163	HJ 35 81 00	"	100KΩ "	"		
R164	HJ 35 81 00	"	100KΩ "	"		
R165	HJ 35 81 00	"	100KΩ "	"		
R166	HJ 35 81 00	"	100KΩ "	"		
R167	HJ 35 92 20	"	2.2MΩ "	"		
R168	HJ 35 92 20	"	2.2MΩ "	"		
R169	HJ 35 51 00	"	100Ω "	"		
R170	HJ 35 51 00	"	100Ω "	"		
R171	HJ 35 51 00	"	100Ω "	"		
R172	HJ 35 51 00	"	100Ω "	"		
R173	HJ 35 55 60	"	560Ω "	"		
R174	HJ 35 55 60	"	560Ω "	"		
R175	HJ 35 55 60	"	560Ω "	"		
R176	HJ 35 55 60	"	560Ω "	"		
R177	HJ 35 52 20	"	220Ω "	"		
R178	HJ 35 52 20	"	220Ω "	"		
R179	HJ 35 74 70	"	47KΩ "	"		
R180	HJ 35 74 70	"	47KΩ "	"		
R181	HJ 35 51 80	"	180Ω "	"		
R182	HJ 35 51 80	"	180Ω "	"		
R183	HJ 35 62 20	"	2.2KΩ "	"		
R184	HJ 35 62 20	"	2.2KΩ "	"		
R185	HJ 35 62 20	"	2.2KΩ "	"		
R186	HJ 35 62 20	"	2.2KΩ "	"		
R187	HJ 35 43 30	"	33Ω "	"		
R188	HJ 35 43 30	"	33Ω "	"		
R189	HJ 35 51 50	"	150Ω "	"		
R190	HJ 35 51 50	"	150Ω "	"		
R191	HJ 35 51 50	"	150Ω "	"		
R192	HJ 35 51 50	"	150Ω "	"		
R193	HJ 35 51 80	"	180Ω "	"		
R194	HJ 35 51 80	"	180Ω "	"		
R195	HJ 35 51 80	"	180Ω "	"		
R196	HJ 35 51 80	"	180Ω "	"		
R197	HJ 35 81 50	"	150KΩ "	"		
R198	HJ 35 81 50	"	150KΩ "	"		
R199	HJ 35 81 50	"	150KΩ "	"		
R200	HJ 35 81 50	"	150KΩ "	"		
R201	HJ 35 83 90	"	3.9KΩ "	"		
R202	HJ 35 83 90	"	3.9KΩ "	"		
R203	HJ 35 51 00	"	100Ω "	"		
R204	HJ 35 51 00	"	100Ω "	"		
R205	HJ 35 51 00	"	100Ω "	"		
R206	HJ 35 51 00	"	100Ω "	"		
R207	HJ 35 51 20	"	120Ω "	"		
R208	HJ 35 51 20	"	120Ω "	"		
R209	HJ 35 51 20	"	120Ω "	"		
R210	HJ 35 51 20	"	120Ω "	"		
R211	HJ 35 81 00	"	1KΩ "	"		
R212	HJ 35 81 0					

Ref. No.	Part No.	Description	(部 品 名)	Remarks	Common model	Markets
R223 R224	HJ 35 51 00	Carbon Resistor	100Ω RD25	カーボン抵抗		
R225 R226	HU 57 64 30	Metal Film Resistor	4.3KΩ SN14K2E(F)	金属被膜抵抗		
R227 R228	HU 57 75 10	"	51KΩ "	"		
R229 R230	HU 57 64 70	"	4.7KΩ "	"		
R239 R240	HJ 35 53 30	Carbon Resistor	330Ω RD25	カーボン抵抗		
R241 R242	HJ 35 81 00	"	100KΩ "	"		
R243 R246	HJ 35 71 00	"	10KΩ "	"		
R247 R250	HJ 35 91 00	"	1MΩ "	"		
R251 R252	HJ 35 52 20	"	220Ω "	"		
R253 R254	HZ 00 25 20	Metal Film Resistor	1.5KΩ SN14K2E(F)	デュアル金属被膜抵抗		
R257 R258	HJ 35 44 70	Carbon Resistor	47Ω RD25	カーボン抵抗		
* R259 R262	HU 57 42 70	Metal Film Resistor	27Ω SN14K2E(F)	金属被膜抵抗		
R263 R266	HJ 35 73 30	Carbon Resistor	33KΩ RD25	カーボン抵抗		
R267 R268	HJ 35 71 80	"	18KΩ "	"		
R269 R270	HJ 35 54 70	"	470Ω "	"		
R271 R272	HJ 35 73 90	"	39KΩ "	"		
R273 R274	HJ 35 61 00	"	1KΩ "	"		
R275 R276	HJ 35 66 80	"	6.8KΩ "	"		
R277 R278	HU 57 52 70	Metal Film Resistor	270Ω SN14K2E(F)	金属被膜抵抗		
R279 R280	HJ 35 52 20	Carbon Resistor	220Ω RD25	カーボン抵抗		
R281 R282	HJ 35 65 60	"	5.6KΩ "	"		
R283 R284	HJ 35 64 70	"	4.7KΩ "	"		
R285 R288	HJ 35 51 20	"	120Ω "	"		
R289 R290	HJ 35 56 80	"	680Ω "	"		
R291 R292	HJ 35 62 70	"	2.7KΩ "	"		
R293 R296	HJ 35 52 20	"	220Ω "	"		
R297 R298	HJ 35 51 50	"	150Ω "	"		
R300	HJ 35 51 00	Carbon Resistor	100Ω RD25	カーボン抵抗		
R301 R302	HJ 35 61 20	"	1.2KΩ "	"		
R303 R304	HJ 35 71 00	"	10KΩ "	"		
R313 R318	HJ 35 71 00	Carbon Resistor	10KΩ RD25	カーボン抵抗		
R319 R324	HJ 35 81 00	"	100KΩ "	"		
R325 R330	HJ 35 74 70	"	47KΩ "	"		
R331 R336	HJ 35 81 00	"	100KΩ "	"		
R337 R344	HJ 35 71 00	"	10KΩ "	"		
R345 R346	HJ 35 74 70	"	47KΩ "	"		
R347 R348	HJ 35 63 30	"	3.3KΩ "	"		
R349 R350	HJ 35 72 20	"	22KΩ "	"		
R351 R352	HJ 35 61 20	"	1.2KΩ "	"		
R353 R356	HJ 35 61 00	"	1KΩ "	"		
R357 R358	HJ 35 58 20	"	820Ω "	"		
* R359 R361	HL 73 52 70	Metal Oxide Film Resistor	270Ω 3P	酸金抵抗フォーミング		
* R362	HL 71 61 80	"	1.8KΩ 1P	"		
R363	HJ 35 54 70	Carbon Resistor	470Ω RD25	カーボン抵抗		
R364	HJ 35 61 00	"	1K "	"		
R366	HL 72 51 50	Metal Oxide Film Resistor	150Ω 2P	酸金抵抗フォーミング		

* : New Parts (新部品)

Ref. No.	Part No.	Description	(部 品 名)	Remarks	Common model	Markets
R367	HJ:35:75:60	Carbon Resistor	56K Ω RD25	カーボン抵抗		
R368	HJ:35:71:50	"	15K Ω "	"		
R369	HJ:35:63:30	"	3.3K Ω "	"		
R370	HJ:35:82:20	"	220K Ω "	"		
R371 R372	HJ:35:64:70	"	4.7K Ω "	"		
R373	HJ:35:72:20	"	22K Ω "	"		
R374	HJ:35:74:70	"	47K Ω "	"		
R375	HJ:35:71:20	"	12K Ω "	"		
R377 R378	HJ:35:91:00	"	1M Ω "	"		
* R379 ~382	HU:57:31:00	Metal Film Resistor	1 Ω SN14K2E(F)	金属被膜抵抗		
R387 R388	HJ:35:91:00	Carbon Resistor	1M Ω RD25	カーボン抵抗		
R393 ~396	HV:35:42:20	Flame Proof Carbon Resistor	22 Ω RDF25SF	不燃化カーボン抵抗		
VR101 VR102	HY:00:09:60	Semi Variable Resistor	B100 Ω	半固定ボリューム		
* VR103 VR104	HT:18:02:40	"	B500 Ω TM8KHI-IS	メタルグレースVR		
* VR105	HS:41:15:40	Variable Resistor	20K Ω MN \times 2	ボリューム1軸2連	(BALANCE)	
* VR106	HY:00:14:10	"	50K Ω 特 \times 2 +10K Ω 特 \times 2	" ミニディテント	(VOLUME)	
TR101 TR102	iD:07:86:00	Transistor	2SD786(Q,R,S)	トランジスタ		
TR103 TR104	iB:07:37:00	"	2SB737(Q,R,S)	"		
TR105 TR106	iC:12:13:10	"	2SC1213A(C,D)	"	} Inter- changeable (併用)	
"	iC:18:15:80	"	2SC1815(Y,GR)	"		
TR107 TR108	iA:06:73:10	"	2SA673A(C,D)	"	} Inter- changeable (併用)	
"	iA:10:15:30	"	2SA1015(Y,GR)	"		
TR109 TR110	iC:17:40:00	"	2SC1740(R,S)	"	} Inter- changeable (併用)	
"	iC:23:20:10	"	2SC2320(E,F)	"		
* "	iC:26:34:00	"	2SC2634(R,S,T)	"		
TR111 TR112	iA:09:33:00	"	2SA933(Q,R)	"	} Inter- changeable (併用)	
"	iA:09:99:10	"	2SA999(E,F)	"		
* "	iA:11:27:00	"	2SA1127(R,S,T)	"		
TR114	iC:12:13:10	"	2SC1213A(C,D)	"	} Inter- changeable (併用)	
"	iC:18:15:80	"	2SC1815(Y,GR)	"		
TR116	iA:06:73:10	"	2SA673A(C,D)	"	} Inter- changeable (併用)	
"	iA:10:15:30	"	2SA1015(Y,GR)	"		
* TR117 TR118	iE:20:05:10	Dual FET	2SJ75(GR,BL)	デュアルFET		
TR119 TR120	iC:17:40:00	Transistor	2SC1740(R,S)	トランジスタ	} Inter- changeable (併用)	
"	iC:23:20:10	"	2SC2320(E,F)	"		
* "	iC:26:34:00	"	2SC2634(R,S,T)	"		
TR121 TR122	iC:12:13:10	"	2SC1213A(C,D)	"	} Inter- changeable (併用)	
"	iC:18:15:80	"	2SC1815(Y,GR)	"		
TR123 TR124	iA:06:73:10	"	2SA673A(C,D)	"	} Inter- changeable (併用)	
"	iA:10:15:30	"	2SA1015(Y,GR)	"		
TR125 TR126	iC:12:13:10	"	2SC1213A(C,D)	"	} Inter- changeable (併用)	
"	iC:18:15:80	"	2SC1815(Y,GR)	"		
TR127 TR128	iC:17:40:00	"	2SC1740(R,S)	"	} Inter- changeable (併用)	
"	iC:23:20:10	"	2SC2320(E,F)	"		
* "	iC:26:34:00	"	2SC2634(R,S,T)	"		

* : New Parts (新部品)

Ref. No.	Part No.	Description	(部 品 名)	Remarks	Common model	Markets
TR129 TR130	iA 09:33:00	Transistor	2SA933(Q,R)	トランジスタ	Inter-changeable (併用)	
"	iA 09:99:10	"	2SA999(E,F)	"		
"	iA 11:27:00	"	2SA1127(R,R,T)	"		
TR131 TR132	iD 04:38:10	"	2SD438(E,F)	"	Inter-changeable (併用)	
TR133 TR134	iB 05:60:10	"	2SB560(E,F)	"		
TR139 -142	iC 17:40:00	"	2SC1740(R,S)	"		
"	iC 23:20:10	"	2SC2320(E,F)	"	Inter-changeable (併用)	
"	iC 26:34:00	"	2SC2634(R,S,T)	"		
TR143 TR144	iE 10:19:10	Dual FET	μ PA68H(L,M)	デュアルFET		
TR145 TR146	iZ 00:02:00	Twin Transistor	2SC1815(O,Y)	ツイントランジスタ		
TR149 TR150	iZ 00:01:20	Dual Transistor	μ PA74V	デュアルトランジスタ		
TR151 -154	iA 06:73:10	Transistor	2SA673A(C,D)	トランジスタ		
"	iA 10:15:30	"	2SA1015(Y,GR)	"		
TR155 TR156	iC 27:05:00	"	2SC2705(O,Y)	"		
TR161 -166	iC 23:24:00	Transistor	2SC2324K	トランジスタ	Inter-changeable (併用)	
"	iD 05:49:00	"	2SD549YH(35V)	"		
TR167 TR168	iC 23:20:10	"	2SC2320(E,F)	"		
TR169 TR170	iA 09:99:10	"	2SA999(E,F)	"		
TR171	iC 09:82:00	"	2SC982	"		
TR172	iC 19:83:00	"	2SC1983	"	Inter-changeable (併用)	
"	iD 10:52:10	"	2SD1052A	"		
TR173	iA 09:33:00	"	2SA933(Q,R)	"	Inter-changeable (併用)	
"	iA 09:99:10	"	2SA999(E,F)	"		
"	iA 11:27:00	"	2SA1127(R,S,T)	"		
TR174	iC 17:40:00	"	2SC1740(R,S)	"	Inter-changeable (併用)	
"	iC 23:20:10	"	2SC2320(E,F)	"		
"	iC 26:34:00	"	2SC2634(R,S,T)	"		
TR175 TR176	iZ 00:01:30	Dual Transistor	μ PA75V	デュアルトランジスタ		
D101 -104	iF 00:00:40	Diode	IS1555	ダイオード	Inter-changeable (併用)	
"	iF 00:06:70	"	IS2473	"		
D105 D106	iF 00:14:10	Zener Diode	HZ-9B	ツェナーダイオード		
D107 -110	iF 00:00:40	Diode	IS1555	ダイオード	Inter-changeable (併用)	
"	iF 00:06:70	"	IS2473	"		
D111	iH 00:07:10	"	W06C	"		
D113 -116	iF 00:00:40	Diode	IS1555	ダイオード	Inter-changeable (併用)	
"	iF 00:06:70	"	IS2473	"		
D121 D122	iF 00:15:10	Zener Diode	HZ-6CIL	ツェナーダイオード		
D123 D124	iF 00:10:70	"	HZ6B	"		
D125 D126	iF 00:00:40	Diode	IC1555	ダイオード	Inter-changeable (併用)	
"	iF 00:06:70	"	IS2473	"		
D131	iF 00:00:40	Diode	IS1555	ダイオード	Inter-changeable (併用)	
"	iF 00:06:70	"	IS2473	"		

* : New Parts (新部品)

Ret. No.	Part No.	Description	(部 品 名)	Remarks	Common model	Markets
D132 ~137	iF 00 16 20	Diode	IS2076A	ダイオード		
D138 D139	iF 00 05 50	Zener Diode	HZ12C	ツェナーダイオード		
D140 D141	iF 00 16 20	Diode	IS2076A	ダイオード		
D142 ~144	iF 00 00 40	"	IS1555	"	Inter- changeable (併用)	
"	iF 00 06 70	"	IS2473	"		
D145	iF 00 16 20	"	IS2076A	"		
* D146	iF 00 37 30	Zener Diode	HZ-33-1	ツェナーダイオード		
D147	iH 00 07 10	Diode	W06C	ダイオード		
D148	iF 00 00 40	"	IS1555	"	}	
"	iF 00 06 70	"	IS2473	"		
* D149	iF 00 34 80	Zener Diode	HZ3C1	ツェナーダイオード		
D150	iF 00 16 20	Diode	IS2076A	ダイオード		
* D151 D152	iF 00 18 40	Zener Diode	RD3.OEB2	ツェナーダイオード		
* IC101	iG 05 82 00	IC	M5218L	IC		
IC102 IC103	iG 00 11 70	"	TC4001P	"		
IC104	iG 00 11 80	"	TC4013P	"		
* SW101	KA 90 28 40	Remote Push Switch S	2-2	リモートプッシュスイッチ		
* SW103	KA 90 28 70	Remote Rotary Switch NS	4-6	リモートルォタリースイッチ		
* SW104	KA 90 27 90	Solenoid Switch NS	4-2	ソレノイドスイッチ6連動		
SW102	KA 90 32 20	Remote Rotary Switch NS	4-6	リモートルォタリースイッチ		
* RY101 ~104	KC 00 12 90	Relay	HB2E 24V	リレー		
PJ101	LB 20 19 50	Pin Jack	2P	ピンジャック		
* "	LB 20 19 80	"	2P	"		
* PJ102	LB 40 09 70	"	4P	"		
"	LB 40 09 30	"	4P	"		
PJ103	LB 60 42 20	"	6P	"		
* PJ104 PJ105	LB 40 09 80	"	4P	"		
LA 00 21 10	Wrapping Terminal i-Type	P=5 2P	i型ラッピング端子板			
LA 00 23 20	"	P=7.5 3P	"			
LA 00 25 40	"	P=5(0) 2P	"			
LA 00 41 20	Test Point Pin		テストポイントピン			
LB 00 30 30	Socket	3P	ジャンパーソケット			
LB 00 30 40	"	4P	"			
* LB 00 30 60	"	6P	"			
* LB 00 30 70	"	7P	"			
* MI 07 05 20	Cable	ℓ=140 5P	パラレルケーブル			
LB 90 40 50	Connector Plug L Type	M34-05-03-134P 5P	コネクタプラグ			
LB 90 40 60	"	M34-06-03-134P 6P	"			
BB 06 97 30	Shield Plate		シールド板		C-70	
CB 60 78 40	VCP Cap	VCP-8(Black)	VCPキャップ		C-70	
BA 07 72 90	Heat Sink		放熱板			
EN 33 00 10	Bind Head Tapping Screw	3×8 FCM3-Bℓ	鉄バインドタッピングネジ 2種ミソ			
BB 06 83 70	Metal Fitting		アース金具		A-550	

* : New Parts (新部品)

Ref. No.	Part No.	Description	(部 品 名)	Remarks	Common model	Markets
*	NA 07 84 60	Tone Control Circuit Board	トーンコントロールシート			R
*	NA 07 84 70	"	"			U, C
*	NA 07 84 80	"	"			A, G, B
C401 C402	UW 96 64 70	Electrolytic Capacitor	4.7 μ F 50V	ケミコン		
C403 C404	FU 35 11 00	Mica Capacitor FE	10pF 500V(J)	マイカコン		
C405 C406	FG 41 12 20	Ceramic Capacitor	22pF 50V(K)	セラコン		
C407 C408	FT 51 22 20	Polypropylene Capaeitor NP	220pF 50V(K)	ポリプロコン		
C409 C410	FG 41 12 20	Ceramic Capacitor	22pF 50V(K)	セラコン		
C411 ~414	UW 91 74 70	Electrolytic Capacitor	47 μ F 6.3V	ケミコン		
C415 C416	UW 96 71 00	"	10 μ F 50V	"		
C417 ~420	UW 91 74 70	"	47 μ F 6.3V	"		
C421 C422	UA 25 51 50	Mylar Capacitor	0.15 μ F 50V(J)	マイラーコン		
C423 C424	UA 25 31 50	"	0.0025 μ F "	"		
C425 C426	UW 91 74 70	Electrolytic Capacitor	47 μ F 6.3V	ケミコン		
C427 C428	UW 95 73 30	"	33 μ F 35V	"		
C429 ~432	UA 25 51 00	Mylar Capacitor	0.1 μ F 50V(J)	マイラーコン		
C433 C434	FT 51 21 00	Polypropylene Capacitor NP	100pF 50V(K)	ポリプロコン		
C439 C440	FA 15 31 00	Mylar Capacitor	0.001 μ F 50V(J)	マイラーコン		
C441 C442	UA 25 31 00	"	"	"		
C443 C444	FU 35 12 70	Mica Capacitor FE	27pF 500V(J)	マイカコン		
C445 C446	FU 35 13 30	" FE	33pF "	"		
C447 C448	UA 25 31 00	Mylar Capacitor	0.001 μ F 50V(K)	マイラーコン		
C451 C452	UW 96 61 00	Electrolytic Capacitor	1 μ F 50V	ケミコン		
C453 C454	FU 35 12 20	Mica Capacitor FE	22pF 500V(J)	マイカコン		
C459 C460	UA 25 31 00	Mylar Capacitor	0.001 μ F 50V(J)	マイラーコン		
C461 C462	UW 86 71 00	Electrolytic Capacitor	10 μ F 50V	ケミコン		
C463	UA 25 31 50	Mylar Capacitor	0.0015 μ F 50V(J)	マイラーコン		
C464	FG 44 41 00	Ceramic Capacitor	0.01 μ F 50V(Z)	セラコン		
C465 C466	UW 91 74 70	Electrolytic Capacitor	47 μ F 6.3V	ケミコン		
C467 C468	FG 41 21 00	Ceramic Capacitor	100pF 50V(K)	セラコン		
C469 C470	FU 35 13 30	Mica Capacitor FE	33pF 500V(J)	マイカコン		
C471 C472	UW 95 82 20	Electrolytic Capacitor	220 μ F 35V	ケミコン		
C473	UW 95 74 70	"	47 μ F 35V	"		
C475	FC 28 41 00	Polypropylene Capacitor QP	0.01 μ F 250V(J)	ポリプロコン		
C476	FG 41 15 60	Ceramic Capacitor	56pF 50V(K)	セラコン		
C477 C478	UW 86 71 00	Electrolytic Capacitor	10 μ F 50V	ケミコン		
C479 C480	UW 96 91 00	"	100 μ F 50V	"		
C481 C482	UA 55 51 00	Mylar Capacitor	0.1 μ F 50V(J)	マイラーコン		
C483 ~488	UW 86 71 00	Electrolytic Capacitor	10 μ F 50V	ケミコン		
C489	UW 95 74 70	"	47 μ F 35V	"		
C490	UW 86 71 00	"	10 μ F 50V	"		
C491	UW 96 71 00	"	10 μ F 50V	"		
C492	FG 44 44 70	Ceramic Capacitor	0.047 μ F 50V(Z)	セラコン		
C493	FG 44 41 00	"	0.01 μ F 50V(Z)	"		
C494	UA 55 54 70	Mylar Capacitor	0.47 μ F 50V(J)	マイラーコン		
C497 C498	FG 44 41 00	Ceramic Capacitor	0.01 μ F 50V(Z)	セラコン		

* : New Parts (新部品)

Ref. No.	Part No.	Description	(部 品 名)	Remarks	Common model	Markets
R401 R402	HJ 35 81 00	Carbon Resistor	100K Ω RD25	カーボン抵抗		
R403 R404	HJ 35 85 60	"	560K Ω "	"		
R405 -408	HJ 35 71 50	"	15K Ω "	"		
R409 R410	HJ 35 61 00	"	1K Ω "	"		
R411 -414	HJ 35 71 50	"	15K Ω "	"		
R415 R416	HJ 35 52 20	"	220 Ω "	"		
R417 R418	HJ 35 81 00	"	100K Ω "	"		
R419 -426	HJ 35 66 80	"	6.8K Ω "	"		
R427 R428	HJ 35 91 00	"	1M Ω "	"		
R429 R430	HJ 35 73 30	"	33K Ω "	"		
R431 R432	HJ 35 76 80	"	68K Ω "	"		
R433 R434	HJ 35 51 00	"	100 Ω "	"		
R435 R436	HJ 35 81 50	"	150K Ω "	"		
R439 R440	HZ 00 25 10	Metal Film Resistor	1.5K Ω SN14K2E	金属被膜抵抗		
R443 -446	HU 57 52 20	"	220 Ω "	"		
R447 R448	HJ 35 54 70	Carbon Resistor	470 Ω RD25	カーボン抵抗		
* R449 R450	HL 71 58 20	Metal Oxide Film Resistor	820 Ω 1P	酸化抵抗フォーミング		
R453 R454	HJ 35 71 80	"	18K Ω "	"		
R455 R456	HJ 35 73 90	"	39K Ω "	"		
R457 R458	HJ 35 63 30	"	3.3K Ω "	"		
R459 R460	HJ 35 71 00	"	10K Ω "	"		
R461 R462	HJ 35 63 30	Carbon Resistor	3.3K Ω RD25	カーボン抵抗		
* R463 R464	HL 71 63 90	Metal Oxide Film Resistor	3.9K Ω 1P	酸化抵抗フォーミング		
R465 R466	HJ 35 52 20	Carbon Resistor	220 Ω RD25	カーボン抵抗		
R467 -470	HU 57 54 70	Metal Film Resistor	470 Ω SN14K2E	金属被膜抵抗		
R471 -474	HJ 35 51 80	Carbon Resistor	180 Ω RD25	カーボン抵抗		
R475 -478	HJ 35 45 60	"	56 Ω "	"		
R479 -482	HJ 35 52 20	"	220 Ω "	"		
R487 R488	HJ 35 44 70	Carbon Resistor	47 Ω RD25	カーボン抵抗		
R493 R494	HJ 35 71 00	"	10K Ω "	"		
R495 R496	HJ 35 72 20	"	22K Ω "	"		
R497 R498	HJ 35 51 00	"	100 Ω "	"		
R499 R500	HJ 35 71 00	"	10K Ω "	"		
* R501	HL 83 56 80	Metal Oxide Film Resistor	680 Ω 3P	酸化抵抗ストレート		
R502 -504	HJ 35 81 00	Carbon Resistor	100K Ω RD25	カーボン抵抗		
R505 R506	HJ 35 61 00	"	1K Ω "	"		
R507 R508	HJ 35 64 70	"	4.7K Ω "	"		
R509 R510	HJ 35 54 70	"	470 Ω "	"		
R511 R512	HJ 35 66 80	"	6.8K Ω "	"		
R513 -516	HJ 35 42 20	"	22 Ω "	"		
* R517 R518	HL 72 46 80	Metal Oxide Film Resistor	68 Ω 2P	酸化抵抗フォーミング		
R519 R529	HL 72 53 30	"	330 Ω 2P	"		
R521 R522	HJ 35 61 80	Carbon Resistor	1.8K Ω RD25	カーボン抵抗		
R523 R524	HJ 35 61 00	"	1K Ω "	"		
* R525	HL 72 62 20	Metal Oxide Film Resistor	2.2K Ω 2P	酸化抵抗フォーミング		
R528 R529	HJ 35 52 20	Carbon Resistor	220 Ω RD25	カーボン抵抗		
R530	HJ 35 64 70	"	4.7K Ω "	"		

* : New Parts (新部品)

Ref. No.	Part No.	Description	(部 品 名)	Remarks	Common model	Markets
R531	HJ 35 72 70	Carbon Resistor	27K Ω RD25	カーボン抵抗		
R532	HJ 35 63 90	"	3.9K Ω "	"		
R533	HJ 35 61 50	"	1.5K Ω "	"		
R534	HJ 35 62 70	"	2.7K Ω "	"		
R535	HJ 35 72 20	"	22K Ω "	"		
R536	HJ 35 66 80	"	6.8K Ω "	"		
R537	HJ 35 72 70	"	27K Ω "	"		
R538 R539	HJ 35 64 70	"	4.7K Ω "	"		
R540	HV 35 44 70	Flame Proof Carbon Resistor	47 Ω RDF25SF	不燃化カーボン抵抗		
R541	HJ 35 84 70	Carbon Resistor	470K Ω RD25	カーボン抵抗		
R542 R543	HJ 35 51 00	"	100 Ω "	"		
R545	HJ 35 82 70	"	270K Ω "	"		
R546	HJ 35 63 30	"	3.3K Ω "	"		
※ R547	HL 83 55 60	Metal Oxide Film Resistor	560 Ω 3P	酸化抵抗ストレート		
R553 R554	HJ 35 53 30	Carbon Resistor	330 Ω RD25	カーボン抵抗		
R555 R556	HJ 35 68 20	"	8.2K Ω "	"		
R557 R558	HJ 35 51 00	"	100 Ω "	"		
R559 R560	HJ 35 74 70	"	47K Ω "	"		
R561 R562	HJ 35 68 20	"	8.2K Ω "	"		
R563 R564	HJ 35 73 30	Carbon Resistor	33K Ω RD25	カーボン抵抗		
※ FR401 FR402	HW 59 48 20	Fuse Resistor	82 Ω 1/4W	ヒューズ抵抗		
※ VR401 VR402	HS 41 15 80	Variable Resistor CT,CC	200K Ω 特 \times 2	可変抵抗		
※ VR403 VR404	HS 41 15 90	"	30K Ω 特 \times 2	"		
VR405 VR406	HY 00 10 30	Semi Variable Resistor	TM8KV2-15 B5K Ω	半固定抵抗		
TR401 TR402	iC 22 91 10	Dual Transistor	2SC2291(F,G)	デュアルトランジスタ		
TR405 TR406	iE 10 19 10	Dual FET	μ PA68H(L,M)	デュアルFET		
TR407 TR408	iZ 00 02 00	Twin Transistor	2SC1815(O,Y)	ツイントランジスタ		
TR409 TR410	iZ 00 01 30	Dual Transistor	μ PA75V	デュアルトランジスタ		
TR411 TR412	iZ 00 02 00	Twin Transistor	2SC1815(O,Y)	ツイントランジスタ		
TR413 ~ 416	iA 06 73 10	Transistor	2SA673A(C,D)	トランジスタ	} Inter- changeable (併用)	
"	iA 10 15 30	"	2SA1015(Y,GR)	"		
TR417 TR418	iC 17 40 00	"	2SC1740(R,S)	"	} Inter- changeable (併用)	
"	iC 23 20 10	"	2SC2320(E,F)	"		
※ " "	iC 26 34 00	"	2SC2634(R,S,T)	"		
TR419 TR420	iA 09 99 10	"	2SA999(E,F)	"	} Inter- changeable (併用)	
"	iA 09 33 00	"	2SA933(Q,R)	"		
※ " "	iA 11 27 00	"	2SA1127(R,S,T)	"		
TR423 TR424	iC 27 05 00	"	2SC2075(O,Y)	"		
TR425 TR426	iA 11 45 00	"	2SA1145(O,Y)	"		

※ : New Parts (新部品)

Ref. No.	Part No.	Description	(部 品 名)	Remarks	Common model	Markets
TR431 TR432	iC 04:60:80	Transistor	2SC460(B,C)	トランジスタ		
TR433 TR434	iD 04:38:10	"	2SD438(E,F)	"		
TR435 TR436	iB 05:60:10	"	2SB560(E,F)	"		
※ TR437	iC 09:82:00	"	2SC982	"		
※ TR438 TR439	iE 10:26:10	FET	2SK246(Y)	FET		
※ TR440	iD 08:80:10	Transistor	2SD880(Y,GR)	トランジスタ	} Inter-changeable (併用)	
※ "	iD 03:13:00	"	2SD313(E,F)	"		
TR441	iC 12:13:30	"	2SC1213A(C,D)	"	} Inter-changeable (併用)	
"	iC 18:15:80	"	2SC1815(Y,GR)	"		
TR442	iA 06:73:10	"	2SA673A(C,D)	"	} Inter-changeable (併用)	
"	iA 10:15:30	"	2SA1015(Y,GR)	"		
※ TR443	iD 08:80:10	"	2SD880(Y,GR)	"	} Inter-changeable (併用)	
※ "	iD 03:13:00	"	2SD313(E,F)	"		
TR444 TR445	iC 17:40:00	"	2SC1740(R,S)	"	} Inter-changeable (併用)	
"	iC 18:15:80	"	2SC1815(Y,GR)	"		
TR446	iA 09:99:10	"	2SA999(E,F)	"	} Inter-changeable (併用)	
"	iA 09:33:00	"	2SA933(Q,R)	"		
※ "	iA 11:27:00	"	2SA1127(R,S,T)	"		
※ TR447	iD 06:00:00	"	2SD600(E,F)	"		
TR448	iB 06:31:00	"	2SB631(E,F)	"		
D401 D402	iF 00:00:40	Diode	IS1555	ダイオード	} Inter-changeable (併用)	
"	iF 00:06:70	"	IS2473	"		
D403 D404	iF 00:15:10	Zener Diode	HZ-6CIL	ツェナーダイオード		
D407 D408	iF 00:00:40	Diode	IS1555	ダイオード	} Inter-changeable (併用)	
"	iF 00:06:70	"	IS2473	"		
D409 D410	iF 00:07:90	Varistor Diode	MV12	バリスタ		
D411 ~412	iF 00:15:10	Zener Diode	HZ-6CIL	ツェナーダイオード		
D417 D418	iF 00:07:90	Variator Diode	MV12	バリスタ		
D419	iH 00:07:70	Diode, Bridge	SIRBA	ダイオード、ブリッジ		
D420 D421	iF 00:16:20	Diode	IS2076A	ダイオード	} Inter-changeable (併用)	
"	iH 00:07:10	"	WO6C	"		
D422 ~424	iF 00:00:40	"	IS1555	"	} Inter-changeable (併用)	
"	iF 00:06:70	"	IS2473	"		
D425	iF 00:15:10	Zener Diode	HZ-6CIL	ツェナーダイオード		
D426 D427	iF 00:20:80	"	HZ16L-3	"		
D428	iF 00:25:00	"	HZ-16-2	"		
D429	iF 00:00:40	Diode	IS1555	ダイオード	} Inter-changeable (併用)	
"	iF 00:06:70	"	IS2473	"		
※ IC401 IC402	iG 04:00:00	IC	NJM4560	IC		
※ IC403 IC404	iG 05:82:00	"	M5218L	"		
IC405	iG 04:00:00	"	NJM4560	"		
※ SW401	KA 80:28:20	Push Switch SUN NS	2-2	プッシュスイッチ		
※ SW402 SW403	KA 80:28:30	"	4-2	"		
F401	KB 00:02:10	Fuse	T1.0A 125V	ヒューズタイラッシュ		J
"	KB 00:03:10	"	T0.5A 250V	"		A
"	KB 00:03:30	"	T1.0A 250V	"		R

※ : New Parts (新部品)

Ref. No.	Part No.	Description	(部 品 名)	Remarks	Common model	Markets
F401	KB:00:12:20	Fuse UL ST-4	750mA 250V	ヒューズ		U, C
"	KB:00:06:40	Fuse ⑤	T250mA 250V	ヒューズ⑤タイムラグ		G, B
F402	KB:00:03:10	Fuse	T0.5A 250V	ヒューズタイラッシュ		R
* RY401	KC:00:12:90	Relay	HB2E 24V	リレー		
* PJ401	LB:20:19:80	Pin Jack	2P	ピンジャック		J
"	LB:20:19:50	"	2P	"		R,U,C,G,A,B,
JK401	LB:30:15:20	Headphone Jack		ヘッドホンジャック(黒)		
	LA:00:20:00	Wrapping Terminal	P=7.5 2P	i型ラッピング端子板		
	LA:00:21:40	"	P=10 2P	"		
	LA:00:23:20	"	P=7.5 3P	"		
	LA:00:25:40	"	P=5(0) 2P	"		
	LA:00:25:60	"	P=7.5(0) 2P	"		
	LB:00:30:30		3P	ジャンパーソケット		
* LB:20:19:70		Fuse Holder Pin	23165081	ヒューズホルダーピン		
	LB:20:10:60	"	YSH403T	"		
* Mi:07:00:00		Cable	ℓ=120 2P	バラレルケーブル		
CB:06:92:50		Binding Tie	BK-1	インシュロックタイ		
* Mi:07:01:70		Cable	ℓ=120 3P	バラレルケーブル		
BA:08:24:20		Heat Sink		放熱板	C-70	
BB:06:62:90		Washer		アースワッシャー		
BB:06:83:70		Metal Fitting		アース金具		
EN:33:00:10		Bind Head Tapping Screw	3×8(FCM3-Bℓ)	鉄バインドタッピンネジ 2種ミソ		
ED:82:61:00		Bind Head Screw	M2.6×10	銅バインド小ネジ	A1060	
* EV:30:32:60		Spring Washer	M2.6(FCM3-Bℓ)	スプリングワッシャー		
EV:20:32:60		Flat Washer	M2.6(FCM3-Bℓ)	平ワッシャーミガキ 外径φ6.5		

* : New Parts (新部品)