

TAKE UP ASSY mod
 AA 096931

K-850

SERVICE MANUAL

FRONT PANEL

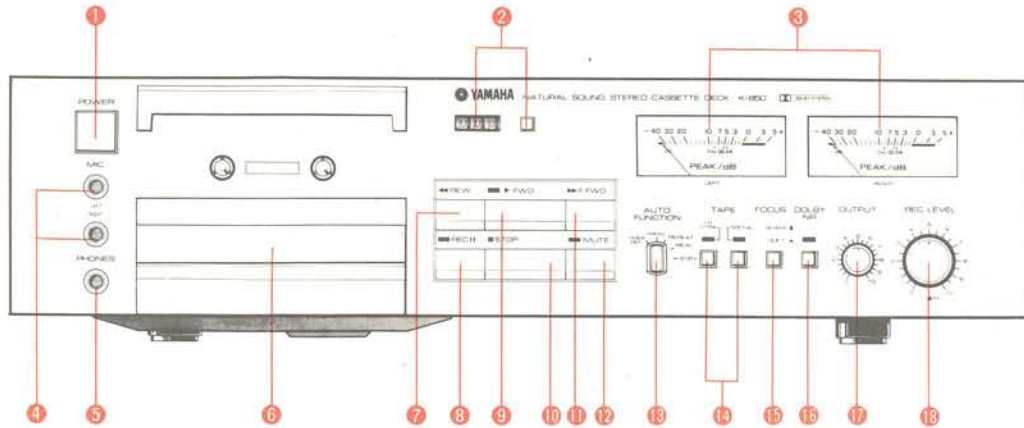

- ① Power Switch (POWER)
- ② Tape Counter/Reset Button
- ③ Peak Level Meters
- ④ Microphone Jacks (MIC)
- ⑤ Headphones Jack (PHONES)
- ⑥ Head Lid
- ⑦ Rewind Button (◀ REW)
- ⑧ Record Standby Button (REC II)
- ⑨ Playback Button (▶ FWD)
- ⑩ Stop Button (■ STOP)
- ⑪ Fast Forward Button (▶▶ F.FWD)
- ⑫ Record Muting Button (MUTE)
- ⑬ Auto Function Selector (AUTO FUNCTION)
- ⑭ Tape Selector Buttons (TAPE)
- ⑮ Focus Button (FOCUS)
- ⑯ Dolby NR Button (DOLBY NR)
- ⑰ Output Level Control (OUTPUT)
- ⑱ Record Level Control (REC LEVEL)

CONTENTS

INTERNAL VIEW	1
DISASSEMBLY PROCEDURE	2
SPECIFICATIONS	3
BLOCK DIAGRAM	3
ADJUSTING POINTS	4
OVERALL ADJUSTMENT	5
IC FUNCTIONAL BLOCK DIAGRAM	8
WIRING	10
SCHEMATIC DIAGRAM	12

004400

INTERNAL VIEW

Bottom View

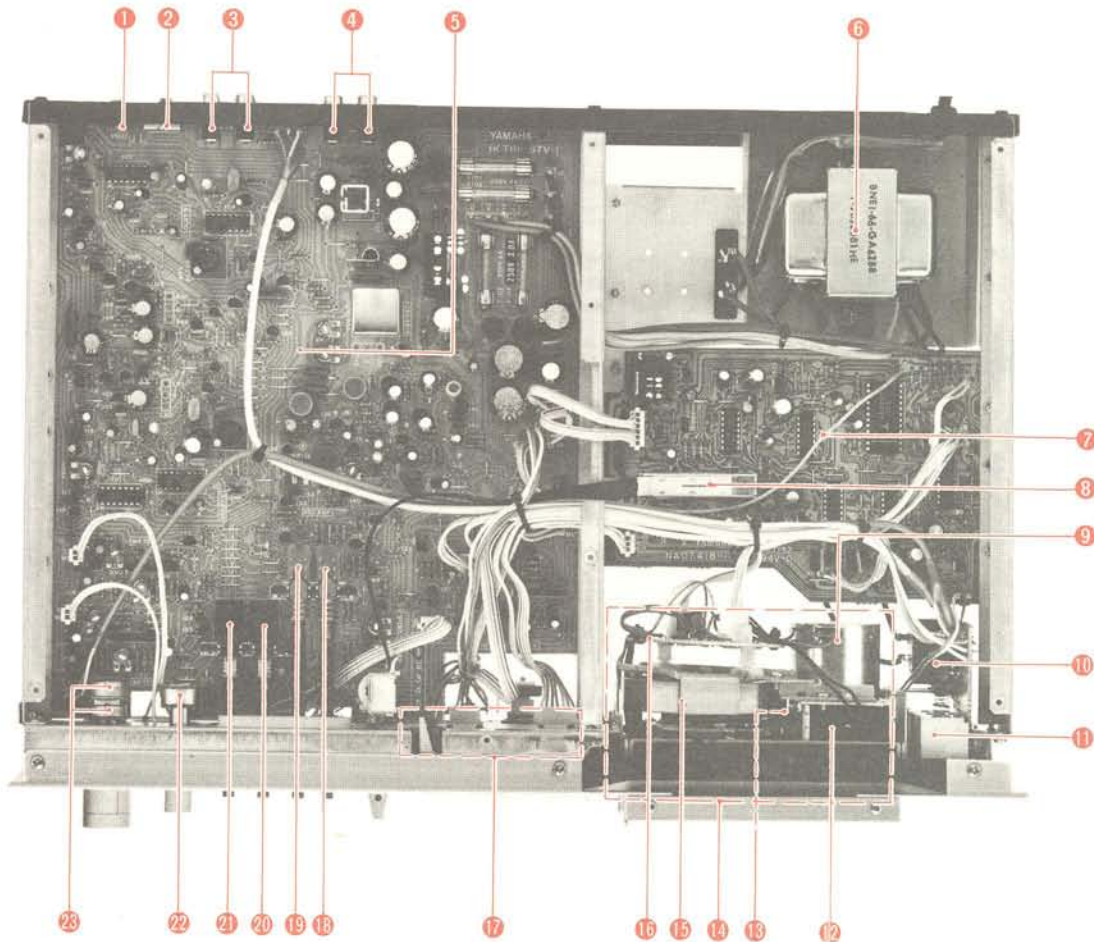

- | | |
|---------------------------------------|---|
| 1 STBY LENGTH ADJ. Knob (VR117) | 12 REW Plunger |
| 2 MPX Filter Switch (SW103) | 13 F.FWD Plunger |
| 3 LINE IN/REC Terminals | 14 Mechanism Assembly TM-3A |
| 4 LINE OUT/PLAY Terminals | 15 Flywheel |
| 5 Main C. Board-1 | 16 Relay C. Board |
| 6 Power Transformer | 17 Keyboard Switch |
| GA62582:U.S. and Canadian Models | 18 TAPE (LH/CrO ₂) Switch (SW102-2) |
| GA62591:N. European Model | 19 TAPE (METAL) Switch (SW102-1) |
| GA62611:Australian and British Models | 20 FOCUS Switch (SW101-2) |
| GA62602:General Model | 21 DOLBY NR Switch (SW101-1) |
| 7 Control C. Board-1 | 22 OUTPUT LEVEL VRs (VR105) |
| 8 AUTO FUNCTION Switch (SW501) | 23 REC LEVEL VRs (VR103, VR104) |
| 9 Motor (JC00060) | |
| 10 Main C. Board-2 | |
| 11 From this side toward other | |
| PHONES Jack (JK403) | |
| MIC Jack-RIGHT (JK402) | |
| MIC Jack-LEFT (JK401) | |

DISASSEMBLY PROCEDURE

1. Removing the Top Cover

Remove screws ① and ② from both sides and then remove the top cover. (See Photo 1)

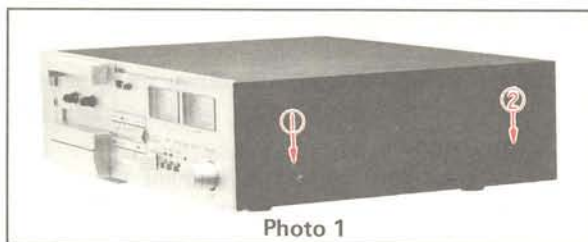

Photo 1

2. Removing the Bottom Cover

Remove tapping screws ① to ⑧ and then remove the bottom cover. (See Photo 2)

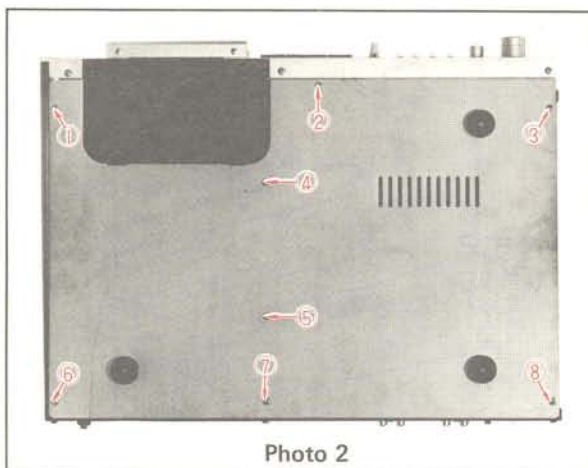

Photo 2

3. Removing the Front Panel

- Remove the top and bottom covers.
- Using a hexagon wrench (1.5) as shown in Photo 5, loosen the hexagon set screws, and pull out the REC LEVEL, AUTO FUNCTION and OUTPUT knobs.

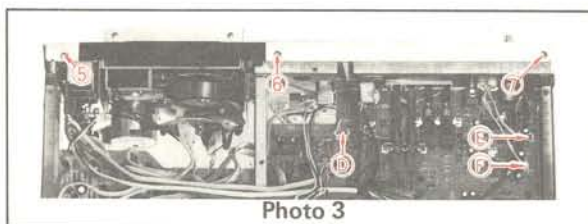

Photo 3

- Pull out the connectors ① (A) and ② (B) as well as the power indicator lamp ③ (C), shown in Photo 4.
- Remove screws ④ (1) to ④ (4) in Photo 4 from under the tape.
- Turn over the main body. Pull out the connectors ④ (D), ⑤ (E) and ⑥ (F) in Photo 3. Also, remove screws ⑤ (5) to ⑦ (7).

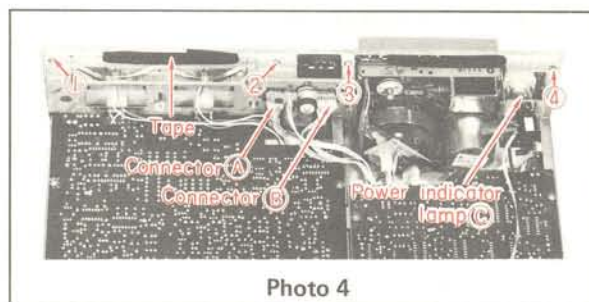

Photo 4

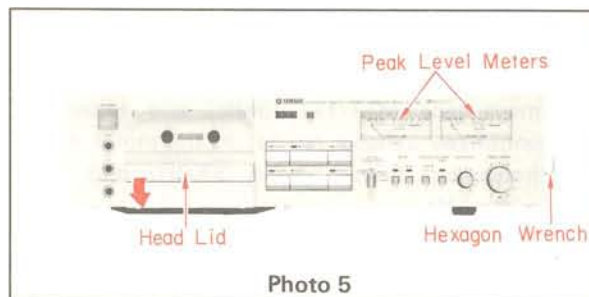

Photo 5

- Open the head lid toward you, and front panel will remove.

4. Removing the mechanism assembly

- Remove the front panel. (Refer to step 3)
- Disconnect the mechanism assembly lead wires at the connector.
- Disengage the tape counter's rubber belt.
- Pull out the three fixing metals of the MIC and PHONES jacks toward the right side. (See Photo 6)
- Remove screws ① (1) to ⑤ (5) shown in Photo 6 and then remove the mechanism assembly.

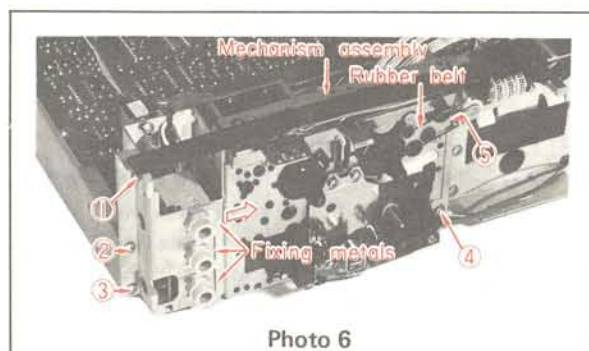

Photo 6

SPECIFICATIONS

Track Configuration 4-track 2-channels
Stereo Cassette Deck

Mechanical Section

Tape Speed 4.8cm/sec±1%
Wow and Flutter 0.04% (JIS,WRMS), 0.15% (DIN)
Rapid Transport (F.FWD/REW) Within 78sec (for C-60 cassette)
Motor DC motor
Operation Logic Controlled Feather Touch Operation
 Full auto shut-off system
Mechanism One Motor, 2 plunger mechanism

Head Section

Recording/Playback Pure Sendust Head
Erase Ferrite Head corresponding to Metal Tape

Amplifier Section

REC/PB Frequency Response (-20VU)
 30 to 16,000Hz ±3dB (for LH tape)
 30 to 18,000Hz ±3dB (for CrO₂ tape)
 30 to 19,000Hz ±3dB (for Metal alloy tape)

Input Sensivity/Impedance MIC: 0.3mV/5kΩ
 LINE: 50mV/100kΩ

Output Level/Impedance

LINE: 340mV/50kΩ (160nWb/m, P.B Vol. MAX)
 PHONE: 4.8mW/150Ω

Dolby NR Effect 9dB, or more
Signal-to-Noise Ratio (CrO₂ tape) better than 52dB (DIN 333Hz
 3% without Dolby)
Overall Distortion Less than 1.0% (for LH tape)
 Less than 1.5% (CrO₂ tape)
 Less than 1.0% (Metal tape)
 (160nWb/m, 1kHz)

General

Semiconductors 2FETs, 74 Transistors, 16 ICs, 33Diodes
U.S. and Canadian Models 120C AC60Hz
North European Model 220V AC50Hz
General Model 110 to 130V/220 to 240V AC50/60Hz
British and Australian Models 240V AC50Hz
Power Consumption 30W
Dimensions 435 x 111.5 x 326.5 mm
 (W x H x D) (17-1/8 x 4-3/8 x 12-7/8")
Weight 6.6kg (14.5 lbs)

Specifications subject to change without notice.

BLOCK DIAGRAM

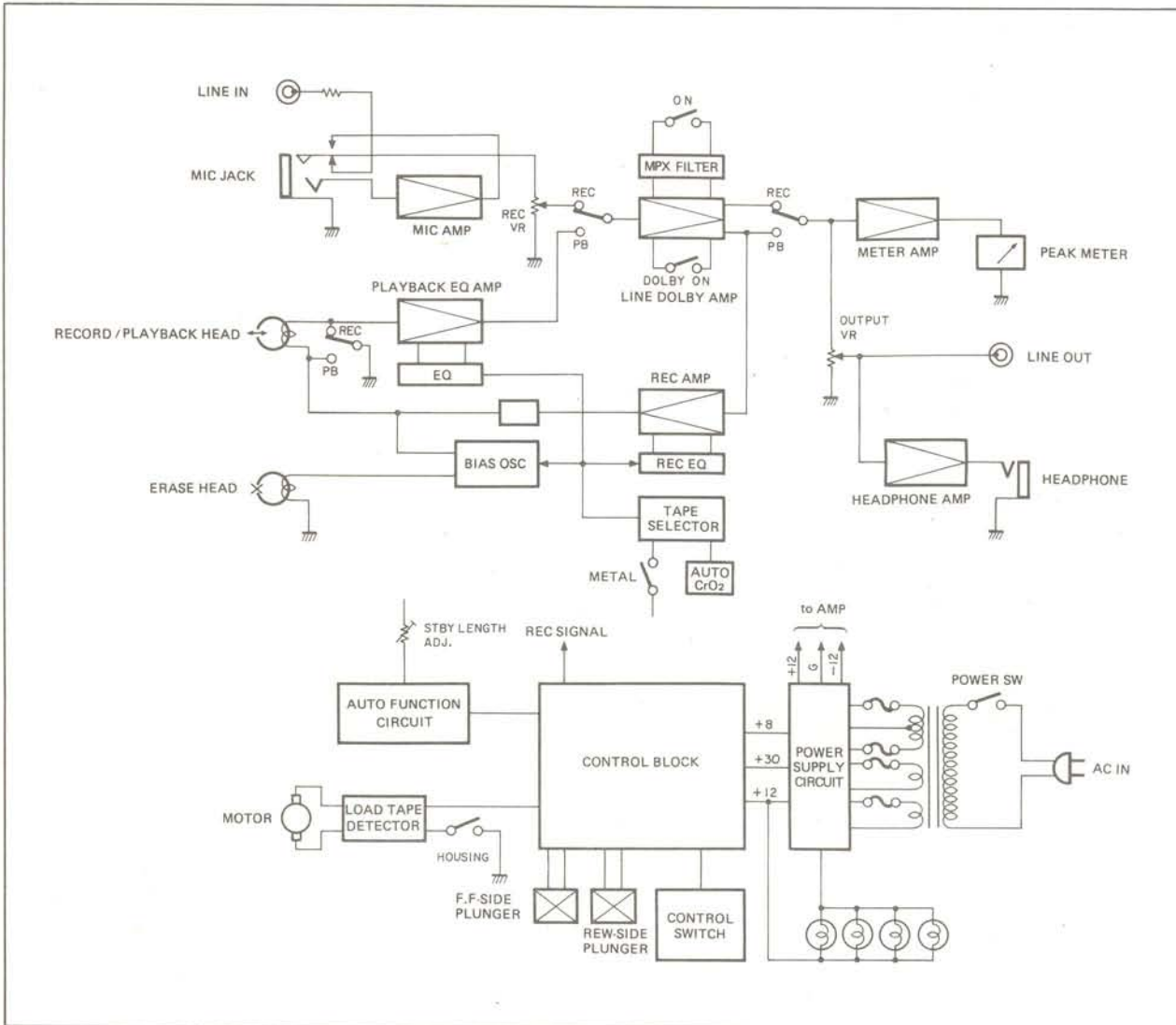

ADJUSTING POINTS

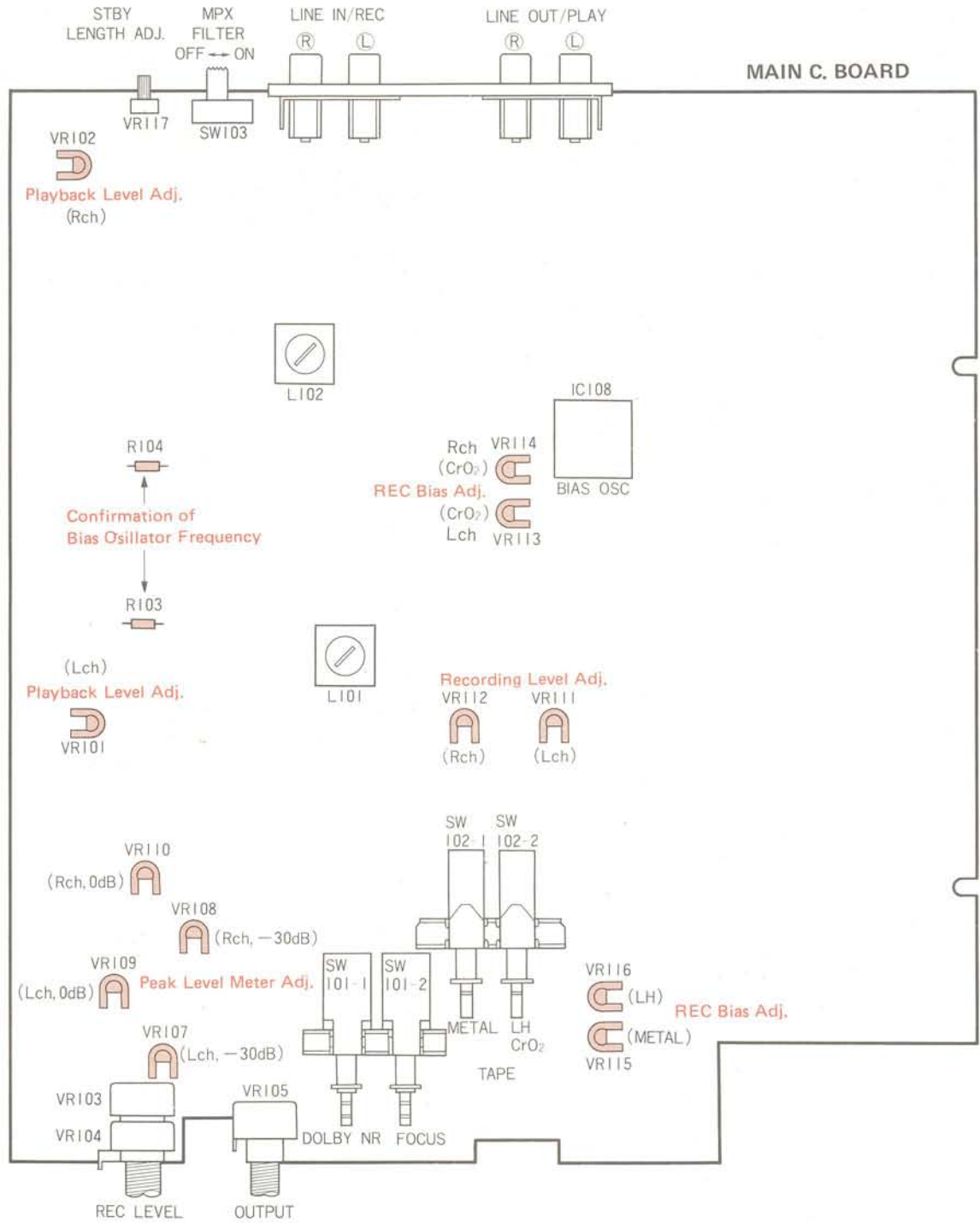

OVERALL ADJUSTMENT

BEFORE ADJUSTMENT;

- 1) Turn off the DOLBY NR switch.
- 2) Do head-erasing and head-cleaning when specially adjusting frequency response and azimuth in order to prevent error caused by magnetization and contamination.

1. ADJUSTMENT OF PLAYBACK RELATION

1-1 Adjustment of Tape Speed

- 1) Connect the frequency counter to the LINE OUT terminals of the left or right channel.
- 2) Set the OUTPUT control at maximum position, play back the center part of the speed adjustment tape MTT-111 (3kHz) and adjust the semi-fixed variable resistor in the motor as the frequency counter shows 3000Hz plus 15Hz minus 5Hz.

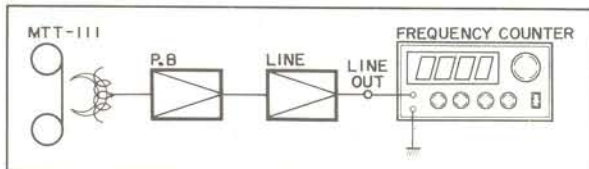
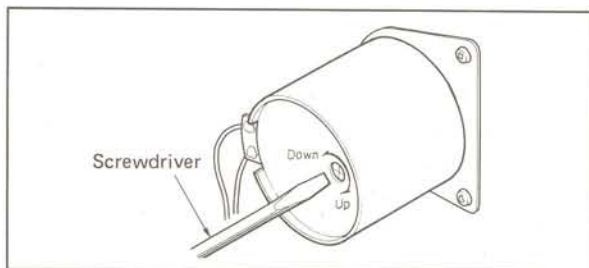

1-2 Adjustment of Playback Level

- 1) Adjust left and right channels by the following procedures.
- 2) Connect the AC voltage meter to the LINE OUT terminal.
- 3) Play back the playback adjustment tape MTT-212C (160nWb/m), set the OUTPUT control at maximum position and adjust VR101 (L-ch) and VR102 (R-ch) so as to obtain -7 ± 1 dBm signal at the LINE OUT terminals.

Note: When using the adjustment tape recorded 250nWb/m (MTT-112), adjust them so as to obtain -3 ± 1 dBm.

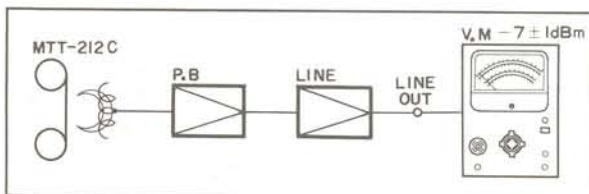

1-3 Confirmation of Playback Frequency Response

• Adjustment of Head Azimuth

- 1) Remove the HEAD LID and the HEAD COVER UNIT by removing two screws located on its under part.
- 2) Connect two units of AC voltage meter respectively to the LINE OUT terminals left and right channels.
- 3) Play back the azimuth adjustment tape MTT-114 (10kHz) and adjust the AZIMUTH ADJUSTMENT screw installed in the left side of the REC/PB HEAD as shown to obtain equal levels of both left and right channels at maximum output.
- 4) Paste the screw lock on it after adjustment.

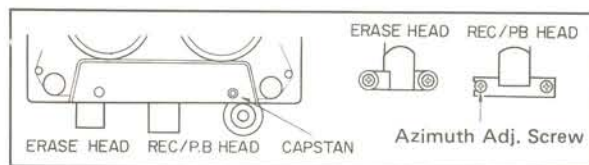
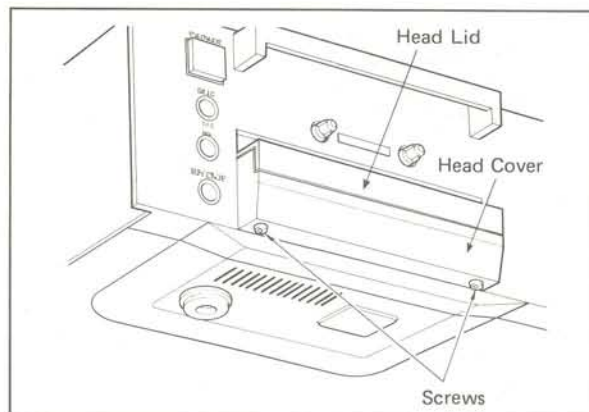

• Confirmation of Playback Frequency Response

- 1) Confirmation left and right channels by the following procedures.
- 2) Connect the AC voltage meter to the LINE OUT terminal.
- 3) Set the FOCUS switch at "SHARP" position and MPX FILTER switch at "OFF" position.
- 4) Play back the playback frequency response test tape MTT-216U (LH) or MTT-116K (CrO₂) and make sure of keeping playback level at 315Hz and within ± 3 dB at 10kHz.

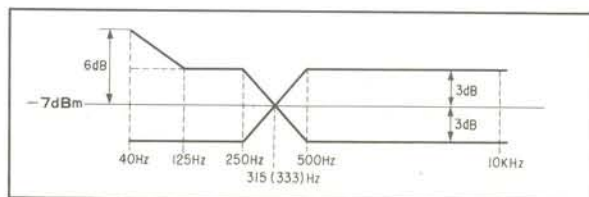

2. ADJUSTMENT OF RECORDING RELATION

2-1 Adjustment of Peak Level Meter

Note: Be sure to do this adjustment more than 5 minutes passed after switched on.

- 1) Adjust left and right channels by the following procedures.
- 2) Connect respectively the low frequency oscillator to LINE IN terminal and AC voltage meter to the LINE OUT terminal.
- 3) Rotate VR107, 108, 109, 110 mechanically at the center position.
- 4) In recording mode, supply the signal to the LINE IN terminal to obtain a signal of +1dBm, 1kHz at the LINE OUT terminal.

- 5) Adjust VR107 of the left channel and VR108 of the right channel so as to indicate -30 ± 5 dB in the PEAK LEVEL METERS when supplying a 30dB decreased signal.
- 6) Adjust VR109 of the left channel and VR110 of the right channel so as to indicate 0 ± 1.5 dB in the meters when supplying a 30dB increased signal.
- 7) Repeat the procedures 5), 6) and 7) several times.

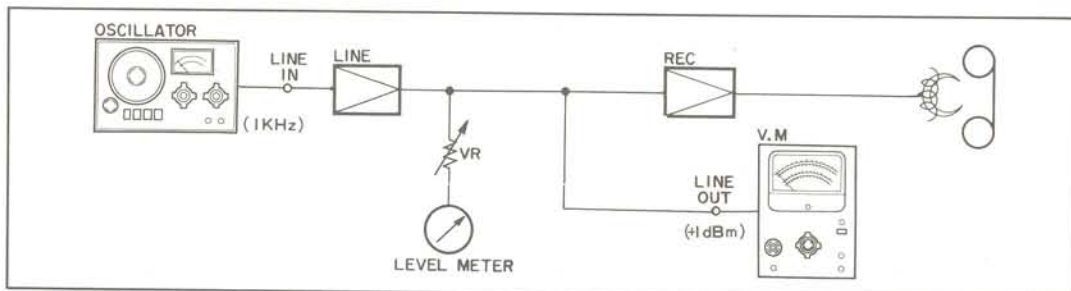

2-2 Adjustment of Recording Level

- 1) Adjust left and right channels by the following procedures.
- 2) Connection is the same as in procedures 2-1-2).
- 3) In recording mode, supply the signal to the LINE IN terminal so as to obtain the signal -7 dBm 333Hz (or 315Hz) at LINE OUT terminal.

- 4) Record this signal on the reference tape AC-511 (CrO₂).
- 5) Play back this tape and adjust VR111 of the left channel and VR112 of the right channel so as to obtain a playback level of -7 ± 1.5 dBm.

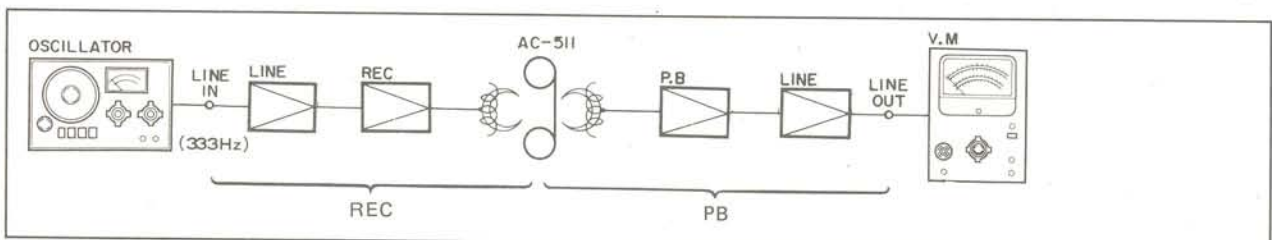

2-3 Adjustment of recording Bias

Note: Set the FOCUS switch at "SHARP" position and DOLBY NR switch at "OFF" position. Connection is the same as in procedures 2-1-2).

1. "CrO₂" Position

- 1) Supply a signal 20dB lower than Reference recording level of 40Hz to 16kHz and set the level so as to obtain a signal of -27 dBm (-20 VU) at the LINE OUT terminal.
- 2) By using the reference tape AC-511 (CrO₂), record and play back this signal and adjust VR113 and 114 so as to satisfy the playback

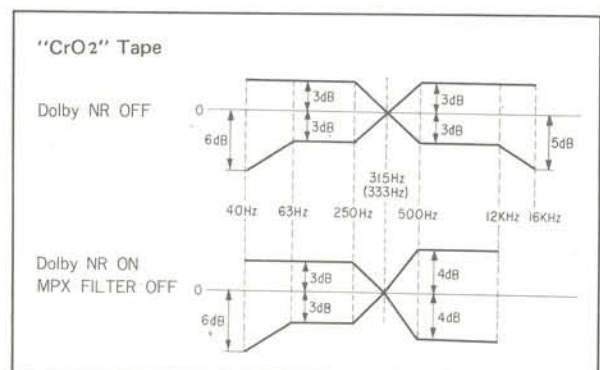

level of each frequency against the playback level of 315Hz (or 333Hz) as in the undershown chart. When setting the DOLBY NR switch to "ON" or "OFF" position, make sure of its variation.

- 3) Set the input level at 1kHz, indicating -8dB , 0VU in the PEAK LEVEL meter, and make sure that the total harmonic distortion of the recording and playback is less than 2.5%.

2. "LH" Position

- 1) After the abovementioned procedures, by using the tape of MAXELL UD-60 record and play back the signal of 40Hz to 14kHz, and adjust VR116 in order to satisfy the undershown chart as same as the procedure 2-3-1-2).
- 2) Repeat the procedure 2-3-1-3) and make sure that the total harmonic distortion of the recording and playback is less than 2.0%.

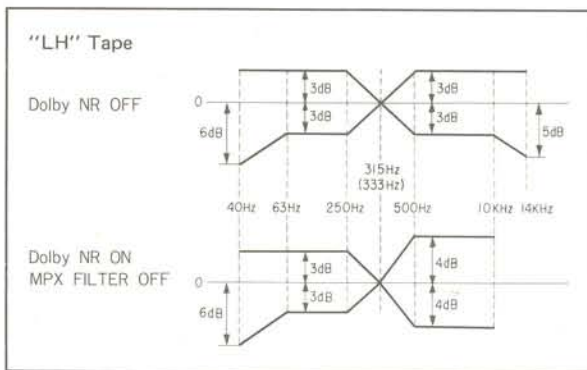

3. "METAL" Position

- 1) Set TAPE SELECTOR at "METAL" position.
- 2) By using the reference tape AC-701* (Metal), record and play back the signal of 40Hz to 18kHz and adjust VR115 in or to satisfy the undershown chart as same as the procedure 2-3-1-2).

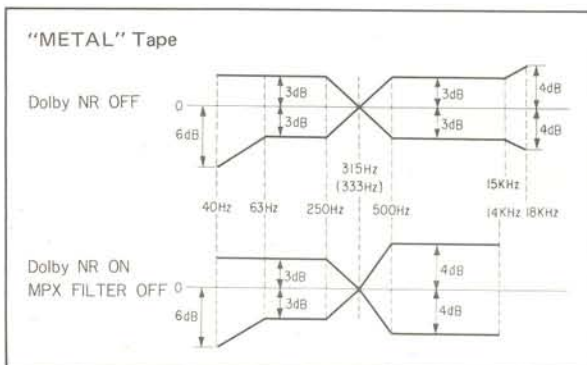

- 3) Repeat the procedure 2-3-1-3), and make sure that the total harmonic distortion is less than 2.0%.

* Instead of AC-701, MA-RC46 manufactured by TDK may be used.

3. CONFIRMATION OF STBY ACTION

- 1) Turn fully counterclockwise "STBY LENGTH ADJ", VR117 located on the rear panel.
- 2) Let STBY function and make sure that the figure of TAPE COUNTER shows 3 ± 1 .

4. CONFIRMATION OF BIAS OSCILLATOR FREQUENCY

Connect the frequency counter to both end of the resistor R103 (10Ω) and make sure that the counter shows $105\text{kHz} \pm 10\text{kHz}$.

Notes:

1. Reference Playback State means that, when the reference tape of 315Hz or 333Hz is played back, the LINE OUT terminal obtains 160nWb/m the signal of -7dBm lower than reference output level.
2. Reference Recording Level is the recording level to obtain the same output level as the reference playback level of 315Hz or 333Hz 160nWb/m .
3. Regular Recording state means that the unit is adjusted to have reference recording level when the signal of 315Hz or 333Hz is supplied to the LINE IN terminal with reference input level, which obtains reference recording level.

IC FUNCTIONAL BLOCK DIAGRAM

• AN6251

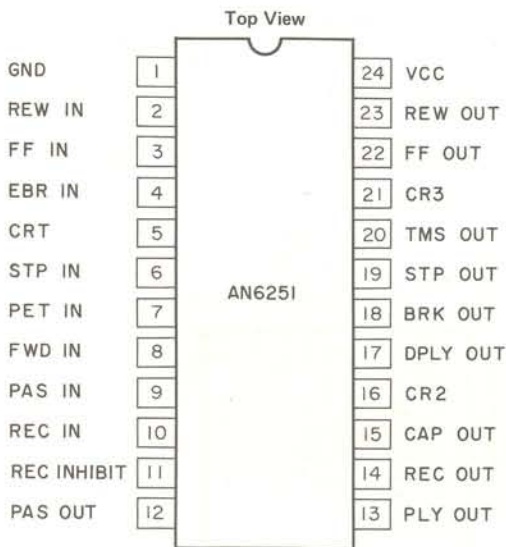
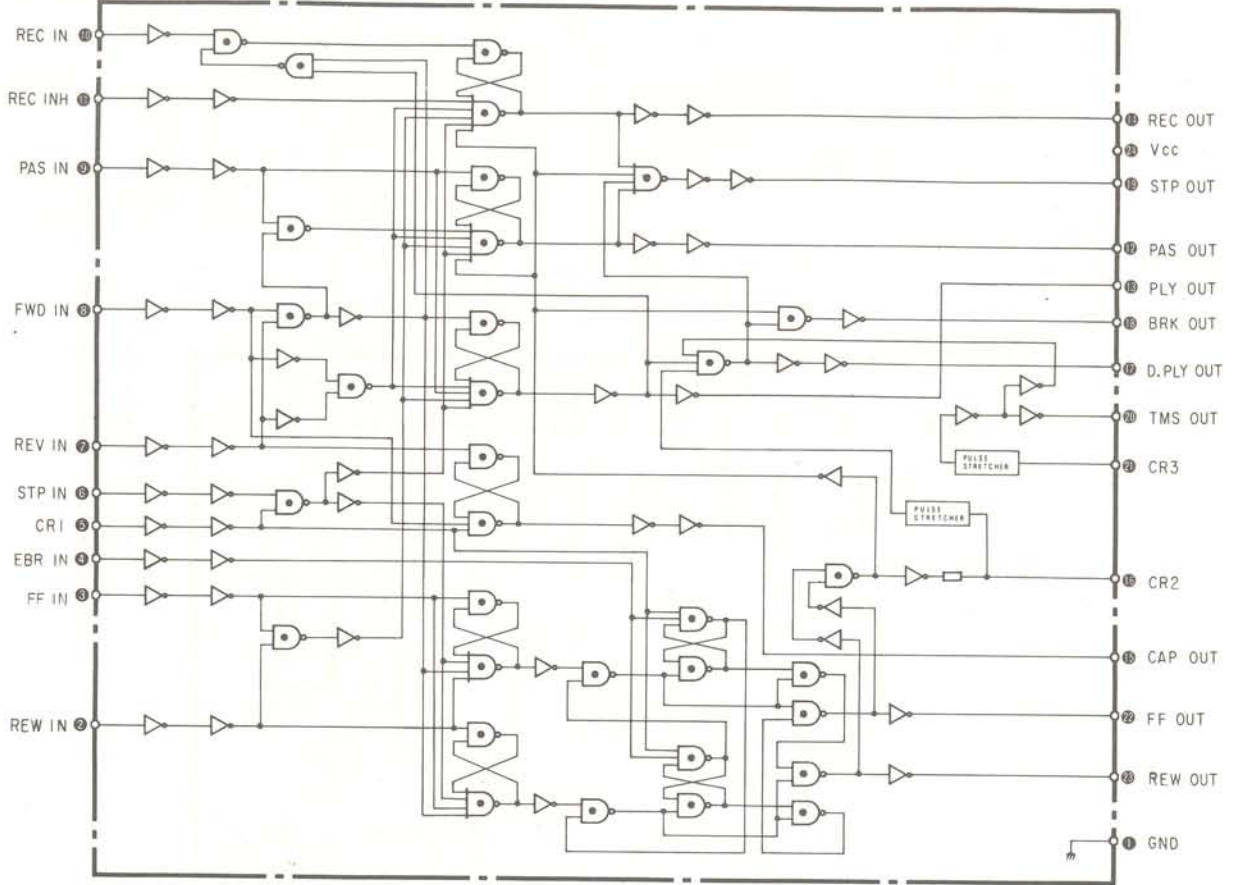

Truth Value Table (Negative Logic)

Terminal	22	23	13	17	15	12	19	14	18	20
Output Mode	FF out	REW out	PLY out	D PLY out	CAP out	PAS out	STP out	REC out	BRK out	TMS out
FWD	0	0	1	1Δ	0	0	0	0	1	0
REV	0	0	1	1Δ	1	0	0	0	1	0
FF	1	0	0	0	*	0	0	0	1	0
REW	0	1	0	0	*	0	0	0	1	0
STP	0	0	0	0	*	0	1	0	0	0
PAS	0	0	0	0	*	1	0	0	0	0
REC	0	0	0	0	*	0	0	1	0	0
REC PAS (F)	0	0	0	0	0	1	0	1	0	0
REC PAS (R)	0	0	0	0	1	1	0	1	0	0
REC FWD	0	0	1	1Δ	0	0	0	1	1	0
REC REV	0	0	1	1Δ	1	0	0	1	1	0

* Previous status maintained

Δ After a delay

• NE646BN

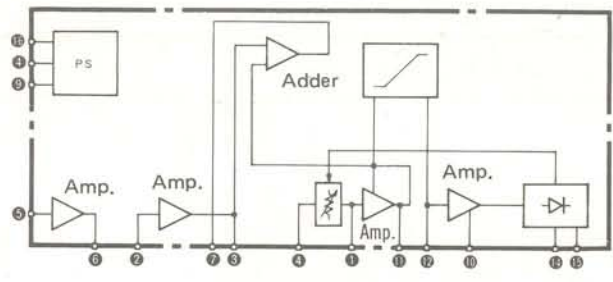

• AN6551

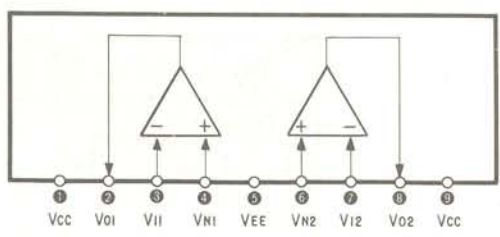

• HD74LS00

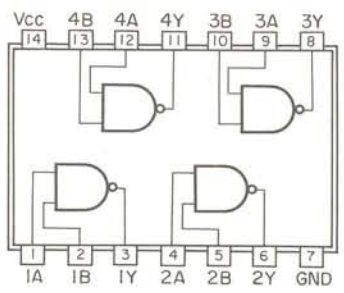

• HD74LS02

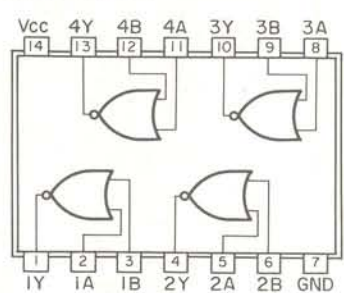

• μPD4066C

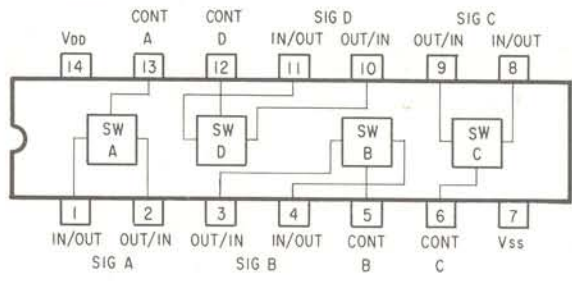

• Logic Symbol and Function Table

• LOGIC SYMBOL

Function	LOGIC SYMBOL	
	MIL	YAMAHA
OR		
AND		
NOT (INVERTER)		
NOR		
NAND		

OR

A	B	Y
L	L	L
H	L	H
L	H	H
H	H	H

AND

A	B	Y
L	L	L
H	L	L
L	H	L
H	H	H

NOT (Inverter)

A	Y
L	H
H	L

NOR

A	B	Y
L	L	H
H	L	L
L	H	L
H	H	L

NAND

A	B	Y
L	L	H
H	L	H
L	H	H
H	H	L

Exclusive OR

A	B	Y
L	L	L
H	L	H
L	H	H
H	H	L

WIRING

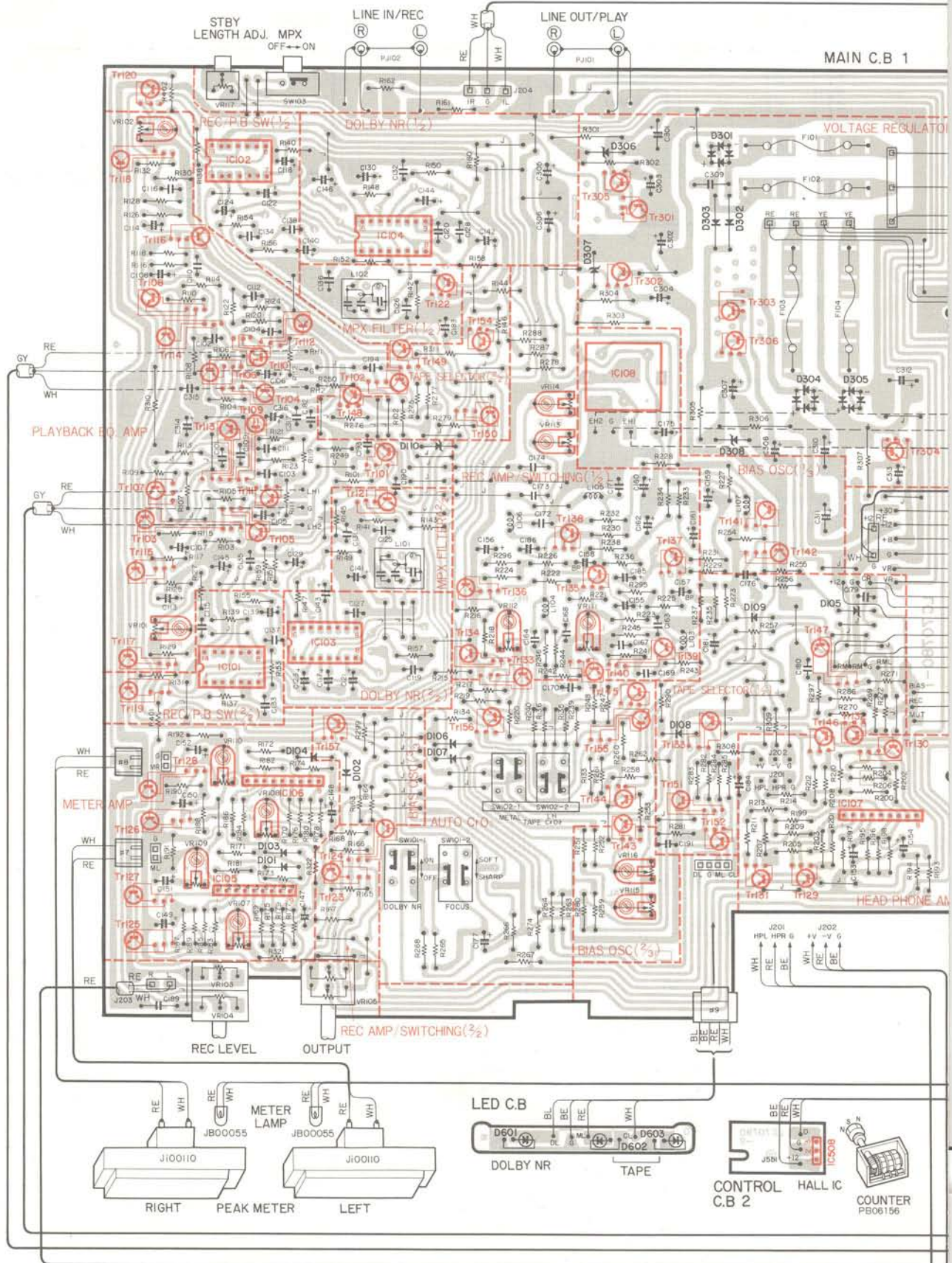

*This wiring is shown in accordance with the U.S.A. and Canadian model.

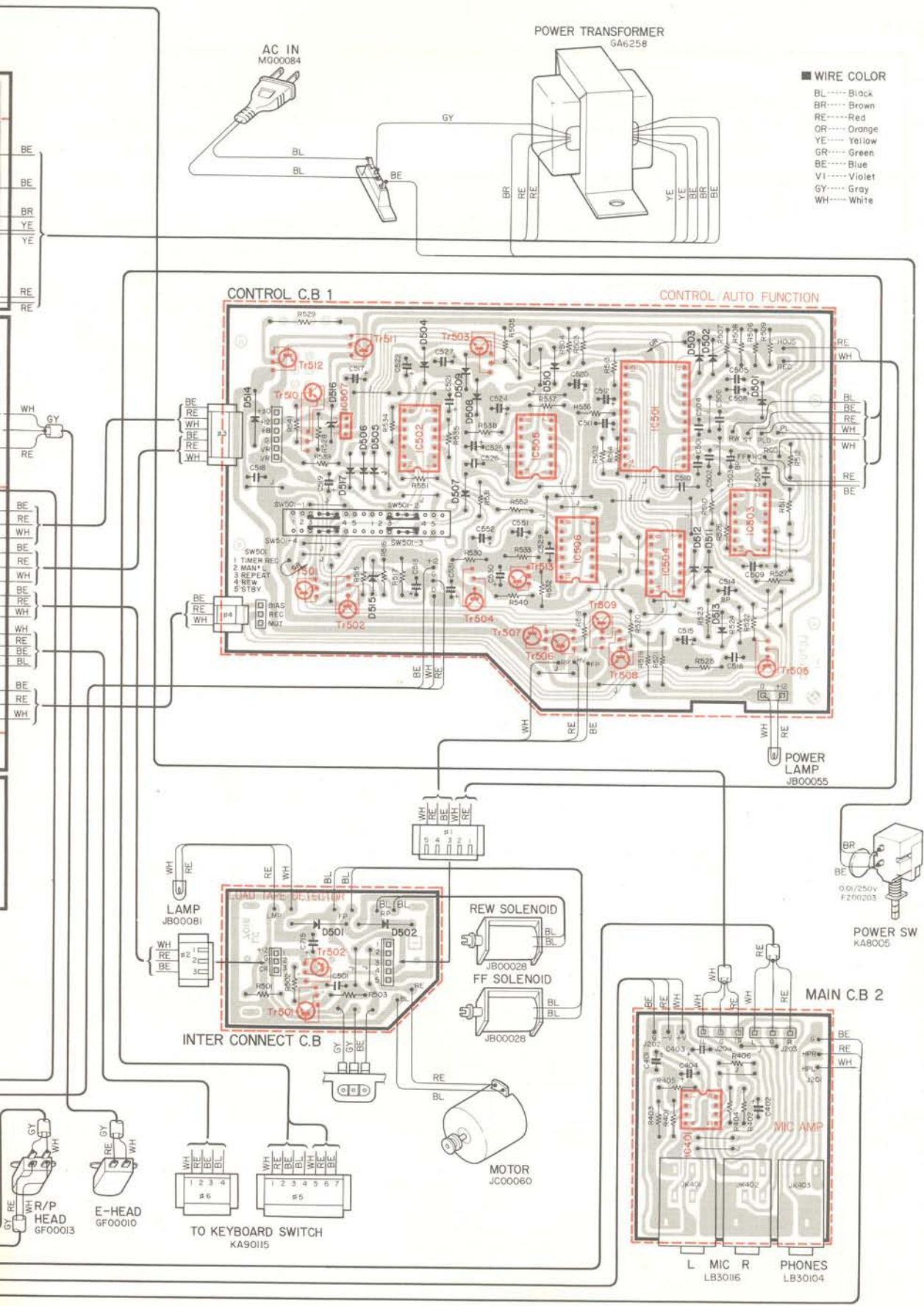

- WIRE COLOR
- BL..... Black
 - BR..... Brown
 - RE..... Red
 - OR..... Orange
 - YE..... Yellow
 - GR..... Green
 - BE..... Blue
 - VI..... Violet
 - GY..... Gray
 - WH..... White

SCHEMATIC DIAGRAM

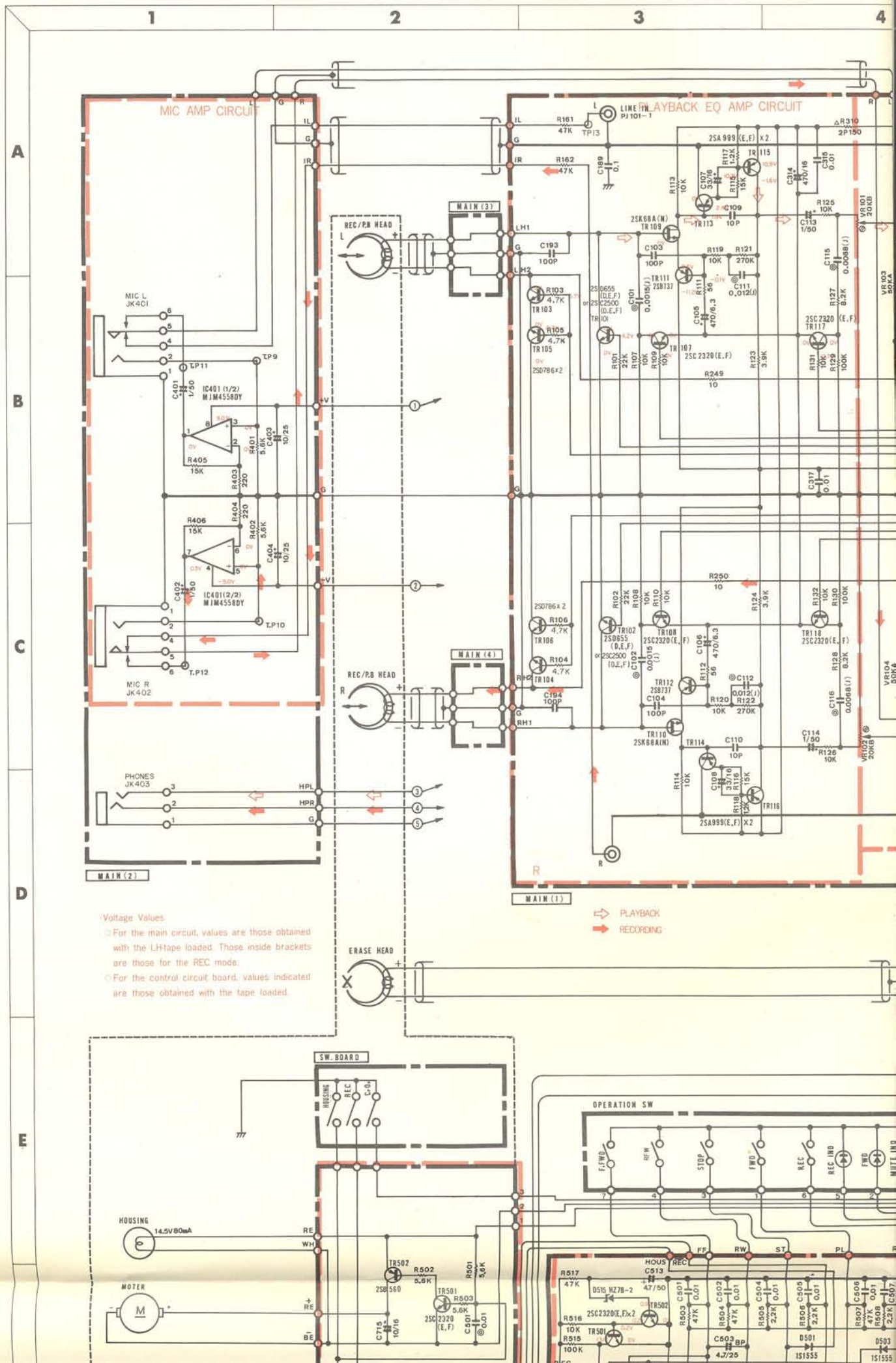

Voltage Values

- For the main circuit, values are those obtained with the LH-tape loaded. Those inside brackets are those for the REC mode.
- For the control circuit board, values indicated are those obtained with the tape loaded.

PLAYBACK
 RECORDING

C

D

F

F

G

H

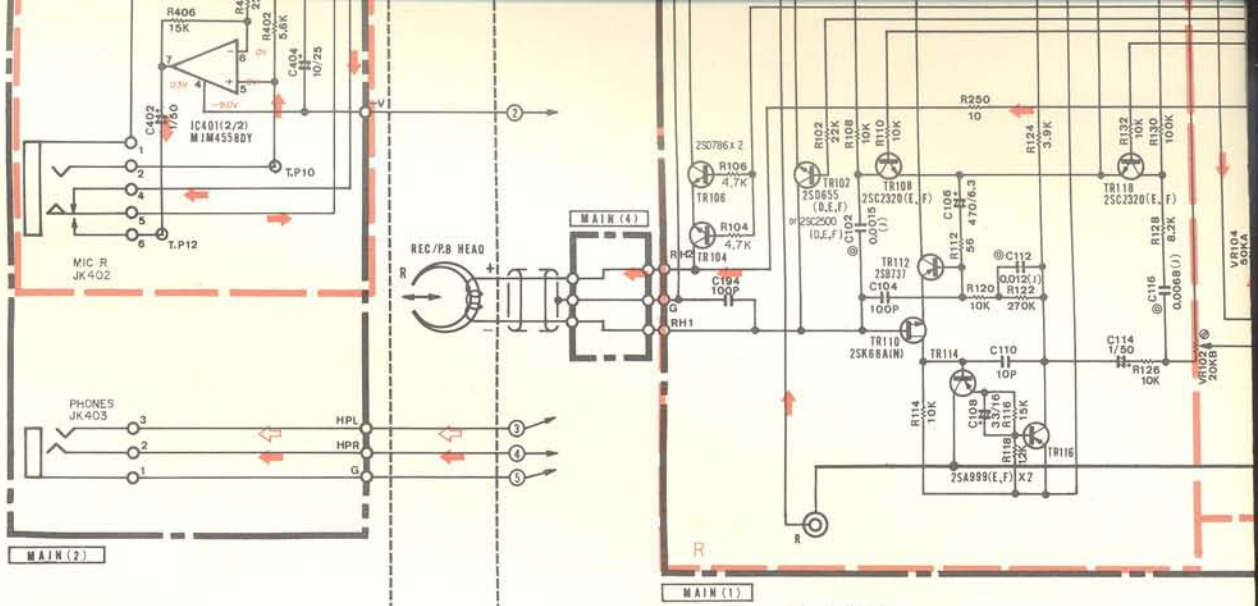

- Voltage Values
- For the main circuit, values are those obtained with the LHTape loaded. Those inside brackets are those for the REC mode.
- For the control circuit board, values indicated are those obtained with the tape loaded.

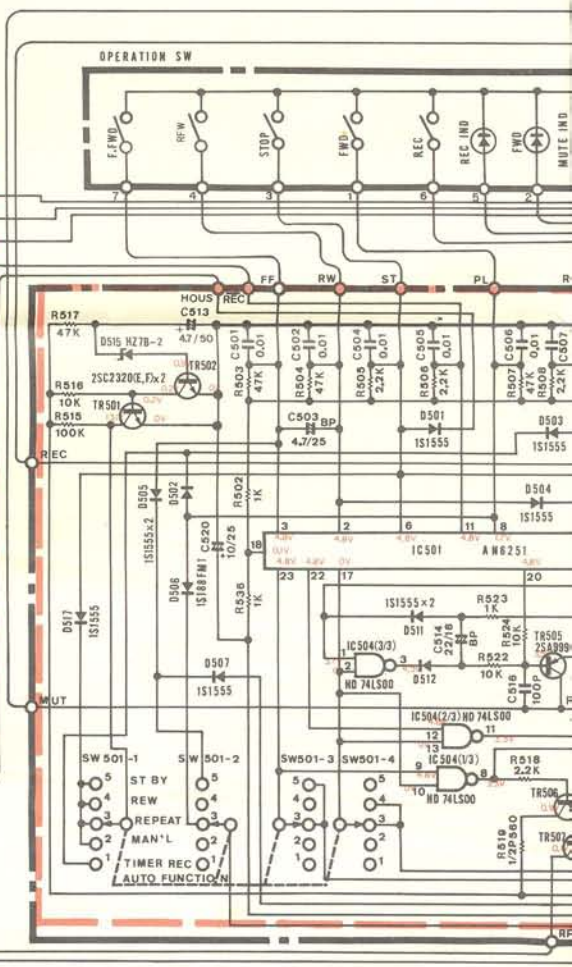
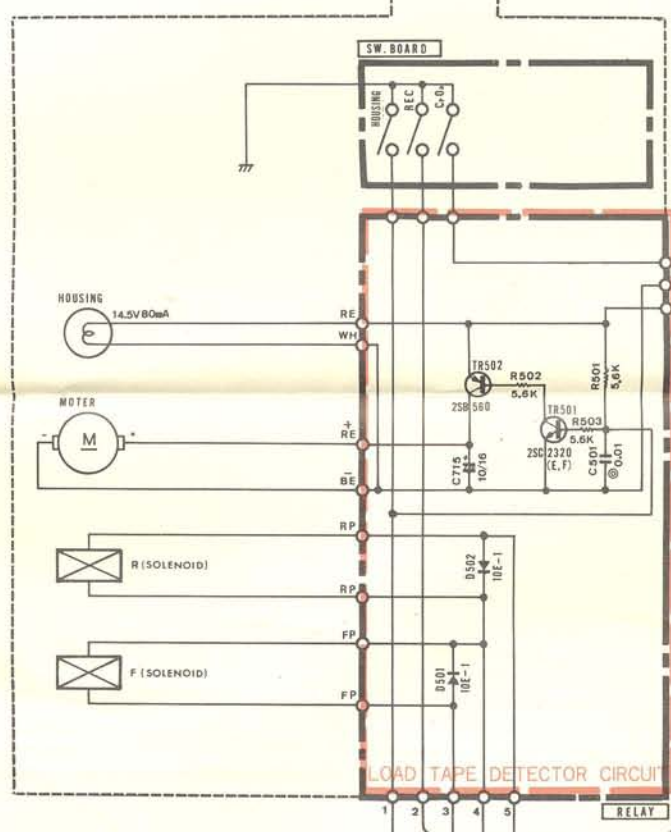

RESISTOR	
REMARKS	PARTS
NO MARK	CARBON RESISTOR
△	METALIZED OXIDATION RESISTOR
⊙	SEMI VARIABLE RESISTOR

CAPACITOR	
REMARKS	PARTS
NO MARK	CERAMIC CAPACITOR
⊙	MYLAR CAPACITOR
⊖	MICA CAPACITOR

ICs

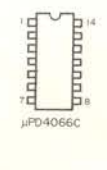
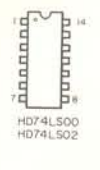
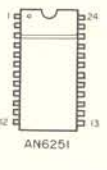
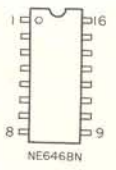

DN6838 μPCT8L05

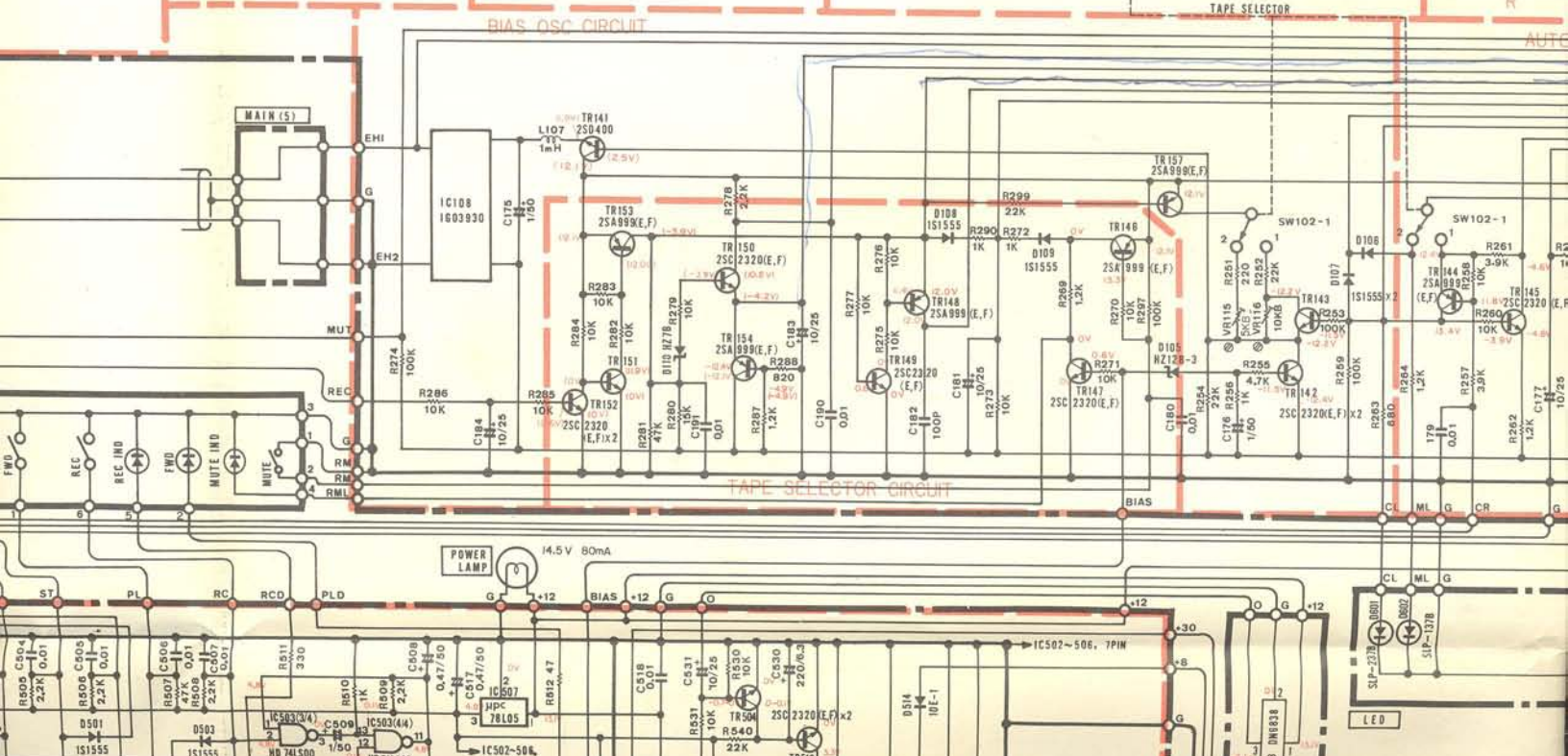
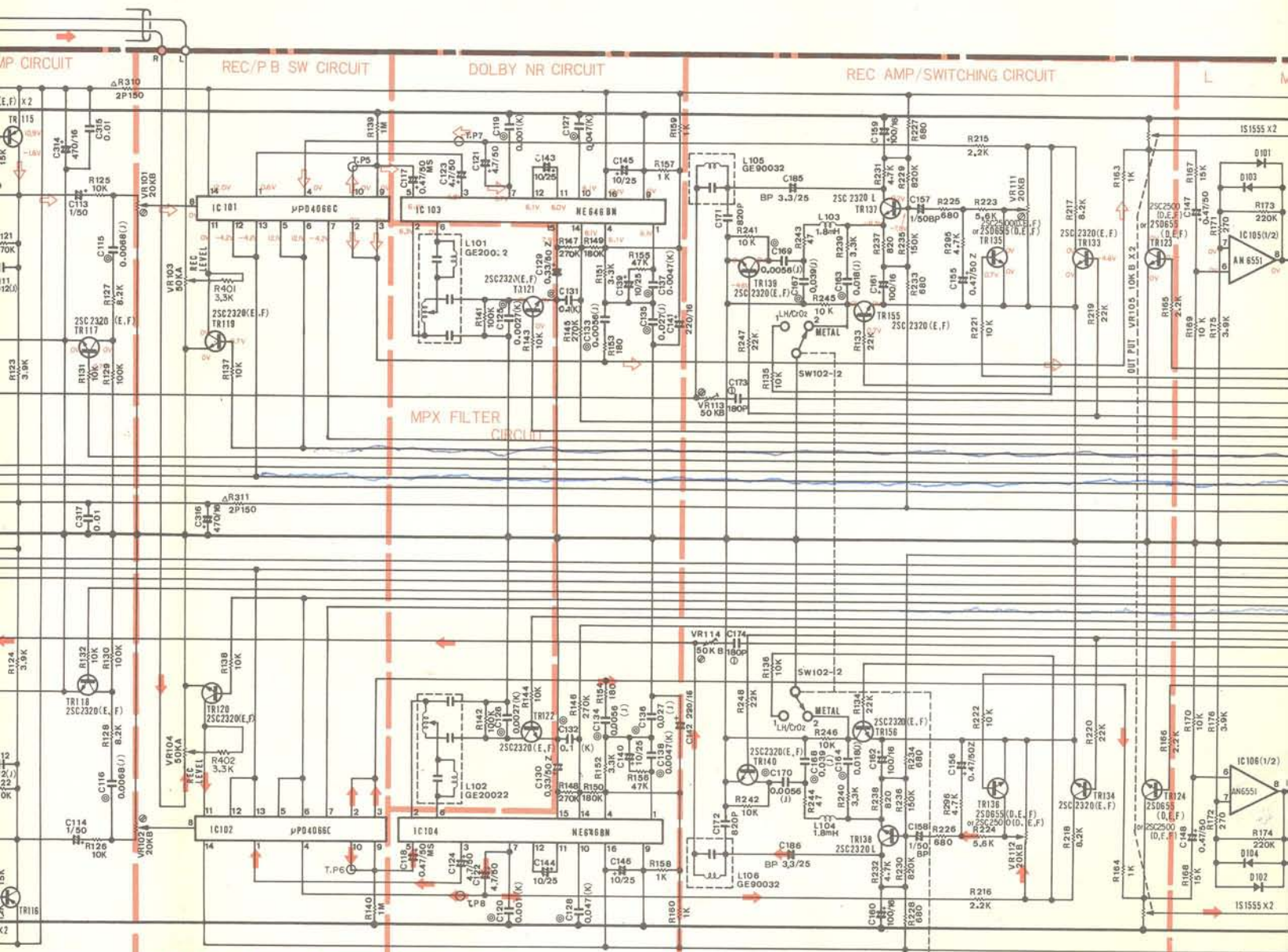

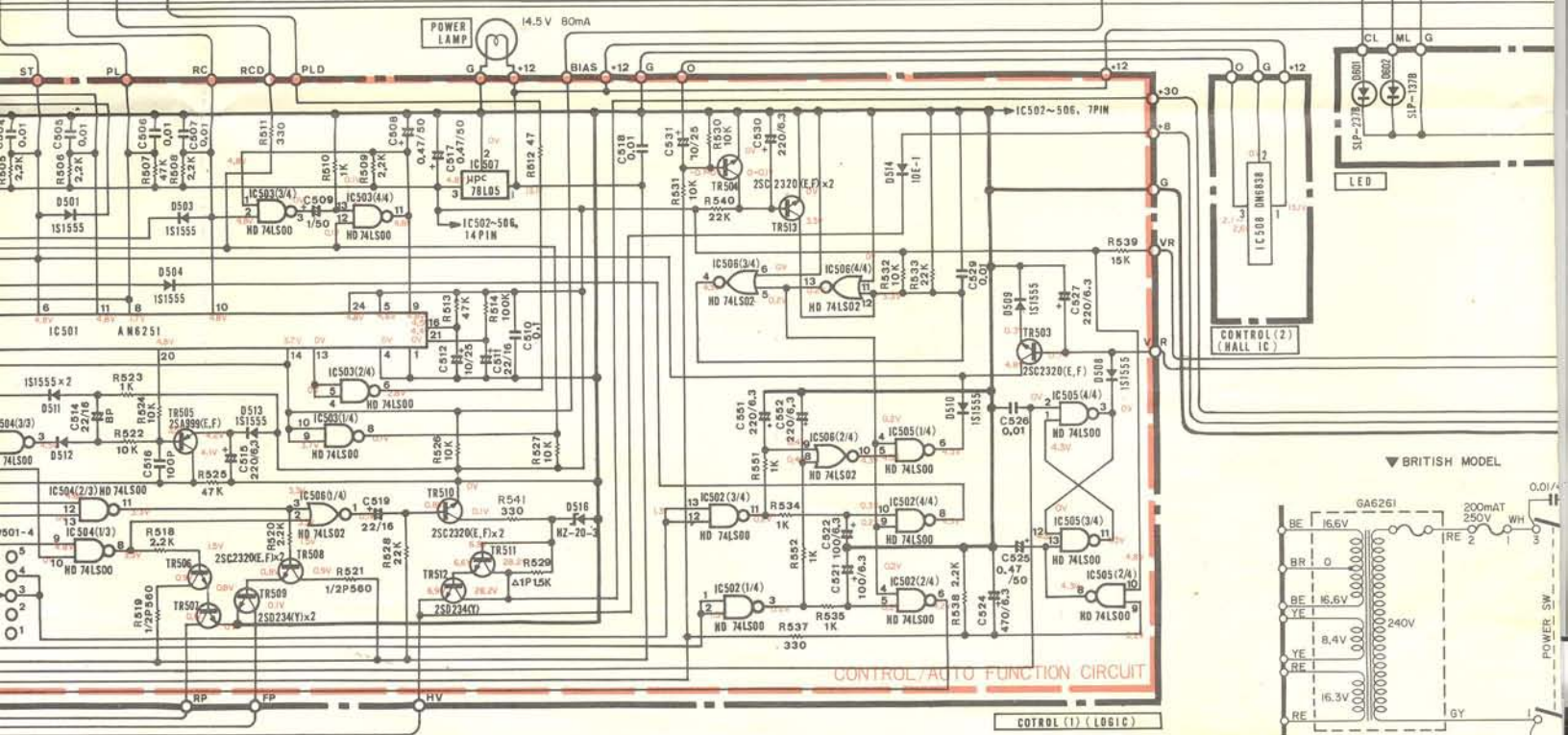
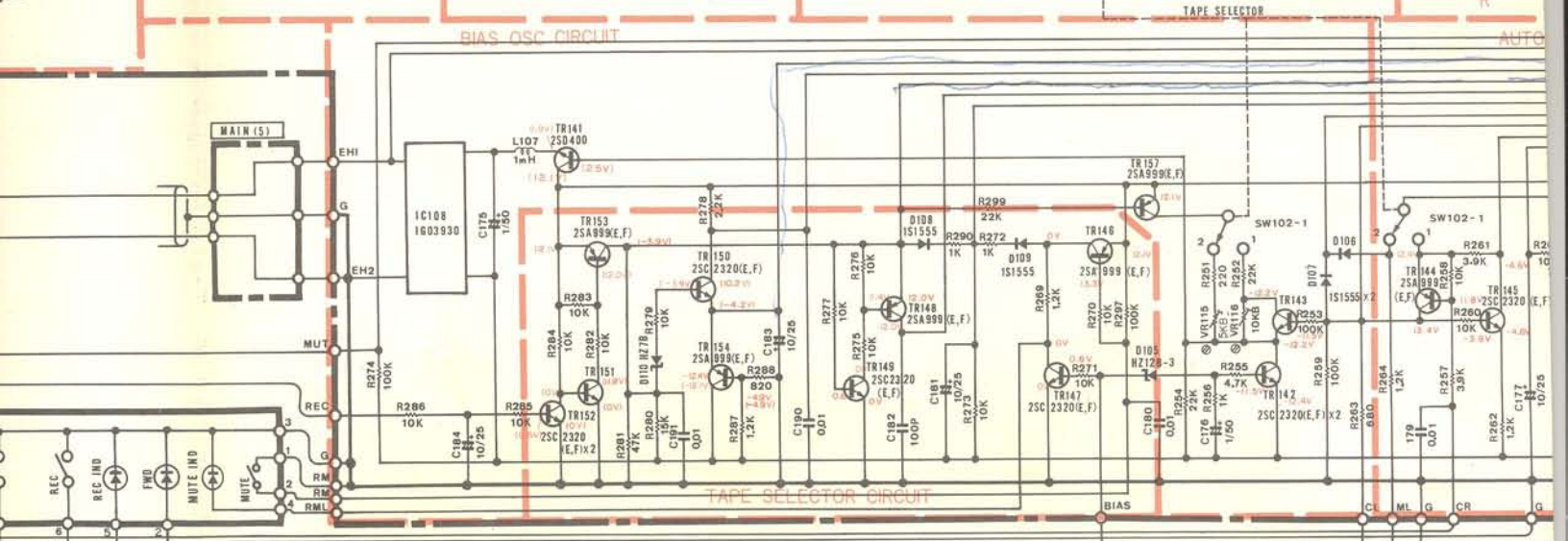
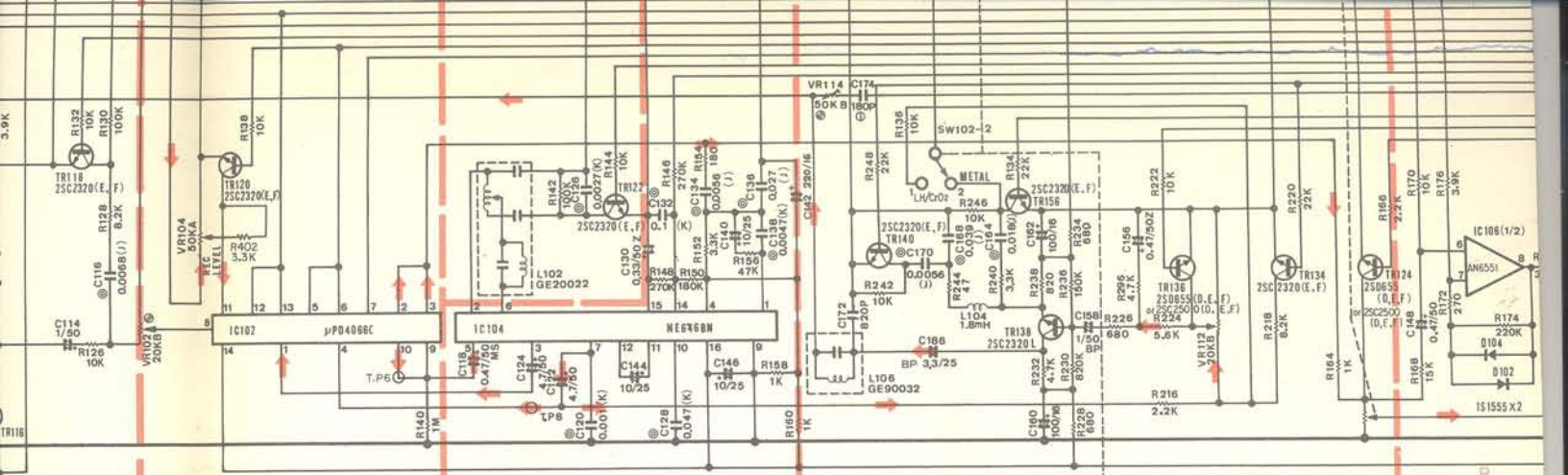

TRANSISTORS

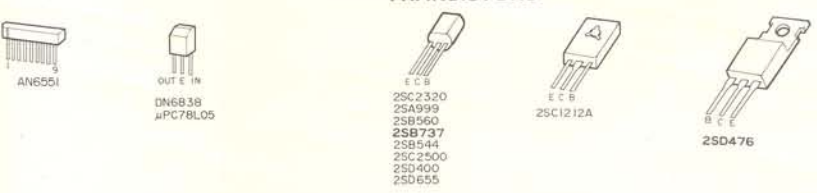

DIODES

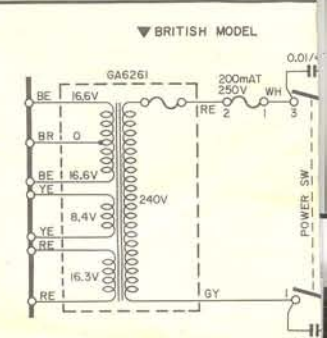
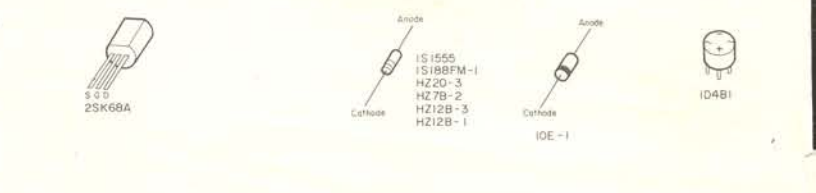

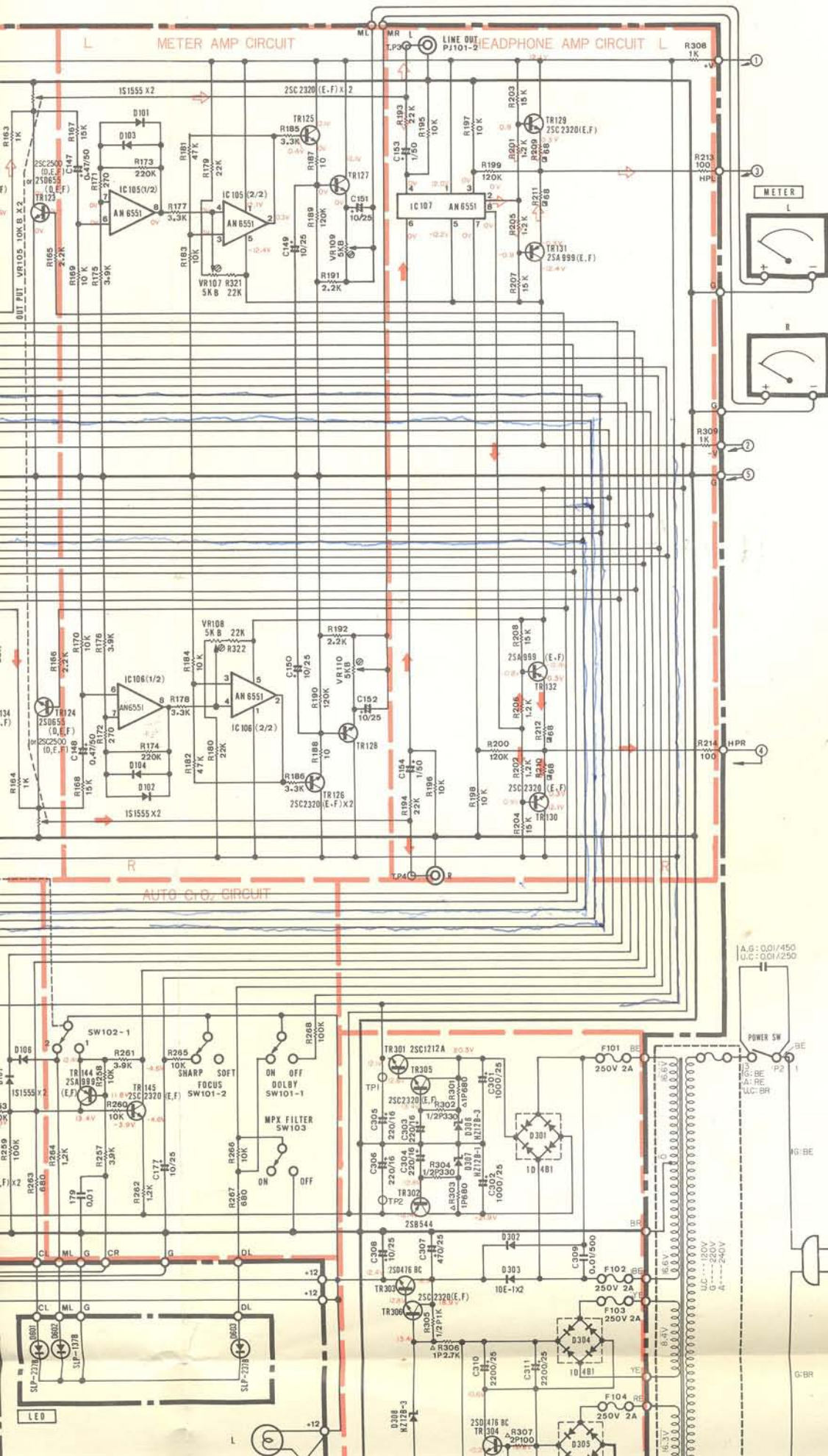

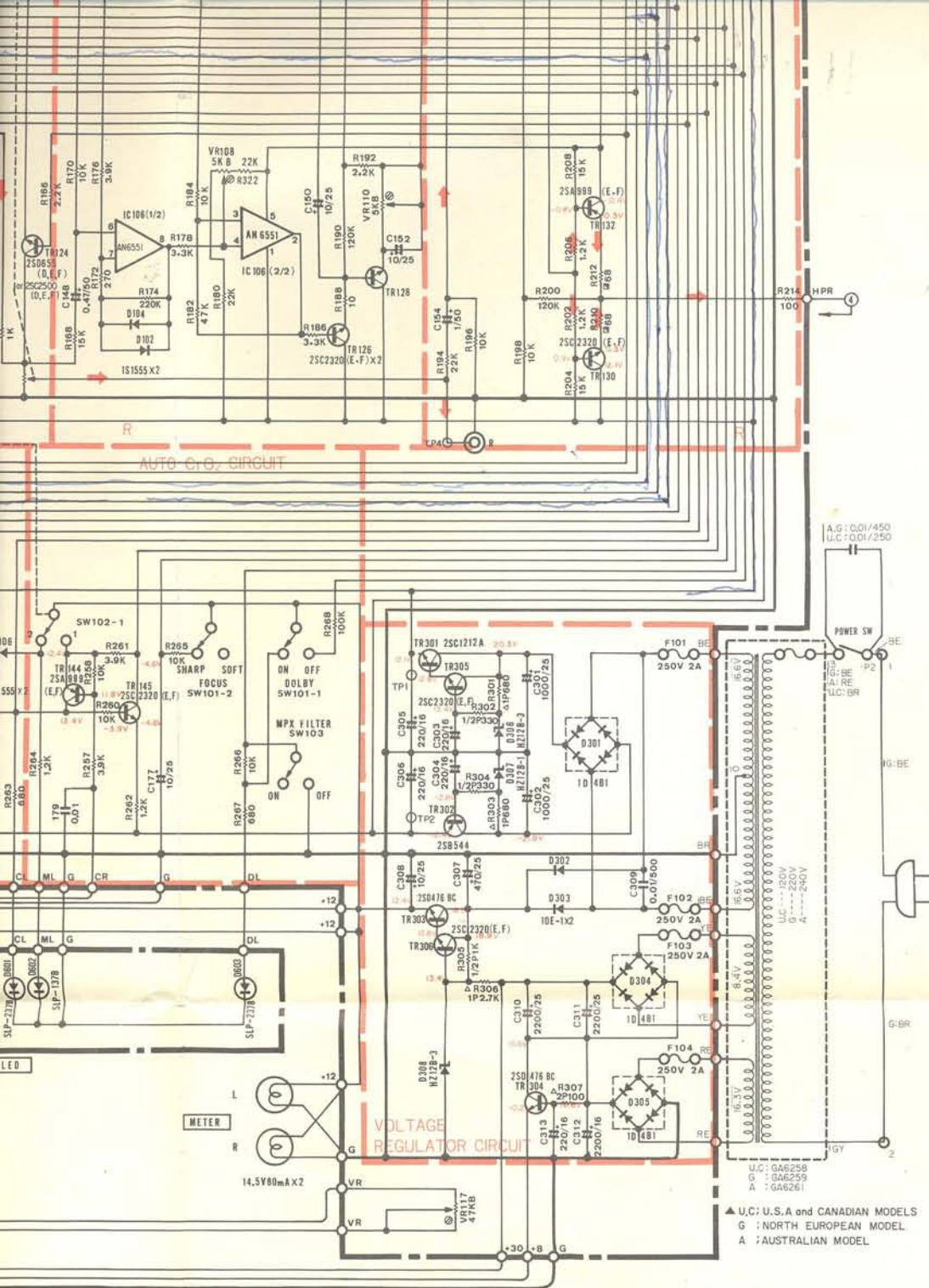

▼ BRITISH MODEL

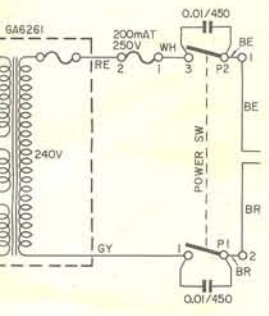

▼ GENERAL MODEL

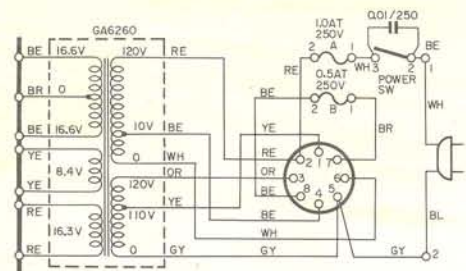

Destination	U. C.	R. A.	G. B.
F101	2.0A 250V	2.0A 250V	1.6A 250V
F102	2.0A 250V	2.0A 250V	1.6A 250V
F103	2.0A 250V	2.0A 250V	1.6A 250V
F104	3.0A 250V	2.0A 250V	1.6A 250V



PARTS LIST

K-850

■CONTENTS	Page
■EXPLODED VIEW(All over).....	1
■PARTS LIST(All over).....	2
■EXPLODED VIEW(TM-3A Mechanism Ass'y).....	5
■PARTS LIST(TM-3A Mechanism Ass'y).....	6
■PARTS LIST(Control C. Board).....	8
■PARTS LIST(Main C. Board).....	10
■PARTS LIST(LED C. Board).....	15
■PARTS LIST(Relay C. Board).....	15

004400

SINCE 1887



YAMAHA

NIPPON GAKKI CO., LTD. HAMAMATSU, JAPAN

'80. 3. 2.4K



Printed in Japan

PARTS LIST (All over)

K-850

-Ref. No.	Part No.	Description	(部 品 名)	Remarks	Common model	Markets
※ 1	32 00 00 NB 09 54 50	Front Panel Unit	パネルユニット			J
※ "	32 00 00 NB 09 54 60	"	"			R,A,G,B
※ "	32 00 00 NB 09 78 50	"	"			U,C
※ 1-1	32 00 00 NA 07 42 60	L,E,D Circuit Board	LEDシート			
※ 1-2	32 00 00 NB 09 29 80	L,E,D Connector Assembly	LEDコネクタAss'y			
※ 1-3	32 00 00 BA 07 62 70	Sensor Cover	センサーカバー(シルバー)			
1-4	32 00 00 BA 07 45 40	Operation Panel (A)	操作パネル(A)(シルバー)		TC-920	
1-5	32 00 00 BA 07 45 50	Operation Panel (B)	操作パネル(B)(シルバー)		TC-920	
※ 1-6	32 00 00 CB 09 74 50	Guide (L) for Cassette half	カセットガイド(L)(シルバー)			
※ 1-7	32 00 00 CB 09 74 60	Guide (R) for Cassette half	カセットガイド(R)(シルバー)			
※ 1-8	32 00 00 CB 09 23 30	Side Cover (L)	サイドカバー(L)(シルバー)			
※ 1-9	32 00 00 CB 09 23 40	Side Cover (R)	サイドカバー(R)(シルバー)			
※ 1-10	32 00 00 CB 09 27 50	Tape sight lens	テープレンズ			
※ 1-11	32 00 00 CB 09 26 90	Bottom Cover (A) for Mechanism	メカボトムカバー(A)			
1-12	42 00 00 CB 09 36 20	Shade Tape	シャ光テープ			
※ 1-13	42 00 00 CB 09 80 40	Adhesive tape, Operation Panel	操作パネル接着紙			
※ 1-14	42 00 00 CB 09 69 00	Blind Sheet	ブラインドシート			
※ 1-15	42 00 00 CB 09 85 50	Wire Guide	線材ガイド			
1-16	42 00 00 CB 07 41 90	Adhesive Tape ℓ = 300	セキスイダブルタックテープ			
1-17	42 00 00 CB 07 42 00	" ℓ = 280	"			
※ 1-18	42 00 00 Ji 00 11 00	Level Meter	ピークレベルメーター(シルバー)			
※ 1-19	42 00 00 KA 90 11 50	Key-board Switch	キーボードスイッチ(シルバー)			
1-20	32 00 00 NB 09 14 30	Push Button Assembly	プッシュボタンAss'y(シルバー)		TC-320a	
※ 1-21	32 00 00 NB 09 16 80	"	" (シルバー)			
※ 1-22	32 00 00 NB 09 17 60	"	" (シルバー)			
1-23	42 00 00 EK 03 00 70	B.W Head Tapping Screw type II 2.6×8(ZMC2-Y)	鉄B.Wヘッドタッピングネジ (2種ミソナシ)			
※ 1-24	42 00 00 EK 99 50 30	Bind Head Screw B-type 3×6(FCM3-BI)	鉄バインドBタイトネジ			
1-25	42 00 00 CB 09 22 80	Cap For Lamp (Orange)	ランプキャップ(オレンジ)			
※ 2	32 00 00 SM 60 04 00	TM-3A Mechanism Assembly	TM-3A総組立			
※ 3	32 00 00 AA 09 82 80	Plate for Power Switch	パワースイッチ金具			
※ 4	32 00 00 AA 09 91 10	Wire Holder	束線止め			
※ 5	32 00 00 NB 09 16 70	Pully Ass'y, Tape Counter	カウンタープーリー Ass'y			
6	42 00 00 EK 09 00 10	Bind Head Tap-tyte Screw 3×6(ZMC2-Y)	鉄バインドタップタイトネジ			
7	42 00 00 EK 09 50 20	Bind Head B-tyte Screw 3×6(")	鉄バインドBタイトネジ			
※ 8	32 00 00 NA 07 41 80	Control Circuit Board	コントロールシート			
※ 9	32 00 00 NA 07 42 00	Main Circuit Board	メインシート(シルバー)			J,R,A
※ "	32 00 00 NA 07 42 10	"	" (シルバー)			U,C
※ "	32 00 00 NA 07 42 20	"	" (シルバー)			G,B

※ : New Part (新部品)

DESTINATION ABBREVIATIONS J;Japan, R;General, U;U,S,A, C;Canadian, B;British, G;North European A : Australian

Ref. No.	Part No.	Description	(部 品 名)	Remarks	Common model	Markets
※	10	42 00 00 KA 80 14 70	Push Switch J-P3050,120V,3A	ブッシュSW		J,R
	"	42 00 00 KA 80 05 00	" SDG1P,125V,5A	"		U,C
	"	42 00 00 KA 80 05 10	" SDG5P-E,250V,5/80A	"		A,G,B
	11	42 00 00 FZ 00 20 30	Ceramic Capacitor 250VAC,0.01 μ F	セラミックコン		J,R,U,C
	"	42 00 00 FZ 00 15 60	Spark Killer Capacitor ECN-C4A,450VA,0.01 μ F	スパークキラーコン		A,G,B
	12	42 00 00 CB 09 52 60	Cover,Capacitor SB-0833	コンデンサカバー丸形		J,R,U,C
	"	42 00 00 CB 08 86 90	" SB-0866	" 角形		A,G,B
※	13	42 00 00 GA 62 57 40	Power Transformer	電源トランス		J
※	"	42 00 00 GA 62 58 20	"	"		U,C
※	"	42 00 00 GA 62 59 10	"	"		G
※	"	42 00 00 GA 62 61 10	"	"		A,B
※	"	42 00 00 GA 62 60 20	"	"		R
	13-1	42 00 00 LB 20 14 80	Voltage Selector 0211	電圧切換器		R
	14	42 00 00 CB 06 92 50	Binding Tie	インシュロックタイ		
	15	42 00 00 CB 06 86 30	Cord Stopper SR-3P-4	コードストッパー		J,U,C
	15-1	42 00 00 CB 07 27 50	" SR-4N-4	"		R,A,G,B
	16	42 00 00 JB 00 05 50	Pilot Lamp 14.5V, 80mA	パイロットランプリード式		
	17	42 00 00 KB 00 03 10	Fuse 0.5AT,250V	ヒューズ(タイラッシュ)		R
	17-1	42 00 00 KB 00 03 30	" 1.0AT,250V	"		R
	17-2	42 00 00 KB 00 07 00	" 200mA, 250V	ヒューズ(タイムラグ)		B
	18	42 00 00 LA 00 29 50	Terminal 2P	2P中継端子台		
	19	42 00 00 LB 20 12 10	Fuse Holder 1PFH	ヒューズホルダー		R
	"	42 00 00 LB 20 14 70	" 1PFH-M	"		B
	20	42 00 00 MG 00 04 10	Power Cord 2.2m,7A,125V	電源コード		J
	"	42 00 00 MG 00 07 80	" 2m,6A,250V	"		R
	"	42 00 00 MG 00 08 40	" SPT-1,POT-64,10A,125V	"		U,C
	"	42 00 00 MG 00 09 20	" 2.5m,7.5A,250V	"		A
	"	42 00 00 MG 00 09 50	" 2m,2.5A,250V	"		G
	"	42 00 00 MG 00 10 00	" 2m,6A,300/500V	"		B
※	21	42 00 00 PB 06 15 60	Tape Counter	カウンター(シルバー)		
※	22	42 00 00 KA 90 14 50	Remote Rotary Switch (Operate)	リモートロータリーSW (操作ワイヤー部)		
※	23	32 01 80 00 62 47 10	Cabinet	キャビネット		U,C
※	23-1	32 00 00 AA 09 81 50	Top Cover	トップカバー		R,A,G,B
※	24	32 00 00 AA 60 17 50	Bottom Cover	ボトムカバー		
※	25	32 00 00 AA 09 81 70	Rear Panel	リヤパネル(J)		J
※	"	32 00 00 AA 09 81 80	"	" (R)		R
※	"	32 00 00 AA 09 81 90	"	" (U C)		U,C
※	"	32 00 00 AA 09 82 00	"	" (A)		A
※	"	32 00 00 AA 09 82 20	"	" (G)		G
※	"	32 00 00 AA 09 82 30	"	" (B)		B
※	26	32 00 00 AA 60 17 30	Holder, Power Transformer	トランスホルダー		
※	27	32 00 00 AA 60 06 40	Washer	トランスワッシャー		
※	28	32 00 00 BA 07 62 10	Knob, Output	OUT PUTツマミ (シルバー)		
※	29	32 00 00 BA 07 62 30	Knob, REC Level (L)	RECツマミ(L) (シルバー)		
※	30	32 00 00 BA 07 62 50	Knob, REC Level (R)	RECツマミ(R) (シルバー)		
※	31	32 00 00 BA 07 63 10	Head Cover	ヘッドカバー (シルバー)		
※	32	32 00 00 BA 07 84 00	Knob, Switch	SWツマミ小 (シルバー)		

※ : New Part (新部品)

Ref. No	Part No.	Description	(部 品 名)	Remarks	Common model	Markets
※ 33	32 00 00 NB 09 56 60	Head Lid Assembly	ヘッドリッドAss'y(シルバー)			
※ 34	32 00 00 NB 09 56 80	Lamp Lens Assembly	ランプレンズAss'y			
※ 35	32 00 00 CB 09 21 40	Belt	中継ベルト			
※ 36	32 00 00 CB 09 27 00	Bottom Cover (B) for Mechanism	メカボトムカバー(B)			
※ 37	32 00 00 CB 09 27 30	Push lod (A)	プッシュロッド(A)			
38	32 00 00 CB 09 27 40	Push lod (B)	" (B)			
39	32 00 00 CB 09 21 50	Counter Belt	カウンターベルト			
40	32 00 00 CB 08 89 30	Plastic Rivet $\phi 4$	プラスチックリベット			
41	42 00 00 CB 06 88 80	" $\phi 3$	"			
42	42 00 00 CB 07 28 70	Leg	脚			
※ 43	42 00 00 CB 09 33 20	Felt, Leg	トランレグフェルト			
44	42 00 00 CB 08 55 20	Anti Vibration Tape t2×7×80mm	防振テープ			
※ 45	42 00 00 CB 09 68 80	" t3×10×200mm	"			
※ 46	42 00 00 CB 09 68 90	" t3×10×180mm	"			
47	42 00 00 CB 07 66 80	Meter Holder t2×20×50mm	メーター押え			
※ 48	42 00 00 CB 09 79 10	Washer	スライドワッシャー			
49	42 00 00 EK 09 50 40	Bind Head B-type Screw 3×10(ZMC2-Y)	鉄バインドBタイトネジ			
50	42 00 00 EK 09 50 20	" 3×6(")	"			
※ 51	42 00 00 EK 39 50 30	" " (ZMC2-BI)	"			
52	42 00 00 ED 03 00 60	Bind Head Screw 3×6(ZMC2-Y)	鉄バインド小ネジ			
※ 53	42 00 00 EN 23 10 10	Bind Head Tapping Screw type II 2.6×6(FNM3-3g)	鉄バインドタッピングネジ (2種ミソなし)			
55	42 00 00 EK 03 00 60	BW Head Tapping Screw type II 3×8 (ZMC2-Y)	鉄B.Wヘッドタッピングネジ (2種ミソ)			
※ 57	42 00 00 EK 13 00 20	BW Head Screw 4×8(FNM3-3g)	鉄B.Wヘッド小ネジ			
※ 59	42 00 00 EH 93 00 60	Pan Head Screw, Sems Type With Washer 3×6(ZMC2-Y)	鉄セムスナベ小ネジ (バネ座付)			
60	42 00 00 EH 94 00 80	Pan Head Screw, Sems Type With Washer, Spring Washer 4×8(ZMC2-Y)	鉄セムスナベ小ネジ (バネ+平座付)			
61	42 00 00 EV 42 00 30	Toothed lock Washer 3 ϕ (ZMC2-Y)	外歯形歯付座金			
62	42 00 00 EV 90 11 30	Washer 0.8×4.1×9.5mm	ファイバーワッシャー			R, A, G, B
63	42 00 00 BB 00 44 30	Female Contact SHF-001T-08CS	2.5ピッチコンタクトピン	コントロール、メーターコネクタピン		
64	32 00 00 CB 07 95 20	Hole Cap	ホールキャップ			U, C
65	42 00 00 EK 33 00 10	B.W Head Tapping Screw 3×12- $\phi 10$ (FCM3-BI)	鉄B.Wタッピングネジ			"
※ 66	42 00 00 EK 36 51 00	B.W Head Screw 4×16- $\phi 10$ (FCM3-BI)	鉄B.W小ネジ			"
※ 67	42 00 00 EN 03 01 20	Bind Head Tapping Screw 3×22(ZMC2-Y)	鉄バインドタッピングネジ 2種ミソなし			"
68	42 00 00 CB 02 54 90	Leg	脚			"
69	32 01 80 00 09 07 20	Front Bar	面棒			U, C
	42 00 00 LB 20 13 80	Connector Housing, Plug H2P-SHF	2.5ピッチハウジング	メーターコネクタハウジング		
	42 00 00 LB 50 02 40	" H5P-SHF	"	コントロールコネクタハウジング		
	42 00 00 LB 60 24 40	" H7P-SHF	"	メインコネクタハウジング		
	42 00 00 LB 30 07 20	" H3P-SHF	"	"		
	42 00 00 LB 40 05 60	" H4P-SHF	"	"		
	42 00 00 LB 60 28 10	" H6P-SHF	"	"		

※ : New Part (新部品)

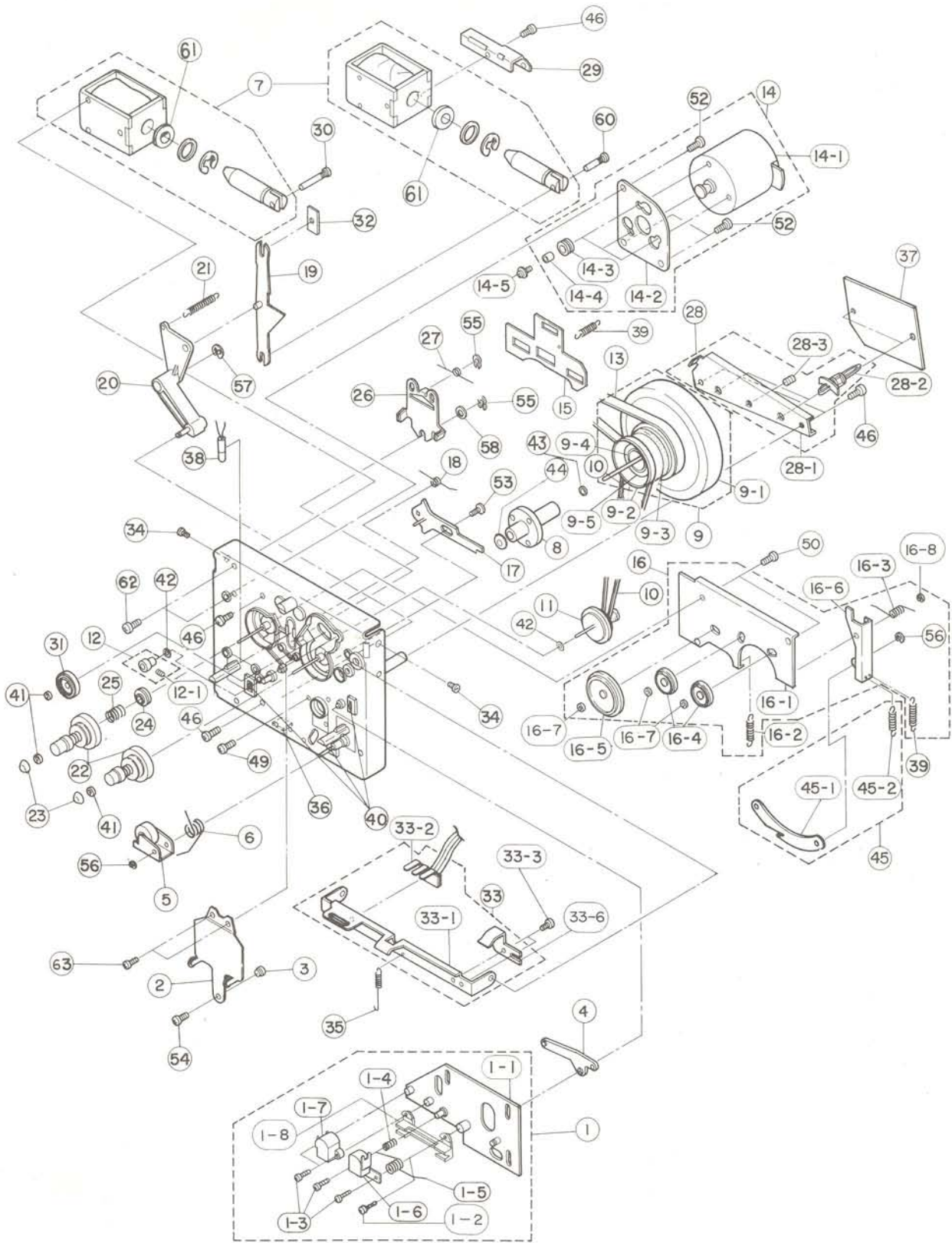

PARTS LIST (TM-3A Mechanism Ass'y)

K-850

Ref. No.	Part No.	Description	(部 品 名)	Remarks	Common model	Markets
	32 00 00 SM 60 04 00	TM-3A Mechanism Assembly	TM-3A総組立			
※ 1	32 00 00 NB 09 55 70	Head Base Unit	ヘッドベースユニット			
※ 1-1	32 00 00 NB 09 65 70	Head Base Assembly	ヘッドベースAss'y			
1-2	42 00 00 ED 02 00 80	Bind Head Screw 2×8(ZMC2-Y)	バインド小ネジ			
1-3	42 00 00 ED 02 00 50	" 2×5(ZMC2-Y)	バインド小ネジ			
※ 1-4	32 00 00 AA 09 67 80	Spring, Azimuth	アジマスSP			
※ 1-5	32 00 00 AA 09 67 90	Spring, Head Base	ヘッドベースSP			
※ 1-6	42 00 00 GF 00 01 30	Rec/Play Back Head	録再ヘッド			
※ 1-7	42 00 00 GF 00 01 00	Erase Head	消去ヘッド			
※ 1-8	32 00 00 CB 09 84 20	Wire Holder	束線止め			
※ 2	32 00 00 NB 09 02 20	Base Holding Assembly	ベース押えAss'y			
※ 3	32 00 00 BB 06 80 70	Collar	カラー			
※ 4	32 00 00 CB 09 06 10	Shift Lever	シフトレバー			
※ 5	32 00 00 NB 09 59 20	Pinch Roller Assembly	ピンチローラAss'y			
※ 6	32 00 00 AA 09 68 40	Spring, Pinch Lever	ピンチレバーSP			
※ 7	42 00 00 JF 00 02 80	Solenoid	ソレノイド			
※ 8	32 00 00 NB 09 02 60	Flywheel Base Assembly	フライホイール軸受Ass'y			
※ 9	32 00 00 NB 09 23 40	Flywheel Unit	フライホイールユニット			
※ 9-1	32 00 00 NB 09 02 70	Flywheel Assembly	フライホイールAss'y			
※ 9-2	32 00 00 CB 09 06 40	Clutch, Pulley	プーリークラッチ			
※ 9-3	42 00 00 CC 01 67 20	Felt, Flywheel	フライホイールフェルト			
※ 9-4	32 00 00 AA 09 68 60	Spring, Clutch	クラッチSP			
※ 9-5	32 00 00 CB 09 08 40	PW 13	PW13			
※ 10	32 00 00 CB 09 06 50	Belt, Idler	アイドラベルト			
※ 11	32 00 00 NB 09 02 80	Pulley Assembly	フリクションプーリーAss'y			
※ 12	32 00 00 NB 09 23 50	Pulley Ass'y for Drive	ドライブプーリーAss'y			
※ 12-1	42 00 00 EZ 00 19 90	Fixing Screw 2×2(ZMC2-Y)	止めネジ(尖先取めネジ)			
※ 13	32 00 00 CB 09 21 30	Belt, Flywheel	メインベルト I			
※ 14	32 00 00 NB 09 55 80	Motor Unit	モーターユニット			
※ 14-1	42 00 00 JC 00 06 00	Motor	モーター			
※ 14-2	32 00 00 AA 60 25 90	Holder Plate, Motor	モーターホルダー			
14-3	32 00 00 CB 08 28 20	Anti-vibration Bush, Motor	モーター取付座			
14-4	32 00 00 BA 07 45 70	Collar	モーター取付座カラー			
14-5	42 00 00 EK 06 50 50	BW Head Screw 2.6×6(ZMC2-Y)	B.Wヘッド小ネジ			
※ 15	32 00 00 BB 06 85 20	Slid Plate	スライドプレート			
※ 16	32 00 00 NB 09 23 60	Idler Base Unit	アイドラベースユニット			
※ 16-1	32 00 00 NB 09 03 00	Idler Base Assembly	アイドラベースAss'y			
※ 16-2	32 00 00 AA 09 69 30	Spring, REW Plate	REWプレートSP			
※ 16-3	32 00 00 AA 09 69 40	Spring, FF Plate	FFプレートSP			
※ 16-4	32 00 00 NB 09 03 30	Idler Assembly (Play)	プレイアイドラAss'y			
※ 16-5	32 00 00 NB 09 03 40	" (REW)	REWアイドラAss'y			
※ 16-6	32 00 00 AA 09 69 50	Disset Lever FF	FF解除レバー			
※ 16-7	32 00 00 CB 09 08 60	Washer 1.6-3.4-0.25	RW1.6-3.4-0.25			
16-8	42 00 00 EV 50 12 00	E Ring ETW-2	E型止め輪			
※ 17	32 00 00 NB 09 03 50	Idler Plate Assembly (Play)	プレイアイドラプレートAss'y			
※ 18	32 00 00 AA 09 69 90	Spring, Idler plate	プレイアイドラSP			
※ 19	32 00 00 NB 09 03 60	Plunger Plate Assembly	プランジャプレートAss'y			
※ 20	32 00 00 NB 09 03 70	Plunger Lever Assembly	プランジャレバーAss'y			
※ 21	32 00 00 AA 09 70 00	Spring, Plunger Lever	プランジャレバーSP			
※ 22	32 00 00 NB 09 03 80	Reel Base Assembly	リール台Ass'y			
※ 23	32 00 00 CB 09 07 70	Reel cap	リールキャップ			
※ 24	32 00 00 NB 09 03 90	Disk Assembly (BT)	BTディスクAss'y			
※ 25	32 00 00 AA 09 70 20	Spring (BT)	BT. SP			

※ : New Part (新部品)

Ref. No.	Part No.			Description	(部 品 名)	Remarks	Common model	Markets
※	26	32:00:00	NB:09:04:00	Brake Plate Assembly	ブレーキプレート Ass'y			
※	27	32:00:00	AA:09:70:40	Spring, Brake	ブレーキSP			
※	28	32:00:00	NB:09:66:30	Flywheel Base Plate Unit	スラスト軸受板ユニット			
※	28-1	32:00:00	AA:60:25:40	Flywheel Base Plate	スラスト軸受板			
※	28-2	32:00:00	CB:08:18:80	P.C.B Holder No.165	PCBホルダー			
※	28-3	32:00:00	CB:08:18:30	Set Screw, Flywheel	フライホイール止めネジ			
※	29	32:00:00	AA:09:88:50	Stay	スティ			
※	30	32:00:00	BB:06:82:30	Plunger Pin L	プランジャピンL			
※	31	32:00:00	NB:09:03:30	Idler Assembly(PLAY)	ブレイアイドラ Ass'y			
※	32	32:00:00	AA:60:23:60	Spacer	スペーサー			
※	33	32:00:00	NB:09:24:10	Cassette Holder Unit	ハーフ押えユニット			
※	33-1	32:00:00	AA:60:27:00	Cassette Holder	ハーフ押え			
※	33-2	32:00:00	NB:09:70:30	Contact Plate Assembly	接点板 Ass'y			
※	33-6	32:00:00	AA:60:05:90	Spring Cassette Holder (Plate-Type)	ハーフ押え板バネ			
※	34	32:00:00	BB:06:82:50	Shaft, Cassette Holder	ハーフ押え軸			
※	35	32:00:00	AA:09:77:80	Spring, Cassette Holder	ハーフ押えSP			
※	36	32:00:00	CE:62:70:10	Damper	レバークッション			
※	37	32:00:00	NA:07:33:50	Relay Circuit Board	中継シート			
※	38	42:00:00	JB:00:08:10	Pilot Lamp	ランプ			
※	39	32:00:00	AA:09:69:60	Spring, FF Disset	FF解除SP			
※	40	42:00:00	EZ:00:19:80	Steel Ball ϕ 2.5	スチールボール			
※	41	32:00:00	CB:09:08:60	Washer	PW1.6-3.4-0.25			
※	42	42:00:00	EV:90:00:40	" 2.1-4-0.25 (STW-ST20)	ポリスライダークワッシャー			
※	43	42:00:00	EV:90:00:50	" 2.6-4.7-0.5 (STW-FT25)	"			
※	44	42:00:00	CB:08:26:10	Washer For Capstan	キャプスタンワッシャ			
※	45	32:00:00	NB:09:23:90	Complete Unit	コンプレートユニット			
※	45-1	32:00:00	NB:09:04:10	Complete Assembly	コンプレート Ass'y			
※	45-2	32:00:00	AA:09:88:40	Spring, Complete Ass'y	コンプレートSP			
※	45-3	42:00:00	EZ:00:19:70	Spring Pin 3×10	スプリングピン			
※	46	42:00:00	EB:03:00:60	Flat Head Screw 3×6(ZMC2-Y)	サラ小ネジ			
※	47	42:00:00	EB:03:00:60	Flat Head Screw 3×6(ZMC2-Y)	サラ小ネジ			
※	48	42:00:00	EB:33:00:80	" 3×8(ZMC2-BI)	"			
※	49	42:00:00	ED:33:00:50	Bind Head Screw 3×5(FCM3-BI)	バインド小ネジ			
※	50	42:00:00	Ei:03:00:60	Bind Head Tapping Screw 3×6(ZMC2-Y)	バインドタッピングネジ			
※	51	42:00:00	EK:03:50:60	B.W Head Tapping Screw 2.6×8(ZMC2-Y)	BWタッピングネジ			
※	52	42:00:00	Ei:03:00:80	Bind Head Tapping Screw 3×8(ZMC2-Y)	バインドタッピングネジ			
※	53	42:00:00	EK:05:70:10	Pan Head Tap tyte Screw(S-tyte) 3×6(ZMC2-Y)	ナベタップタイトネジ (Sタイト)			
※	54	42:00:00	EK:09:60:10	Bind Head Tap-tyte Screw(S-tyte) 3×8(ZMC2-Y)	バインドタップタイトネジ (Sタイト)			
※	55	42:00:00	EZ:00:10:10	Grip Ring GTW-3	グリップ型止め輪			
※	56	42:00:00	EV:50:12:00	E Ring ETWJ-2	E型止め輪			
※	57	42:00:00	EV:50:13:00	" ETWJ-3	"			
※	58	42:00:00	EV:20:03:00	Flat Washer M3	平座金			
※	59	42:00:00	CB:06:92:50	Binding Tie	インシュロックタイ			
※	60	32:00:00	BB:06:84:90	Plunger Pin (S-Type)	プランジャピン S			
※	61	32:00:00	CB:60:01:70	Washer PW10-14-0.13	ポリスライダークワッシャー			
※	62	42:00:00	EB:33:00:80	Flat Head Screw 3×8(FCM3-BI)	サラ小ネジ			
※	63	32:00:00	AA:60:35:30	Base Holding Screw	ベース押エネジ			

※ : New Part (新部品)

K-850 ■ PARTS LIST (Control C. Board)

Ref. No.	Part No.			Description	(部 品 名)	Remarks	Common model	Markets
※	32	00	00	NA:07:41:80	CONTROL CIRCUIT BOARD	コントロールシート		
C501 C502	42	00	00	FG:54:41:00	Ceramic Capacitor 0.01 μ F 50VF(Z)	セラコン		
C503	42	00	00	FM:22:64:70	Electrolytic Capacitor 4.7 μ F 25V	バイポーラケミコン		
C504 C507	42	00	00	FG:54:41:00	Ceramic Capacitor 0.01 μ F 50VF(Z)	セラコン		
※	C508	42	00	00	UW:86:54:70	Electrolytic Capacitor 0.47 μ F 50V	ケミコン小形自立形	
※	C509	42	00	00	UW:86:61:00	" 1 μ F 50V	"	
	C510	42	00	00	FG:54:51:00	Ceramic Capacitor 0.1 μ F 50VFZ(Z)	セラコン	
※	C511	42	00	00	UW:83:72:20	Electrolytic Capacitor 22 μ F 16V	ケミコン小形自立形	
※	C512	42	00	00	UW:84:71:00	" 10 μ F 25V	"	
※	C513	42	00	00	UW:86:64:70	" 4.7 μ F 50V	"	
	C514	42	00	00	FM:09:72:20	" 22 μ F 16V	"	
※	C515	42	00	00	UW:81:82:20	" 220 μ F 6.3V	"	
	C516	42	00	00	FG:51:21:00	Ceramic Capacitor 100PF 50V SL(K)	セラコン	
※	C517	42	00	00	UW:86:54:70	Electrolytic Capacitor 0.47 μ F 50V	ケミコン小形自立形	
	C518	42	00	00	FG:54:41:00	Ceramic Capacitor 0.01 μ F 50VF(K)	セラコン	
※	C519	42	00	00	UW:83:72:20	Electrolytic Capacitor 22 μ F 16V	ケミコン小形自立形	
※	C520	42	00	00	UW:84:71:00	" 10 μ F 25V	"	
	C521 C522	42	00	00	UW:81:81:00	" 100 μ F 6.3V	"	
※	C524	42	00	00	UW:81:84:70	" 470 μ F 6.3V	"	
※	C525	42	00	00	UW:86:54:70	" 0.47 μ F 50V	"	
	C526	42	00	00	FG:54:41:00	Ceramic Capacitor 0.01 μ F 50VF(Z)	セラコン	
※	C527	42	00	00	UW:81:82:20	Electrolytic Capacitor 220 μ F 6.3V	ケミコン小形自立形	
	C529	42	00	00	FG:54:41:00	Ceramic Capacitor 0.01 μ F 50VF(Z)	セラコン	
※	C530	42	00	00	UW:81:82:20	Electrolytic Capacitor 220 μ F 6.3V	ケミコン小形自立形	
※	C531	42	00	00	UW:84:71:00	" 10 μ F 25V	"	
※	C551 C552	42	00	00	UW:81:82:20	" 220 μ F 6.3V	"	
	R502	42	00	00	HJ:35:61:00	Carbon Resistor RD25 SM-8 1K Ω	カーボン抵抗	
	R503 R504	42	00	00	HJ:35:74:70	" 47K Ω	"	
	R505 R506	42	00	00	HJ:35:62:20	" 2.2K Ω	"	
	R507	42	00	00	HJ:35:74:70	" 47K Ω	"	
	R508 R509	42	00	00	HJ:35:62:20	" 2.2K Ω	"	
	R510	42	00	00	HJ:35:61:00	" 1K Ω	"	
	R511	42	00	00	HJ:35:53:30	" 330 Ω	"	
	R512	42	00	00	HJ:35:44:70	" 47 Ω	"	
	R513	42	00	00	HJ:35:74:70	" 47K Ω	"	
	R514 R515	42	00	00	HJ:35:81:00	" 100K Ω	"	
	R516	42	00	00	HJ:35:71:00	" 10K Ω	"	
	R517	42	00	00	HJ:35:74:70	" 47K Ω	"	
	R518	42	00	00	HJ:35:62:20	" 2.2K Ω	"	
	R519	42	00	00	HG:30:55:60	Carbon Resistor RD50 1/2P 560 Ω	"	
	R520	42	00	00	HJ:35:62:20	Carbon Resistor RD25 SM-8 2.2K Ω	"	
	R521	42	00	00	HG:30:55:60	Carbon Resistor RD50 1/2P 560 Ω	"	
	R522	42	00	00	HJ:35:71:00	Carbon Resistor RD25 SM-8 10K Ω	"	
	R523	42	00	00	HJ:35:61:00	" 1K Ω	"	
	R524	42	00	00	HJ:35:71:00	" 10K Ω	"	
	R525	42	00	00	HJ:35:74:70	" 47K Ω	"	
	R526 R527	42	00	00	HJ:35:71:00	" 10K Ω	"	
	R528	42	00	00	HJ:35:72:20	" 22K Ω	"	
	R529	42	00	00	HL:31:61:50	Metal Oxide Film Resistor 1P 1.5K Ω	酸金抵抗	
	R530 R532	42	00	00	HJ:35:71:00	Carbon Resistor RD25 SM-8 10K Ω	カーボン抵抗	
	R533	42	00	00	HJ:35:72:20	" 22K Ω	"	
	R534 R536	42	00	00	HJ:35:61:00	" 1K Ω	"	
	R537	42	00	00	HJ:35:53:30	" 330 Ω	"	

※ : New Part (新部品)

Ref. No.	Part No.				Description	(部 品 名)	Remarks	Common model	Markets
R538	42	00	00	HJ 35 62 20	Carbon Resistor RD25 SM-8 2.2K Ω	カーボン抵抗			
R539	42	00	00	HJ 35 71 50	" 15K Ω	"			
R540	42	00	00	HJ 35 72 20	" 22K Ω	"			
R541	42	00	00	HJ 35 53 30	" 330 Ω	"			
R551 R552	42	00	00	HJ 35 61 00	" 1K Ω	"			
Tr501 Tr504	42	00	00	i C 23 20 10	Transistor 2SC2320(E,F)	トランジスタ			
Tr505	42	00	00	i A 09 99 10	" 2SA999(E,F)	"			
Tr506	42	00	00	i C 23 20 10	" 2SC2320(E,F)	"			
Tr507	42	00	00	i D 02 34 20	" 2SD234(Y)	"			
Tr508	42	00	00	i C 23 20 10	" 2SC2320(E,F)	"			
Tr509	42	00	00	i D 02 34 20	" 2SD234(Y)	"			
Tr510 Tr511	42	00	00	i C 23 20 10	" 2SC2320(E,F)	"			
Tr512	42	00	00	i D 02 34 20	" 2SD234(Y)	"			
Tr513	42	00	00	i C 23 20 10	" 2SC2320(E,F)	"			
D501 D505	42	00	00	i F 00 00 40	Diode IS1555	ダイオード			
D506	42	00	00	i F 00 03 30	" IS188FMI	"			
D507 D513	42	00	00	i F 00 00 40	" 1S1555	"			
D514	42	00	00	i H 00 05 90	" 10E-1	"			
D515	42	00	00	i F 00 06 40	Zener Diode HZ7B-2	ツェナーダイオード			
D516	42	00	00	i F 00 19 50	" HZ-20-3	"			
D517	42	00	00	i F 00 00 40	Diode 1S1555	ダイオード			
IC501	42	00	00	i G 03 03 00	IC AN6251	IC			
IC502 IC505	42	00	00	i G 02 69 10	" HD74LS00	"			
IC506	42	00	00	i G 02 90 00	" HD74LS02P	"			
IC507	42	00	00	i G 03 16 00	" μ PC78L05	"			
IC508	42	00	00	i G 03 04 50	" DN6838	"			
※ SW501	42	00	00	KA 90 10 70	Remote Rotary Switch	リモートロータリースイッチ			
	42	00	00	LA 00 21 10	Wrapping Terminal i Type P=52P	i型ラッピング端子板			
	42	00	00	LB 30 07 30	2.5 Pitch Base Pin TE3P-SHF	2.5ピッチベースピン			
	42	00	00	BA 07 28 30	Heat Sink #7283	放熱器			
	42	00	00	ED 33 00 80	Bind Head Screw 3 \times 8 FCM3-BI	鉄バインド小ネジ			
	42	00	00	LB 60 29 40	2.5 Pitch Base Pin TEB6P-SHF	2.5ピッチベースピン			

※ : New Part (新部品)

■PARTS LIST (Main C. Board)

K-850

Ref. No.	Part No.	Description	(部 品 名)	Remarks	Common model	Markets
	32:00:00 NA:07:42:00	MAIN CIRCUIT BOARD	メインシート			
C101	42:00:00 FA:15:31:50	Mylar Capacitor 0.0015 μ F 50V MS(K)	マイラーコン			
C102	42:00:00 FG:51:21:00	Ceramic Capacitor 100PF 50V SL(K)	セラコン			
C103	42:00:00 FG:51:21:00	Ceramic Capacitor 100PF 50V SL(K)	セラコン			
C104	42:00:00 UW:81:84:70	Electrolytic Capacitor 470 μ F 6.3V	ケミコン小形自立形			
C105	42:00:00 UW:83:73:30	" 33 μ F 16V	"			
C106	42:00:00 UW:83:73:30	" 33 μ F 16V	"			
C107	42:00:00 FG:51:11:00	Ceramic Capacitor 10PF 50V SL(K)	フォーミングセラコン			
C108	42:00:00 FG:51:11:00	Ceramic Capacitor 10PF 50V SL(K)	フォーミングセラコン			
C109	42:00:00 FA:15:41:20	Mylar Capacitor 0.012 μ F 50V MS(K)	マイラーコン			
C110	42:00:00 FA:15:41:20	Mylar Capacitor 0.012 μ F 50V MS(K)	マイラーコン			
C111	42:00:00 UW:86:61:00	Electrolytic Capacitor 1 μ F 50V	ケミコン小形自立形			
C112	42:00:00 UW:86:61:00	Electrolytic Capacitor 1 μ F 50V	ケミコン小形自立形			
C113	42:00:00 FA:15:36:80	Mylar Capacitor 0.0068 μ F 50V MS(J)	マイラーコン			
C114	42:00:00 FA:15:36:80	Mylar Capacitor 0.0068 μ F 50V MS(J)	マイラーコン			
C115	42:00:00 FZ:00:02:50	Electrolytic Capacitor 0.47 μ F 50V	ケミコン			
C116	42:00:00 FZ:00:02:50	Electrolytic Capacitor 0.47 μ F 50V	ケミコン			
C117	42:00:00 FA:15:31:00	Mylar Capacitor 0.001 μ F 50V MS(K)	マイラーコン			
C118	42:00:00 FA:15:31:00	Mylar Capacitor 0.001 μ F 50V MS(K)	マイラーコン			
C119	42:00:00 UW:86:64:70	Electrolytic Capacitor 4.7 μ F 50V	ケミコン小形自立形			
C120	42:00:00 UW:86:64:70	Electrolytic Capacitor 4.7 μ F 50V	ケミコン小形自立形			
C121	42:00:00 FA:11:32:70	Mylar Capacitor 0.0027 μ F 50V MS(K)	マイラーコン			
C122	42:00:00 FA:11:32:70	Mylar Capacitor 0.0027 μ F 50V MS(K)	マイラーコン			
C123	42:00:00 FA:11:44:70	" 0.047 μ F 50V MS(K)	"			
C124	42:00:00 FA:11:44:70	" 0.047 μ F 50V MS(K)	"			
C125	42:00:00 FM:52:53:30	Electrolytic Capacitor 0.33 μ F 50V	ケミコン			
C126	42:00:00 FM:52:53:30	Electrolytic Capacitor 0.33 μ F 50V	ケミコン			
C127	42:00:00 FA:15:44:70	Mylar Capacitor 0.1 μ F 50V MS(K)	マイラーコン			
C128	42:00:00 FA:15:44:70	Mylar Capacitor 0.1 μ F 50V MS(K)	マイラーコン			
C129	42:00:00 FA:11:51:00	" 0.0056 μ F 50V MS(J)	"			
C130	42:00:00 FA:11:51:00	" 0.0056 μ F 50V MS(J)	"			
C131	42:00:00 FA:15:42:70	" 0.027 μ F "	"			
C132	42:00:00 FA:15:42:70	" 0.027 μ F "	"			
C133	42:00:00 FA:15:34:70	" 0.0047 μ F 50V MS(K)	"			
C134	42:00:00 FA:15:34:70	" 0.0047 μ F 50V MS(K)	"			
C135	42:00:00 UW:84:71:00	Electrolytic Capacitor 10 μ F 25V	ケミコン小形自立形			
C136	42:00:00 UW:84:71:00	Electrolytic Capacitor 10 μ F 25V	ケミコン小形自立形			
C137	42:00:00 UW:83:82:20	" 220 μ F 16V	"			
C138	42:00:00 UW:83:82:20	" 220 μ F 16V	"			
C139	42:00:00 UW:84:71:00	" 10 μ F 25V	"			
C140	42:00:00 UW:84:71:00	" 10 μ F 25V	"			
C141	42:00:00 UW:86:54:70	" 0.47 μ F 50V	"			
C142	42:00:00 UW:86:54:70	" 0.47 μ F 50V	"			
C143	42:00:00 UW:84:71:00	" 10 μ F 25V	"			
C144	42:00:00 UW:84:71:00	" 10 μ F 25V	"			
C145	42:00:00 UW:86:61:00	" 1 μ F 50V	"			
C146	42:00:00 UW:86:61:00	" 1 μ F 50V	"			
C147	42:00:00 FM:52:54:70	" 0.47 μ F 50V	"			
C148	42:00:00 FM:52:54:70	" 0.47 μ F 50V	"			
C149	42:00:00 FM:11:61:00	Electrolytic Capacitor 1 μ F 50V	ハイポラケミコン			
C150	42:00:00 FM:11:61:00	Electrolytic Capacitor 1 μ F 50V	ハイポラケミコン			
C151	42:00:00 UW:83:81:00	" 100 μ F 16V	ケミコン小形自立形			
C152	42:00:00 UW:83:81:00	" 100 μ F 16V	ケミコン小形自立形			
C153	42:00:00 FA:15:41:80	Mylar Capacitor 0.018 μ F 50V MS(J)	マイラーコン			
C154	42:00:00 FA:15:41:80	Mylar Capacitor 0.018 μ F 50V MS(J)	マイラーコン			
C155	42:00:00 FA:15:43:90	" 0.039 μ F 50V MS(J)	マイラーコン			
C156	42:00:00 FA:15:43:90	" 0.039 μ F 50V MS(J)	マイラーコン			
C157	42:00:00 FA:15:35:60	" 0.0056 μ F "	"			
C158	42:00:00 FA:15:35:60	" 0.0056 μ F "	"			
C159	42:00:00 FG:51:28:20	Ceramic Capacitor 820PF 50V B(K)	フォーミングセラコン			
C160	42:00:00 FG:51:28:20	Ceramic Capacitor 820PF 50V B(K)	フォーミングセラコン			
C161	42:00:00 FU:15:21:80	Mica Capacitor 180PF 500V(J)	シルバードマイカコン			
C162	42:00:00 FU:15:21:80	Mica Capacitor 180PF 500V(J)	シルバードマイカコン			
C163	42:00:00 UW:86:61:00	Electrolytic Capacitor 1 μ F 50V	ケミコン小形自立形			
C164	42:00:00 UW:86:61:00	Electrolytic Capacitor 1 μ F 50V	ケミコン小形自立形			
C165	42:00:00 UW:84:71:00	" 10 μ F 25V	"			
C166	42:00:00 UW:84:71:00	" 10 μ F 25V	"			
C167	42:00:00 FG:54:41:00	Ceramic Capacitor 0.01 μ F 50V F(Z)	フォーミングセラコン			
C168	42:00:00 FG:54:41:00	Ceramic Capacitor 0.01 μ F 50V F(Z)	フォーミングセラコン			
C169	42:00:00 UW:84:71:00	Electrolytic Capacitor 10 μ F 25V	ケミコン小形自立形			
C170	42:00:00 UW:84:71:00	Electrolytic Capacitor 10 μ F 25V	ケミコン小形自立形			
C171	42:00:00 FG:54:41:00	Ceramic Capacitor 0.01 μ F 50V F(Z)	フォーミングセラコン			
C172	42:00:00 FG:54:41:00	Ceramic Capacitor 0.01 μ F 50V F(Z)	フォーミングセラコン			
C173	42:00:00 FG:54:41:00	Ceramic Capacitor 0.01 μ F 50V F(Z)	フォーミングセラコン			
C174	42:00:00 FG:54:41:00	Ceramic Capacitor 0.01 μ F 50V F(Z)	フォーミングセラコン			
C175	42:00:00 UW:84:71:00	Electrolytic Capacitor 10 μ F 25V	ケミコン小形自立形			
C176	42:00:00 UW:84:71:00	Electrolytic Capacitor 10 μ F 25V	ケミコン小形自立形			
C177	42:00:00 UW:84:71:00	" 10 μ F 25V	"			
C178	42:00:00 FG:54:41:00	Ceramic Capacitor 0.01 μ F 50V F(Z)	フォーミングセラコン			
C179	42:00:00 FG:54:41:00	Ceramic Capacitor 0.01 μ F 50V F(Z)	フォーミングセラコン			
C180	42:00:00 FG:54:41:00	Ceramic Capacitor 0.01 μ F 50V F(Z)	フォーミングセラコン			
C181	42:00:00 UW:84:71:00	Electrolytic Capacitor 10 μ F 25V	ケミコン小形自立形			
C182	42:00:00 FG:51:21:00	Ceramic Capacitor 100PF 50V SL(K)	フォーミングセラコン			
C183	42:00:00 UW:84:71:00	Electrolytic Capacitor 10 μ F 25V	ケミコン小形自立形			
C184	42:00:00 UW:84:71:00	Electrolytic Capacitor 10 μ F 25V	ケミコン小形自立形			
C185	42:00:00 FM:22:63:30	Electrolytic Capacitor 3.3 μ F 25V	ハイポラケミコン			
C186	42:00:00 FM:22:63:30	Electrolytic Capacitor 3.3 μ F 25V	ハイポラケミコン			
C187	42:00:00 FG:54:51:00	Ceramic Capacitor 0.1 μ F 50V FZ(Z)	フォーミングセラコン			
C188	42:00:00 FG:54:51:00	Ceramic Capacitor 0.1 μ F 50V FZ(Z)	フォーミングセラコン			
C189	42:00:00 FG:24:41:00	" 0.01 μ F "	"			
C190	42:00:00 FG:24:41:00	" 0.01 μ F "	"			
C191	42:00:00 FG:51:21:00	" 100PF 50V SL(K)	"			
C192	42:00:00 FG:51:21:00	" 100PF 50V SL(K)	"			
C193	42:00:00 UW:84:91:00	Electrolytic Capacitor 1000 μ F 25V	ケミコン			
C194	42:00:00 UW:84:91:00	Electrolytic Capacitor 1000 μ F 25V	ケミコン			
C195	42:00:00 UW:83:82:20	" 220 μ F 16V	"			
C196	42:00:00 UW:83:82:20	" 220 μ F 16V	"			
C197	42:00:00 UW:84:84:70	" 470 μ F 25V	"			
C198	42:00:00 UW:84:84:70	" 470 μ F 25V	"			
C199	42:00:00 UW:84:71:00	" 10 μ F 25V	"			
C200	42:00:00 UW:84:71:00	" 10 μ F 25V	"			
C201	42:00:00 FH:23:41:00	Ceramic Capacitor 0.01 μ F 500V YZ(P)	セラコン			
C202	42:00:00 FH:23:41:00	Ceramic Capacitor 0.01 μ F 500V YZ(P)	セラコン			
C203	42:00:00 UW:84:92:20	Electrolytic Capacitor 2200 μ F 25V	ケミコン小形自立形			
C204	42:00:00 UW:84:92:20	Electrolytic Capacitor 2200 μ F 25V	ケミコン小形自立形			
C205	42:00:00 UW:83:92:20	" 2200 μ F 16V	"			
C206	42:00:00 UW:83:92:20	" 2200 μ F 16V	"			
C207	42:00:00 UW:83:82:20	" 220 μ F 16V	"			
C208	42:00:00 UW:83:82:20	" 220 μ F 16V	"			
C209	42:00:00 UW:83:84:70	" 470 μ F 16V	"			
C210	42:00:00 UW:83:84:70	" 470 μ F 16V	"			
C211	42:00:00 FG:54:41:00	Ceramic Capacitor 0.01 μ F 50V F(Z)	フォーミングセラコン			
C212	42:00:00 FG:54:41:00	Ceramic Capacitor 0.01 μ F 50V F(Z)	フォーミングセラコン			

※ : New Part (新部品)

Ref. No.	Part No.	Description	(部 品 名)	Remarks	Common model	Markets
C316	42 00 00 UW 83 84 70	Electrolytic Capacitor 470 μ F 16V	ケミコン小形自立形			
C317	42 00 00 FG 54 41 00	Ceramic Capacitor 0.01 μ F 50V F(Z)	フォーミングセラコン			
C401 C402	42 00 00 UW 86 61 00	Electrolytic Capacitor 1 μ F 50V	ケミコン小形自立形			
C403 C404	42 00 00 UW 84 71 00	" 10 μ F 25V	"			
L101 L102	42 00 00 GE 20 02 20	Filter Coil GE20022	フィルターコイル			
L103 L104	42 00 00 GE 90 04 20	Bias Trap 1.8mH (J)	バイアストラップ			
L105 L106	42 00 00 GE 90 03 20	" GE90032	"			
L107	42 00 00 GE 90 03 00	Inductor 1mH	固定インダクター			
R101 R102	42 00 00 HJ 35 72 20	Carbon Resistor RD25 SM-8 22K Ω	カーボン抵抗			
R103 R110	42 00 00 HJ 35 71 00	" 10K Ω	"			
R111 R112	42 00 00 HJ 35 45 60	" 56 Ω	"			
R113 R114	42 00 00 HJ 35 71 00	" 10K Ω	"			
R115 R116	42 00 00 HJ 35 71 50	" 15K Ω	"			
R117 R118	42 00 00 HJ 35 61 20	" 1.2K Ω	"			
R119 R120	42 00 00 HJ 35 71 00	" 10K Ω	"			
R121 R122	42 00 00 HJ 35 82 70	" 270K Ω	"			
R123 R124	42 00 00 HJ 35 63 90	" 3.9K Ω	"			
R125 R126	42 00 00 HJ 35 71 00	" 10K Ω	"			
R127 R128	42 00 00 HJ 35 68 20	" 8.2K Ω	"			
R129 R130	42 00 00 HJ 35 81 00	" 100K Ω	"			
R131 R132	42 00 00 HJ 35 71 00	" 10K Ω	"			
R133 R134	42 00 00 HJ 35 72 20	" 22K Ω	"			
R135 R138	42 00 00 HJ 35 71 00	" 10K Ω	"			
R139 R140	42 00 00 HJ 35 91 00	" 1M Ω	"			
R141 R142	42 00 00 HJ 35 81 00	" 100K Ω	"			
R143 R144	42 00 00 HJ 35 71 00	" 10K Ω	"			
R145 R148	42 00 00 HJ 35 82 70	" 270K Ω	"			
R149 R150	42 00 00 HJ 35 81 80	" 180K Ω	"			
R151 R152	42 00 00 HJ 35 63 30	" 3.3K Ω	"			
R153 R154	42 00 00 HJ 35 51 80	" 180 Ω	"			
R155 R156	42 00 00 HJ 35 74 70	" 47K Ω	"			
R157 R160	42 00 00 HJ 35 61 00	" 1K Ω	"			
R161 R162	42 00 00 HJ 35 74 70	" 47K Ω	"			
R163 R164	42 00 00 HJ 35 61 00	" 1K Ω	"			
R165 R166	42 00 00 HJ 35 62 20	" 2.2K Ω	"			
R167 R168	42 00 00 HJ 35 71 50	" 15K Ω	"			
R169 R170	42 00 00 HJ 35 71 00	" 10K Ω	"			
R171 R172	42 00 00 HJ 35 52 70	" 270 Ω	"			
R173 R174	42 00 00 HJ 35 82 20	" 220K Ω	"			
R175 R176	42 00 00 HJ 35 63 90	" 3.9K Ω	"			
R177 R178	42 00 00 HJ 35 63 30	" 3.3K Ω	"			
R179 R180	42 00 00 HJ 35 72 20	" 22K Ω	"			
R181 R182	42 00 00 HJ 35 74 70	" 47K Ω	"			
R183 R184	42 00 00 HJ 35 71 00	" 10K Ω	"			
R185 R186	42 00 00 HJ 35 63 30	" 3.3K Ω	"			
R187 R188	42 00 00 HJ 35 41 00	" 10 Ω	"			
R189 R190	42 00 00 HJ 35 81 20	" 120K Ω	"			
R191 R192	42 00 00 HJ 35 62 20	" 2.2K Ω	"			
R193 R194	42 00 00 HJ 35 72 20	" 22K Ω	"			
R195 R198	42 00 00 HJ 35 71 00	" 10K Ω	"			
R199 R200	42 00 00 HJ 35 81 20	" 120K Ω	"			
R201 R202	42 00 00 HJ 35 61 20	" 1.2K Ω	"			
R203 R204	42 00 00 HJ 35 71 50	" 15K Ω	"			

※ : New Part (新部品)

Ref. No.	Part No.			Description	(部 品 名)	Remarks	Common model	Markets
R205 R206	42	00	00	HJ 35 61 20	Carbon Resistor RD25 SM-8 1.2K Ω	カーボン抵抗		
R207 R208	42	00	00	HJ 35 71 50	" 15K Ω	"		
R209 R212	42	00	00	HV 35 46 80	Flame Proof Carbon Resistor 68 Ω	不燃化カーボン抵抗		
R213 R214	42	00	00	HJ 35 51 00	Carbon Resistor RD25 SM-8 100 Ω	カーボン抵抗		
R215 R216	42	00	00	HJ 35 62 20	" 2.2K Ω	"		
R217 R218	42	00	00	HJ 35 68 20	" 8.2K Ω	"		
R219 R220	42	00	00	HJ 35 72 20	" 22K Ω	"		
R221 R222	42	00	00	HJ 35 71 00	" 10K Ω	"		
R223 R224	42	00	00	HJ 35 65 60	" 5.6K Ω	"		
R225 R228	42	00	00	HJ 35 56 80	" 680 Ω	"		
R229 R230	42	00	00	HJ 35 88 20	" 820K Ω	"		
R231 R232	42	00	00	HJ 35 64 70	" 4.7K Ω	"		
R233 R234	42	00	00	HJ 35 56 80	" 680 Ω	"		
R235 R236	42	00	00	HJ 35 81 50	" 150K Ω	"		
R237 R238	42	00	00	HJ 35 58 20	" 820 Ω	"		
R239 R240	42	00	00	HJ 35 63 30	" 3.3K Ω	"		
R241 R242	42	00	00	HJ 35 71 00	" 10K Ω	"		
R243 R244	42	00	00	HJ 35 44 70	" 47 Ω	"		
R245 R246	42	00	00	HJ 35 71 00	" 10K Ω	"		
R247 R248	42	00	00	HJ 35 72 20	" 22K Ω	"		
R249 R250	42	00	00	HJ 35 41 00	" 10 Ω	"		
R251	42	00	00	HJ 35 52 20	" 220 Ω	"		
R252	42	00	00	HJ 35 72 20	" 22K Ω	"		
R254	42	00	00	HJ 35 72 20	" 22K Ω	"		
R255	42	00	00	HJ 35 64 70	" 4.7K Ω	"		
R256	42	00	00	HJ 35 61 00	" 1K Ω	"		
R257	42	00	00	HJ 35 63 90	" 3.9K Ω	"		
R258	42	00	00	HJ 35 71 00	" 10K Ω	"		
R259	42	00	00	HJ 35 81 00	" 100K Ω	"		
R260	42	00	00	HJ 35 71 00	" 10K Ω	"		
R261	42	00	00	HJ 35 63 90	" 3.9K Ω	"		
R262	42	00	00	HJ 35 61 20	" 1.2K Ω	"		
R263	42	00	00	HJ 35 56 80	" 680 Ω	"		
R264	42	00	00	HJ 35 61 20	" 1.2K Ω	"		
R265 R266	42	00	00	HJ 35 71 00	" 10K Ω	"		
R267	42	00	00	HJ 35 56 80	" 680 Ω	"		
R268	42	00	00	HJ 35 81 00	" 100K Ω	"		
R269	42	00	00	HJ 35 61 20	" 1.2K Ω	"		
R270	42	00	00	HJ 35 71 00	" 10K Ω	"		
R272	42	00	00	HJ 35 61 00	" 1K Ω	"		
R273	42	00	00	HJ 35 71 00	" 10K Ω	"		
R274	42	00	00	HJ 35 81 00	" 100K Ω	"		
R275 R277	42	00	00	HJ 35 71 00	" 10K Ω	"		
R278	42	00	00	HJ 35 62 20	" 2.2K Ω	"		
R279	42	00	00	HJ 35 71 00	" 10K Ω	"		
R280	42	00	00	HJ 35 71 50	" 15K Ω	"		
R281	42	00	00	HJ 35 74 70	" 47K Ω	"		
R282 R286	42	00	00	HJ 35 71 00	" 10K Ω	"		
R287	42	00	00	HJ 35 61 20	" 1.2K Ω	"		
R288	42	00	00	HJ 35 58 20	" 820 Ω	"		
R290	42	00	00	HJ 35 61 00	" 1K Ω	"		
R295 R296	42	00	00	HJ 35 64 70	" 4.7K Ω	"		
R297	42	00	00	HJ 35 81 00	" 100K Ω	"		

※ : New Part (新部品)

Ref. No.	Part No.				Description	(部 品 名)	Remarks	Common model	Markets
R299	42:00:00	HJ 35 72 20	Carbon Resistor RD25 SM-8 22K Ω		カーボン抵抗				
R301	42:00:00	HL 41 56 80	Metal Oxide Film Resistor 1P 680 Ω		酸化抵抗				
R302	42:00:00	HG 30 53 30	Carbon Resistor RD50S 330 Ω		カーボン抵抗				
R303	42:00:00	HL 41 56 80	Metal Oxide Film Resistor 1P 680 Ω		酸化抵抗				
R304	42:00:00	HG 30 53 30	Carbon Resistor RD50S 330 Ω		カーボン抵抗				
R305	42:00:00	HG 30 61 00	" 1K Ω		"				
R306	42:00:00	HL 41 62 70	Metal Oxide Film Resistor 1P 2.7K Ω		酸化抵抗				
R307	42:00:00	HL 42 51 00	" 2P 100 Ω		"				
R308 R309	42:00:00	HJ 35 61 00	Carbon Resistor RD25 SM-8 1K Ω		カーボン抵抗				
R310 R311	42:00:00	HL 42 51 50	Metal Oxide Film Resistor 2P 150 Ω		酸化抵抗				
R321 R322	42:00:00	HJ 35 72 20	Carbon Resistor RD25 SM-8 22K Ω		カーボン抵抗				
R401 R402	42:00:00	HJ 35 63 30	" 3.3K Ω		"				
R403 R404	42:00:00	HJ 35 52 20	" 220 Ω		"				
R405 R406	42:00:00	HJ 35 71 50	" 15K Ω		"				
VR101 VR102	42:00:00	HT 37 00 80	Semi Variable Resistor B20K Ω		半固定VR				
"	42:00:00	HT 77 00 70	" KVSF8-7PNF B20K Ω		"	Inter-changeable			
VR103	42:00:00	HS 41 10 50	Variable Resistor ϕ 16 50KA Ω		VR 2連2軸				
VR105	42:00:00	HS 31 09 50	" ϕ 16 10KB Ω		" 2連				
VR107 -110	42:00:00	HT 37 00 50	Semi Variable Resistor V8 B5K Ω		半固定VR				
"	42:00:00	HT 77 00 50	" KVSF8-7PNF B5K Ω		"	Inter-changeable			
VR111 VR112	42:00:00	HT 77 00 80	" B20K Ω		"	Inter-changeable			
"	42:00:00	HT 77 00 70	" KVSF8-7PNF B20K Ω		"	Inter-changeable			
VR113 VR114	42:00:00	HT 77 00 80	" B50K Ω		"	Inter-changeable			
"	42:00:00	HT 37 01 00	" B50K Ω		"	Inter-changeable			
VR115	42:00:00	HT 37 00 50	" B5K Ω		"	Inter-changeable			
"	42:00:00	HT 77 00 50	" KVSF8-7PNF B5K Ω		"	Inter-changeable			
VR116	42:00:00	HT 77 00 60	" B10K Ω		"	Inter-changeable			
"	42:00:00	HT 37 00 20	" B10K Ω		"	Inter-changeable			
VR117	42:00:00	HT 41 03 10	" B47K Ω		"				
Tr101 Tr102	42:00:00	i C 25 00 00	Transistor 2SC2500		トランジスタ				
Tr103 Tr106	42:00:00	i D 07 86 00	" 2SD786(Q,R,S)		"				
Tr107 Tr108	42:00:00	i C 23 20 10	" 2SC2320(E)(F)		"				
Tr109 Tr110	42:00:00	i E 10 05 40	" 2SK68A(N)		"				
Tr111 Tr112	42:00:00	i B 07 37 00	" 2SB737(Q,R,S)		"				
Tr113 Tr116	42:00:00	i A 09 99 10	" 2SA999(E)(F)		"				
Tr117 Tr122	42:00:00	i C 23 20 10	" 2SC2320(E)(F)		"				
Tr123	42:00:00	i D 06 55 00	" 2SD655(D)(E)(F)		"				
Tr124	42:00:00	i C 25 00 00	" 2SC2500		"				
Tr125 Tr130	42:00:00	i C 23 20 10	" 2SC2320(E)(F)		"				
Tr131 Tr132	42:00:00	i A 09 99 10	" 2SA999(E)(F)		"				
Tr133 Tr134	42:00:00	i C 23 20 10	" 2SC2320(E)(F)		"				
Tr135 Tr136	42:00:00	i C 25 00 00	" 2SC2500		"				
Tr137 Tr138	42:00:00	i C 23 20 30	" 2SC2320(L)		"				
Tr139 Tr140	42:00:00	i C 23 20 10	" 2SC2320(E)(F)		"				
Tr141	42:00:00	i D 04 00 00	" 2SD400		"				
Tr142 Tr143	42:00:00	i C 23 20 10	" 2SC2320(E)(F)		"				
Tr144	42:00:00	i A 09 99 10	" 2SA999(E)(F)		"				
Tr145	42:00:00	i C 23 20 10	" 2SC2320(E)(F)		"				
Tr146	42:00:00	i A 09 99 10	" 2SA999(E)(F)		"				
Tr147	42:00:00	i C 23 20 10	" 2SC2320(E)(F)		"				
Tr148	42:00:00	i A 09 99 10	" 2SA999(E)(F)		"				
Tr149 Tr152	42:00:00	i C 23 20 10	" 2SC2320(E)(F)		"				
Tr153 Tr154	42:00:00	i A 09 99 10	" 2SA999(E)(F)		"				

*: New Part (新部品)

■PARTS LIST (LED C. Board) (Relay C. Board)

Ref. No.	Part No.	Description	(部 品 名)	Remarks	Common model	Markets
Tr155 Tr156	42:00:00 i C:23:20:10	Transistor 2SC2320(E)(F)	"			
Tr157	42:00:00 i A:09:99:10	" 2SA999(E)(F)	"			
Tr301	42:00:00 i C:12:12:00	" 2SC1212A(C)	"			
Tr302	42:00:00 i B:05:44:10	" 2SB544	"			
Tr303 Tr304	42:00:00 i D:04:76:10	" 2SD476(B)(C)	"			
D101 D104	42:00:00 i F:00:00:40	Diode 1S1555	ダイオード			
D105	42:00:00 i F:00:15:70	Zener Diode HZ12B3	ツェナーダイオード			
D106 D109	42:00:00 i F:00:00:40	Diode 1S1555	ダイオード			
D110	42:00:00 i F:00:06:40	Zener Diode HZ7B	ツェナーダイオード			
D301	42:00:00 i H:00:04:70	Diode 1D4B1	ダイオード			
D302 D303	42:00:00 i H:00:05:90	" 10E-1	"			
D304 D305	42:00:00 i H:00:04:70	" 1D4B1	"			
D306	42:00:00 i F:00:15:70	Zener Diode HZ12B3	ツェナーダイオード			
* D307	42:00:00 i F:00:19:60	" HZ12B-1	"			
D308	42:00:00 i F:00:15:70	" HZ12B3	"			
IC101 IC102	42:00:00 i G:03:74:00	IC μPD4066C	IC			
IC103 IC104	42:00:00 i G:03:46:00	" NE646B	"			
IC105 IC107	42:00:00 i G:03:47:00	" AN6551	"			
IC108	42:00:00 i G:03:93:00	" OSC BLOCK	"			
IC401	42:00:00 i G:02:84:00	" MJM4558DY	"			
* SW101	42:00:00 KA:80:14:80	Push Switch 2-2	プッシュSW単動			
* SW102	42:00:00 KA:80:14:90	" 2-2	" 連動			
* SW103	42:00:00 KA:40:06:40	Slide Switch 1-2	スライドSW			
F101 F103	42:00:00 KB:00:10:30	Fuse UL SS-2 2.0A 250V	ヒューズ			U,C
F101 F104	42:00:00 KB:00:03:50	" 2.0A 250V	"			J,R,A
"	42:00:00 KB:00:07:40	" S 1.25AT 250V	"			G,B
F104	42:00:00 KB:00:10:40	" UL SS-2 3.0A 250V	"			U,C
* JK401 JK402	42:00:00 LB:30:11:60	Microphone Jack (White)	マイクジャック			
JK403	42:00:00 LB:30:10:40	Head Phone Jack S-G2218(White)	ヘッドホンジャック			
PJ101	42:00:00 LB:40:05:80	Pin Jack 4P	4Pピンジャック			
	32:00:00 BA:06:77:80	Heat Sink #6778	放熱板			
	32:00:00 BA:07:72:90	" #7729	"			
	42:00:00 LA:00:25:50	Wrapping Terminal i type P=5(O) 3P	i型ラッピング端子板			
	42:00:00 LA:00:21:10	" P=5 2P	"			
	42:00:00 LA:00:21:20	" P=5 3P	"			
	42:00:00 LA:00:23:30	" P=7.5 4P	"			
	42:00:00 LA:00:21:50	" P=10 3P	"			
	42:00:00 LA:00:25:60	" P=7.5(O) 2P	"			
* 42:00:00 LB:20:09:00	Fuse Holder Pin PC YSH402P	ヒューズホルダーピン				J,R,U,A,C
* 42:00:00 LB:20:10:60	" YSH403P	"				G,B
42:00:00 LB:20:13:90	2.5 Pitch Base Pin B2P-SHF	2.5ピッチベースピン				
42:00:00 LB:40:05:70	" B4P-SHF	"				
42:00:00 EA:03:00:60	Pan Head Screw 3×6(ZMC2-Y)	ナベ小ネジ				
42:00:00 Ei:03:00:60	Bind Head Tapping Screw 3×6(")	バインドタッピングネジ				
* 32:00:00 NA:07:42:60	LED CIRCUIT BOARD	LEDシート				
D601	42:00:00 i F:00:12:70	LED (Green) SLP-237B	LED (緑)			
D602	42:00:00 i F:00:12:60	" (Red) SLP-137B	" (赤)			
D603	42:00:00 i F:00:12:70	" (Green) SLP-237B	" (緑)			
* 32:00:00 CB:09:35:40	Holder, L.E.D #9354	LEDホルダー				
* 42:00:00 EK:03:50:60	B.W Bind Head Tapping Screw Type II 2.6×8(ZMC2-Y)	鉄B.Wヘッド タッピングネジ2種				

* : New Part (新部品)

