

MULTITRACK CASSETTE RECORDER

MT400

SERVICE MANUAL

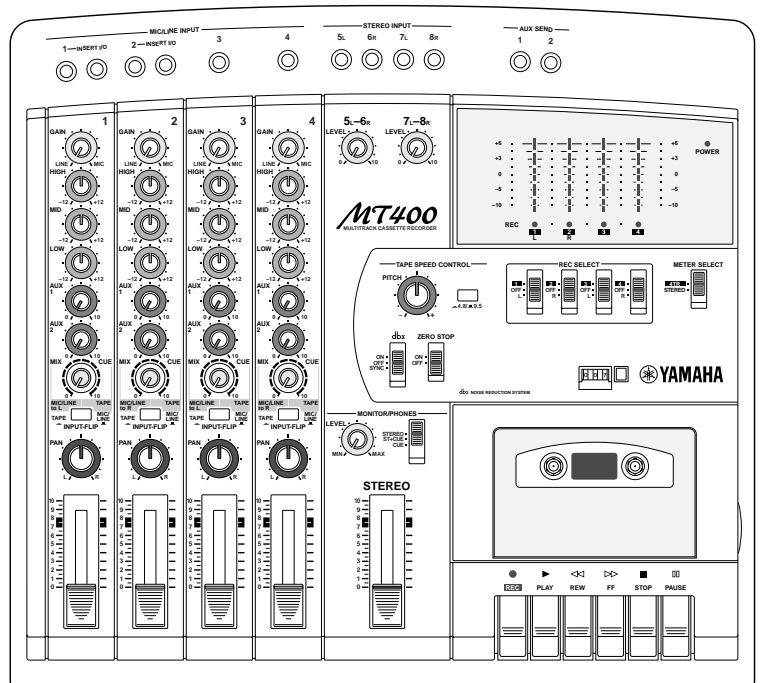

■ CONTENTS

SPECIFICATIONS	3/4
DIMENSIONS	4
PANEL LAYOUT	5
CIRCUIT BOARD LAYOUT	8
BLOCK DIAGRAM	9
DISASSEMBLY PROCEDURE	10
IC BLOCK DIAGRAM	11
CIRCUIT BOARDS	12
INSPECTIONS	15/17
TROUBLE SHOOTING	19
CIRCUIT DIAGRAM	21
PARTS LIST	

IMPORTANT NOTICE

This manual has been provided for the use of authorized Yamaha Retailers and their service personnel. It has been assumed that basic service procedures inherent to the industry, and more specifically Yamaha Products, are already known and understood by the users, and have therefore not been restated.

WARNING : Failure to follow appropriate service and safety procedures when servicing this product may result in personal injury, destruction of expensive components and failure of the product to perform as specified. For these reasons, we advise all Yamaha product owners that all service required should be performed by an authorized Yamaha Retailer or the appointed service representative.

IMPORTANT : This presentation or sale of this manual to any individual or firm does not constitute authorization certification, recognition of any applicable technical capabilities, or establish a principal-agent relationship of any form.

The data provided is believed to be accurate and applicable to the unit(s) indicated on the cover. The research engineering, and service departments of Yamaha are continually striving to improve Yamaha products. Modifications are, therefore, inevitable and changes in specification are subject to change without notice or obligation to retrofit. Should any discrepancy appear to exist, please contact the distributor's Service Division.

WARNING : Static discharges can destroy expensive components. Discharge any static electricity you body may have accumulated by grounding yourself to the ground buss in the unit (heavy gauge black wires connect to this buss.)

IMPORTANT : Turn the unit OFF during disassembly and parts replacement. Recheck all work before you apply power to the unit.

WARNING: CHEMICAL CONTENT NOTICE!

The solder used in the production of this product contains LEAD. In addition, other electrical/electronic and/or plastic (Where applicable) components may also contain traces of chemicals found by the California Health and Welfare Agency (and possibly other entities) to cause cancer and/or birth defects or other reproductive harm.

DO NOT PLACE SOLDER, ELECTRICAL/ELECTRONIC OR PLASTIC COMPONENTS IN YOUR MOUTH FOR ANY REASON WHAT SO EVER!

Avoid prolonged, unprotected contact between solder and your skin! When soldering, do not inhale solder fumes or expose eyes to solder/flux vapor!

If you come in contact with solder or components located inside the enclosure of this product, wash your hands before handling food.

WARNING

Components having special characteristics are marked  and must be replaced with parts having specification equal to those originally installed.

SPECIFICATIONS

Tape Transport

Tape Type	C46–90 cassette tapes (Type II)
Track Configuration	4-track/4-channel, One-way Record-Play
Tape Heads	4-track Record-Play, Hard Permalloy x 1, 4-track Erase, Ferrite x1
Motor	DC servo motor x1
Tape Speed	4.8 cm/s, 9.5 cm/s
Pitch Control	Approximately+/-10%
Wow & Flutter	0.12% WRMS (9.5 cm/s)
Rewind Time	Approximately 120 seconds for a C60 tape

Mixer

Frequency Response	20 Hz–20 kHz, +1/-4 dB, MIC IN—STEREO OUT LINE IN—MONITOR OUT
S/N Ratio (at rated input & output levels)	65 dB/IHF-A, MIC IN—STEREO OUT (GAIN TRIM MAX) 70 dB/IHF-A, LINE IN—STEREO OUT (GAIN TRIM MIN)
EQ	LOW/Shelving Basic frequency: 80 Hz, Range: ±12 dB MID/Peaking Basic frequency: 1 kHz, Range: ±12 dB HIGH/Shelving Basic frequency: 12 kHz, Range: ±12 dB

Recorder

Overall Frequency Response	50 Hz–14 kHz, +3/-5 dB (9.5 cm/s, NR OUT)
Overall S/N Ratio	80 dB/IHF-A (NR IN) [at 3% distortion level]
Overall Distortion	2.0% (400 Hz, -10 dB)
Erasure Rate	55 dB (1 kHz, 0 dB, BPF)
Noise Reduction	dbx TYPE II

Connections

# of I/Os	MIC/LINE x4 INSERT I/O x2 STEREO IN x2 AUX SEND x2 STEREO OUT L, R x1 MONITOR OUT L, R x1 SYNC OUT x1 PHONES L, R x1
-----------	--

I/O Specifications

MIC/LINE	Input Impedance: 10 k ohm Rated Input Level: -10 to -50 dB (CH fader at rated levels) Minimum Input Level: -56 dB (Gain trim max. CH fader max)
INSERT IN CH 1, 2	Input Impedance: 10 k ohm Rated Input Level: -10 dB (CH fader at rated levels) Minimum Input Level: -16 dB (CH fader max)
STEREO IN	Input Impedance: 10 k ohm Rated Input Level: -10 dB (CH fader at rated levels) Minimum Input Level: -16 dB (Volume max)
INSERT OUT CH 1, 2	Output Impedance: 100ohm Rated Load Impedance: 10 kΩ or higher Rated Output Level: -10 dB (10 kΩ load)

STEREO OUT L, R	Output Impedance: 1 k ohm Rated Load Impedance: 10 k ohm or higher Rated Output Level: -10 dB (10 k ohm load)
AUX SEND	Output Impedance: 1 k ohm Rated Load Impedance: 10 k ohm or higher Rated Output Level: -10 dB (10 k ohm load)
MONITOR OUT	Output Impedance: 1 k ohm Rated Load Impedance: 10 k ohm or higher Rated Output Level: -10 dB (10 k ohm load)
SYNC OUT	Output Impedance: 1 k ohm Rated Load Impedance: 10 k ohm or higher Rated Output Level: -10 dB (10 k ohm load)
PHONES (STEREO)	Rated Load Impedance: 8 to 40ohm Rated Output Level: 30 mW+30 mW (40ohm load)

Control Jack

PUNCH I/O	Foot switch: FC5 (optional)
-----------	-----------------------------

General

Power Requirement	DC 12V (650 mA or higher)
Dimensions (WxHxD)	388 x 102 x 354 mm
Weight	2.8 kg
Option for UK model	AC adapter KPA4N, KPA6N

0 dB=0.775 Vrms.

■ DIMENSIONS

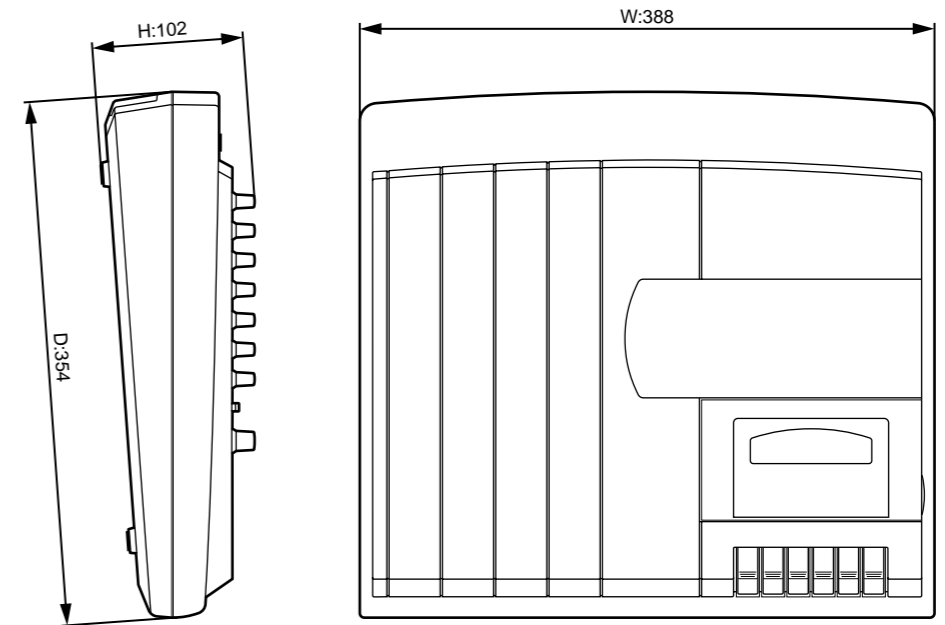

Unit : mm

PANEL LAYOUT

• Input channels

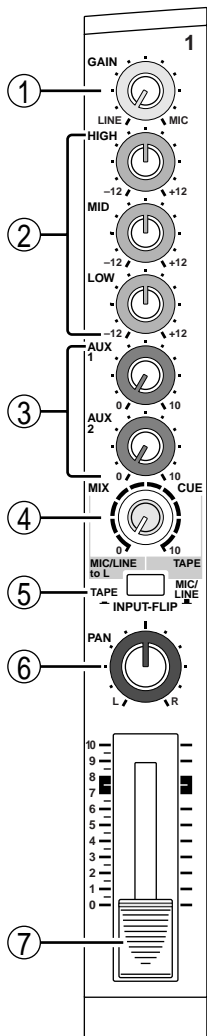

- ① GAIN control
- ② EQ control
- ③ AUX controls
- ④ CUE control
- ⑤ INPUT-FLIP switch
- ⑥ PAN control
- ⑦ Fader

• Stereo Input

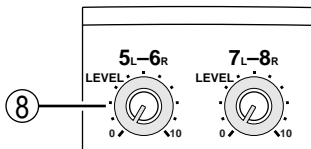

- ⑧ LEVEL controls

• Monitor / Master Section

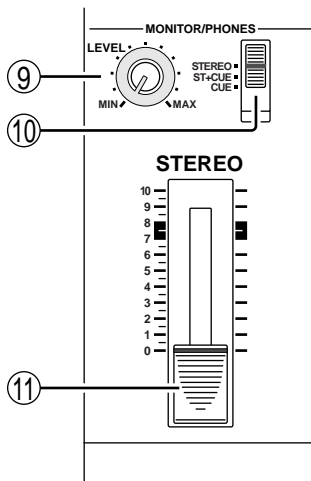

- ⑨ MONITOR LEVEL control
- ⑩ MONITOR select switch
- ⑪ STEREO fader

• Recorder Section

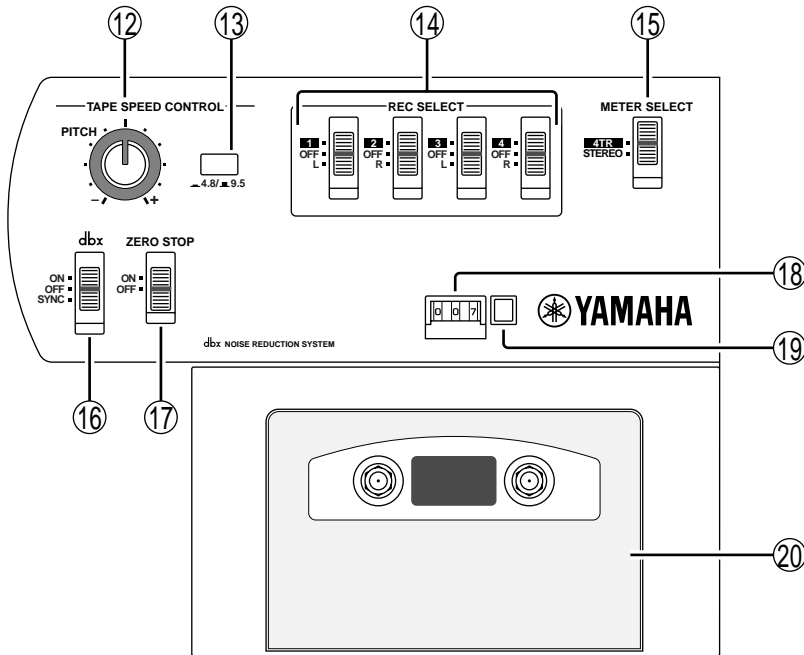

- ⑫ PITCH control
- ⑬ Tape speed switch
- ⑭ REC SELECT switches
- ⑮ METER SELECT switch
- ⑯ dbx switch
- ⑰ ZERO STOP switch
- ⑱ Tape counter
- ⑲ Counter reset button
- ⑳ Cassette compartment

• Transport Section

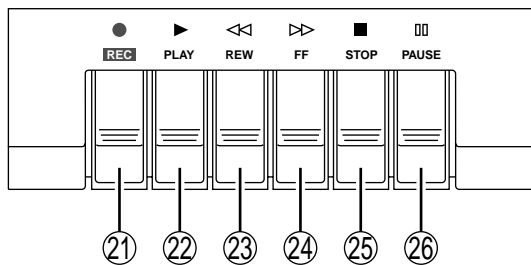

- ⑲ **REC** button (●)
- ⑳ **PLAY** button (▶)
- ㉑ **REW** button (◀◀)
- ㉒ **FF** button (▶▶)
- ㉓ **STOP** button (■)
- ㉔ **PAUSE** button (▯▯)

• Meter Section

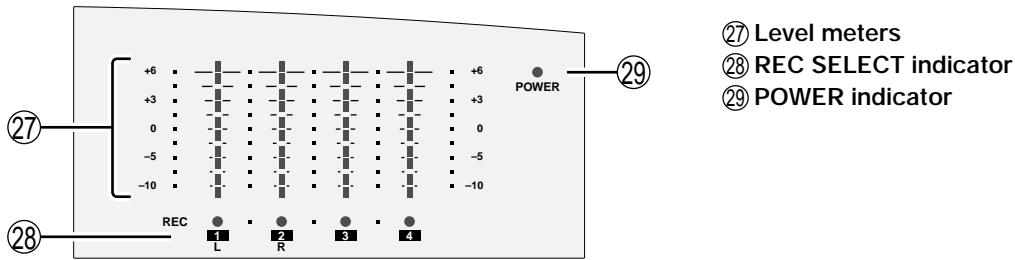

• Input / Output Section

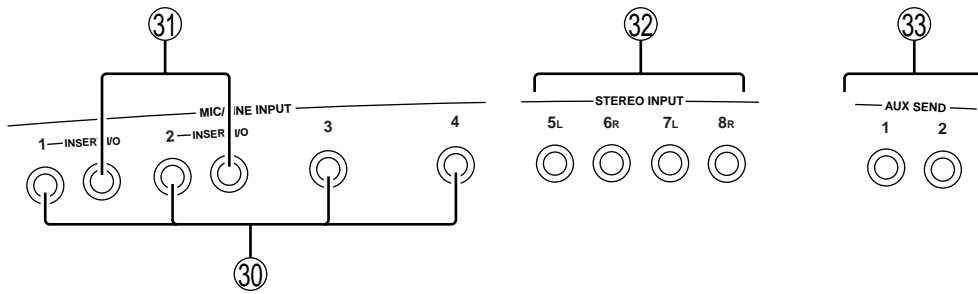

- ③⑩ MIC/LINE INPUTs 1-4
- ③⑪ INSERT I/O
- ③⑫ STEREO INPUTs
- ③⑬ AUX SEND

• Front Panel



• Rear Panel

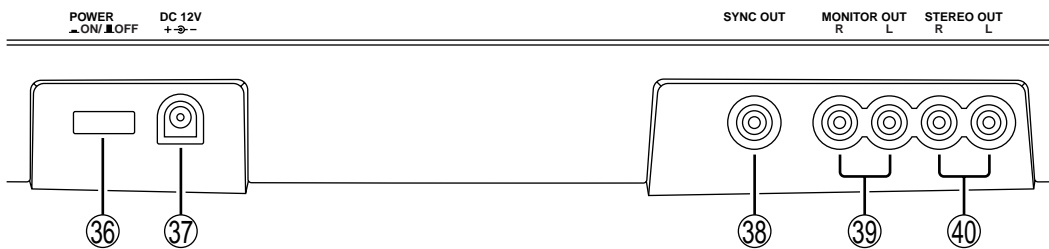

- ③⑥ POWER ON/OFF switch
- ③⑦ DC 12V
- ③⑧ SYNC OUT
- ③⑨ MONITOR OUTs
- ④⑩ STEREO OUTs

CIRCUIT BOARD LAYOUT

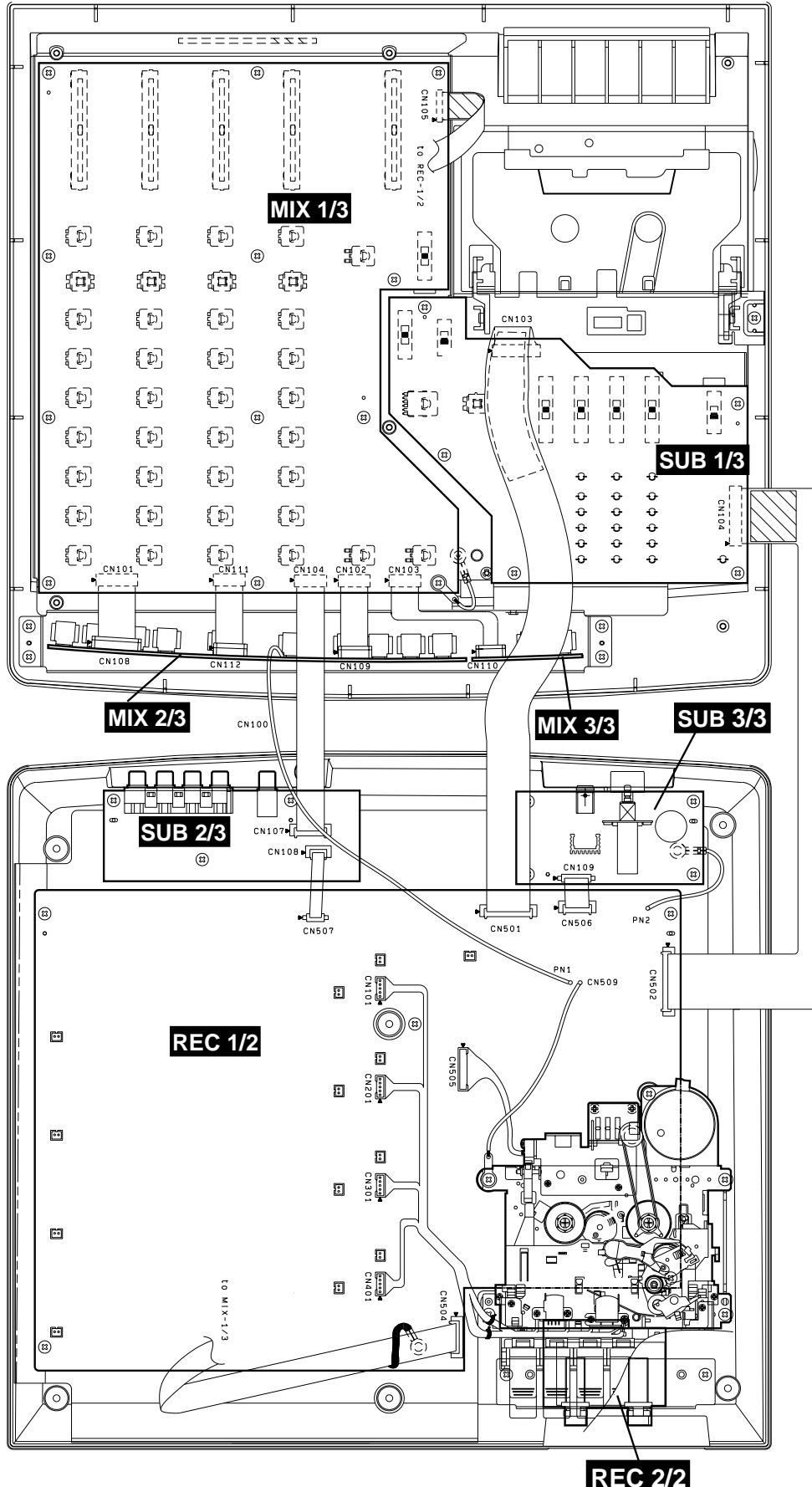

BLOCK DIAGRAM

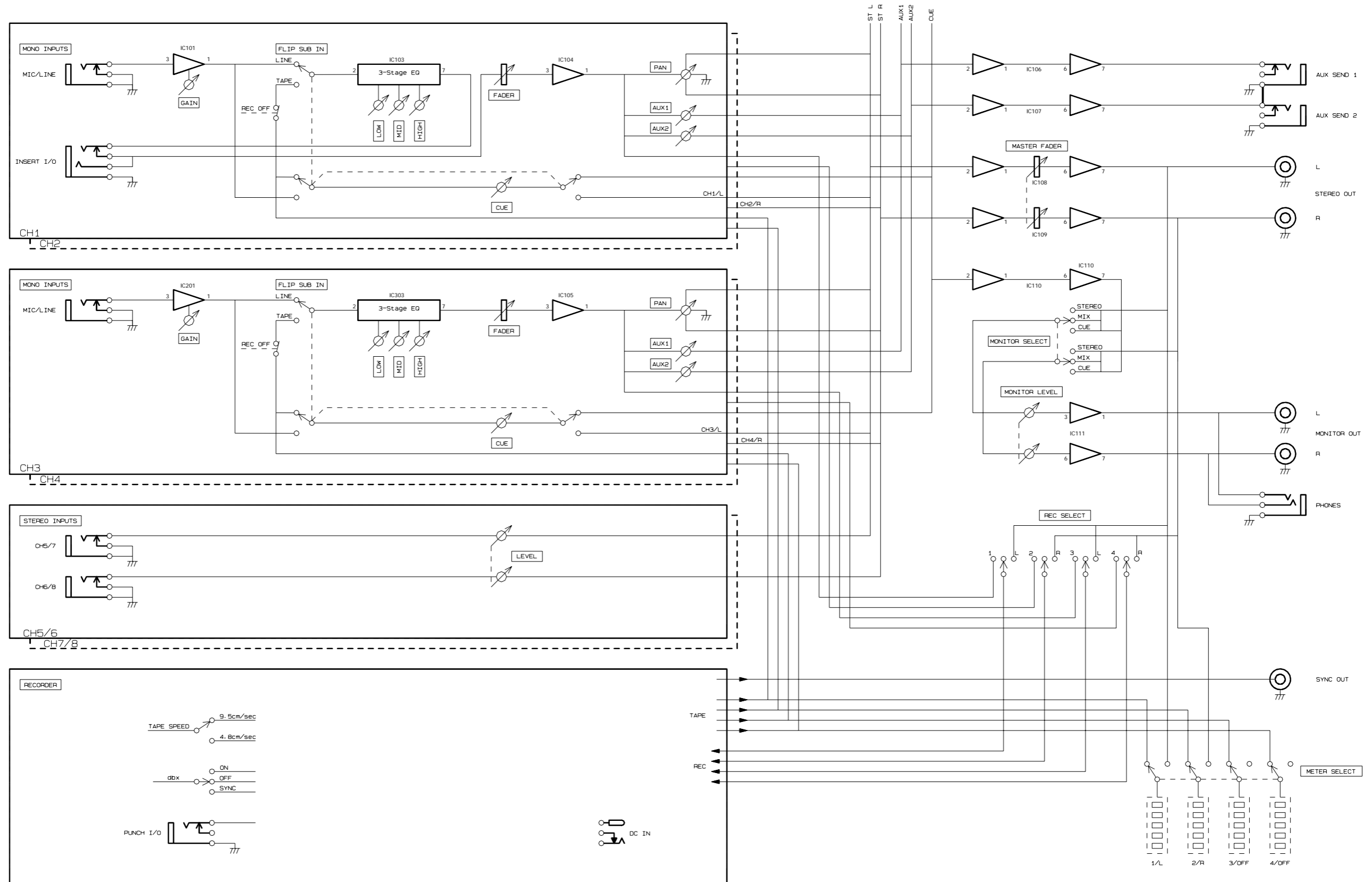

DISASSEMBLY PROCEDURE

1. Lower Case

- 1-1 Remove the seven (7) screws marked [320]. The lower case can then be removed. (Fig.1)

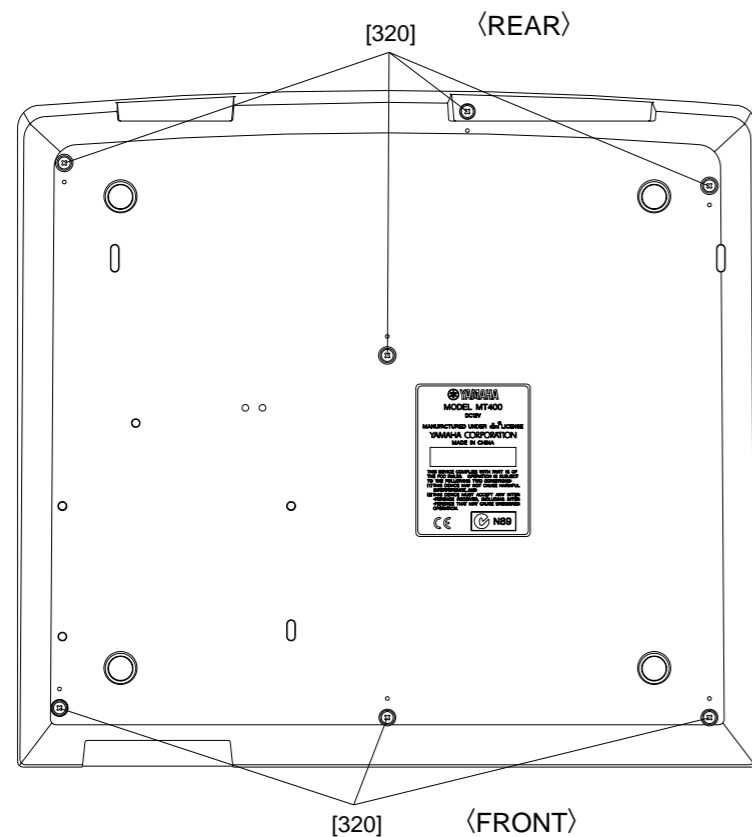

[320]: Bind Head Tapping Screw-P 3X10 MFZN2BL (EP630660)

Fig.1

2. Cassette Mechanism

- 2-1 Remove the lower case. (See Procedure 1.)
 2-2 Remove the five (5) screws marked [320a]. The cassette mechanism can then be removed. (Fig. 2)

3. REC 1/2, 2/2 Circuit Boards

- 3-1 Remove the lower case. (See Procedure 1.)
 3-2 Remove the cassette mechanism. (See Procedure 2.)
 3-3 Remove the six (6) screws marked [320b]. The REC 1/2 circuit board can then be removed. (Fig.2)
 3-4 Remove the two (2) screws marked [320c]. The REC 2/2 circuit board can then be removed. (Fig.2)

4. SUB 2/3, 3/3 Circuit Boards

- 4-1 Remove the lower case. (See Procedure 1.)
 4-2 Remove the three (3) screws marked [320d] and the two (2) screws marked [320e]. The SUB2/3 circuit board can then be removed. (Fig.2, Fig.3)
 4-3 Remove the four (4) screws marked [320f]. The SUB 3/3 circuit board can then be removed. (Fig.2)

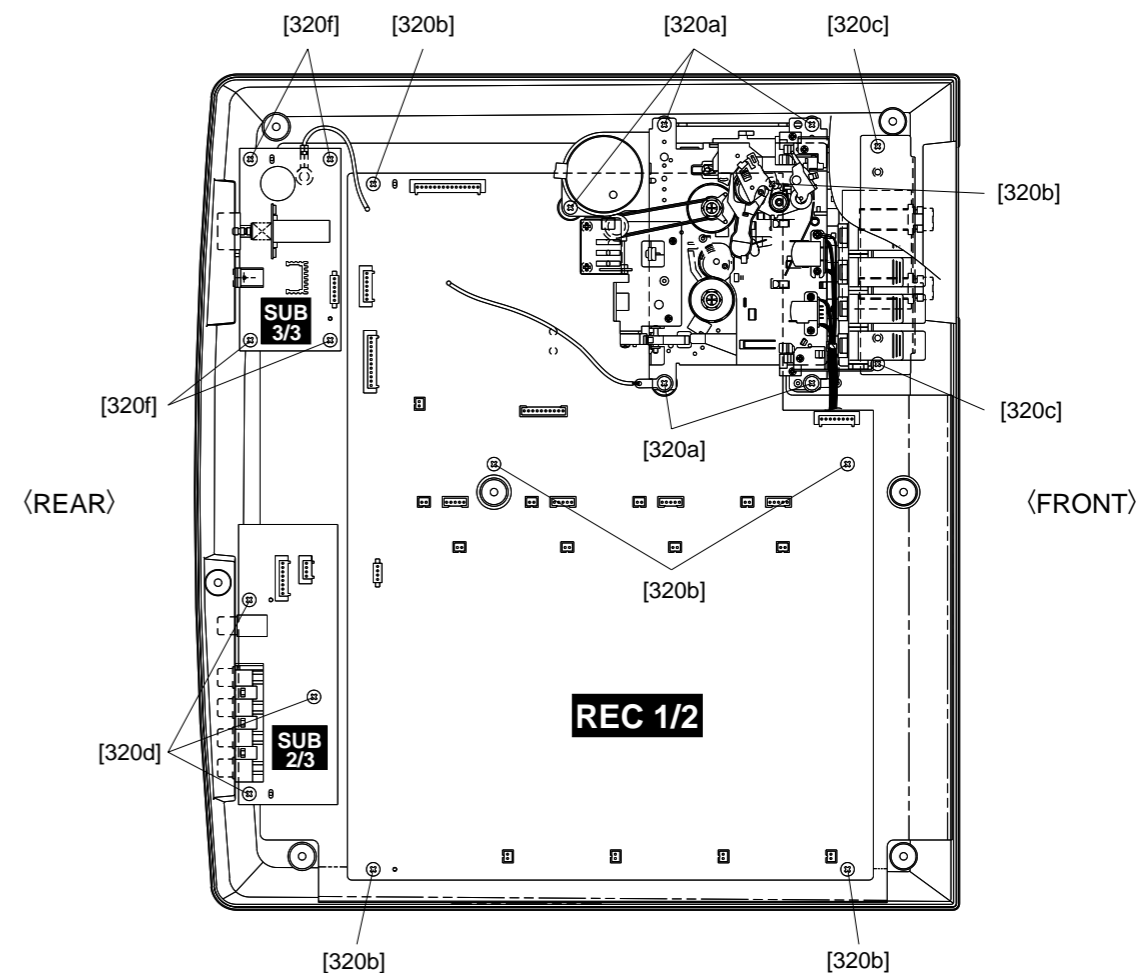

Fig.2

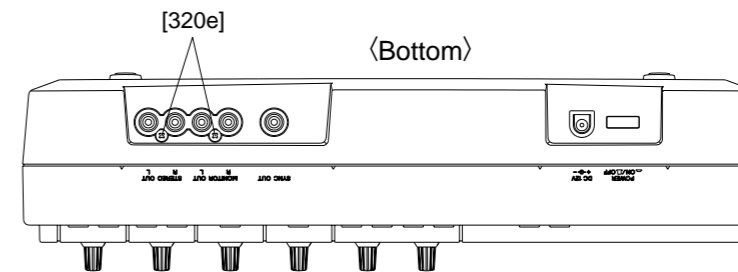

Fig.3

IC BLOCK DIAGRAM

5. SUB 1/3 Circuit Board

- 5-1 Remove the lower case. (See Procedure 1.)
- 5-2 Remove the PITCH knob of the TAPE SPEED CONTROL on the upper case and the six (6) screws marked [320g].
The SUB 1/3 circuit board can then be removed. (Fig.4)

6. MIX 1/3 Circuit Board

- 6-1 Remove the lower case. (See Procedure 1.)
- 6-2 Remove the SUB 1/3 circuit board. (See Procedure 5.)
- 6-3 Remove the knob on the upper case and the twelve (12) screws marked [320h].
The MIX 1/3 circuit board can then be removed. (Fig.4)

7. MIX 2/3, 3/3 Circuit Boards

- 7-1 Remove the lower case. (See Procedure 1.)
- 7-2 Remove the four (4) screws marked [320i] on the plate. The plate with the MIX 2/3 and 3/3 circuit boards can then be removed. (Fig.4)
- 7-3 Remove the holding plate of each jack. The each circuit board can then be removed.

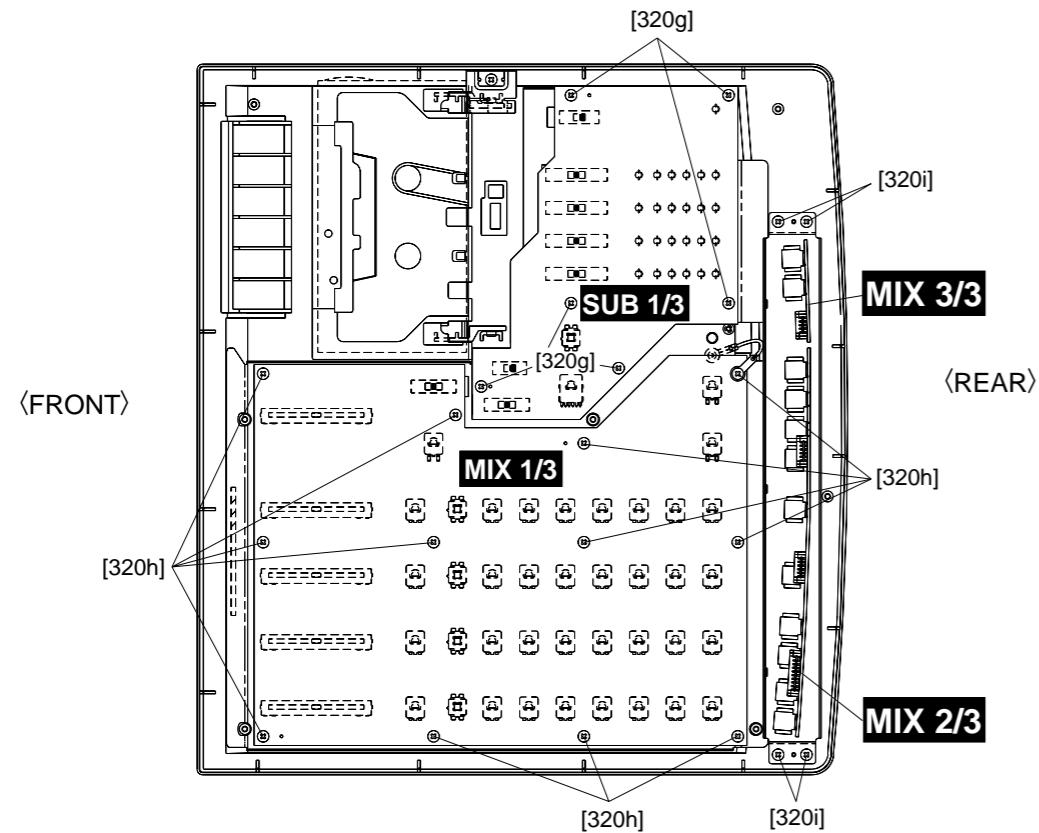
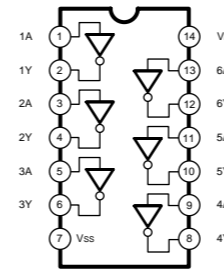
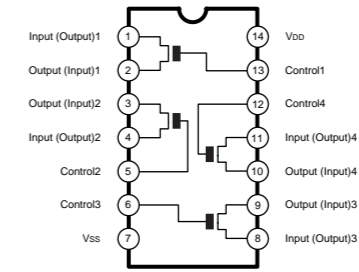

Fig.4

- **TC4069UBP**(IG001720)
Hex Inverter



- **TC4066BP**(IX631591)
Quad Bilateral Switch



- **NJM2068LD**(XM356A00)
NJM4558L(IX614610)
M5216L(XB419A00)
M5218AL(XH471A00)
Dual Operational Amplifier

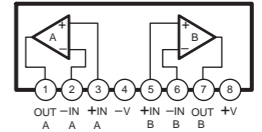

- **AN6292NK**(XJ637A00)
Dual dbx NR

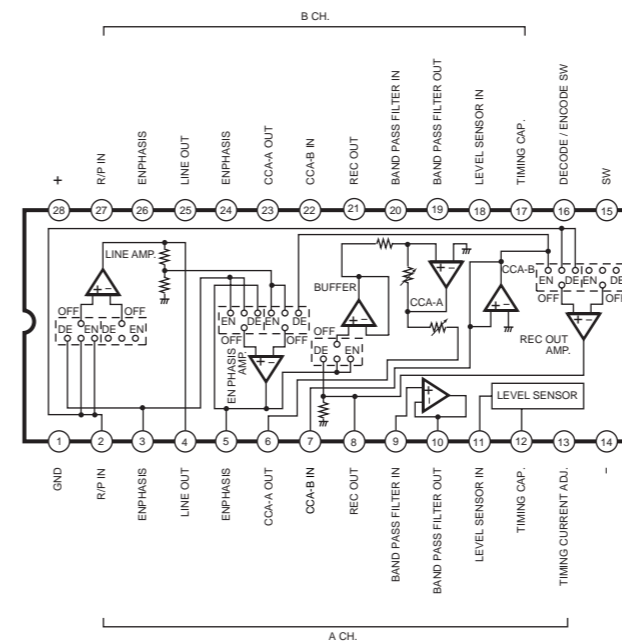

- **BA7755A**(XH519A00)
Head Switcher

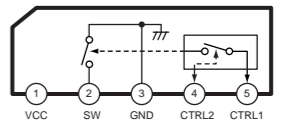

- **BA6137**(XA534A00)
LED Driver

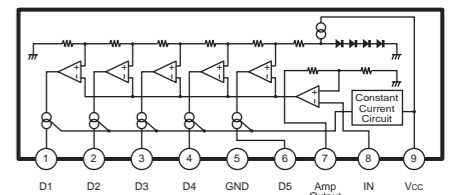

CIRCUIT BOARDS

MIX-1/3 Circuit Board

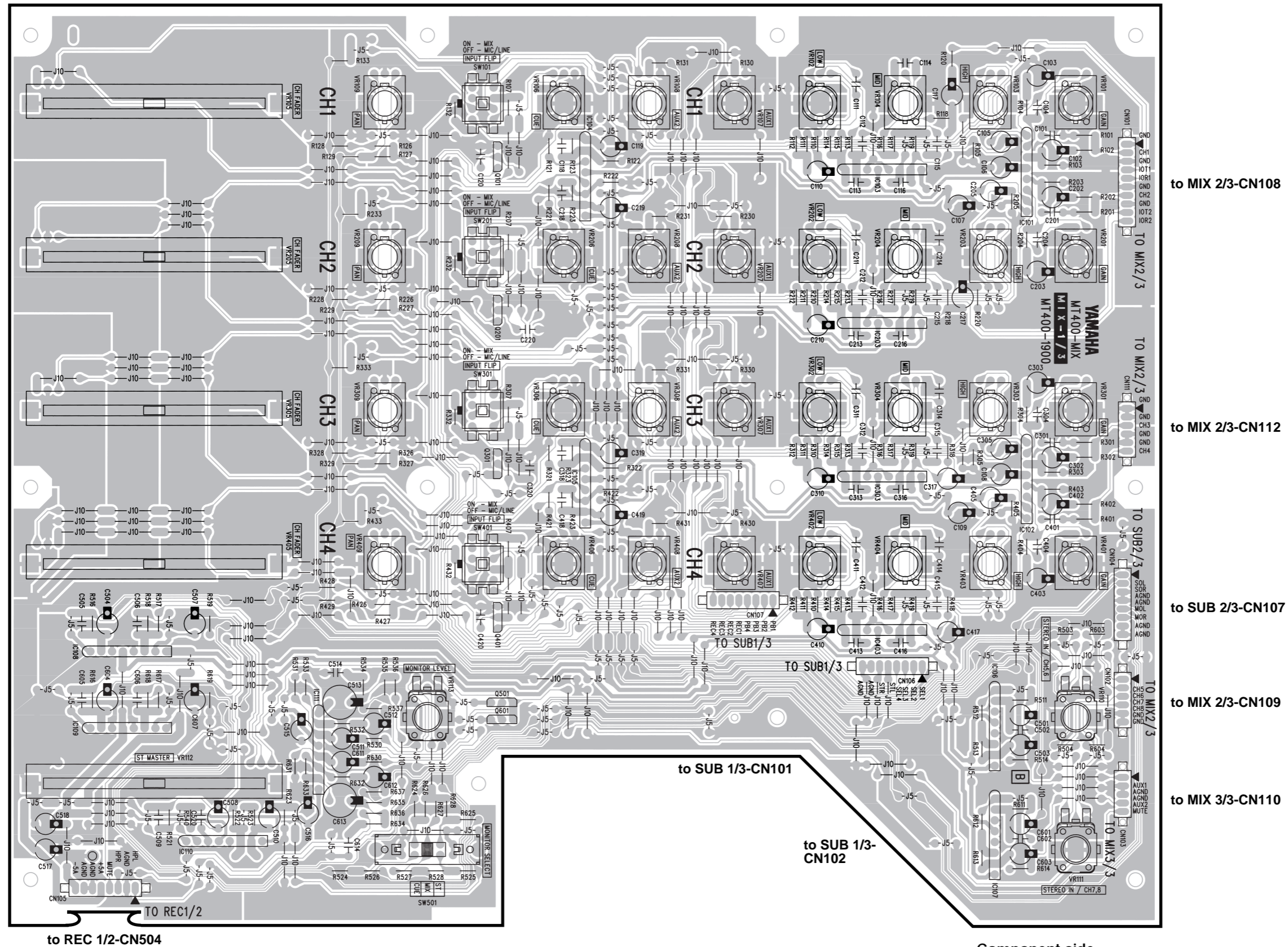

to REC 1/2-CN504

to SUB 1/3-CN101

to SUB 1/3-CN102

Component side

to MIX 2/3-CN108

to MIX 2/3-CN112

to SUB 2/3-CN107

to MIX 2/3-CN109

to MIX 3/3-CN110

• MIX-2/3 Circuit Board

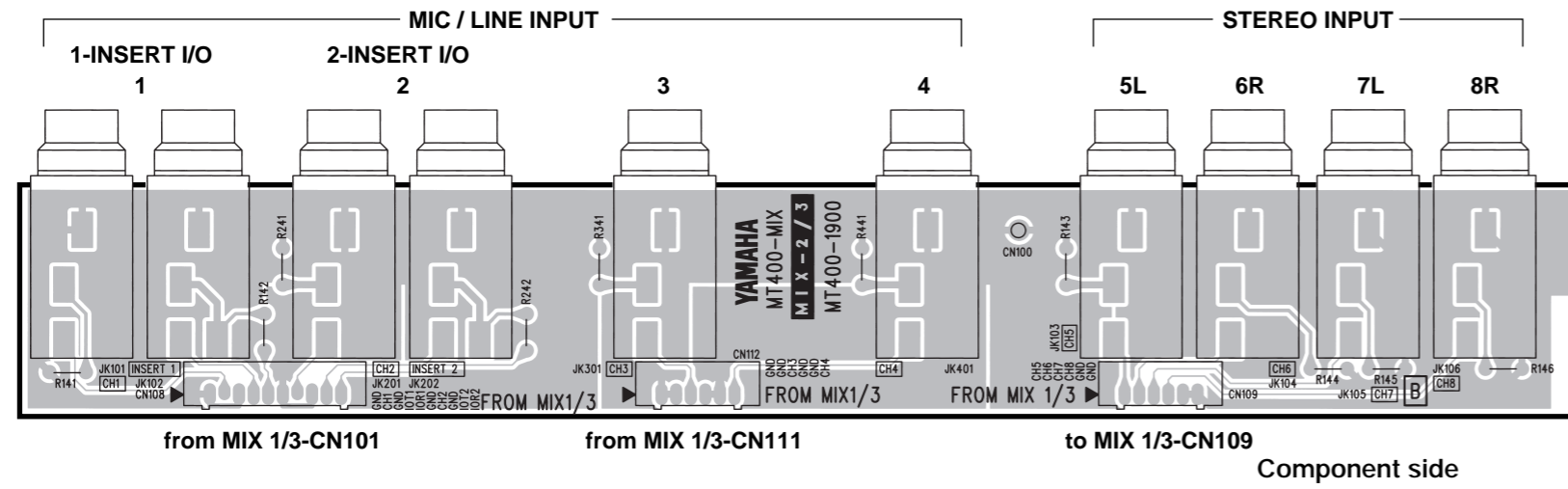

• SUB-1/3 Circuit Board

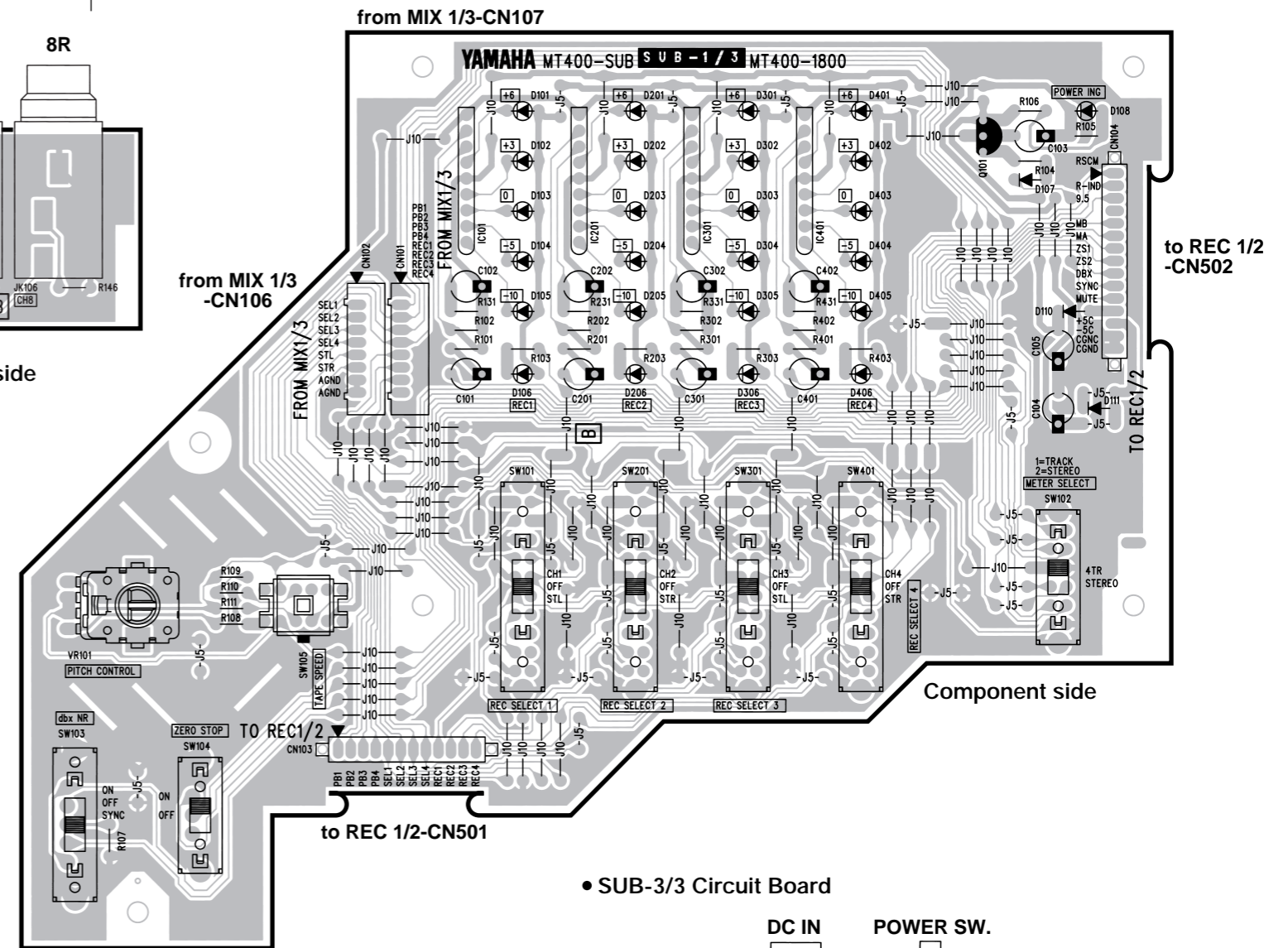

• MIX-3/3 Circuit Board

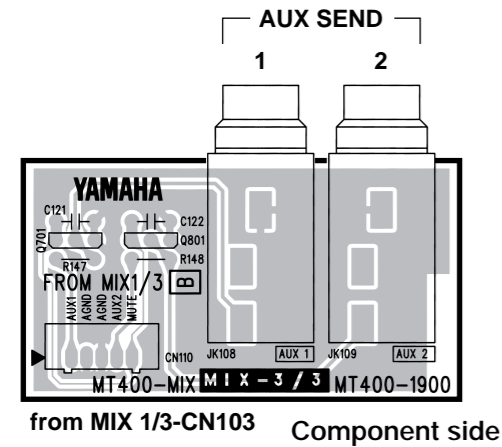

• SUB-2/3 Circuit Board

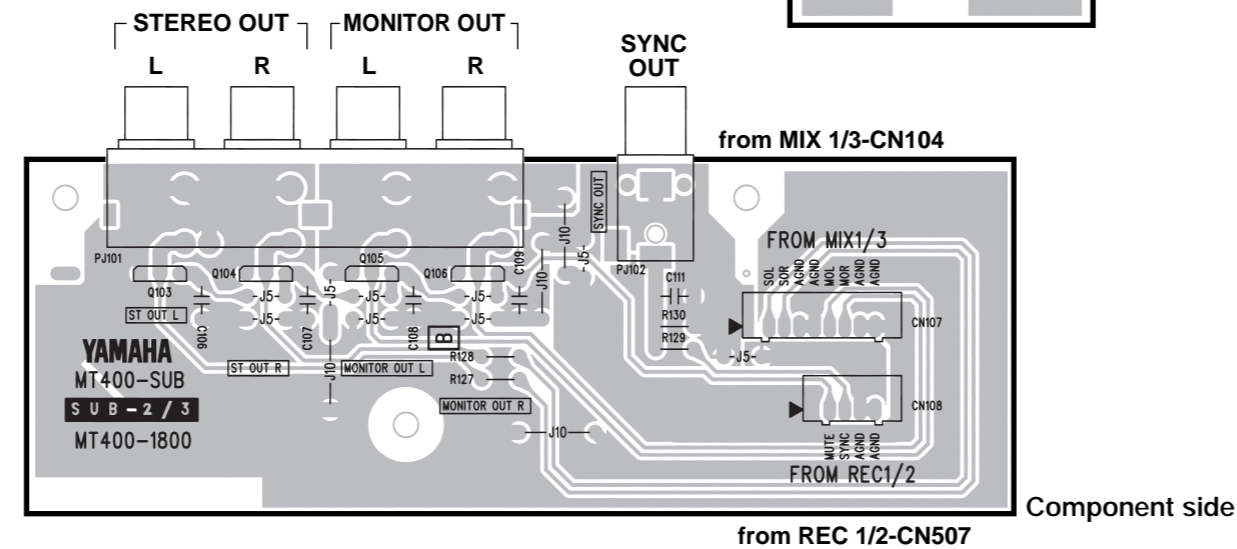

• SUB-3/3 Circuit Board

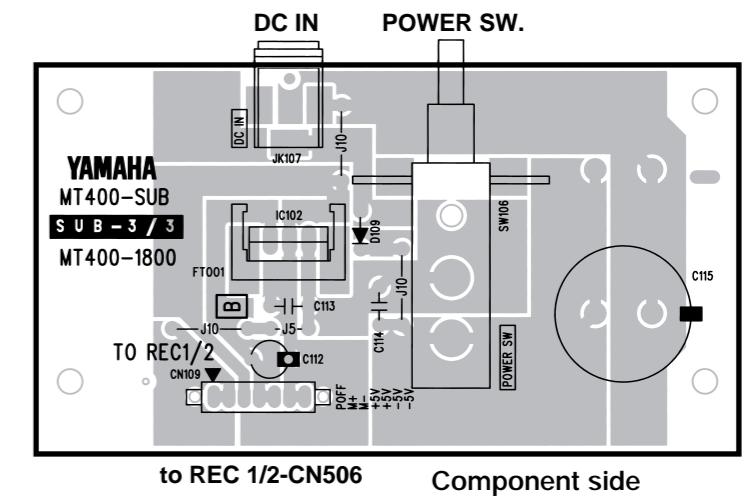

MIX : MT400-3400
SUB : MT400-3600

• REC-1/2 Circuit Board

to SUB 2/3-CN108

from SUB 1/3-CN103 from SUB 3/3-CN109

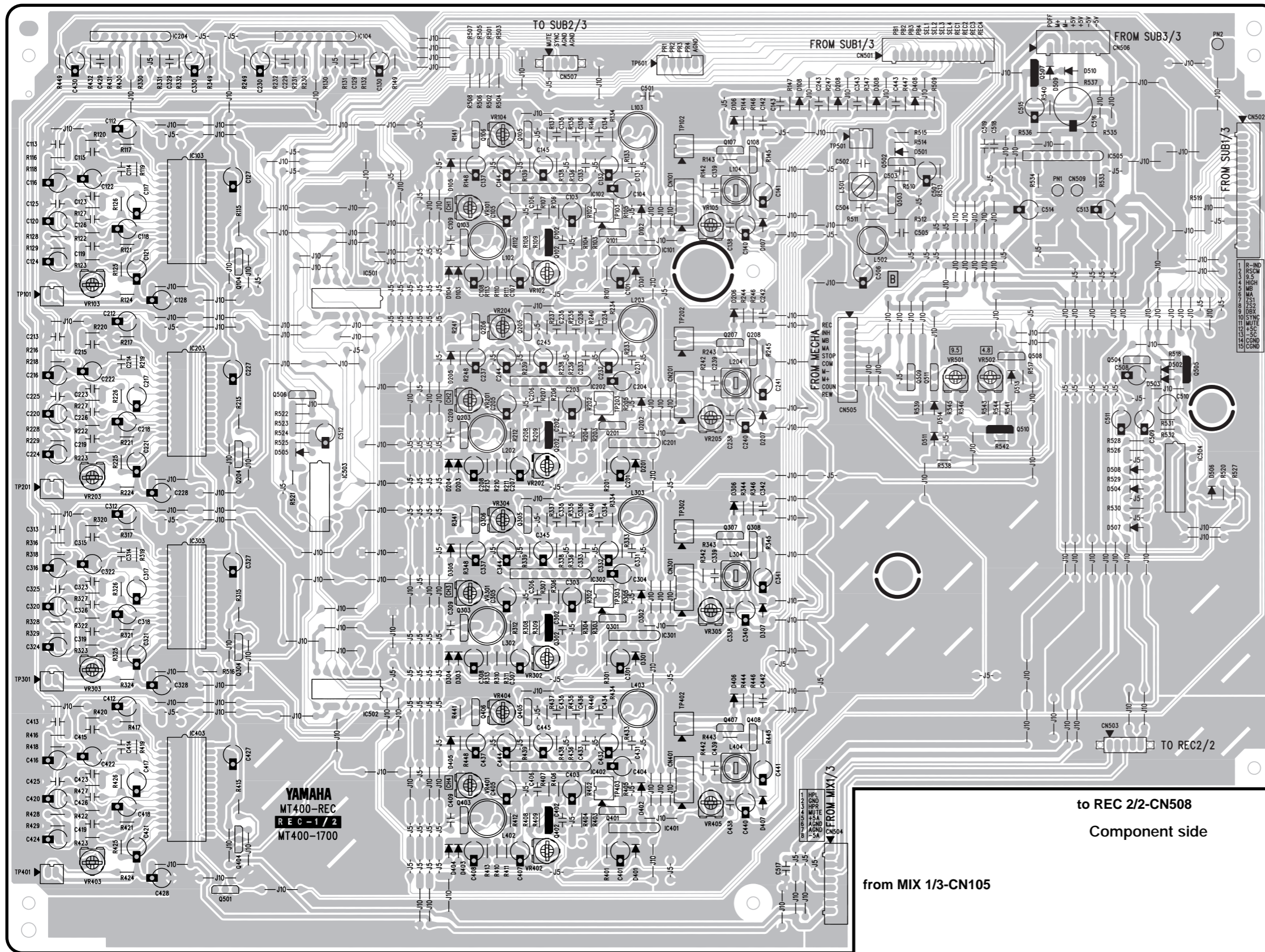

from SUB 1/3-CN104

• REC-2/2 Circuit Board

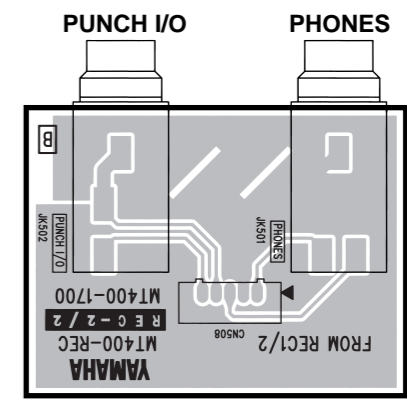

from REC 1/2-CN503
Component side

to REC 2/2-CN508
Component side

from MIX 1/3-CN105

INSPECTIONS

A. Preparation

1. Set Up

Set the level controls and switches as follows (unless otherwise specified).

1-1 CH 1, 2, 3, 4

GAIN VOLUME	LINE
EQ/ HIGH, MID, LOW VOLUME	CENTER
AUX 1, 2 VOLUME	MINIMUM
CUE VOLUME	MINIMUM
INPUT FLP SWITCH	MIC/ LINE
PAN VOLUME	CENTER
CH FADER	MINIMUM

1-2 CH 5/6, 7/8

LEVEL VOLUME	MINIMUM
--------------	---------

1-3 MASTER

MASTER FADER	MINIMUM
MONITOR LEVEL VOLUME	MINIMUM
MONITOR SELECT SWITCH	STEREO

1-4 RECORDER

REC SELECT SWITCH	OFF
dBx SWITCH	OFF

1-5 MECHANISM

PITCH CONTROL VOLUME	CENTER
TAPE SPEED SWITCH	9.5 cm/sec
ZERO STOP SWITCH	OFF

1-6 OTHER

METER SWITCH	4TR
--------------	-----

2. Input /Output

The handled signal level is assumed to be 0 dB = 0.775 V.

The input levels should be sine wave 1 kHz and -10 dBm, unless otherwise specified. Each output terminal should have the following load resistance.

STEREO OUT	10 kohm
MONITOR OUT	10 kohm
AUX OUT	10 kohm
SYNC OUT	10 kohm
PHONES (STEREO)	40 ohm

3. Position of CH / MASTER FADER

When the input levels for each channel are as specified, the CH FADER is positioned so that the ST/OUT (L/R) is at -10 dBm and the pointer is between 7 and 8.

4. Tapes

Alignment tape

TDK: AC514 (VU167300)
MAXELL: UD II U60

Test tape

A.BEX: TCC-121(TX911840) 315 Hz, -4 dB, 160 nWb / m
A.BEX: TCC-151(TX800460) 6.3 kHz
A.BEX: TCC111(TX911820) 3 kHz, -10 dB
A.BEX: TCW211(TX911550) 1.5 kHz, -4 dB

5. Test equipment required

- Low Frequency Oscillator
- AC voltmeter (level meter)
- DC voltmeter
- Oscilloscope
- Frequency Counter
- Mirror Cassette SONY: MC112C (TX911100)
- Torque meter SONY: TW-2231 (TX913450), etc.

6. Mechanical adjustment

6-1 Tape running

Check that a tape curl is not created when playing the mirror tape.
 When a tape curl occurs, adjust the height of the head after attaching a Y washer.

6-2 Torque check

Check that the torque of each measurement is within the standard listed below by using a torque meter.

Measurement	Mode	Standard
FF torque	FF	55 — 120 gcm
REW torque	REW	55 — 120 gcm
PLAY torque	PLAY	30 — 60 gcm
BT torque	PLAY	1 — 6 gcm

7. Electrical adjustments

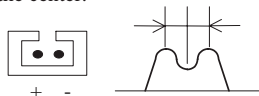
	Adjustments	Test Tape	Test Equipment	Mode	Condition	Test Point	Adjusting Point	Standard
1	dBx voltage	--	DC Voltmeter	--	--	TP101 TP201 TP301 TP401	VR103 VR203 VR303 VR403	18.4 +/- 0.2 mV 
2	Tape speed	TCW-211 TCC-111	Frequency counter	PLAY	9.5 cm check should have the priority	MONITOR OUT	VR501(9.5 cm) VR502(4.8 cm)	3000 +10 / -0 Hz
3	Azimuth and phase	TCC-151	AC Voltmeter Oscilloscope	PLAY	INPUT-FILP: TAPE FADER-3,4: MAX PAN-3: L, PAN-4: R	MONITOR OUT	Azimuth adjusting screw	Output: maximum Phase: in-phase
4	Playback level	TCC-121 TCC-151	AC Voltmeter Oscilloscope	PLAY	TAPE SPEED: 9.5 cm	TP601-1P TP601-2P TP601-3P TP601-4P TP601-1P TP601-2P TP601-3P TP601-4P	VR101 VR201 VR301 VR401 VR102 VR202 VR302 VR402	285 +/- 10 mV 135 mV (-15 +/- 3 dBm)
5	Bias frequency	--	Frequency counter	REC / PAUSE		TP501	L501	80 +/- 1 k Hz
6	Bias oscillation waveform	--	Oscilloscope	REC / PAUSE		TP102 TP202 TP302 TP402	L104 L204 L304 L404	Position the waveform recess at the center. 
7	Recording Bias	Alignment tape	AC Voltmeter Oscilloscope	REC	TAPE SPEED: 9.5 cm Input frequency: 1 k Hz 14 k Hz Output level: -30 dBm	CH1 CH2 CH3 CH4	VR105 VR205 VR305 VR405	Adjust the output level of 14 kHz to the same level as the output level of 1 k Hz.
8	Recording level	Alignment tape	AC Voltmeter Oscilloscope	REC PLAY	TAPE SPEED: 9.5 cm Input frequency: 1 k Hz Output level: 285 mV Record and play in the condition above.	CH1 CH2 CH3 CH4	VR104 VR204 VR304 VR404	285 +/- 10 mV

■ TROUBLESHOOTING

Symptom	Advice
MT400 cannot be turned on.	Make sure the AC adapter is connected to a suitable AC wall outlet securely and plugged into the DC 12V connector at the rear of the MT400.
	Make sure that a correct AC adapter is being used.
	Make sure that the MT400 POWER switch is set to the ON position.
Cannot listen to a connected music source.	Make sure that the [INPUT-FLIP] switches and the monitor select switch are set to the appropriate positions. When an [INPUT-FLIP] switch is set to "MIC/LINE (■)", raise the corresponding input channel fader and the STEREO fader, and set the monitor select switch to "STEREO" or "ST+CUE". When an [INPUT-FLIP] switch is set to "TAPE (■)", raise the corresponding channel CUE control and the STEREO fader, and set the monitor select switch to "STEREO" or "ST+CUE".
Cannot push in the REC button.	Make sure that tape's write-protect tabs are intact.
Cannot record.	Make sure that the [REC SELECT] switch is not set to "OFF".
	Make sure that you have assigned the signal that you want to record to the track. Use the CUE control to see if the signal is actually being sent to the track.
The level meters do not indicate signal levels.	Make sure that the [METER SELECT] switch is set correctly.
	Make sure that the recording track is in recording pause mode.
Recordings are noisy.	Use the dbx noise reduction.
	Make sure that the recording level is set correctly. Too low a signal level will cause the tape hiss to be more noticeable.
Recordings are distorted.	Make sure that the recording level is set correctly. Too high a signal level will cause distortion.
Recordings sound dull. Abnormal tape hiss. Wow and flutter. Fluctuating output level.	Clean the record-play head and other parts of the tape transport. Demagnetize the record-play head.
Recordings play back at a lower (or higher) pitch by one octave.	Use the same tape speed as for recording.
Cannot send a channel signal to the AUX SEND.	In addition to turning up the AUX control, you must also raise the channel fader. This is because the AUX SEND signal is source post-fader (i.e., after the fader).
MIDI sequencer does not synchronize to the MT400.	Make sure that the FSK/MIDI or SMPTE/MIDI converter is set to convert the recorded SYNC signal into MIDI Clock or MTC.
	Make sure that your MIDI sequencer is set to synchronize to an external MIDI Clock or MTC. Refer to the MIDI sequencer's user manual.

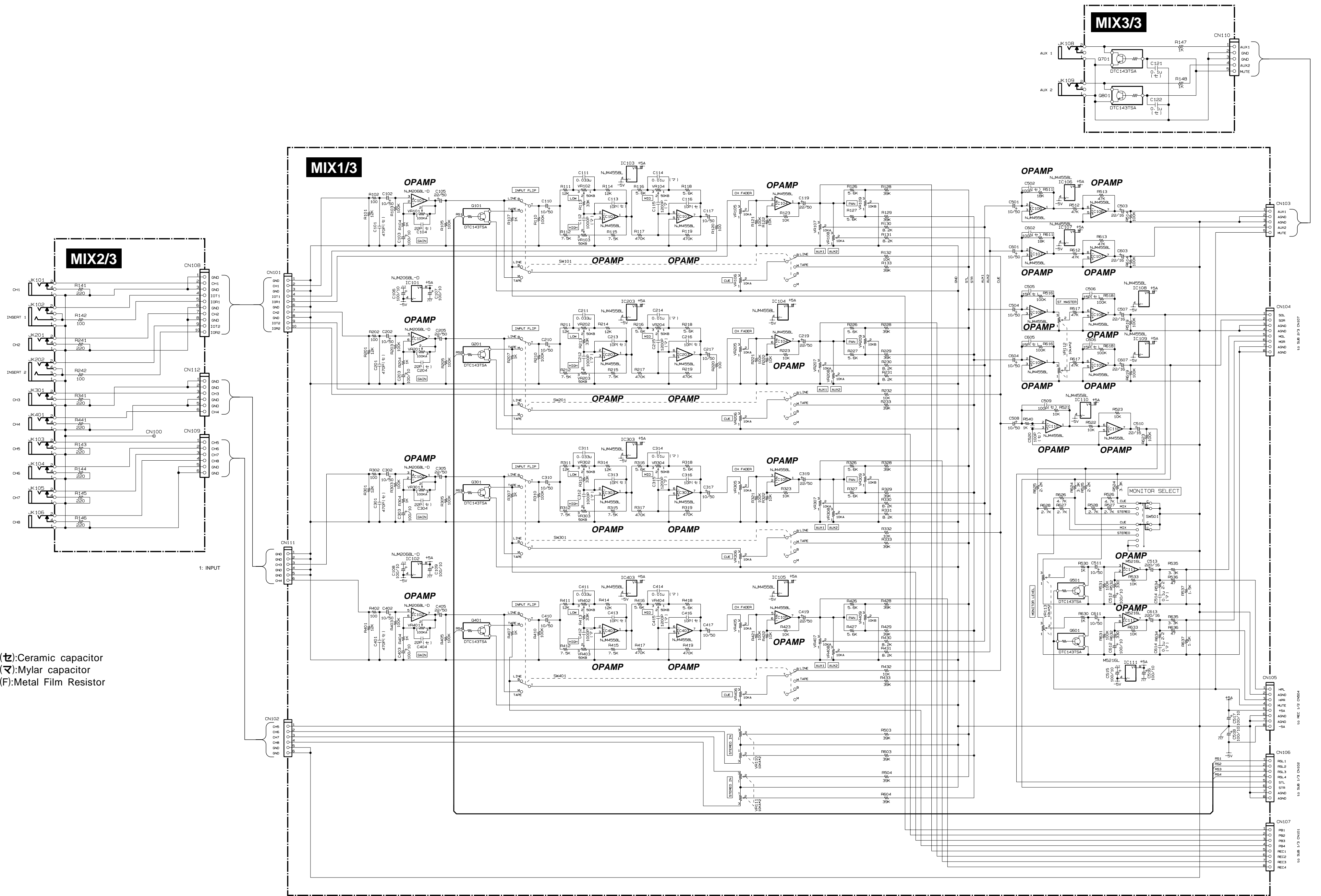

(t):Ceramic capacitor
 (M):Mylar capacitor
 (F):Metal Film Resistor

REC1/2 1/2

to MECHA HEAD

to MECHA HEAD

to MECHA HEAD

to MECHA HEAD

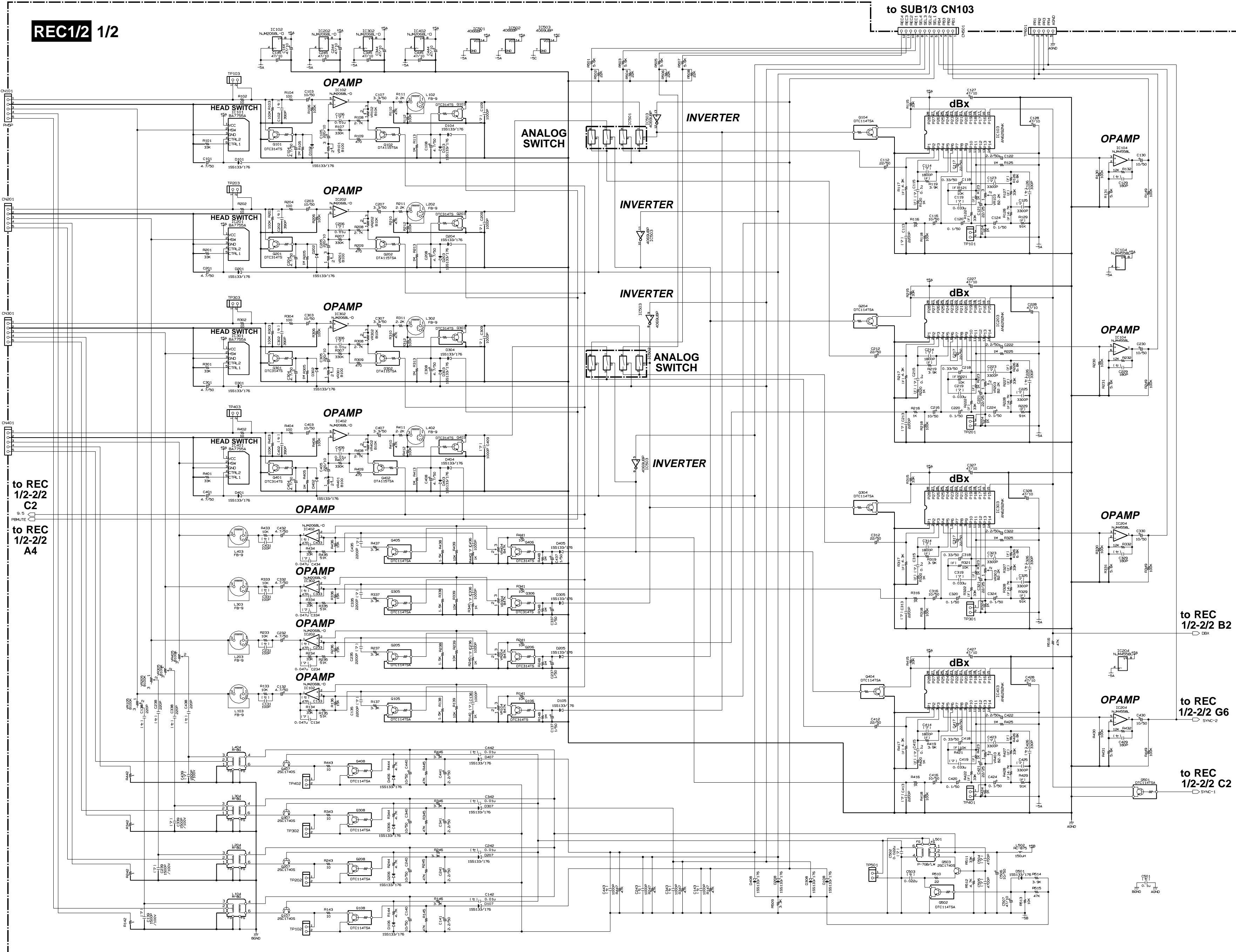

to REC 1/2-2/2 C2
 to REC 1/2-2/2 A4

to REC 1/2-2/2 B2
 DBX

to REC 1/2-2/2 G6
 SYNC-2

to REC 1/2-2/2 C2
 SYNC-1

MT400 CIRCUIT DIAGRAM 3/4(REC1/2-2/2,REC2/2)

MT400

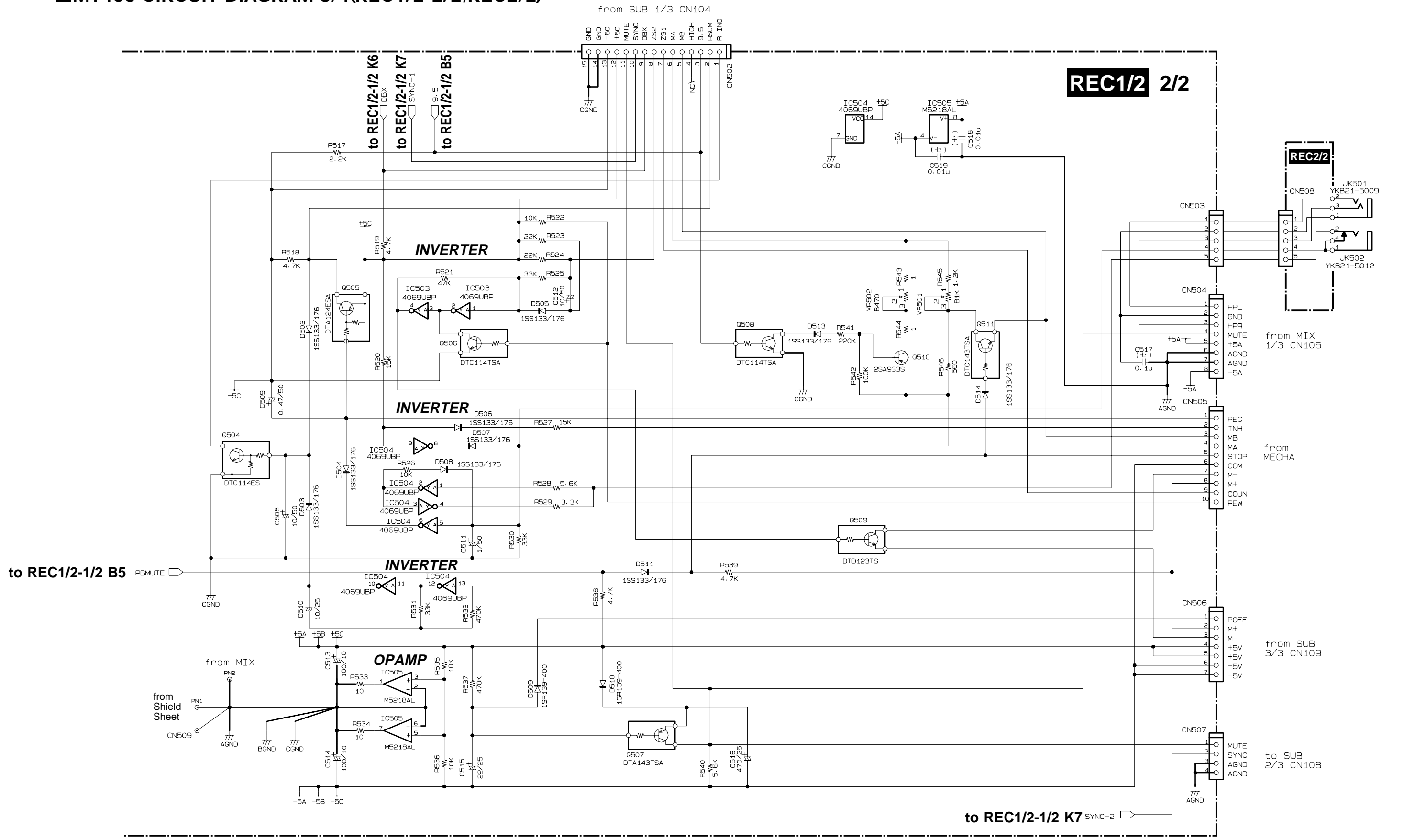

MT400

MT400-3200

MT400

MT400 CIRCUIT DIAGRAM 4/4(SUB-1/3,2/3,3/3)

MT400

SUB1/3

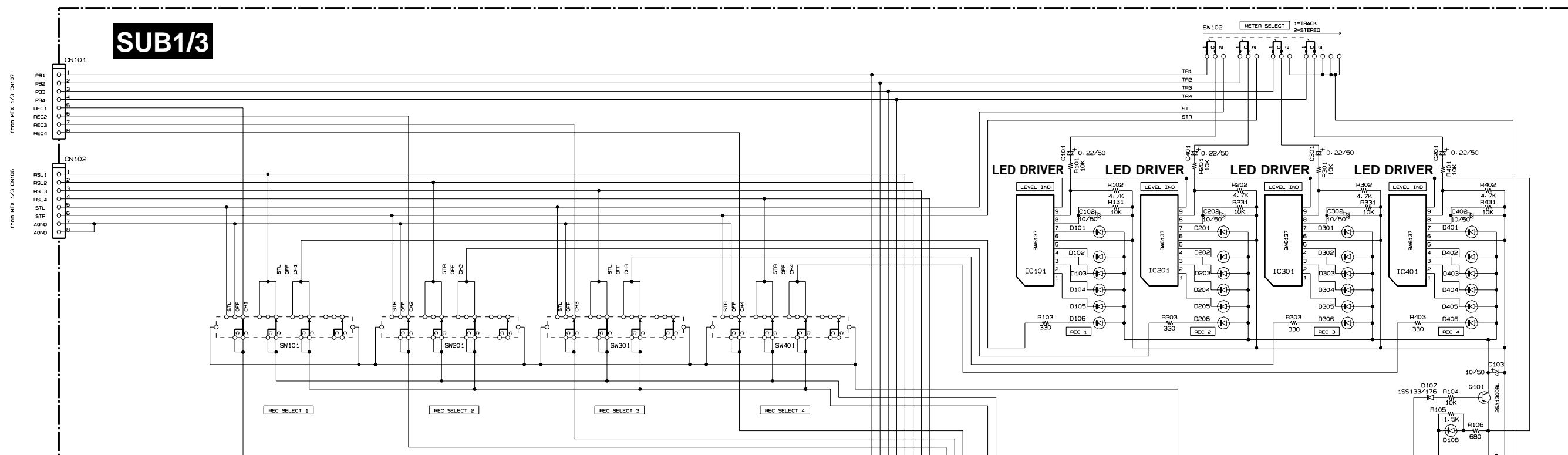

SUB2/3

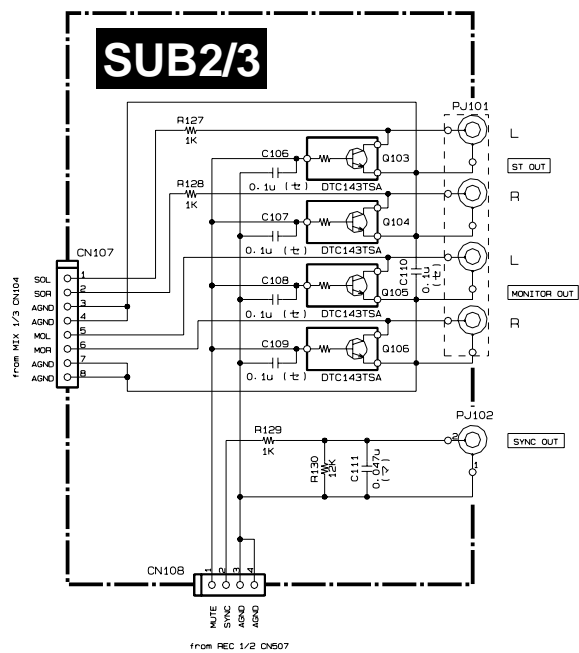

SUB3/3

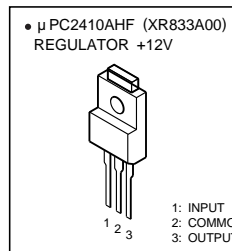
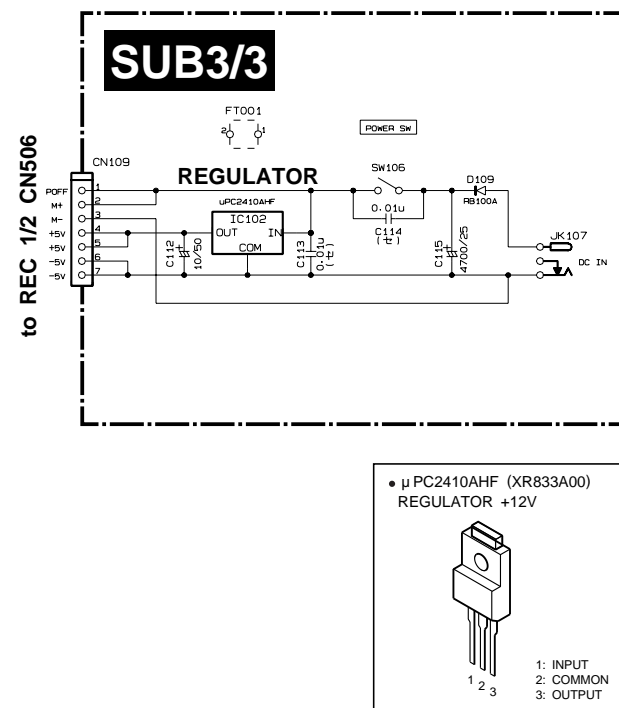

MT400

MT400

MT400-3300

MULTITRACK CASSETTE RECORDER

MT400

PARTS LIST

■ CONTENTS

OVERALL ASSEMBLY	2
CASSETTE MECHANISM ASSEMBLY	3
ELECTRICAL PARTS	5

Notes : DESTINATION ABBREVIATIONS

A : Australian model	J : Japanese model
B : British model	M : South African model
C : Canadian model	Q : South-east Asia model
D : German model	U : U.S.A. model
E : European model	V : General export model (110V)
F : French model	W : General export model (220V)
G : Belgian model	X : General export model
H : North European model	Y : Export model
I : Indonesian model	

- The numbers with "pc." or "pcs" in "Remarks" show quantities for each unit.
- The parts with "--" in "PART NO." are not available as spare parts.

OVERALL ASSEMBLY

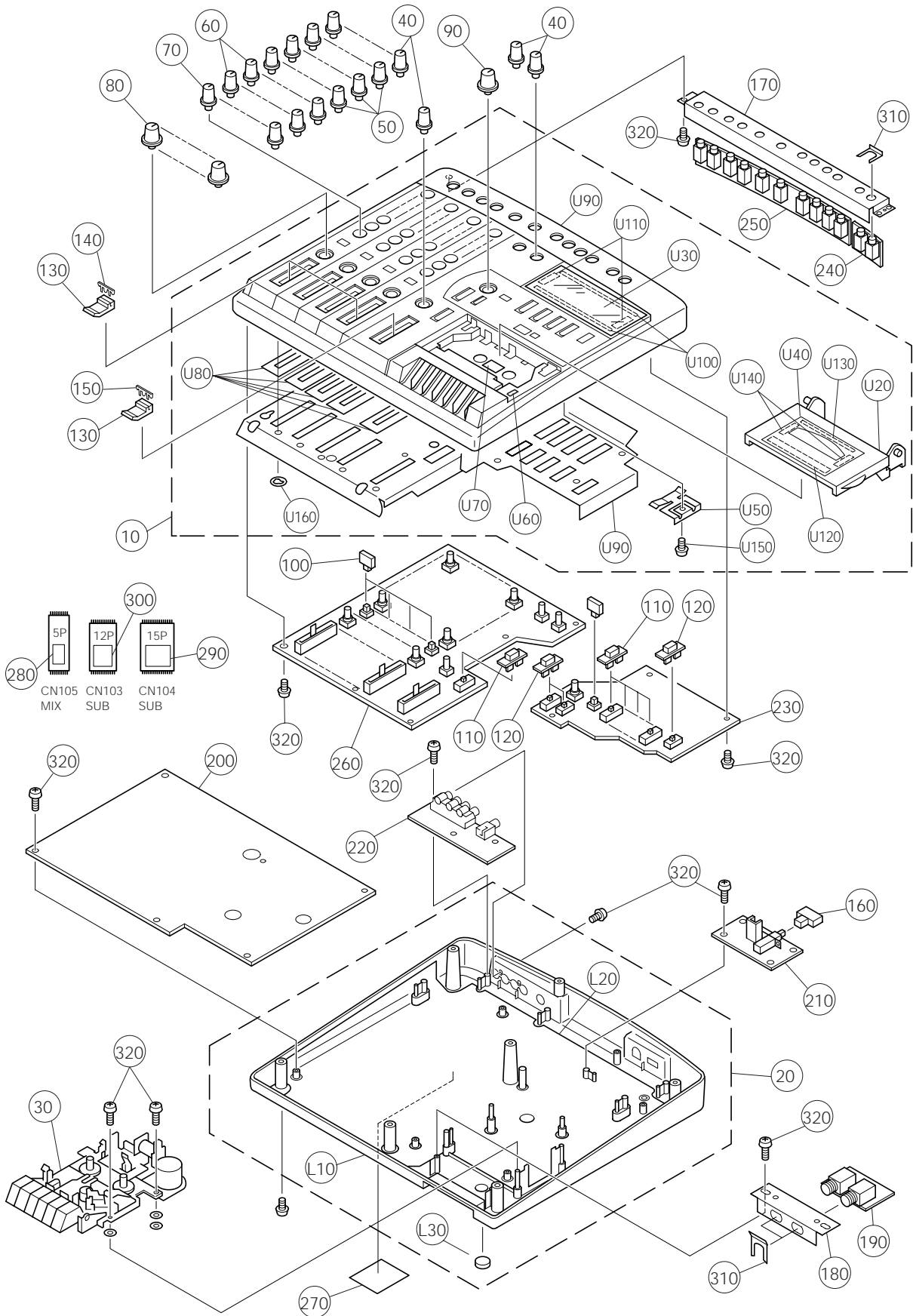

REF NO.	PART NO.	DESCRIPTION		REMARKS	QTY	RANK
*		OVERALL ASSEMBLY		MT400		
	--	Overall Assembly		MT400		
10	--	Upper Case Unit		MT400-1100		
20	--	Lower Case Unit		MT400-1200		
* 30	NX820240	Cassette Mechanism Unit		MT400-1300		
* 40	CX816200	Knob	D.GRAY/L.GRAY	MT400-009-D	7	
				GAIN,ST LEVEL,MONI LEVEL 7		
* 50	CX816210	Knob	D.GRAY/GREEN	MT400-009-B	12	
				EQ(HIGH,MID LOW)	12	
* 60	CX816220	Knob	D.GRAY/BLUE	MT400-009-A AUX1,2	8	
* 70	CX816230	Knob	L.GRAY/D.GRAY	MT400-009-C CUE	4	
* 80	CX816240	Knob	D.GRAY/RED	MT400-008-A PAN	4	
* 90	CX816250	Knob	D.GRAY/BLUE	MT400-008-B PITCH		
* 100	CX816260	Knob	D.GRAY/L.GRAY	MT400-010-A	5	
				INPUT FLIP,TAPE-SPEED	5	
* 110	CX816270	Knob	D.GRAY/RED	MT400-011-A	5	
				REC SELECT,MONITOR SELECT	5	
* 120	CX816280	Knob	D.GRAY/YELLOW	MT400-011-B dBx,	3	
				ZERO STOP,METER SELECT	3	
* 130	CX816290	Fader Knob	D.GRAY	MT400-012-A	5	
				CH Feder, STEREO Feder	5	
* 140	CX816300	Knob	L.GRAY	MT400-014-A CH Feder	4	
* 150	CX816310	Knob	RED	MT400-014-B STEREO Feder		
* 160	CX816320	Knob	BLACK	MT400-013 POWER ON/OFF		
* 170	AX818340	Rear Chassis		MT400-100		
* 180	AX818350	Holder, Jack	JACK	MT400-101		
* 190	NX820140	Circuit Board	REC 2/2			
* 200	NX820150	Circuit Board	REC 1/2			
* 210	NX820160	Circuit Board	SUB 3/3			
* 220	NX820170	Circuit Board	SUB 2/3			
* 230	NX820180	Circuit Board	SUB 1/3			
* 240	NX820190	Circuit Board	MIX 3/3			
* 250	NX820200	Circuit Board	MIX 2/3			
* 260	NX820210	Circuit Board	MIX 1/3			
270	--	Label		MT400-609		
* 280	BX801080	Dumper L	L	MT400-611		
* 290	BX801090	Dumper M	M	MT400-612		
* 300	BX801100	Dumper U	U	MT400-613		
* 310	AX818360	Angle Bracket	MET41-0191		14	
320	EP630660	Bind Head Tapping Screw-P	3X10 MFZN2BL		51	
	--	Upper Case Unit		MT400-1100		
* U10	AX818370	Upper Case		MT400-001		
* U20	BX801110	Cassette Lid		MT400-003		
* U30	BX801120	Window		MT400-600		
* U40	BX801130	Cassette Lid Window		MT400-601		
* U50	AX818380	Lid Spring		MT400-103		
* U60	CX816330	Lid Cushion		MT400-605	2	
* U70	BX801140	Reflector		MT400-608		
* U80	BX801150	Blind		MT400-602		
U90	NX820280	Shield Sheet		MT400-1400		
U100	--	Adhesive Tape	135X5 NITTO #500		2	
U110	--	Adhesive Tape	39X10 NITTO #500		2	
U120	--	Adhesive Tape	97X10 NITTO #500			
U130	--	Adhesive Tape	97X5 NITTO #500			
U140	--	Adhesive Tape	40X5 NITTO #500		2	
U150	EP630660	Bind P-Tite Screw	3X10 MFZN2BL			01
* U160	EX803860	CS Ring	M2		16	
	--	Lower Case Unit		MT400-1200		
* L10	AX818390	Lower Case		MT400-002		
L20	NX820290	Shield Sheet		MT400-1500		
* L30	CX816340	Foot		MT400-604		
		ACCESSORIES				
⚠	SX840020	AC Adapter		J 447-141-011		
⚠	SX840030	AC Adapter		U,C,V 477-143-011		
⚠	SX840040	AC Adapter		H,W 477-142-011		

* : New Parts

RANK : Japan only

CASSETTE MECHANISM ASSEMBLY

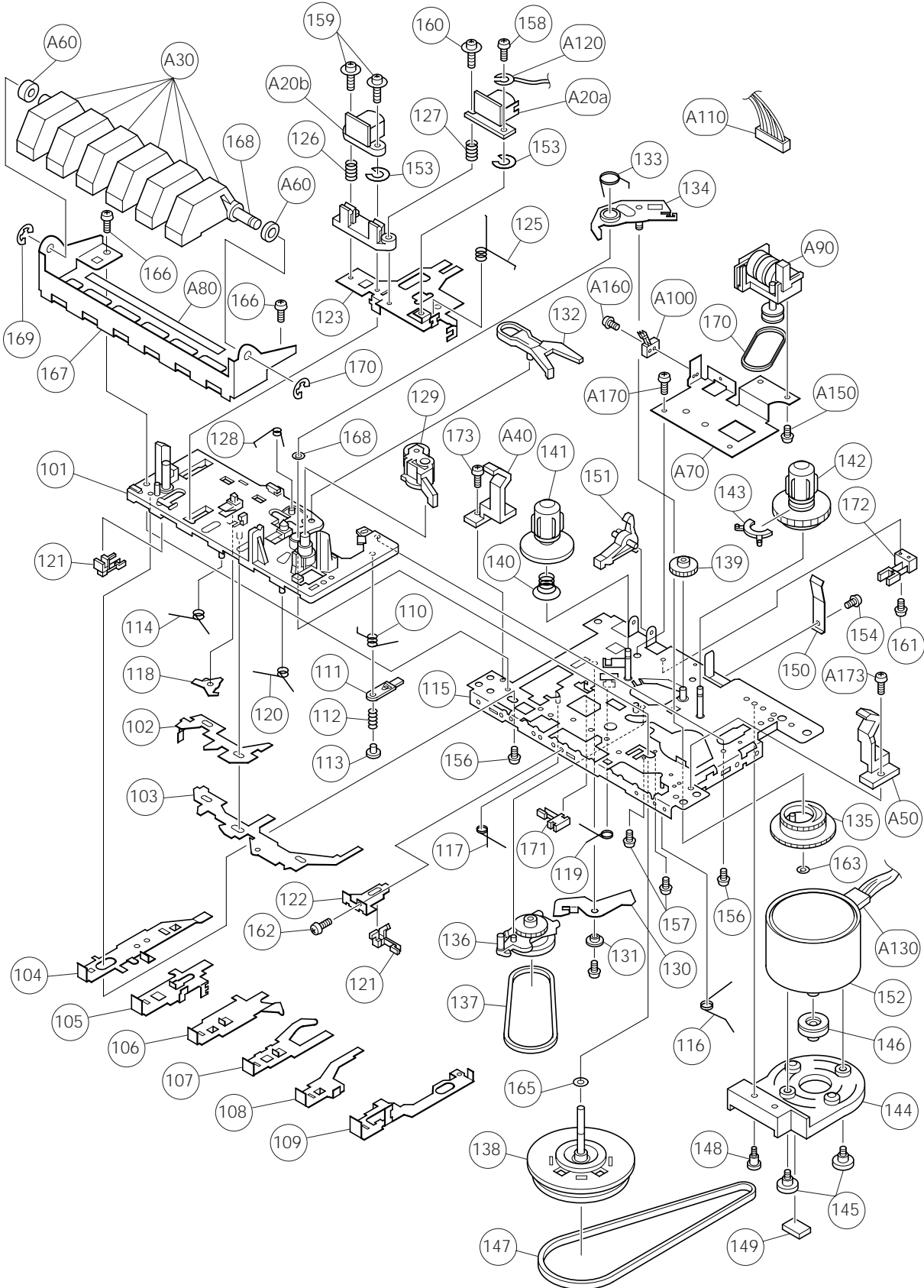

REF NO.	PART NO.	DESCRIPTION	REMARKS	QTY	RANK
		CASSETTE MECHANISM UNIT	MT400		
		Cassette Mechanism Unit	MT400-1300		
* A10	NX820240	Cassette Mech. Assembly	TN-21ZH-1797		
* A20	NX820230	Head Assembly	MT400-1600		
* A20a	NX820120	Record/Playback Head	N-LR44RS05		
* A20b	NX820130	Erase Head	N-E44A05		
* A30	CX816350	Knob	MT400-004 REC,PLAY,FF, REW,STOP,PAUSE	6	
* A40	BX801160	Cassette Guide L	MT400-005	6	
* A50	BX801170	Cassette Guide R	MT400-006		
* A60	BX801180	Spacer	MT400-007	2	
* A70	BX801190	Bracket	MT400-102		
* A80	--	Cushion	MT400-603		
* A90	NX820110	Counter	MK394S-008		
* A100	KX804800	Leaf Switch	1512		
A110	--	Connector Assembly	MT400-909		
A120	--	Lug Assembly	MT400-904		
A130	--	Connector Kit	MT400-913		
* A150	EX803870	Flat Tapping Screw	2.6X6 MFZN2Y	2	
* A160	EX803880	S.Tap-Tite Screw	2X8 MFZN2Y		
* A170	EX803890	S.Tap-Tite Screw	2X5 MFZN2Y	2	
* 101	NX820300	Cassette Mech.Assembly	TN-21ZH-1797		
* 102	NX815061	Base Assembly	1921 14 317		
* 103	AX815181	Switch Actuator	1921 14 40		
* 104	AX815041	Push Button Actuator	1921 14 08		
* 105	AX815151	Rec Button Lever	1921 14 22		
* 106	AX815161	Play Button Lever	1921 14 23		
* 107	AX815201	Rew Button Lever	1921 14 53		
* 108	AX818400	FF Button Lever	1921 14 25		
* 109	AX815171	Stop Button Lever	1921 14 26		
* 110	AX815221	Pause Button Lever	1921 14 61		
* 111	AX815071	P Control Spring	1921 14 13A		
* 112	AX815211	Pause Lever (E)	1921 14 55		
* 113	AX815061	Pause Lever Spring	1921 14 12		
* 114	AX815051	Pause Stopper	1921 14 11		
* 115	AX815081	Button Lever Spring (A)	1921 14 14		
* 116	NX815001	Chassis Assembly	1921 01 501		
* 117	AX815101	E Actuator Spring	1921 14 16		
* 118	AX815111	P.S.Lever Spring	1921 14 17		
* 119	AX815131	PR Stopper	1921 14 20		
* 120	AX815141	REC Button Lever Spring	1921 14 21		
* 121	AX815091	Button Lever Spring (B)	1921 14 15		
* 122	KX804121	Leaf Switch	6401 01 149	2	
* 123	AX815231	Switch Bracket	1921 15 03		
* 124	AX815001	Head Panel	1921 03 12		
* 125	AX808411	Head Base	1921 03 06		
* 126	AX814991	Panel P Spring	1921 03 09		
* 127	AX814911	EH Spring	1821 03 08		
* 128	AX808421	Azimuth Spring	1921 03 26		
* 129	AX815121	M Control Spring	1921 04 309		
* 130	NX815011	Pinch Roller Arm Assembly	1921 04 309		
* 131	AX814971	REC Arm	1921 02 01		
* 132	CX814351	P Arm Color	1921 14 37		
* 133	AX815241	Sensing Lever	1921 26 04A		
* 134	AX815251	Gear Plate Spring	1921 26 05		
* 135	NX815071	Gear Plate Assembly	1921 26 502		
* 136	CX814361	Cam Gear	1921 26 02		
* 137	NX820220	RF Clutch Assembly	1921 07 317		
* 138	CX816360	RF Belt	1921 07 11		
* 139	NX815051	Flywheel Assembly	1921 09 309		
* 140	CX814321	FF Gear	1821 10 70		
* 141	AX814941	Back Tension Spring	1821 10 99		
* 142	NX815031	Supply Reel Assembly	1921 05 304		
* 143	NX815021	Take Up Reel Assembly	1921 05 303		
* 144	IX807541	Sensor	1921 05 06		
* 145	AX815021	Motor Bracket	1921 12 07		
* 146	AX814961	Motor Color Screw	1921 12 02	2	
* 147	AX815031	Motor Pulley	1921 12 26		
* 148	CX816370	Main Belt	1921 09 27		

* : New Parts

RANK : Japan only

REF NO.	PART NO.	DESCRIPTION	REMARKS	QTY	RANK
* 148	AX815011	MB Screw	1921 12 03		
* 149	CX814311	Anti-Vibration Felt Mat	1800 10 47		
* 150	AX814921	Pack Spring	1821 10 03		
* 151	AX814931	Record Safety Lever	1821 10 69		
* 152	JX800721	Motor	6002 03 27		
* 153	CX814531	Y Washer	9W13 00 010	2	
* 154	EX803191	Bind Tapping Screw-C	M2X3		
* 155	EX803201	Bind Tapping Screw-C	M2X4		
* 156	EX803291	Bind Tapping Screw-P	M2X5		
* 157	EX803351	Screw	M2X4.5		
* 158	EX803181	Bind Head Screw	M2X3		
* 159	EX803301	Cap Screw	M2X8		
* 160	EX803321	Azimuth Screw	M2X7		
* 161	EX803211	Bind Head Screw-C	M2X5		
* 162	EX803311	Screw	M2X2.5		
* 163	CX814461	Washer	1.2X3.8X0.3		
* 164	CX814521	Washer	1.2X3.8X0.5		
* 165	CX814511	Washer	2X3.5X0.5		
* 166	CX816380	Washer	2.1X4X0.13		
* 167	EX803900	S Tapping Screw	M2X8		
* 168	AX814951	B Frame (H)	1821 31 02		
* 169	AX815261	Button Lever Shaft	1821 31 03		
* 170	AX815271	E Ring, Shaft	S3.2		
* 171	CX814471	Belt	9E01 00 321		
* 172	KX804131	Leaf Switch	1078 06 02A		
* 173	KX804141	Leaf Switch	6401 01 161		
* 174	EX803331	Bind Head Screw-C	6401 01 38		
			9P04 20 051		

* : New Parts

RANK : Japan only

ELECTRICAL PARTS

REF NO.	PART NO.	DESCRIPTION	REMARKS	QTY	RANK
		ELECTRICAL PARTS	MT400		
*	NX820190	Circuit Board	MIX 3/3		
*	NX820200	Circuit Board	MIX 2/3		
*	NX820210	Circuit Board	MIX 1/3		
*	NX820140	Circuit Board	REC 2/2		
*	NX820150	Circuit Board	REC 1/2		
*	NX820160	Circuit Board	SUB 3/3		
*	NX820170	Circuit Board	SUB 2/3		
*	NX820180	Circuit Board	SUB 1/3		
*	NX820190	Circuit Board	MIX 3/3		
*	NX820200	Circuit Board	MIX 2/3		
*	NX820210	Circuit Board	MIX 1/3		
	--	1P Contact Assembly	MT400-903		
	--	Jumper Wire	5mm		
	--	Jumper Wire	10mm		
C101	VF466900	Ceramic Capacitor	UP050 470P B K 50V		01
* C102	FX804270	Electrolytic Cap.	UVR1H 10 M 50V		
* C103	FX804290	Electrolytic Cap.	UVR1A 100 M 10V		
C104	VG276600	Ceramic Capacitor	UP050 22P SL J 50V		01
* C105	FX804280	Electrolytic Cap.	UVR1E 22 M 25V		
* C106	FX804290	Electrolytic Cap.	UVR1A 100 M 10V		
* -109	FX804290	Electrolytic Cap.	UVR1A 100 M 10V		
* C110	FX804270	Electrolytic Cap.	UVR1H 10 M 50V		
C111	UA654330	Mylar Capacitor	ECQB 0.033 J 50V		01
C112	UA653100	Mylar Capacitor	ECQB 1000P J 50V		03
C113	VF466600	Ceramic Capacitor	UP050 10P SL J 50V		01
C114	UA654100	Mylar Capacitor	ECQB 0.01 J 50V		01
C115	UA653120	Mylar Capacitor	ECQB 1200P J 50V		01
C116	VF466600	Ceramic Capacitor	UP050 10P SL J 50V		01
* C117	FX804270	Electrolytic Cap.	UVR1H 10 M 50V		
* C119	FX804280	Electrolytic Cap.	UVR1E 22 M 25V		
C121	VI307100	Ceramic Capacitor	UP050 0.1 F Z 50V		01
C122	VI307100	Ceramic Capacitor	UP050 0.1 F Z 50V		01
C201	VF466900	Ceramic Capacitor	UP050 470P B K 50V		01
* C202	FX804270	Electrolytic Cap.	UVR1H 10 M 50V		
* C203	FX804290	Electrolytic Cap.	UVR1A 100 M 10V		
C204	VG276600	Ceramic Capacitor	UP050 22P SL J 50V		01
* C205	FX804280	Electrolytic Cap.	UVR1E 22 M 25V		
* C210	FX804270	Electrolytic Cap.	UVR1H 10 M 50V		
C211	UA654330	Mylar Capacitor	ECQB 0.033 J 50V		01
C212	UA653100	Mylar Capacitor	ECQB 1000P J 50V		03
C213	VF466600	Ceramic Capacitor	UP050 10P SL J 50V		01
C214	UA654100	Mylar Capacitor	ECQB 0.01 J 50V		01
C215	UA653120	Mylar Capacitor	ECQB 1200P J 50V		01
* C217	FX804270	Electrolytic Cap.	UVR1H 10 M 50V		
* C219	FX804280	Electrolytic Cap.	UVR1E 22 M 25V		
C301	VF466900	Ceramic Capacitor	UP050 470P B K 50V		01
* C302	FX804270	Electrolytic Cap.	UVR1H 10 M 50V		
* C303	FX804290	Electrolytic Cap.	UVR1A 100 M 10V		
C304	VG276600	Ceramic Capacitor	UP050 22P SL J 50V		01
* C305	FX804280	Electrolytic Cap.	UVR1E 22 M 25V		
* C310	FX804270	Electrolytic Cap.	UVR1H 10 M 50V		
C311	UA654330	Mylar Capacitor	ECQB 0.033 J 50V		01
C312	UA653100	Mylar Capacitor	ECQB 1000P J 50V		03
C313	VF466600	Ceramic Capacitor	UP050 10P SL J 50V		01
C314	UA654100	Mylar Capacitor	ECQB 0.01 J 50V		01
C315	UA653120	Mylar Capacitor	ECQB 1200P J 50V		01
C316	VF466600	Ceramic Capacitor	UP050 10P SL J 50V		01
C316	VF466600	Ceramic Capacitor	UP050 10P SL J 50V		01
* C317	FX804270	Electrolytic Cap.	UVR1H 10 M 50V		
* C319	FX804280	Electrolytic Cap.	UVR1E 22 M 25V		
C401	VF466900	Ceramic Capacitor	UP050 470P B K 50V		01
* C402	FX804270	Electrolytic Cap.	UVR1H 10 M 50V		
* C403	FX804290	Electrolytic Cap.	UVR1A 100 M 10V		
C404	VG276600	Ceramic Capacitor	UP050 22P SL J 50V		01
* C405	FX804280	Electrolytic Cap.	UVR1E 22 M 25V		
* C410	FX804270	Electrolytic Cap.	UVR1H 10 M 50V		
C411	UA654330	Mylar Capacitor	ECQB 0.033 J 50V		01
C412	UA653100	Mylar Capacitor	ECQB 1000P J 50V		03

*: New Parts

RANK : Japan only

REF NO.	PART NO.	DESCRIPTION	REMARKS	QTY	RANK
C413	VF466600	Ceramic Capacitor	UP050 10P SL J 50V		01
C414	UA654100	Mylar Capacitor	ECQB 0.01 J 50V		01
C415	UA653120	Mylar Capacitor	ECQB 1200P J 50V		01
C416	VF466600	Ceramic Capacitor	UP050 10P SL J 50V		01
* C417	FX804270	Electrolytic Cap.	UVR1H 10 M 50V		
* C419	FX804280	Electrolytic Cap.	UVR1E 22 M 25V		
* C501	FX804270	Electrolytic Cap.	UVR1H 10 M 50V		
C502	VF466800	Ceramic Capacitor	UP050 100P B K 50V		01
* C503	FX804280	Electrolytic Cap.	UVR1E 22 M 25V		
* C504	FX804270	Electrolytic Cap.	UVR1H 10 M 50V		
C505	VG276200	Ceramic Capacitor	UP050 15P SL J 50V		01
C506	VG276200	Ceramic Capacitor	UP050 15P SL J 50V		01
* C507	FX804280	Electrolytic Cap.	UVR1E 22 M 25V		
* C508	FX804270	Electrolytic Cap.	UVR1H 10 M 50V		
C509	VF466800	Ceramic Capacitor	UP050 100P B K 50V		01
* C510	FX804280	Electrolytic Cap.	UVR1E 22 M 25V		
* C511	FX804270	Electrolytic Cap.	UVR1H 10 M 50V		
* C512	FX804290	Electrolytic Cap.	UVR1A 100 M 10V		
* C513	FX804300	Electrolytic Cap.	UVR1C 220 M 16V		
C514	UA655100	Mylar Capacitor	ECQB 0.1 J 50V		01
* C515	FX804290	Electrolytic Cap.	UVR1A 100 M 10V		
* C516	FX804290	Electrolytic Cap.	UVR1A 100 M 10V		
* -518	FX804290	Electrolytic Cap.	UVR1A 100 M 10V		
C520	VF466800	Ceramic Capacitor	UP050 100P B K 50V		01
* C601	FX804270	Electrolytic Cap.	UVR1H 10 M 50V		
C602	VF466800	Ceramic Capacitor	UP050 100P B K 50V		01
* C603	FX804280	Electrolytic Cap.	UVR1E 22 M 25V		
* C604	FX804270	Electrolytic Cap.	UVR1H 10 M 50V		
C605	VG276200	Ceramic Capacitor	UP050 15P SL J 50V		01
C606	VG276200	Ceramic Capacitor	UP050 15P SL J 50V		01
* C607	FX804280	Electrolytic Cap.	UVR1E 22 M 25V		
* C611	FX804270	Electrolytic Cap.	UVR1H 10 M 50V		
* C612	FX804290	Electrolytic Cap.	UVR1A 100 M 10V		
* C613	FX804300	Electrolytic Cap.	UVR1C 220 M 16V		
C614	UA655100	Mylar Capacitor	ECQB 0.1 J 50V		01
CN101	--	Cable Holder	51048-1000 10P		
CN101	--	Flat Cable	10P L70		
CN102	--	Cable Holder	51048-0600 6P		
CN102	--	Flat Cable	6P L70		
CN103	--	Cable Holder	51048-0500 5P		
CN103	--	Flat Cable	5P L90		
CN104	--	Cable Holder	51048-0800 8P		
CN104	--	Flat Cable	8P L130		
CN105	--	Cable Holder	51048-0800 8P		
CN105	--	Flat Cable	8P L300		
CN106	--	Cable Holder	51048-0800 8P		
CN106	--	Flat Cable	8P L100		
CN107	--	Cable Holder	51048-0800 8P		
CN107	--	Flat Cable	8P L150		
CN108	--	Wire Trap	52147-1010 10P		
CN109	--	Wire Trap	52147-0610 6P		
CN110	--	Wire Trap	52147-0510 5P		
CN111	--	Cable Holder	51048-0600 6P		
CN111	--	Flat Cable	6P L70		
CN112	--	Wire Trap	52147-0610 6P		
IC101	XM356A00	IC	NJM2068L-D	OP AMP	01
IC102	XM356A00	IC	NJM2068L-D	OP AMP	01
IC103	IX614610	IC	NJM4558L	OP AMP	03
-110	IX614610	IC	NJM4558L	OP AMP	03
IC111	XB419A00	IC	M5216L	OP AMP	03
IC203	IX614610	IC	NJM4558L	OP AMP	03
IC303	IX614610	IC	NJM4558L	OP AMP	03
IC403	IX614610	IC	NJM4558L	OP AMP	03
* JK101	LX804900	Phone Jack	YKB21-5012G	MIC/LINE INPUT 1	
* JK102	LX804910	Phone Jack	YKB21-5074G	Input 1 INSERT I/O	
* JK103	LX804900	Phone Jack	YKB21-5012G	STEREO INPUT 5L,6R,7L,8R	
* -106	LX804900	Phone Jack	YKB21-5012G		
* JK108	LX804900	Phone Jack	YKB21-5012G	AUX SEND 1	
* JK109	LX804900	Phone Jack	YKB21-5012G	AUX SEND 2	
* JK201	LX804900	Phone Jack	YKB21-5012G	MIC/LINE INPUT 2	

*: New Parts

RANK : Japan only

REF NO.	PART NO.	DESCRIPTION		REMARKS	QTY	RANK
* JK202	LX804910	Phone Jack	YKB21-5074G	Input 2 INSERT I/O MIC/LINE INPUT 3 MIC/LINE INPUT 4		
* JK301	LX804900	Phone Jack	YKB21-5012G			
* JK401	LX804900	Phone Jack	YKB21-5012G			
* Q101	IX808890	Digital Transistor	DTC143TSA-TP			
* Q201	IX808890	Digital Transistor	DTC143TSA-TP			
* Q301	IX808890	Digital Transistor	DTC143TSA-TP			
* Q401	IX808890	Digital Transistor	DTC143TSA-TP			
* Q501	IX808890	Digital Transistor	DTC143TSA-TP			
* Q601	IX808890	Digital Transistor	DTC143TSA-TP			
* Q701	IX808890	Digital Transistor	DTC143TSA-TP			
* Q801	IX808890	Digital Transistor	DTC143TSA-TP			
R101	HF857120	Carbon Resistor	RD16S 12K J 1/6W			01
R102	HF855100	Carbon Resistor	RD16S 100 J 1/6W			01
R103	HF858100	Carbon Resistor	RD16S 100K J 1/6W			01
R104	HF856100	Carbon Resistor	RD16S 1K J 1/6W			01
R105	HF858100	Carbon Resistor	RD16S 100K J 1/6W			01
R107	HF856100	Carbon Resistor	RD16S 1K J 1/6W			01
R110	HF858100	Carbon Resistor	RD16S 100K J 1/6W			01
R111	HF857120	Carbon Resistor	RD16S 12K J 1/6W			01
R112	HF856750	Carbon Resistor	RD16S 7.5K J 1/6W			01
R113	HF857330	Carbon Resistor	RD16S 33K J 1/6W			01
R114	HF857120	Carbon Resistor	RD16S 12K J 1/6W			01
R115	HF856750	Carbon Resistor	RD16S 7.5K J 1/6W			01
R116	HF856560	Carbon Resistor	RD16S 5.6K J 1/6W			01
R117	HF858470	Carbon Resistor	RD16S 470K J 1/6W			01
R118	HF856560	Carbon Resistor	RD16S 5.6K J 1/6W			01
R119	HF858470	Carbon Resistor	RD16S 470K J 1/6W			01
R120	HF855100	Carbon Resistor	RD16S 100 J 1/6W			01
R121	HF858100	Carbon Resistor	RD16S 100K J 1/6W			01
R122	HF857100	Carbon Resistor	RD16S 10K J 1/6W			01
R123	HF857100	Carbon Resistor	RD16S 10K J 1/6W			01
R126	HF856560	Carbon Resistor	RD16S 5.6K J 1/6W			01
R127	HF856560	Carbon Resistor	RD16S 5.6K J 1/6W			01
R128	HF857390	Carbon Resistor	RD16S 39K J 1/6W			01
R129	HF857390	Carbon Resistor	RD16S 39K J 1/6W			01
R130	HF856820	Carbon Resistor	RD16S 8.2K J 1/6W			01
R131	HF856820	Carbon Resistor	RD16S 8.2K J 1/6W			01
R132	HF857100	Carbon Resistor	RD16S 10K J 1/6W			01
R133	HF857390	Carbon Resistor	RD16S 39K J 1/6W			01
R141	HF855220	Carbon Resistor	RD16S 220 J 1/6W			01
R142	HF855100	Carbon Resistor	RD16S 100 J 1/6W			01
R143	HF855220	Carbon Resistor	RD16S 220 J 1/6W			01
-146	HF855220	Carbon Resistor	RD16S 220 J 1/6W			01
R147	HF856100	Carbon Resistor	RD16S 1K J 1/6W			01
R148	HF856100	Carbon Resistor	RD16S 1K J 1/6W			01
R201	HF857120	Carbon Resistor	RD16S 12K J 1/6W			01
R202	HF855100	Carbon Resistor	RD16S 100 J 1/6W			01
R203	HF858100	Carbon Resistor	RD16S 100K J 1/6W			01
R204	HF856100	Carbon Resistor	RD16S 1K J 1/6W			01
R205	HF858100	Carbon Resistor	RD16S 100K J 1/6W			01
R207	HF856100	Carbon Resistor	RD16S 1K J 1/6W			01
R210	HF858100	Carbon Resistor	RD16S 100K J 1/6W			01
R211	HF857120	Carbon Resistor	RD16S 12K J 1/6W			01
R212	HF856750	Carbon Resistor	RD16S 7.5K J 1/6W			01
R213	HF857330	Carbon Resistor	RD16S 33K J 1/6W			01
R214	HF857120	Carbon Resistor	RD16S 12K J 1/6W			01
R215	HF856750	Carbon Resistor	RD16S 7.5K J 1/6W			01
R216	HF856560	Carbon Resistor	RD16S 5.6K J 1/6W			01
R217	HF858470	Carbon Resistor	RD16S 470K J 1/6W			01
R218	HF856560	Carbon Resistor	RD16S 5.6K J 1/6W			01
R219	HF858470	Carbon Resistor	RD16S 470K J 1/6W			01
R220	HF855100	Carbon Resistor	RD16S 100 J 1/6W			01
R221	HF858100	Carbon Resistor	RD16S 100K J 1/6W			01
R222	HF857100	Carbon Resistor	RD16S 10K J 1/6W			01
R223	HF857100	Carbon Resistor	RD16S 10K J 1/6W			01
R226	HF856560	Carbon Resistor	RD16S 5.6K J 1/6W			01
R227	HF856560	Carbon Resistor	RD16S 5.6K J 1/6W			01
R228	HF857390	Carbon Resistor	RD16S 39K J 1/6W			01
R229	HF857390	Carbon Resistor	RD16S 39K J 1/6W			01
R230	HF856820	Carbon Resistor	RD16S 8.2K J 1/6W			01

*: New Parts

RANK : Japan only

REF NO.	PART NO.	DESCRIPTION	REMARKS	QTY	RANK
R231	HF856820	Carbon Resistor	RD16S 8.2K J 1/6W		01
R232	HF857100	Carbon Resistor	RD16S 10K J 1/6W		01
R233	HF857390	Carbon Resistor	RD16S 39K J 1/6W		01
R241	HF855220	Carbon Resistor	RD16S 220 J 1/6W		01
R242	HF855100	Carbon Resistor	RD16S 100 J 1/6W		01
R301	HF857120	Carbon Resistor	RD16S 12K J 1/6W		01
R302	HF855100	Carbon Resistor	RD16S 100 J 1/6W		01
R303	HF858100	Carbon Resistor	RD16S 100K J 1/6W		01
R304	HF856100	Carbon Resistor	RD16S 1K J 1/6W		01
R305	HF858100	Carbon Resistor	RD16S 100K J 1/6W		01
R307	HF856100	Carbon Resistor	RD16S 1K J 1/6W		01
R310	HF858100	Carbon Resistor	RD16S 100K J 1/6W		01
R311	HF857120	Carbon Resistor	RD16S 12K J 1/6W		01
R312	HF856750	Carbon Resistor	RD16S 7.5K J 1/6W		01
R313	HF857330	Carbon Resistor	RD16S 33K J 1/6W		01
R314	HF857120	Carbon Resistor	RD16S 12K J 1/6W		01
R315	HF856750	Carbon Resistor	RD16S 7.5K J 1/6W		01
R316	HF856560	Carbon Resistor	RD16S 5.6K J 1/6W		01
R317	HF858470	Carbon Resistor	RD16S 470K J 1/6W		01
R318	HF856560	Carbon Resistor	RD16S 5.6K J 1/6W		01
R319	HF858470	Carbon Resistor	RD16S 470K J 1/6W		01
R321	HF858100	Carbon Resistor	RD16S 100K J 1/6W		01
R322	HF857100	Carbon Resistor	RD16S 10K J 1/6W		01
R323	HF857100	Carbon Resistor	RD16S 10K J 1/6W		01
R326	HF856560	Carbon Resistor	RD16S 5.6K J 1/6W		01
R327	HF856560	Carbon Resistor	RD16S 5.6K J 1/6W		01
R328	HF857390	Carbon Resistor	RD16S 39K J 1/6W		01
R329	HF857390	Carbon Resistor	RD16S 39K J 1/6W		01
R330	HF856820	Carbon Resistor	RD16S 8.2K J 1/6W		01
R331	HF856820	Carbon Resistor	RD16S 8.2K J 1/6W		01
R332	HF857100	Carbon Resistor	RD16S 10K J 1/6W		01
R333	HF857390	Carbon Resistor	RD16S 39K J 1/6W		01
R341	HF855220	Carbon Resistor	RD16S 220 J 1/6W		01
R401	HF857120	Carbon Resistor	RD16S 12K J 1/6W		01
R402	HF855100	Carbon Resistor	RD16S 100 J 1/6W		01
R403	HF858100	Carbon Resistor	RD16S 100K J 1/6W		01
R404	HF856100	Carbon Resistor	RD16S 1K J 1/6W		01
R405	HF858100	Carbon Resistor	RD16S 100K J 1/6W		01
R407	HF856100	Carbon Resistor	RD16S 1K J 1/6W		01
R410	HF858100	Carbon Resistor	RD16S 100K J 1/6W		01
R411	HF857120	Carbon Resistor	RD16S 12K J 1/6W		01
R412	HF856750	Carbon Resistor	RD16S 7.5K J 1/6W		01
R413	HF857330	Carbon Resistor	RD16S 33K J 1/6W		01
R414	HF857120	Carbon Resistor	RD16S 12K J 1/6W		01
R415	HF856750	Carbon Resistor	RD16S 7.5K J 1/6W		01
R416	HF856560	Carbon Resistor	RD16S 5.6K J 1/6W		01
R417	HF858470	Carbon Resistor	RD16S 470K J 1/6W		01
R418	HF856560	Carbon Resistor	RD16S 5.6K J 1/6W		01
R419	HF858470	Carbon Resistor	RD16S 470K J 1/6W		01
R421	HF858100	Carbon Resistor	RD16S 100K J 1/6W		01
R422	HF857100	Carbon Resistor	RD16S 10K J 1/6W		01
R423	HF857100	Carbon Resistor	RD16S 10K J 1/6W		01
R426	HF856560	Carbon Resistor	RD16S 5.6K J 1/6W		01
R427	HF856560	Carbon Resistor	RD16S 5.6K J 1/6W		01
R428	HF857390	Carbon Resistor	RD16S 39K J 1/6W		01
R429	HF857390	Carbon Resistor	RD16S 39K J 1/6W		01
R430	HF856820	Carbon Resistor	RD16S 8.2K J 1/6W		01
R431	HF856820	Carbon Resistor	RD16S 8.2K J 1/6W		01
R432	HF857100	Carbon Resistor	RD16S 10K J 1/6W		01
R433	HF857390	Carbon Resistor	RD16S 39K J 1/6W		01
R441	HF855220	Carbon Resistor	RD16S 220 J 1/6W		01
R503	HF857390	Carbon Resistor	RD16S 39K J 1/6W		01
R504	HF857390	Carbon Resistor	RD16S 39K J 1/6W		01
R511	HF857180	Carbon Resistor	RD16S 18K J 1/6W		01
R512	HF857470	Carbon Resistor	RD16S 47K J 1/6W		01
R513	HF857470	Carbon Resistor	RD16S 47K J 1/6W		01
R514	HF858100	Carbon Resistor	RD16S 100K J 1/6W		01
R516	HF858100	Carbon Resistor	RD16S 100K J 1/6W		01
R517	HF857470	Carbon Resistor	RD16S 47K J 1/6W		01
R518	HF858100	Carbon Resistor	RD16S 100K J 1/6W		01

* : New Parts

RANK : Japan only

REF NO.	PART NO.	DESCRIPTION	REMARKS	QTY	RANK
R519	HF858100	Carbon Resistor	RD16S 100K J 1/6W		01
R521	HF857100	Carbon Resistor	RD16S 10K J 1/6W		01
-523	HF857100	Carbon Resistor	RD16S 10K J 1/6W		01
R524	HF856330	Carbon Resistor	RD16S 3.3K J 1/6W		01
R525	HF856150	Carbon Resistor	RD16S 2.2K J 1/6W		01
R526	HF856470	Carbon Resistor	RD16S 4.7K J 1/6W		01
R527	HF856270	Carbon Resistor	RD16S 2.7K J 1/6W		01
R528	HF856270	Carbon Resistor	RD16S 2.7K J 1/6W		01
R530	HF856100	Carbon Resistor	RD16S 1K J 1/6W		01
R531	HF858100	Carbon Resistor	RD16S 100K J 1/6W		01
R532	HF855330	Carbon Resistor	RD16S 330 J 1/6W		01
R533	HF857100	Carbon Resistor	RD16S 10K J 1/6W		01
R534	HF853220	Carbon Resistor	RD16S 2.2 J 1/6W		01
R535	HF856330	Carbon Resistor	RD16S 3.3K J 1/6W		01
R536	HF854470	Carbon Resistor	RD16S 47 J 1/6W		01
R537	HF856100	Carbon Resistor	RD16S 1.5K J 1/6W		01
R540	HF856100	Carbon Resistor	RD16S 1K J 1/6W		01
R603	HF857390	Carbon Resistor	RD16S 39K J 1/6W		01
R604	HF857390	Carbon Resistor	RD16S 39K J 1/6W		01
R611	HF857180	Carbon Resistor	RD16S 18K J 1/6W		01
R612	HF857470	Carbon Resistor	RD16S 47K J 1/6W		01
R613	HF857470	Carbon Resistor	RD16S 47K J 1/6W		01
R614	HF858100	Carbon Resistor	RD16S 100K J 1/6W		01
R616	HF858100	Carbon Resistor	RD16S 100K J 1/6W		01
R617	HF857470	Carbon Resistor	RD16S 47K J 1/6W		01
R618	HF858100	Carbon Resistor	RD16S 100K J 1/6W		01
R619	HF858100	Carbon Resistor	RD16S 100K J 1/6W		01
R623	HF858100	Carbon Resistor	RD16S 100K J 1/6W		01
R624	HF856330	Carbon Resistor	RD16S 3.3K J 1/6W		01
R625	HF856220	Carbon Resistor	RD16S 2.2K J 1/6W		01
R626	HF856470	Carbon Resistor	RD16S 4.7K J 1/6W		01
R627	HF856270	Carbon Resistor	RD16S 2.7K J 1/6W		01
R628	HF856270	Carbon Resistor	RD16S 2.7K J 1/6W		01
R630	HF856100	Carbon Resistor	RD16S 1K J 1/6W		01
R631	HF858100	Carbon Resistor	RD16S 100K J 1/6W		01
R632	HF855330	Carbon Resistor	RD16S 330 J 1/6W		01
R633	HF857100	Carbon Resistor	RD16S 10K J 1/6W		01
R634	HF853220	Carbon Resistor	RD16S 2.2 J 1/6W		01
R635	HF856330	Carbon Resistor	RD16S 3.3K J 1/6W		01
R636	HF854470	Carbon Resistor	RD16S 47 J 1/6W		01
R637	HF856150	Carbon Resistor	RD16S 1.5K J 1/6W		01
* SW101	KX804820	Push Switch	ESB68149	INPUT FLIP 1	
* SW201	KX804820	Push Switch	ESB68149	INPUT FLIP 2	
* SW301	KX804820	Push Switch	ESB68149	INPUT FLIP 3	
* SW401	KX804820	Push Switch	ESB68149	INPUT FLIP 4	
* SW501	KX804810	Slide Switch	SSSU023-P06S1	MONITOR PHONES SELECT	
* VR101	HX809240	Rotary Variable Resistor	EVUF2KFK4A15 A100K	GAIN CH1	
* VR102	HX809250	Rotary Variable Resistor	EVUF3KFK4B54 B50K	LOW CH1	
* VR103	HX809250	Rotary Variable Resistor	EVUF3KFK4B54 B50K	HIGH CH1	
* VR104	HX809250	Rotary Variable Resistor	EVUF3KFK4B54 B50K	MID CH1	
* VR105	HX809200	Slide Variable Resistor	NS-4502VP A10K	Fader CH1	
* VR106	HX809230	Rotary Variable Resistor	EVUF2KFK4A14 A10K	CUE CH1	
* VR107	HX809230	Rotary Variable Resistor	EVUF2KFK4A14 A10K	AUX1 CH1	
* VR108	HX809230	Rotary Variable Resistor	EVUF2KFK4A14 A10K	AUX2 CH1	
* VR109	HX809220	Rotary Variable Resistor	EVUF3KFK4B14 B10K	PAN CH1	
* VR110	HX809260	Rotary Variable Resistor	RK09K12C0 10KAX2	LEVEL 5L-6R	
* VR111	HX809260	Rotary Variable Resistor	RK09K12C0 10KAX2	LEVEL 7L-8R	
* VR112	HX809210	Slide Variable Resistor	NS-4502GVP A10K	STEREO	
* VR113	HX809260	Rotary Variable Resistor	RK09K12C0 10KAX2	MONITOR/PHONES LEVEL	
* VR201	HX809240	Rotary Variable Resistor	EVUF2KFK4A14 A10K	GAIN CH2	
* VR202	HX809250	Rotary Variable Resistor	EVUF3KFK4B54 B50K	LOW CH2	
* VR203	HX809250	Rotary Variable Resistor	EVUF3KFK4B54 B50K	HIGH CH2	
* VR204	HX809250	Rotary Variable Resistor	EVUF3KFK4B54 B50K	MID CH2	
* VR205	HX809200	Slide Variable Resistor	NS-4502VP A10K	Fader CH2	
* VR206	HX809230	Rotary Variable Resistor	EVUF2KFK4A14 A10K	CUE CH2	
* VR207	HX809230	Rotary Variable Resistor	EVUF2KFK4A14 A10K	AUX1 CH2	
* VR208	HX809230	Rotary Variable Resistor	EVUF2KFK4A14 A10K	AUX2 CH2	
* VR209	HX809220	Rotary Variable Resistor	EVUF3KFK4B14 B10K	PAN CH2	
* VR301	HX809240	Rotary Variable Resistor	EVUF2KFK4A14 A10K	GAIN CH3	
* VR302	HX809250	Rotary Variable Resistor	EVUF3KFK4B54 B50K	LOW CH3	

* : New Parts

RANK : Japan only

REF NO.	PART NO.	DESCRIPTION	部 品 名	REMARKS	QTY	RANK
* VR303	HX809250	Rotary Variable Resistor	EVUF3KFK4B54 B50K	HIGH CH3		
* VR304	HX809250	Rotary Variable Resistor	EVUF3KFK4B54 B50K	MID CH3		
* VR305	HX809200	Slide Variable Resistor	NS-4502VP A10K	Fader CH3		
* VR306	HX809230	Rotary Variable Resistor	EVUF2KFK4A14 A10K	CUE CH3		
* VR307	HX809230	Rotary Variable Resistor	EVUF2KFK4A14 A10K	AUX1 CH3		
* VR308	HX809230	Rotary Variable Resistor	EVUF2KFK4A14 A10K	AUX2 CH3		
* VR309	HX809220	Rotary Variable Resistor	EVUF3KFK4B14 B10K	PAN CH3		
* VR401	HX809240	Rotary Variable Resistor	EVUF2KFK4A14 A10K	GAIN CH4		
* VR402	HX809250	Rotary Variable Resistor	EVUF3KFK4B54 B50K	LOW CH4		
* VR403	HX809250	Rotary Variable Resistor	EVUF3KFK4B54 B50K	HIGH CH4		
* VR404	HX809250	Rotary Variable Resistor	EVUF3KFK4B54 B50K	MID CH4		
* VR405	HX809200	Slide Variable Resistor	NS-4502VP A10K	Fader CH4		
* VR406	HX809230	Rotary Variable Resistor	EVUF2KFK4A14 A10K	CUE CH4		
* VR407	HX809230	Rotary Variable Resistor	EVUF2KFK4A14 A10K	AUX1 CH4		
* VR408	HX809230	Rotary Variable Resistor	EVUF2KFK4A14 A10K	AUX2 CH4		
* VR409	HX809220	Rotary Variable Resistor	EVUF3KFK4B14 B10K	PAN CH4		
*	NX820140	Circuit Board	REC 2/2			
*	NX820150	Circuit Board	REC 1/2			
	--	Lug Assembly	400-914 MT05			
	--	Terminal Pin	RT-01T-1.0B			
	--	Jumper Wire	5mm			
	--	Jumper Wire	10mm			
* C101	FX804390	Electrolytic Cap.	UVR1H 4.7 M 50V			
C102	VG278700	Ceramic Capacitor	UP050 390P B K 50V			01
* C103	FX804270	Electrolytic Cap.	UVR1H 10 M 50V			
* C104	FX804390	Electrolytic Cap.	UVR1H 4.7 M 50V			
* C105	FX804410	Electrolytic Cap.	UVR1A 220 M 10V			
C106	UA654100	Mylar Capacitor	ECQB1H 0.01 J 50V			01
* C107	FX804380	Electrolytic Cap.	UVR1H 3.3 M 50V			
* C108	FX804390	Electrolytic Cap.	UVR1H 4.7 M 50V			
* C109	UA653100	Mylar Capacitor	ECQB1H 1000P J 50V			03
* C112	FX804280	Electrolytic Cap.	UVR1E 22 M 25V			
C113	UA653220	Mylar Capacitor	ECQB1H 2200P J 50V			01
C114	UA653180	Mylar Capacitor	ECQB1H 1800P J 50V			01
C115	UA655100	Mylar Capacitor	ECQB1H 0.1 J 50V			01
* C116	FX804270	Electrolytic Cap.	UVR1H 10 M 50V			
* C117	FX804280	Electrolytic Cap.	UVR1E 22 M 25V			
* C118	FX804340	Electrolytic Cap.	UVR1H 0.33 M 50V			
* C119	UA654330	Mylar Capacitor	ECQB1H 0.033 J 50V			01
* C120	FX804330	Electrolytic Cap.	UVR1H 0.1 M 50V			
* C121	FX804280	Electrolytic Cap.	UVR1E 22 M 25V			
* C122	FX804370	Electrolytic Cap.	UVR1H 2.2 M 50V			
* C123	UA653330	Mylar Capacitor	ECQB1H 3300P J 50V			01
* C124	FX804330	Electrolytic Cap.	UVR1H 0.1 M 50V			
C125	UA653330	Mylar Capacitor	ECQB1H 3300P J 50V			01
C126	VG278600	Ceramic Capacitor	UP050 330P B K 50V			01
* C127	FX804400	Electrolytic Cap.	UVR1A 47 M 10V			
* C128	FX804400	Electrolytic Cap.	UVR1A 47 M 10V			
C129	VG278300	Ceramic Capacitor	UP050 180P B K 50V			01
* C130	FX804270	Electrolytic Cap.	UVR1H 10 M 50V			
* C131	VF466800	Ceramic Capacitor	UP050 100P B K 50V			01
* C132	FX804390	Electrolytic Cap.	UVR1H 4.7 M 50V			
C133	VD840900	Ceramic Capacitor	UP050 47P SLJ 50V			01
C134	UA654470	Mylar Capacitor	ECQB1H 0.047 J 50V			01
C135	UA653220	Mylar Capacitor	ECQB1H 2200P J 50V			01
C136	UA653100	Mylar Capacitor	ECQB1H 1000P J 50V			03
* C137	FX804360	Electrolytic Cap.	UVR1H 1.0 M 50V			
C138	VG278400	Ceramic Capacitor	UP050 220P B K 50V			01
C139	UA653150	Mylar Capacitor	ECQB 1500P J 100V			01
* C140	FX804270	Electrolytic Cap.	UVR1H 10 M 50V			
* C141	FX804370	Electrolytic Cap.	UVR1H 2.2 M 50V			
* C142	FX804440	Ceramic Capacitor	EP050 0.01 Y N 16V			
* C143	FX804430	Ceramic Capacitor	UP050 1000P BK 50V			
* C144	FX804400	Electrolytic Cap.	UVR1A 47 M 10V			
* C145	FX804400	Electrolytic Cap.	UVR1A 47 M 10V			
* C201	FX804390	Electrolytic Cap.	UVR1H 4.7 M 50V			
C202	VG278700	Ceramic Capacitor	UP050 390P B K 50V			01
* C203	FX804270	Electrolytic Cap.	UVR1H 10 M 50V			
* C204	FX804390	Electrolytic Cap.	UVR1H 4.7 M 50V			

* : New Parts

RANK : Japan only

REF NO.	PART NO.	DESCRIPTION	部 品 名	REMARKS	QTY	RANK
* C205	FX804410	Electrolytic Cap.	UVR1A 220 M 10V			
C206	UA654100	Mylar Capacitor	ECQB1H 0.01 J 50V			01
* C207	FX804380	Electrolytic Cap.	UVR1H 3.3 M 50V			
* C208	FX804390	Electrolytic Cap.	UVR1H 4.7 M 50V			
C209	UA653100	Mylar Capacitor	ECQB1H 1000P J 50V			03
* C212	FX804280	Electrolytic Cap.	UVR1E 22 M 25V			
C213	UA653220	Mylar Capacitor	ECQB1H 2200P J 50V			01
C214	UA653180	Mylar Capacitor	ECQB1H 1800P J 50V			01
C215	UA655100	Mylar Capacitor	ECQB1H 0.1 J 50V			01
* C216	FX804270	Electrolytic Cap.	UVR1H 10 M 50V			
* C217	FX804280	Electrolytic Cap.	UVR1E 22 M 25V			
* C218	FX804340	Electrolytic Cap.	UVR1H 0.33 M 50V			
C219	UA654330	Mylar Capacitor	ECQB1H 0.033 J 50V			01
* C220	FX804330	Electrolytic Cap.	UVR1H 0.1 M 50V			
* C221	FX804280	Electrolytic Cap.	UVR1E 22 M 25V			
* C222	FX804370	Electrolytic Cap.	UVR1H 2.2 M 50V			
C223	UA653330	Mylar Capacitor	ECQB1H 3300P J 50V			01
* C224	FX804330	Electrolytic Cap.	UVR1H 0.1 M 50V			
C225	UA653330	Mylar Capacitor	ECQB1H 3300P J 50V			01
C226	VG278600	Ceramic Capacitor	UP050 330P B K 50V			01
* C227	FX804400	Electrolytic Cap.	UVR1A 47 M 10V			
* C228	FX804400	Electrolytic Cap.	UVR1A 47 M 10V			
C229	VG278300	Ceramic Capacitor	UP050 180P B K 50V			01
* C230	FX804270	Electrolytic Cap.	UVR1H 10 M 50V			
C231	VF466800	Ceramic Capacitor	UP050 100P B K 50V			01
* C232	FX804390	Electrolytic Cap.	UVR1H 4.7 M 50V			
C233	VD840900	Ceramic Capacitor	UP050 47P SLJ 50V			01
C234	UA654470	Mylar Capacitor	ECQB1H 0.047 J 50V			01
C235	UA653220	Mylar Capacitor	ECQB1H 2200P J 50V			01
C236	UA653100	Mylar Capacitor	ECQB1H 1000P J 50V			03
* C237	FX804360	Electrolytic Cap.	UVR1H 1.0 M 50V			
C238	VG278400	Ceramic Capacitor	UP050 220P B K 50V			01
C239	UA653150	Mylar Capacitor	ECQB 1500P J 100V			01
* C240	FX804270	Electrolytic Cap.	UVR1H 10 M 50V			
* C241	FX804370	Electrolytic Cap.	UVR1H 2.2 M 50V			
* C242	FX804440	Ceramic Capacitor	EP050 0.01 Y N 16V			
* C243	FX804430	Ceramic Capacitor	UP050 1000P BK 50V			
* C244	FX804400	Electrolytic Cap.	UVR1A 47 M 10V			
* C245	FX804400	Electrolytic Cap.	UVR1A 47 M 10V			
* C301	FX804390	Electrolytic Cap.	UVR1H 4.7 M 50V			
C302	VG278700	Ceramic Capacitor	UP050 390P B K 50V			01
* C303	FX804270	Electrolytic Cap.	UVR1H 10 M 50V			
* C304	FX804390	Electrolytic Cap.	UVR1H 4.7 M 50V			
* C305	FX804410	Electrolytic Cap.	UVR1A 220 M 10V			
C306	UA654100	Mylar Capacitor	ECQB1H 0.01 J 50V			01
* C307	FX804380	Electrolytic Cap.	UVR1H 3.3 M 50V			
* C308	FX804390	Electrolytic Cap.	UVR1H 4.7 M 50V			
C309	UA653100	Mylar Capacitor	ECQB1H 1000P J 50V			03
* C312	FX804280	Electrolytic Cap.	UVR1E 22 M 25V			
C313	UA653220	Mylar Capacitor	ECQB1H 2200P J 50V			01
C314	UA653180	Mylar Capacitor	ECQB1H 1800P J 50V			01
C315	UA655100	Mylar Capacitor	ECQB1H 0.1 J 50V			01
* C316	FX804270	Electrolytic Cap.	UVR1H 10 M 50V			
* C317	FX804280	Electrolytic Cap.	UVR1E 22 M 25V			
* C318	FX804340	Electrolytic Cap.	UVR1H 0.33 M 50V			
C319	UA654330	Mylar Capacitor	ECQB1H 0.033 J 50V			01
* C320	FX804330	Electrolytic Cap.	UVR1H 0.1 M 50V			
* C321	FX804280	Electrolytic Cap.	UVR1E 22 M 25V			
* C322	FX804370	Electrolytic Cap.	UVR1H 2.2 M 50V			
C323	UA653330	Mylar Capacitor	ECQB1H 3300P J 50V			01
* C324	FX804330	Electrolytic Cap.	UVR1H 0.1 M 50V			
C325	UA653330	Mylar Capacitor	ECQB1H 3300P J 50V			01
C326	VG278600	Ceramic Capacitor	UP050 330P B K 50V			01
* C327	FX804400	Electrolytic Cap.	UVR1A 47 M 10V			
* C328	FX804400	Electrolytic Cap.	UVR1A 47 M 10V			
C329	VG278300	Ceramic Capacitor	UP050 180P B K 50V			01
* C330	FX804270	Electrolytic Cap.	UVR1H 10 M 50V			
C331	VF466800	Ceramic Capacitor	UP050 100P B K 50V			01
* C332	FX804390	Electrolytic Cap.	UVR1H 4.7 M 50V			
C333	VD840900	Ceramic Capacitor	UP050 47P SLJ 50V			01

*: New Parts

RANK : Japan only

REF NO.	PART NO.	DESCRIPTION	REMARKS	QTY	RANK
C334	UA654470	Mylar Capacitor	ECQB1H 0.047 J 50V		01
C335	UA653220	Mylar Capacitor	ECQB1H 2200P J 50V		01
C336	UA653100	Mylar Capacitor	ECQB1H 1000P J 50V		03
* C337	FX804360	Electrolytic Cap.	UVR1H 1.0 M 50V		
C338	VG278400	Ceramic Capacitor	UP050 220P B K 50V		01
C339	UA653150	Mylar Capacitor	ECQB 1500P J 100V		01
* C340	FX804270	Electrolytic Cap.	UVR1H 10 M 50V		
* C341	FX804370	Electrolytic Cap.	UVR1H 2.2 M 50V		
* C342	FX804440	Ceramic Capacitor	EP050 0.01 Y N 16V		
* C343	FX804430	Ceramic Capacitor	UP050 1000P BK 50V		
* C344	FX804400	Electrolytic Cap.	UVR1A 47 M 10V		
* C345	FX804400	Electrolytic Cap.	UVR1A 47 M 10V		
* C401	FX804390	Electrolytic Cap.	UVR1H 4.7 M 50V		
C402	VG278700	Ceramic Capacitor	UP050 390P B K 50V		01
* C403	FX804270	Electrolytic Cap.	UVR1H 10 M 50V		
* C404	FX804390	Electrolytic Cap.	UVR1H 4.7 M 50V		
* C405	FX804410	Electrolytic Cap.	UVR1A 220 M 10V		
C406	UA654100	Mylar Capacitor	ECQB1H 0.01 J 50V		01
* C407	FX804380	Electrolytic Cap.	UVR1H 3.3 M 50V		
* C408	FX804390	Electrolytic Cap.	UVR1H 4.7 M 50V		
C409	UA653100	Mylar Capacitor	ECQB1H 1000P J 50V		03
* C412	FX804280	Electrolytic Cap.	UVR1E 22 M 25V		
C413	UA653220	Mylar Capacitor	ECQB1H 2200P J 50V		01
C414	UA653180	Mylar Capacitor	ECQB1H 1800P J 50V		01
C415	UA655100	Mylar Capacitor	ECQB1H 0.1 J 50V		01
* C416	FX804270	Electrolytic Cap.	UVR1H 10 M 50V		
* C417	FX804280	Electrolytic Cap.	UVR1E 22 M 25V		
* C418	FX804340	Electrolytic Cap.	UVR1H 0.33 M 50V		
C419	UA654330	Mylar Capacitor	ECQB1H 0.033 J 50V		01
* C420	FX804330	Electrolytic Cap.	UVR1H 0.1 M 50V		
* C421	FX804280	Electrolytic Cap.	UVR1E 22 M 25V		
* C422	FX804370	Electrolytic Cap.	UVR1H 2.2 M 50V		
C423	UA653330	Mylar Capacitor	ECQB1H 3300P J 50V		01
* C424	FX804330	Electrolytic Cap.	UVR1H 0.1 M 50V		
C425	UA653330	Mylar Capacitor	ECQB1H 3300P J 50V		01
C426	VG278600	Ceramic Capacitor	UP050 330P B K 50V		01
* C427	FX804400	Electrolytic Cap.	UVR1A 47 M 10V		
* C428	FX804400	Electrolytic Cap.	UVR1A 47 M 10V		
C429	VG278300	Ceramic Capacitor	UP050 180P B K 50V		01
* C430	FX804270	Electrolytic Cap.	UVR1H 10 M 50V		
C431	VF466800	Ceramic Capacitor	UP050 100P B K 50V		01
* C432	FX804390	Electrolytic Cap.	UVR1H 4.7 M 50V		
C433	VD840900	Ceramic Capacitor	UP050 47P SLJ 50V		01
C434	UA654470	Mylar Capacitor	ECQB1H 0.047 J 50V		01
C435	UA653220	Mylar Capacitor	ECQB1H 2200P J 50V		01
C436	UA653100	Mylar Capacitor	ECQB1H 1000P J 50V		03
* C437	FX804360	Electrolytic Cap.	UVR1H 1.0 M 50V		
C438	VG278400	Ceramic Capacitor	UP050 220P B K 50V		01
C439	UA653150	Mylar Capacitor	ECQB 1500P J 100V		01
* C440	FX804270	Electrolytic Cap.	UVR1H 10 M 50V		
* C441	FX804370	Electrolytic Cap.	UVR1H 2.2 M 50V		
* C442	FX804440	Ceramic Capacitor	EP050 0.01 Y N 16V		
* C443	FX804430	Ceramic Capacitor	UP050 1000P BK 50V		
* C444	FX804400	Electrolytic Cap.	UVR1A 47 M 10V		
* C445	FX804400	Electrolytic Cap.	UVR1A 47 M 10V		
C501	VI1307100	Ceramic Capacitor	UP050 0.1 F Z 50V		01
C502	UA654220	Mylar Capacitor	ECQB1H 0.022 J 50V		01
* C503	FX804450	Ceramic Capacitor	TP050 0.022 FZ 25V		
C504	UA653470	Mylar Capacitor	ECQB1H 4700P J 50V		01
C505	UA653470	Mylar Capacitor	ECQB1H 4700P J 50V		01
* C506	FX804270	Electrolytic Cap.	UVR1H 10 M 50V		
* C507	FX804400	Electrolytic Cap.	UVR1A 47 M 10V		
* C508	FX804270	Electrolytic Cap.	UVR1H 10 M 50V		
* C509	FX804350	Electrolytic Cap.	UVR1H 0.47 M 50V		
* C510	FX804420	Electrolytic Cap.	UVP1E 10 M 25V		
* C511	FX804360	Electrolytic Cap.	UVR1H 1.0 M 50V		
* C512	FX804270	Electrolytic Cap.	UVR1H 10 M 50V		
* C513	FX804290	Electrolytic Cap.	UVR1A 100 M 10V		
* C514	FX804290	Electrolytic Cap.	UVR1A 100 M 10V		
* C515	FX804280	Electrolytic Cap.	UVR1E 22 M 25V		

* : New Parts

RANK : Japan only

REF NO.	PART NO.	DESCRIPTION		REMARKS	QTY	RANK
* C516	FX804310	Electrolytic Cap.	UVR1E 470 M 25V			
C517	VI307100	Ceramic Capacitor	UP050 0.1 F Z 50V			01
* C518	AFX80432	OCeramic Capacitor	RPU07F 0.01 FZ 50			
* C519	FX804320	Ceramic Capacitor	RPU07F 0.01 FZ 50V			
CN101	--	Connector Base Post	5P PH-B5B			
CN102	--	Wire Trap	52147-1210			
CN201	--	Connector Base Post	5P PH-B5B			
CN301	--	Connector Base Post	5P PH-B5B			
CN401	--	Connector Base Post	5P PH-B5B			
CN502	--	Wire Trap	52147-1510			
CN503	--	Cable Holder	51048-0500			
CN503	--	Flat Cable	5P L70			
CN504	--	Wire Trap	52147-0810			
CN505	--	Connector Base Post	10P PH-B10B			
CN506	--	Wire Trap	52147-0710			
CN507	--	Cable Holder	51048-0400			
CN507	--	Flat Cable	4P L80			
CN508	--	Wire Trap	52147-0510			
D101	IF004600	Diode	1SS133(T-77)			01
-108	IF004600	Diode	1SS133(T-77)			01
D201	IF004600	Diode	1SS133(T-77)			01
-208	IF004600	Diode	1SS133(T-77)			01
D301	IF004600	Diode	1SS133(T-77)			01
-308	IF004600	Diode	1SS133(T-77)			01
D401	IF004600	Diode	1SS133(T-77)			01
-408	IF004600	Diode	1SS133(T-77)			01
D501	IF004600	Diode	1SS133(T-77)			01
-508	IF004600	Diode	1SS133(T-77)			01
D509	VU652800	Diode	1SR139-400(T-32)			01
D510	VU652800	Diode	1SR139-400(T-32)			01
D511	IF004600	Diode	1SS133(T-77)			01
D513	IF004600	Diode	1SS133(T-77)			01
D514	IF004600	Diode	1SS133(T-77)			01
IC101	XH519A00	IC	BA7755A	HEAD SWITCH		02
IC102	XM356A00	IC	NJM2068L-D	OP AMP		01
IC103	IX803220	IC	AN6292NK	dBx		09
IC104	IX614610	IC	NJM4558L	OP AMP		03
IC201	XH519A00	IC	BA7755A	HEAD SWITCH		02
IC202	XM356A00	IC	NJM2068L-D	OP AMP		01
IC203	IX803220	IC	AN6292NK	dBx		09
IC204	IX614610	IC	NJM4558L	OP AMP		03
IC301	XH519A00	IC	BA7755A	HEAD SWITCH		02
IC302	XM356A00	IC	NJM2068L-D	OP AMP		01
IC303	IX803220	IC	AN6292NK	dBx		09
IC401	XH519A00	IC	BA7755A	HEAD SWITCH		02
IC402	XM356A00	IC	NJM2068L-D	OP AMP		01
IC403	IX803220	IC	AN6292NK	dBx		09
IC501	IX631591	IC	TC4066BP	ANALOG SWITCH		06
IC502	IX631591	IC	TC4066BP	ANALOG SWITCH		06
IC503	IG001720	IC	TC4069UBP	INVERTER		03
IC504	IG001720	IC	TC4069UBP	INVERTER		03
IC505	XH471A00	IC	M5218AL	OP AMP		
* JK501	LX804920	Phone Jack	YKB21-5009G	PHONES		
* JK502	LX804900	Phone Jack	YKB21-5012G	PUNCH I/O		
* L102	VV911000	Bias Trap Coil				
* L103	VV911000	Bias Trap Coil				
* L104	VV910900	Bias Coil	SUB			
* L202	VV911000	Bias Trap Coil				
* L203	VV911000	Bias Trap Coil				
* L204	VV910900	Bias Coil	SUB			
* L302	VV911000	Bias Trap Coil				
* L303	VV911000	Bias Trap Coil				
* L304	VV910900	Bias Coil	SUB			
* L402	VV911000	Bias Trap Coil				
* L403	VV911000	Bias Trap Coil				
* L404	VV910900	Bias Coil	SUB			
* L501	VV910800	Bias Coil	MAIN			
* L502	VV911100	Chock Coil	RC-875-151K			
* Q101	IX808900	Digital Transistor	DTC314TS-TP			
* Q102	IX808840	Digital Transistor	DTA115TSA-TP			

*: New Parts

RANK : Japan only

REF NO.	PART NO.	DESCRIPTION	REMARKS	QTY	RANK
* Q103	IX808900	Digital Transistor	DTC314TS-TP		
* Q104	IX808870	Digital Transistor	DTC114TSA-TP		
* Q105	IX808870	Digital Transistor	DTC114TSA-TP		
* Q106	IX808900	Digital Transistor	DTC314TS-TP		
* Q107	IX808830	Transistor	2SC1740S-TP-R,S		
* Q108	IX808870	Digital Transistor	DTC114TSA-TP		
* Q201	IX808900	Digital Transistor	DTC314TS-TP		
* Q202	IX808840	Digital Transistor	DTA115TSA-TP		
* Q203	IX808900	Digital Transistor	DTC314TS-TP		
* Q204	IX808870	Digital Transistor	DTC114TSA-TP		
* Q205	IX808870	Digital Transistor	DTC114TSA-TP		
* Q206	IX808900	Digital Transistor	DTC314TS-TP		
* Q207	IX808830	Transistor	2SC1740S-TP-R,S		
* Q208	IX808870	Digital Transistor	DTC114TSA-TP		
* Q301	IX808900	Digital Transistor	DTC314TS-TP		
* Q302	IX808840	Digital Transistor	DTA115TSA-TP		
* Q303	IX808900	Digital Transistor	DTC314TS-TP		
* Q304	IX808870	Digital Transistor	DTC114TSA-TP		
* Q305	IX808870	Digital Transistor	DTC114TSA-TP		
* Q306	IX808900	Digital Transistor	DTC314TS-TP		
* Q307	IX808830	Transistor	2SC1740S-TP-R,S		
* Q308	IX808870	Digital Transistor	DTC114TSA-TP		
* Q401	IX808900	Digital Transistor	DTC314TS-TP		
* Q402	IX808840	Digital Transistor	DTA115TSA-TP		
* Q403	IX808900	Digital Transistor	DTC314TS-TP		
* Q404	IX808870	Digital Transistor	DTC114TSA-TP		
* Q405	IX808870	Digital Transistor	DTC114TSA-TP		
* Q406	IX808900	Digital Transistor	DTC314TS-TP		
* Q407	IX808830	Transistor	2SC1740S-TP-R,S		
* Q408	IX808870	Digital Transistor	DTC114TSA-TP		
* Q501	IX808870	Digital Transistor	DTC114TSA-TP		
* Q502	IX808870	Digital Transistor	DTC114TSA-TP		
* Q503	IX808830	Transistor	2SC1740S-TP-R,S		
* Q504	IX808880	Digital Transistor	DTC114ESA-TP		
* Q505	IX808850	Digital Transistor	DTA124ESA-TP		
* Q506	IX808870	Digital Transistor	DTC114TSA-TP		
* Q507	IX808860	Digital Transistor	DTA143TSA-TP		
* Q508	IX808870	Digital Transistor	DTC114TSA-TP		
* Q509	IX808910	Digital Transistor	DTD123TS-TP		
* Q510	IX808820	Transistor	2SA933AS-TP-R,S		
* Q511	IX808890	Digital Transistor	DTC143TSA-TP		
R101	HF857330	Carbon Resistor	RD16S 33K J 1/6W		01
R102	HF854100	Carbon Resistor	RD16S 10 J 1/6W		01
R103	HF858100	Carbon Resistor	RD16S 100K J 1/6W		01
R104	HF855100	Carbon Resistor	RD16S 100 J 1/6W		01
R105	HF859100	Carbon Resistor	RD16S 1M J 1/6W		01
R106	HF858100	Carbon Resistor	RD16S 100K J 1/6W		01
R107	HF858330	Carbon Resistor	RD16S 330K J 1/6W		01
R108	HF856270	Carbon Resistor	RD16S 2.7K J 1/6W		01
R109	HF855470	Carbon Resistor	RD16S 470 J 1/6W		01
R110	HF857470	Carbon Resistor	RD16S 47K J 1/6W		01
R111	HF856220	Carbon Resistor	RD16S 2.2K J 1/6W		01
R112	HF858100	Carbon Resistor	RD16S 100K J 1/6W		01
R113	HF859100	Carbon Resistor	RD16S 1M J 1/6W		01
R115	HF857330	Carbon Resistor	RD16S 33K J 1/6W		01
R116	HF856100	Carbon Resistor	RD16S 1K J 1/6W		01
* R117	HX809360	Metal Film Resistor	CRB20 4.3K F 1/5W		
R118	HF858100	Carbon Resistor	RD16S 100K J 1/6W		01
* R119	HX809350	Metal Film Resistor	CRB20 3.9K F 1/5W		
* R120	HX809340	Metal Film Resistor	CRB20 1K F 1/5W		
* R121	HX809390	Metal Film Resistor	CRB20 10K F 1/5W		
* R122	HX809400	Metal Film Resistor	CRB20 33K F 1/5W		
* R123	HX809340	Metal Film Resistor	CRB20 1K F 1/5W		
R124	HF856100	Carbon Resistor	RD16S 1K J 1/6W		01
R125	HF859100	Carbon Resistor	RD16S 1M J 1/6W		01
* R126	HX809380	Metal Film Resistor	CRB20 6.8K F 1/5W		
* R127	HX809400	Metal Film Resistor	CRB20 33K F 1/5W		
* R128	HX809370	Metal Film Resistor	CRB20 4.7K F 1/5W		
* R129	HX809410	Metal Film Resistor	CRB20 91K F 1/5W		
R130	HF858100	Carbon Resistor	RD16S 100K J 1/6W		01

* : New Parts

RANK : Japan only

REF NO.	PART NO.	DESCRIPTION	REMARKS	QTY	RANK
R131	HF856560	Carbon Resistor	RD16S 5.6K J 1/6W		01
R132	HF857120	Carbon Resistor	RD16S 12K J 1/6W		01
R133	HF857100	Carbon Resistor	RD16S 10K J 1/6W		01
R134	HF857330	Carbon Resistor	RD16S 33K J 1/6W		01
R135	HF857510	Carbon Resistor	RD16S 51K J 1/6W		01
R136	HF857150	Carbon Resistor	RD16S 15K J 1/6W		01
R137	HF856330	Carbon Resistor	RD16S 3.3K J 1/6W		01
R138	HF856150	Carbon Resistor	RD16S 1.5K J 1/6W		01
R139	HF857100	Carbon Resistor	RD16S 10K J 1/6W		01
R140	HF856100	Carbon Resistor	RD16S 1K J 1/6W		01
R141	HF857100	Carbon Resistor	RD16S 10K J 1/6W		01
R142	HF853100	Carbon Resistor	RD16S 1.0 J 1/6W		01
R143	HF854100	Carbon Resistor	RD16S 10 J 1/6W		01
R144	HF856470	Carbon Resistor	RD16S 4.7K J 1/6W		01
R145	HF857470	Carbon Resistor	RD16S 47K J 1/6W		01
R146	HF856330	Carbon Resistor	RD16S 3.3K J 1/6W		01
R147	HF857470	Carbon Resistor	RD16S 47K J 1/6W		01
R148	HF859100	Carbon Resistor	RD16S 1M J 1/6W		01
R149	HF858100	Carbon Resistor	RD16S 100K J 1/6W		01
R201	HF857330	Carbon Resistor	RD16S 33K J 1/6W		01
R202	HF854100	Carbon Resistor	RD16S 10 J 1/6W		01
R203	HF858100	Carbon Resistor	RD16S 100K J 1/6W		01
R204	HF855100	Carbon Resistor	RD16S 100 J 1/6W		01
R205	HF859100	Carbon Resistor	RD16S 1M J 1/6W		01
R206	HF858100	Carbon Resistor	RD16S 100K J 1/6W		01
R207	HF858330	Carbon Resistor	RD16S 330K J 1/6W		01
R208	HF856270	Carbon Resistor	RD16S 2.7K J 1/6W		01
R209	HF855470	Carbon Resistor	RD16S 470 J 1/6W		01
R210	HF857470	Carbon Resistor	RD16S 47K J 1/6W		01
R211	HF856220	Carbon Resistor	RD16S 2.2K J 1/6W		01
R212	HF858100	Carbon Resistor	RD16S 100K J 1/6W		01
R213	HF859100	Carbon Resistor	RD16S 1M J 1/6W		01
R216	HF856100	Carbon Resistor	RD16S 1K J 1/6W		01
* R217	HX809360	Metal Film Resistor	CRB20 4.3K F 1/5W		
R218	HF858100	Carbon Resistor	RD16S 100K J 1/6W		01
* R219	HX809350	Metal Film Resistor	CRB20 3.9K F 1/5W		
* R220	HX809340	Metal Film Resistor	CRB20 1K F 1/5W		
* R221	HX809390	Metal Film Resistor	CRB20 10K F 1/5W		
* R222	HX809400	Metal Film Resistor	CRB20 33K F 1/5W		
* R223	HX809340	Metal Film Resistor	CRB20 1K F 1/5W		
R224	HF856100	Carbon Resistor	RD16S 1K J 1/6W		01
R225	HF859100	Carbon Resistor	RD16S 1M J 1/6W		01
* R226	HX809380	Metal Film Resistor	CRB20 6.8K F 1/5W		
* R227	HX809400	Metal Film Resistor	CRB20 33K F 1/5W		
* R228	HX809370	Metal Film Resistor	CRB20 4.7K F 1/5W		
* R229	HX809410	Metal Film Resistor	CRB20 91K F 1/5W		
R230	HF858100	Carbon Resistor	RD16S 100K J 1/6W		01
R231	HF856560	Carbon Resistor	RD16S 5.6K J 1/6W		01
R232	HF857120	Carbon Resistor	RD16S 12K J 1/6W		01
R233	HF857100	Carbon Resistor	RD16S 10K J 1/6W		01
R234	HF857330	Carbon Resistor	RD16S 33K J 1/6W		01
R235	HF857510	Carbon Resistor	RD16S 51K J 1/6W		01
R236	HF857150	Carbon Resistor	RD16S 15K J 1/6W		01
R237	HF856330	Carbon Resistor	RD16S 3.3K J 1/6W		01
R238	HF856150	Carbon Resistor	RD16S 1.5K J 1/6W		01
R239	HF857100	Carbon Resistor	RD16S 10K J 1/6W		01
R240	HF856100	Carbon Resistor	RD16S 1K J 1/6W		01
R241	HF857100	Carbon Resistor	RD16S 10K J 1/6W		01
R242	HF853100	Carbon Resistor	RD16S 1.0 J 1/6W		01
R243	HF854100	Carbon Resistor	RD16S 10 J 1/6W		01
R244	HF856470	Carbon Resistor	RD16S 4.7K J 1/6W		01
R245	HF857470	Carbon Resistor	RD16S 47K J 1/6W		01
R246	HF856330	Carbon Resistor	RD16S 3.3K J 1/6W		01
R247	HF857470	Carbon Resistor	RD16S 47K J 1/6W		01
R248	HF859100	Carbon Resistor	RD16S 1M J 1/6W		01
R249	HF858100	Carbon Resistor	RD16S 100K J 1/6W		01
R251	HF857330	Carbon Resistor	RD16S 33K J 1/6W		01
R301	HF857330	Carbon Resistor	RD16S 33K J 1/6W		01
R302	HF854100	Carbon Resistor	RD16S 10 J 1/6W		01
R303	HF858100	Carbon Resistor	RD16S 100K J 1/6W		01

*: New Parts

RANK : Japan only

REF NO.	PART NO.	DESCRIPTION	REMARKS	QTY	RANK
R304	HF855100	Carbon Resistor	RD16S 100 J 1/6W		01
R305	HF859100	Carbon Resistor	RD16S 1M J 1/6W		01
R306	HF858100	Carbon Resistor	RD16S 100K J 1/6W		01
R307	HF858330	Carbon Resistor	RD16S 330K J 1/6W		01
R308	HF856270	Carbon Resistor	RD16S 2.7K J 1/6W		01
R309	HF855470	Carbon Resistor	RD16S 470 J 1/6W		01
R310	HF857470	Carbon Resistor	RD16S 47K J 1/6W		01
R311	HF856220	Carbon Resistor	RD16S 2.2K J 1/6W		01
R312	HF858100	Carbon Resistor	RD16S 100K J 1/6W		01
R313	HF859100	Carbon Resistor	RD16S 1M J 1/6W		01
R316	HF856100	Carbon Resistor	RD16S 1K J 1/6W		01
* R317	HX809360	Metal Film Resistor	CRB20 4.3K F 1/5W		
R318	HF858100	Carbon Resistor	RD16S 100K J 1/6W		01
* R319	HX809350	Metal Film Resistor	CRB20 3.9K F 1/5W		
* R320	HX809340	Metal Film Resistor	CRB20 1K F 1/5W		
* R321	HX809390	Metal Film Resistor	CRB20 10K F 1/5W		
* R322	HX809400	Metal Film Resistor	CRB20 33K F 1/5W		
* R323	HX809340	Metal Film Resistor	CRB20 1K F 1/5W		
R324	HF856100	Carbon Resistor	RD16S 1K J 1/6W		01
R325	HF859100	Carbon Resistor	RD16S 1M J 1/6W		01
* R326	HX809380	Metal Film Resistor	CRB20 6.8K F 1/5W		
* R327	HX809400	Metal Film Resistor	CRB20 33K F 1/5W		
* R328	HX809370	Metal Film Resistor	CRB20 4.7K F 1/5W		
* R329	HX809410	Metal Film Resistor	CRB20 91K F 1/5W		
R330	HF858100	Carbon Resistor	RD16S 100K J 1/6W		01
R331	HF856560	Carbon Resistor	RD16S 5.6K J 1/6W		01
R332	HF857120	Carbon Resistor	RD16S 12K J 1/6W		01
R333	HF857100	Carbon Resistor	RD16S 10K J 1/6W		01
R335	HF857510	Carbon Resistor	RD16S 51K J 1/6W		01
R336	HF857150	Carbon Resistor	RD16S 15K J 1/6W		01
R337	HF856330	Carbon Resistor	RD16S 3.3K J 1/6W		01
R338	HF856150	Carbon Resistor	RD16S 1.5K J 1/6W		01
R339	HF857100	Carbon Resistor	RD16S 10K J 1/6W		01
R340	HF856100	Carbon Resistor	RD16S 1K J 1/6W		01
R341	HF857100	Carbon Resistor	RD16S 10K J 1/6W		01
R342	HF853100	Carbon Resistor	RD16S 1.0 J 1/6W		01
R343	HF854100	Carbon Resistor	RD16S 10 J 1/6W		01
R344	HF856470	Carbon Resistor	RD16S 4.7K J 1/6W		01
R345	HF857470	Carbon Resistor	RD16S 47K J 1/6W		01
R346	HF856330	Carbon Resistor	RD16S 3.3K J 1/6W		01
R347	HF857470	Carbon Resistor	RD16S 47K J 1/6W		01
R348	HF859100	Carbon Resistor	RD16S 1M J 1/6W		01
R349	HF858100	Carbon Resistor	RD16S 100K J 1/6W		01
R401	HF857330	Carbon Resistor	RD16S 33K J 1/6W		01
R402	HF854100	Carbon Resistor	RD16S 10 J 1/6W		01
R403	HF858100	Carbon Resistor	RD16S 100K J 1/6W		01
R404	HF855100	Carbon Resistor	RD16S 100 J 1/6W		01
R405	HF859100	Carbon Resistor	RD16S 1M J 1/6W		01
R406	HF858100	Carbon Resistor	RD16S 100K J 1/6W		01
R407	HF858330	Carbon Resistor	RD16S 330K J 1/6W		01
R408	HF856270	Carbon Resistor	RD16S 2.7K J 1/6W		01
R409	HF855470	Carbon Resistor	RD16S 470 J 1/6W		01
R410	HF857470	Carbon Resistor	RD16S 47K J 1/6W		01
R411	HF856220	Carbon Resistor	RD16S 2.2K J 1/6W		01
R412	HF858100	Carbon Resistor	RD16S 100K J 1/6W		01
R413	HF859100	Carbon Resistor	RD16S 1M J 1/6W		01
R416	HF856100	Carbon Resistor	RD16S 1K J 1/6W		01
* R417	HX809360	Metal Film Resistor	CRB20 4.3K F 1/5W		
R418	HF858100	Carbon Resistor	RD16S 100K J 1/6W		01
* R419	HX809350	Metal Film Resistor	CRB20 3.9K F 1/5W		
* R420	HX809340	Metal Film Resistor	CRB20 1K F 1/5W		
* R421	HX809390	Metal Film Resistor	CRB20 10K F 1/5W		
* R422	HX809400	Metal Film Resistor	CRB20 33K F 1/5W		
* R423	HX809340	Metal Film Resistor	CRB20 1K F 1/5W		
R424	HF856100	Carbon Resistor	RD16S 1K J 1/6W		01
R425	HF859100	Carbon Resistor	RD16S 1M J 1/6W		01
* R426	HX809380	Metal Film Resistor	CRB20 6.8K F 1/5W		
* R427	HX809400	Metal Film Resistor	CRB20 33K F 1/5W		
* R428	HX809370	Metal Film Resistor	CRB20 4.7K F 1/5W		
* R429	HX809410	Metal Film Resistor	CRB20 91K F 1/5W		

* : New Parts

RANK : Japan only

REF NO.	PART NO.	DESCRIPTION	REMARKS	QTY	RANK
R430	HF858100	Carbon Resistor	RD16S 100K J 1/6W		01
R431	HF856560	Carbon Resistor	RD16S 5.6K J 1/6W		01
R432	HF857120	Carbon Resistor	RD16S 12K J 1/6W		01
R433	HF857100	Carbon Resistor	RD16S 10K J 1/6W		01
R435	HF857510	Carbon Resistor	RD16S 51K J 1/6W		01
R436	HF857150	Carbon Resistor	RD16S 15K J 1/6W		01
R437	HF856330	Carbon Resistor	RD16S 3.3K J 1/6W		01
R438	HF856150	Carbon Resistor	RD16S 1.5K J 1/6W		01
R439	HF857100	Carbon Resistor	RD16S 10K J 1/6W		01
R440	HF856100	Carbon Resistor	RD16S 1K J 1/6W		01
R441	HF857100	Carbon Resistor	RD16S 10K J 1/6W		01
R442	HF853100	Carbon Resistor	RD16S 1.0 J 1/6W		01
R443	HF854100	Carbon Resistor	RD16S 10 J 1/6W		01
R444	HF856470	Carbon Resistor	RD16S 4.7K J 1/6W		01
R445	HF857470	Carbon Resistor	RD16S 47K J 1/6W		01
R446	HF856330	Carbon Resistor	RD16S 3.3K J 1/6W		01
R447	HF857470	Carbon Resistor	RD16S 47K J 1/6W		01
R448	HF859100	Carbon Resistor	RD16S 1M J 1/6W		01
R449	HF858100	Carbon Resistor	RD16S 100K J 1/6W		01
R501	HF856560	Carbon Resistor	RD16S 5.6K J 1/6W		01
R502	HF857220	Carbon Resistor	RD16S 22K J 1/6W		01
R503	HF856560	Carbon Resistor	RD16S 5.6K J 1/6W		01
R504	HF857220	Carbon Resistor	RD16S 22K J 1/6W		01
R505	HF856560	Carbon Resistor	RD16S 5.6K J 1/6W		01
R506	HF857220	Carbon Resistor	RD16S 22K J 1/6W		01
R507	HF856560	Carbon Resistor	RD16S 5.6K J 1/6W		01
R508	HF857220	Carbon Resistor	RD16S 22K J 1/6W		01
R509	HF856330	Carbon Resistor	RD16S 3.3K J 1/6W		01
R510	HF854220	Carbon Resistor	RD16S 22 J 1/6W		01
R511	HF857330	Carbon Resistor	RD16S 33K J 1/6W		01
R512	HF856470	Carbon Resistor	RD16S 4.7K J 1/6W		01
R513	HF857100	Carbon Resistor	RD16S 10K J 1/6W		01
R514	HF856390	Carbon Resistor	RD16S 3.9K J 1/6W		01
R515	HF857470	Carbon Resistor	RD16S 47K J 1/6W		01
R516	HF857470	Carbon Resistor	RD16S 47K J 1/6W		01
R517	HF856220	Carbon Resistor	RD16S 2.2K J 1/6W		01
R518	HF856470	Carbon Resistor	RD16S 4.7K J 1/6W		01
R519	HF856470	Carbon Resistor	RD16S 4.7K J 1/6W		01
R520	HF857150	Carbon Resistor	RD16S 15K J 1/6W		01
R521	HF857470	Carbon Resistor	RD16S 47K J 1/6W		01
R522	HF857100	Carbon Resistor	RD16S 10K J 1/6W		01
R523	HF857220	Carbon Resistor	RD16S 22K J 1/6W		01
R524	HF857220	Carbon Resistor	RD16S 22K J 1/6W		01
R525	HF857330	Carbon Resistor	RD16S 33K J 1/6W		01
R526	HF857100	Carbon Resistor	RD16S 10K J 1/6W		01
R527	HF857150	Carbon Resistor	RD16S 15K J 1/6W		01
R528	HF856560	Carbon Resistor	RD16S 5.6K J 1/6W		01
R529	HF856330	Carbon Resistor	RD16S 3.3K J 1/6W		01
R530	HF857330	Carbon Resistor	RD16S 33K J 1/6W		01
R531	HF857330	Carbon Resistor	RD16S 33K J 1/6W		01
R532	HF858470	Carbon Resistor	RD16S 470K J 1/6W		01
R533	HF854100	Carbon Resistor	RD16S 10 J 1/6W		01
R534	HF854100	Carbon Resistor	RD16S 10 J 1/6W		01
R535	HF857100	Carbon Resistor	RD16S 10K J 1/6W		01
R536	HF857100	Carbon Resistor	RD16S 10K J 1/6W		01
R537	HF858470	Carbon Resistor	RD16S 470K J 1/6W		01
R538	HF856470	Carbon Resistor	RD16S 4.7K J 1/6W		01
R539	HF856470	Carbon Resistor	RD16S 4.7K J 1/6W		01
R540	HF856560	Carbon Resistor	RD16S 5.6K J 1/6W		01
R541	HF858220	Carbon Resistor	RD16S 220K J 1/6W		01
R542	HF858100	Carbon Resistor	RD16S 100K J 1/6W		01
R543	HF853100	Carbon Resistor	RD16S 1.0 J 1/6W		01
R544	HF853100	Carbon Resistor	RD16S 1.0 J 1/6W		01
R545	HF856120	Carbon Resistor	RD16S 1.2K J 1/6W		01
R546	HF855560	Carbon Resistor	RD16S 560 J 1/6W		01
TP101	--	Connector Base Post	2P PH-B2B		
-103	--	Connector Base Post	2P PH-B2B		
TP201	--	Connector Base Post	2P PH-B2B		
-203	--	Connector Base Post	2P PH-B2B		
TP301	--	Connector Base Post	2P PH-B2B		

*: New Parts

RANK : Japan only

REF NO.	PART NO.	DESCRIPTION	REMARKS	QTY	RANK
-303	--	Connector Base Post	2P PH-B2B		
TP401	--	Connector Base Post	2P PH-B2B		
-403	--	Connector Base Post	2P PH-B2B		
TP501	--	Connector Base Post	2P PH-B2B		
TP601	--	Connector Base Post	5P PH-B5B		
* VR101	HX809270	Trimmer Potentiometer	EVND8AA03B12 100-B		
* VR102	HX809310	Trimmer Potentiometer	EVND8AA03B14 10K-B		
* VR103	HX809300	Trimmer Potentiometer	EVND8AA03BE3 2.2KB		
* VR104	HX809320	Trimmer Potentiometer	EVND8AA03BQ4 47K-B		
* VR105	HX809330	Trimmer Potentiometer	EVND8AA03B15 100KB		
* VR201	HX809270	Trimmer Potentiometer	EVND8AA03B12 100-B		
* VR202	HX809310	Trimmer Potentiometer	EVND8AA03B14 10K-B		
* VR203	HX809300	Trimmer Potentiometer	EVND8AA03BE3 2.2KB		
* VR204	HX809320	Trimmer Potentiometer	EVND8AA03BQ4 47K-B		
* VR205	HX809330	Trimmer Potentiometer	EVND8AA03B15 100KB		
* VR301	HX809270	Trimmer Potentiometer	EVND8AA03B12 100-B		
* VR302	HX809310	Trimmer Potentiometer	EVND8AA03B14 10K-B		
* VR303	HX809300	Trimmer Potentiometer	EVND8AA03BE3 2.2KB		
* VR304	HX809320	Trimmer Potentiometer	EVND8AA03BQ4 47K-B		
* VR305	HX809330	Trimmer Potentiometer	EVND8AA03B15 100KB		
* VR401	HX809270	Trimmer Potentiometer	EVND8AA03B12 100-B		
* VR402	HX809310	Trimmer Potentiometer	EVND8AA03B14 10K-B		
* VR403	HX809300	Trimmer Potentiometer	EVND8AA03BE3 2.2KB		
* VR404	HX809320	Trimmer Potentiometer	EVND8AA03BQ4 47K-B		
* VR405	HX809330	Trimmer Potentiometer	EVND8AA03B15 100KB		
* VR501	HX809290	Trimmer Potentiometer	EVN8AA03B13 1K-B		
* VR502	HX809280	Trimmer Potentiometer	EVND8AA03BQ2 470-B		
* NX820160		Circuit Board	SUB 3/3		
* NX820170		Circuit Board	SUB 2/3		
* NX820180		Circuit Board	SUB 1/3		
EP600190		Bind Head Screw	M3X8		
--		Jumper Wire	5mm		
--		Jumper Wire	10mm		
* C101	FX804470	Electrolytic Cap.	UVR1H 0.22 M 50V		
* C102	FX804270	Electrolytic Cap.	UVR1H 10 M 50V		
* -105	FX804270	Electrolytic Cap.	UVR1H 10 M 50V		
C106	V1307100	Ceramic Capacitor	UP050 0.1 FZ 50V		01
-109	V1307100	Ceramic Capacitor	UP050 0.1 FZ 50V		01
* C110	FX804440	Ceramic Capacitor	EP050 0.01 YN 16V		
C111	UA653470	Mylar Capacitor	ECQB1H 0.047 J 50V		01
* C112	FX804270	Electrolytic Cap.	UVR1H 10 M 50V		
* C113	FX804320	Ceramic Capacitor	RPU07 0.01 F Z 50V		
* C114	FX804320	Ceramic Capacitor	RPU07 0.01 F Z 50V		
* C115	FX804460	Electrolytic Cap.	UVR1E 4700 M 25V		
* C201	FX804470	Electrolytic Cap.	UVR1H 0.22 M 50V		
* C202	FX804270	Electrolytic Cap.	UVR1H 10 M 50V		
* C301	FX804470	Electrolytic Cap.	UVR1H 0.22 M 50V		
* C302	FX804270	Electrolytic Cap.	UVR1H 10 M 50V		
* C401	FX804470	Electrolytic Cap.	UVR1H 0.22 M 50V		
* C402	FX804270	Electrolytic Cap.	UVR1H 10 M 50V		
CN101	--	Wire Trap	52147-0810 8P		
CN102	--	Wire Trap	52147-0810 8P		
CN103	--	Cable Holder	51048-1200 12P		
CN103	--	Flat Cable	12P L190		
CN104	--	Cable Holder	51048-1500 15P		
CN104	--	Flat Cable	15P L190		
CN107	--	Wire Trap	52147-0810 8P		
CN108	--	Wire Trap	52147-0410 4P		
CN109	--	Cable Holder	51048-0700 7P		
CN109	--	Flat Cable	7P L50		
D101	VT525700	LED	SLR-342VRTC7	CH1 Level Meter +6,+3,0	01
-103	VT525700	LED	SLR-342VRTC7		01
D104	VT525600	LED	SLR-342GTC7	CH1 Level Meter -5	01
D105	VT525600	LED	SLR-342GTC7	CH1 Level Meter -10	01
D106	VT525700	LED	SLR-342VRTC7	REC1	01
D107	IF004600	Diode	1SS133(T-7)		01
D108	VT525600	LED	SLR-342GTC7	POWER	01
D109	VE243700	Diode	RB100A		01
D110	VU652800	Diode	1SR139-400(T-32)		01

* : New Parts

RANK : Japan only

REF NO.	PART NO.	DESCRIPTION		REMARKS	QTY	RANK
D111	VU652800	Diode	1SR139-400(T-32)			01
D201	VT525700	LED	SLR-342VRTC7	CH2 Level Meter +6,+3.0		01
-203	VT525700	LED	SLR-342VRTC7			01
D204	VT525600	LED	SLR-342GTC7	CH2 Level Meter -5		01
D205	VT525600	LED	SLR-342GTC7	CH2 Level Meter -10		01
D206	VT525700	LED	SLR-342VRTC7	REC2		01
D301	VT525700	LED	SLR-342VRTC7	CH3 Level Meter +6,+3.0		01
-303	VT525700	LED	SLR-342VRTC7			01
D304	VT525600	LED	SLR-342GTC7	CH3 Level Meter -5		01
D305	VT525600	LED	SLR-342GTC7	CH3 Level Meter -10		01
D306	VT525700	LED	SLR-342VRTC7	REC3		01
D401	VT525700	LED	SLR-342VRTC7	CH4 Level Meter +6,+3.0		01
-403	VT525700	LED	SLR-342VRTC7			01
D404	VT525600	LED	SLR-342GTC7	CH4 Level Meter -5		01
D405	VT525600	LED	SLR-342GTC7	CH4 Level Meter -10		01
D406	VT525700	LED	SLR-342VRTC7	REC4		01
FT001	--	Heat Sink	OSH-1025-SPL			
IC101	XA534A00	IC	BA6137	LED DRIVER		03
IC102	XR833A00	IC	UPC2410AHF	REGULATOR +12V		04
IC201	XA534A00	IC	BA6137	LED DRIVER		03
IC301	XA534A00	IC	BA6137	LED DRIVER		03
IC401	XA534A00	IC	BA6137	LED DRIVER		03
* JK107	LX804950	DC Power Jack	YKB31-0001A	DC 12V		
* PJ101	LX804930	Pin Connector	YKC21-3041 4P	STEREO OUT L/R		
* PJ102	LX804940	Pin Connector	YKB11-0273 1P	MONITOR OUT L/R		
Q101	IX807670	Transistor	2SA1300-BL	SYNC OUT		01
* Q103	IX808890	Digital Transistor	DTC143TSA-TP			
* Q104	IX808890	Digital Transistor	DTC143TSA-TP			
* Q105	IX808890	Digital Transistor	DTC143TSA-TP			
* Q106	IX808890	Digital Transistor	DTC143TSA-TP			
R08	HF855910	Carbon Resistor	RD16S 910 J 1/6W			01
R100	HF856330	Carbon Resistor	RD16S 3.3K J 1/6W			01
R101	HF857100	Carbon Resistor	RD16S 10K J 1/6W			01
R102	HF856470	Carbon Resistor	RD16S 4.7K J 1/6W			01
R103	HF855330	Carbon Resistor	RD16S 330 J 1/6W			01
R104	HF857100	Carbon Resistor	RD16S 10K J 1/6W			01
R105	HF856150	Carbon Resistor	RD16S 1.5K J 1/6W			01
R106	HF855680	Carbon Resistor	RD16S 680 J 1/6W			01
R107	HF856100	Carbon Resistor	RD16S 1K J 1/6W			01
R109	HF855910	Carbon Resistor	RD16S 910 J 1/6W			01
R110	HF855680	Carbon Resistor	RD16S 680 J 1/6W			01
R111	HF855680	Carbon Resistor	RD16S 680 J 1/6W			01
R127	HF856100	Carbon Resistor	RD16S 1K J 1/6W			01
R128	HF856100	Carbon Resistor	RD16S 1K J 1/6W			01
R129	HF856100	Carbon Resistor	RD16S 1K J 1/6W			01
R130	HF857120	Carbon Resistor	RD16S 12K J 1/6W			01
R131	HF857100	Carbon Resistor	RD16S 10K J 1/6W			01
R200	HF856330	Carbon Resistor	RD16S 3.3K J 1/6W			01
R201	HF857100	Carbon Resistor	RD16S 10K J 1/6W			01
R202	HF856470	Carbon Resistor	RD16S 4.7K J 1/6W			01
R203	HF855330	Carbon Resistor	RD16S 330 J 1/6W			01
R231	HF857100	Carbon Resistor	RD16S 10K J 1/6W			01
R300	HF856330	Carbon Resistor	RD16S 3.3K J 1/6W			01
R301	HF857100	Carbon Resistor	RD16S 10K J 1/6W			01
R302	HF856470	Carbon Resistor	RD16S 4.7K J 1/6W			01
R303	HF855330	Carbon Resistor	RD16S 330 J 1/6W			01
R331	HF857100	Carbon Resistor	RD16S 10K J 1/6W			01
R400	HF856330	Carbon Resistor	RD16S 3.3K J 1/6W			01
R401	HF857100	Carbon Resistor	RD16S 10K J 1/6W			01
R402	HF856470	Carbon Resistor	RD16S 4.7K J 1/6W			01
R403	HF855330	Carbon Resistor	RD16S 330 J 1/6W			01
R431	HF857100	Carbon Resistor	RD16S 10K J 1/6W			01
* SW101	KX804860	Slide Switch	SSSU043-P06N1	REC SELECT 1		
* SW102	KX804840	Slide Switch	SSSU042-P06N1	METER SELECT		
* SW103	KX804850	Slide Switch	SSSU013-P06S1	dBx		
* SW104	KX804830	Slide Switch	SSSU012-P06N1	ZERO STOP		
* SW105	KX804820	Push Switch	ESB68149	TAPE SPEED CONTROL		
* SW106	KX804870	Push Switch	ESB92S23B	POWER ON/OFF		
* SW201	KX804860	Slide Switch	SSSU043-P06N1	REC SELECT 2		

*: New Parts

RANK : Japan only

