

HOME THEATER SOUND SYSTEM DVX-S200

DVR-S200/NX-P200

SERVICE MANUAL

The DVX-S200 is composed of the DVR-S200 and the NX-P200.

DVX-S200 は DVR-S200 と NX-P200 で構成されています。

IMPORTANT NOTICE

This manual has been provided for the use of authorized YAMAHA Retailers and their service personnel. It has been assumed that basic service procedures inherent to the industry, and more specifically YAMAHA Products, are already known and understood by the users, and have therefore not been restated.

WARNING: Failure to follow appropriate service and safety procedures when servicing this product may result in personal injury, destruction of expensive components, and failure of the product to perform as specified. For these reasons, we advise all YAMAHA product owners that any service required should be performed by an authorized YAMAHA Retailer or the appointed service representative.

IMPORTANT: The presentation or sale of this manual to any individual or firm does not constitute authorization, certification or recognition of any applicable technical capabilities, or establish a principle-agent relationship of any form.

The data provided is believed to be accurate and applicable to the unit(s) indicated on the cover. The research, engineering, and service departments of YAMAHA are continually striving to improve YAMAHA products. Modifications are, therefore, inevitable and specifications are subject to change without notice or obligation to retrofit. Should any discrepancy appear to exist, please contact the distributor's Service Division.

WARNING: Static discharges can destroy expensive components. Discharge any static electricity your body may have accumulated by grounding yourself to the ground buss in the unit (heavy gauge black wires connect to this buss).

IMPORTANT: Turn the unit OFF during disassembly and part replacement. Recheck all work before you apply power to the unit.

■ CONTENTS

TO SERVICE PERSONNEL	2-4	DVR-S200 ADJUSTMENT / DVR-S200調整	22
PREVENTION OF ELECTRO STATIC DISCHARGE	4	DVR-S200 SELF DIAGNOSIS FUNCTION (DIAG) /	
LOCALE MANAGEMENT INFORMATION	5	DVR-S200自己診断機能 (ダイアグ)	23-45
SYSTEM COMPOSITION / システム構成	5	DVR-S200 DVD DIAG MODE /	
FRONT PANELS	6-7	DVR-S200 DVDダイアグモード	46
REMOTE CONTROL PANELS	7	DISPLAY DATA	47
REAR PANELS	8-9	IC DATA	48-57
SPECIFICATIONS / 参考仕様	10-13	DVR-S200 BLOCK DIAGRAM	58-60
INTERNAL VIEW	14	DVR-S200 PRINTED CIRCUIT BOARD	61-70
DVR-S200 DISASSEMBLY PROCEDURES /		NX-SW200 PRINTED CIRCUIT BOARD	71
DVR-S200分解手順	15-19	DVR-S200 SCHEMATIC DIAGRAM	72-87
NX-SW200 DISASSEMBLY PROCEDURES /		NX-SW200 SCHEMATIC DIAGRAM	88
NX-SW200分解手順	20-21	PARTS LIST	89-107
DVR-S200 D-AMP MODULE TROUBLESHOOTING /		REMOTE CONTROL	108
DVR-S200 D-アンプモジュールの故障診断	22		



このサービスマニュアルは、エコマーク認定の再生紙を使用しています。
This Service Manual uses recycled paper.

100871

Copyright 2004 YAMAHA CORPORATION
This manual is copyrighted by YAMAHA and may not be copied or
redistributed either in print or electronically without permission.

 **YAMAHA**
YAMAHA CORPORATION
P.O. Box 1, Hamamatsu, Japan

■ TO SERVICE PERSONNEL

1. Critical Components Information

Components having special characteristics are marked \triangle and must be replaced with parts having specifications equal to those originally installed.

2. Leakage Current Measurement (For 120V Models Only)

When service has been completed, it is imperative to verify that all exposed conductive surfaces are properly insulated from supply circuits.

- Meter impedance should be equivalent to 1500 ohm shunted by 0.15 μ F.



“CAUTION”

“NX-SW200 F1 : FOR CONTINUED PROTECTION AGAINST RISK OF FIRE, REPLACE ONLY WITH SAME TYPE 2.0A, 125V FUSE.”

CAUTION

NX-SW200 F1 : REPLACE WITH SAME TYPE 2.0A, 125V FUSE.

ATTENTION

NX-SW200 F1 : UTILISER UN FUSIBLE DE RECHANGE DE MEME TYPE DE 2.0A, 125V.

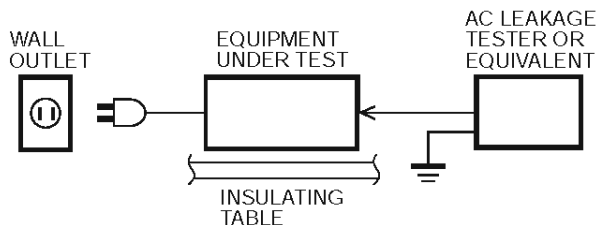

- Leakage current must not exceed 0.5mA.
- Be sure to test for leakage with the AC plug in both polarities.

WARNING: CHEMICAL CONTENT NOTICE!

The solder used in the production of this product contains LEAD. In addition, other electrical/electronic and/or plastic (where applicable) components may also contain traces of chemicals found by the California Health and Welfare Agency (and possibly other entities) to cause cancer and/or birth defects or other reproductive harm.

DO NOT PLACE SOLDER, ELECTRICAL/ELECTRONIC OR PLASTIC COMPONENTS IN YOUR MOUTH FOR ANY REASON WHATSOEVER!

Avoid prolonged, unprotected contact between solder and your skin! When soldering, do not inhale solder fumes or expose eyes to solder/flux vapor!

If you come in contact with solder or components located inside the enclosure of this product, wash your hands before handling food.

About lead-free solder / 無鉛ハンダについて

The foil side of MAIN P.C.B., FL P.C.B. and SUB P.C.B. used for the DVR-S200 are soldered with lead-free soldering material which is an alloy of Sn+Ag+Cu (tin + silver + copper). For the soldering points other than the above, lead solder is used.

Among some types of lead-free solder currently available, it is recommended to use one of the following types for the repair work.

- Sn + Ag + Cu (tin + silver + copper)
- Sn + Cu (tin + copper)
- Sn + Zn + Bi (tin + zinc + bismuth)

Caution:

1. As the melting point temperature of the lead-free solder is about 30°C to 40°C (50°F to 70°F) higher than that of the lead solder, be sure to use a soldering iron suitable to each solder.
2. If lead solder must be used, be sure to remove lead-free solder from each terminal section of the parts to be replaced and from the area around it completely before soldering, or make sure that the lead-free solder and lead solder melt together fully.

DVR-S200に使用されているMAIN基板、FL基板およびSUB基板のハンダ面のハンダ付けには、Sn+Ag+Cu（錫+銀+銅）の合金である無鉛ハンダが使用されています。なお、上記以外のハンダ付けには鉛入りハンダが使用されています。

無鉛ハンダにはいくつかの種類がありますが、修理時には下記のような無鉛ハンダの使用を推奨します。

- Sn+Ag+Cu（錫+銀+銅）
- Sn+Cu（錫+銅）
- Sn+Zn+Bi（錫+亜鉛+ビスマス）

注意：

1. 無鉛ハンダの融点温度は通常の鉛入りハンダに比べ30～40℃程度高くなっていますので、それぞれのハンダに合ったハンダごてをご使用ください。
2. 鉛入りハンダを使わざるを得ない場合は、あらかじめ交換する部品端子部やその周辺部の無鉛ハンダをすべて取り除くか、あるいは無鉛ハンダと鉛入りハンダが十分に溶けた状態となるようにハンダ付けしてください。

WARNING: Laser Safety

This product contains a laser beam component. This component may emit invisible, as well as visible radiation, which may cause eye damage. To protect your eyes and skin from laser radiation, the following precautions must be used during servicing of the unit.

- 1) When testing and/or repairing any component within the product, keep your eyes and skin more than 30 cm away from the laser pick-up unit at all times. Do not stare at the laser beam at any time.
- 2) Do not attempt to readjust, disassemble or repair the laser pick-up, unless noted elsewhere in this manual.
- 3) CAUTION : Use of controls, adjustments or performance of procedures other than those specified herein may result in hazardous radiation exposure.

Laser Emitting conditions:

- 1) When the Top Cover is removed, and the STANDBY/ON SW is turned to the "ON" position, the laser component will emit a beam for several seconds to detect if a disc is present. During this time (5-10 sec.) the laser may radiate through the lens of the laser pick-up unit. Do not attempt any servicing during this period! If no disc is detected, the laser will stop emitting the beam. When a disc is loaded, you will not be exposed to any laser emissions.
- 2) The laser power level can be adjusted with the VR on the pick-up PWB, however, this level has been set by the factory prior to shipping from the factory. Do not adjust this laser level control unless instruction is provided elsewhere in this manual. Adjustment of this control can increase the laser emission level from the device.

Laser Diode Properties

Type:	Semiconductor laser GaAlAs
Wave length:	650 nm (DVD) 790 nm (VCD/CD)
Output Power:	1.45 mW (DVD) 1.31 mW (VCD/CD)
Beam divergence:	60 degree

警告：レーザーの安全対策

本機はレーザー光線を放射する部品を搭載しています。この部品が放射するレーザー光線は目に損傷を起します。このレーザー光線から目及び肌を保護するために、本機の修理作業中は下記の注意を厳守してください。

- 1) テスト時または修理時、目及び肌を光ピックアップから30cm以上離してください。いかなる場合もレーザー光線を見つめないでください。
- 2) 光ピックアップの再調整及び分解はしないでください。
- 3) このマニュアル上で指定されている以外の制御、調整、手順はレーザー光線を照射される結果を招く恐れがあります。

レーザー放射条件

- 1) トップカバーを取り外しSTANDBY/ONスイッチをONにすると、ディスク検知のため5～10秒間、光ピックアップからレーザー光線が放射されます。この間、修理はしないでください。
ディスクが検知されなければ、レーザー光線の放射は停止します。ディスクがセットされている場合、ディスクで遮られるのでレーザー光線は修理担当者に届きません。
- 2) レーザーパワーレベルは光ピックアップ基板上のVRにより調整可能ですが、工場出荷前に調整セット済みなので、このVRは廻さないでください。このVRを廻すと装置からのレーザー光線の放射レベルが上がる恐れがあります。

レーザー

タイプ	半導体レーザー GaAlAs
波長	650 nm (DVD) 790 nm (VCD/CD)
出力	1.45 mW (DVD) 1.31 mW (VCD/CD)
ビーム広がり	60 度

VARO! : AVATTAESSA JA SUOJALUKITUS OHITETTAESSA OLET ALTTIINA NÄKYMÄTTÖMÄLLE LASER-SÄTEILYLLE. ÄLÄ KATSO SÄTEESEEN.

WARNING! : OSYNLIG LASERSTRÅLNING NÄR DENNA DEL ÄR ÖPPNAD OCH SPÄRREN ÄR URKOPPLAD. BETRakta EJ STRÅLEN.

WARNING

The use of optical instruments with this product will increase eye hazard.
Repair handling should take place as much as possible with a disc loaded inside the player.

U, C, R, K, A, G, B, L models

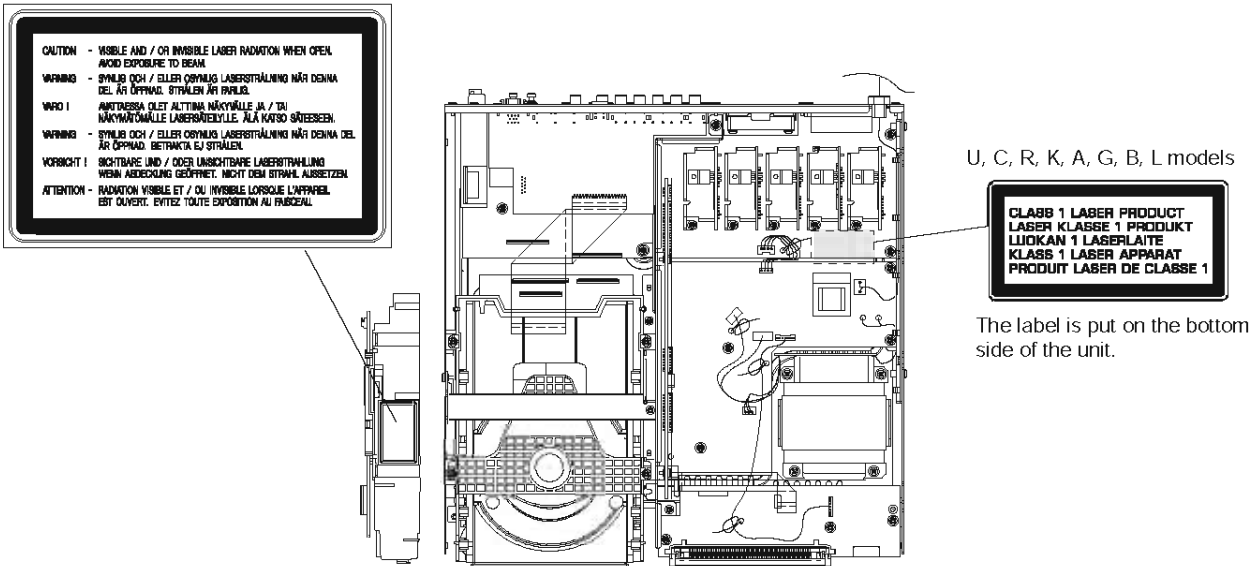

■ PREVENTION OF ELECTRO STATIC DISCHARGE

The laser diode in the traverse unit (optical pickup) may be damaged due to static electricity from clothes or the human body. Use caution to prevent electrostatic damage when servicing or handling the laser diode.

1. Grounding for electrostatic damage prevention

Some devices, such as the DVD player, use an optical pickup (laser diode) that will be damaged by static electricity in the working environment. Only attempt service after ensuring that all grounding procedures have been completed.

1. Worktable grounding
Put a grounded conductive material (sheet) or iron sheet on the area where the optical pickup is placed.
2. Human body grounding
Use an anti-static wrist strap to discharge the static electricity from your body.

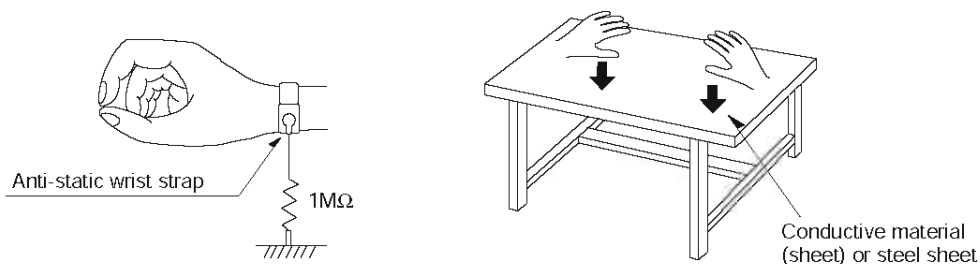

2. Handling of the optical pickup

1. To prevent damage to the optical pickup replacement parts during transportation and before installation, both ends of the laser diode are short-circuited. After installing the new part, remove the short circuit according to the correct procedure in this service manual.
2. Do not use a tester to check the laser diode in the optical pickup. The power supply in the tester will damage the laser diode.

3. Handling Precautions for the Traverse Unit (Optical Pickup)

1. Handle the traverse unit (optical pickup) gently, as it is an extremely high-precision assembly.
2. The flexible cable lines may break if an excessive force is applied to it. Use caution when handling the cable.
3. The semi-fixed resistor for laser power adjustment should not be adjusted. Do not turn the resistor.

■ LOCALE MANAGEMENT INFORMATION

Locale Management Information : This DVD player is designed and manufactured to respond to the Locale Management Information that is recorded on a DVD disc. If the Locale number described on the DVD disc does not correspond to the Locale number of this DVD player, this DVD player cannot play this disc.

This product incorporates copyright protection technology that is protected by method claims of certain U.S. patents and other intellectual property rights owned by Macrovision Corporation and other rights owners. Use of this copyright protection technology must be authorized by Macrovision Corporation, and is intended for home and other limited viewing uses only unless otherwise authorized by Macrovision Corporation. Reverse engineering or disassembly is prohibited.

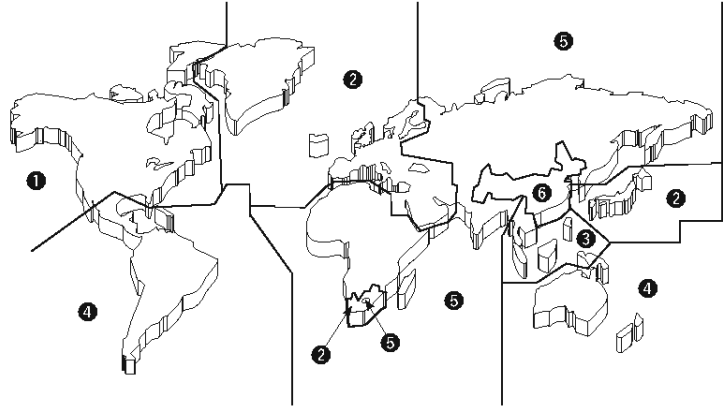

■ SYSTEM COMPOSITION / システム構成

The DVX-S200 is composed of the DVR-S200 and the NX-P200.

DVR-S200

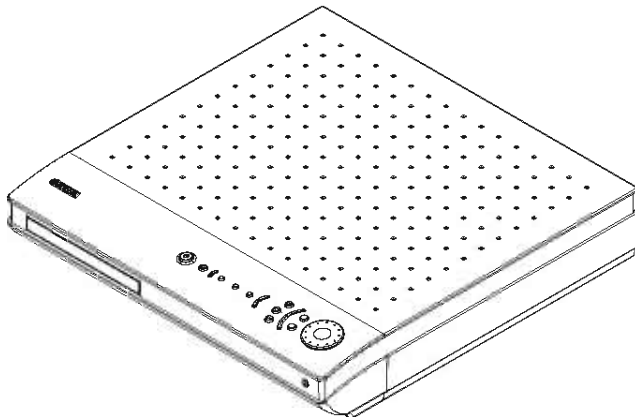

NX-P200

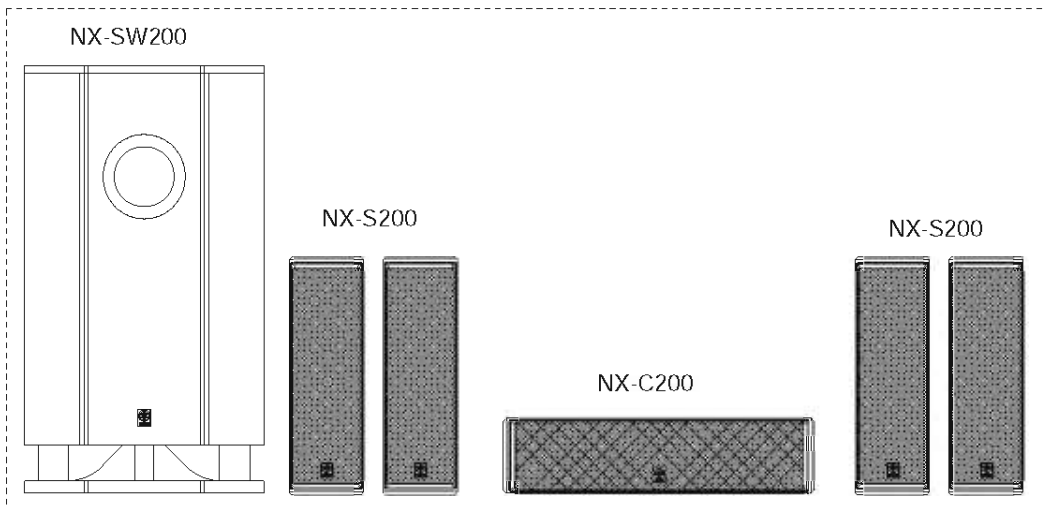

DVR-S200/NX-P200

FRONT PANELS

▼ DVR-S200

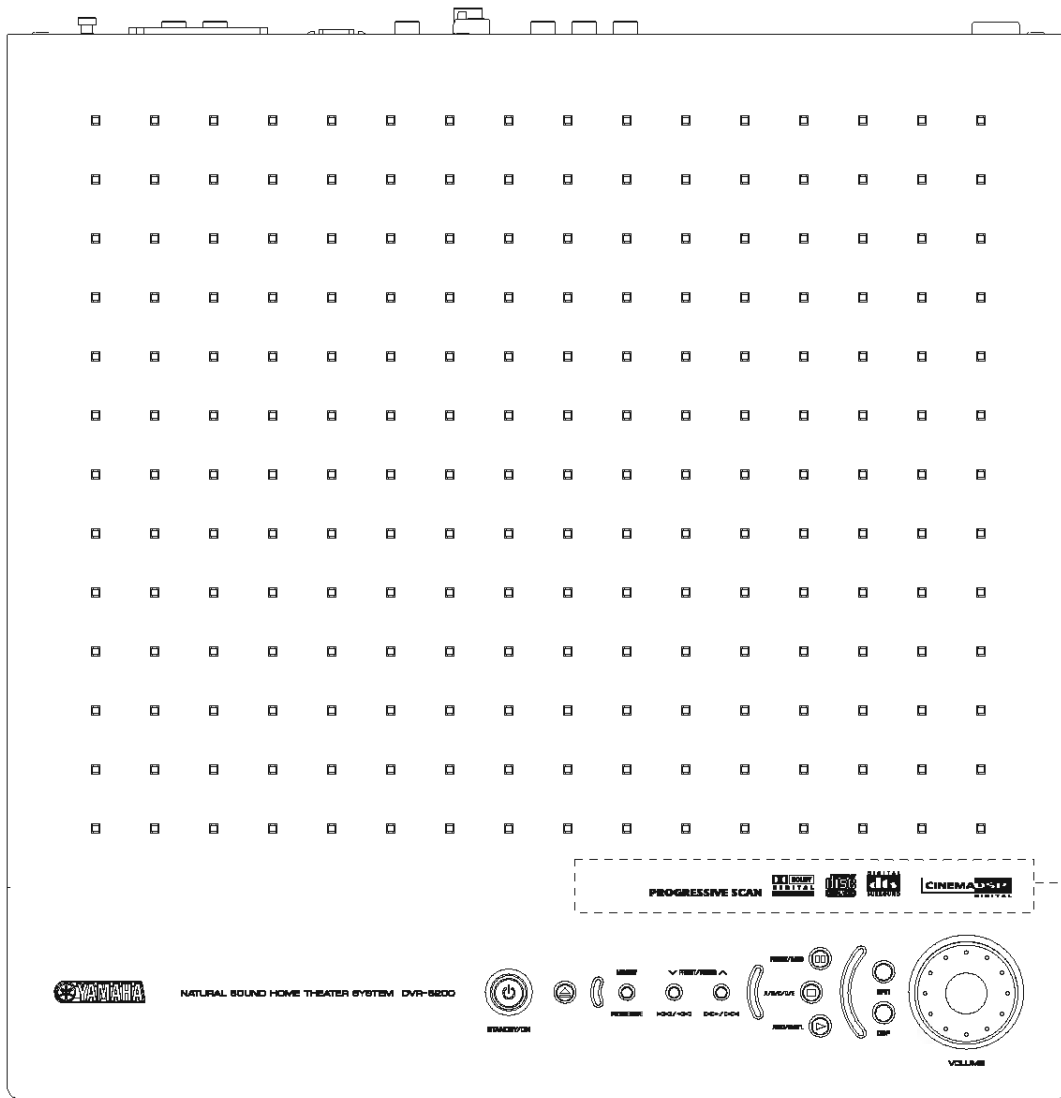
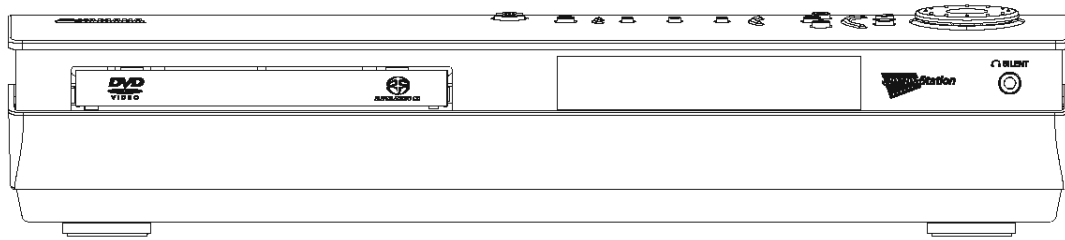

U, C, R, K, A, L models



B, G models



J model



▼ NX-SW200

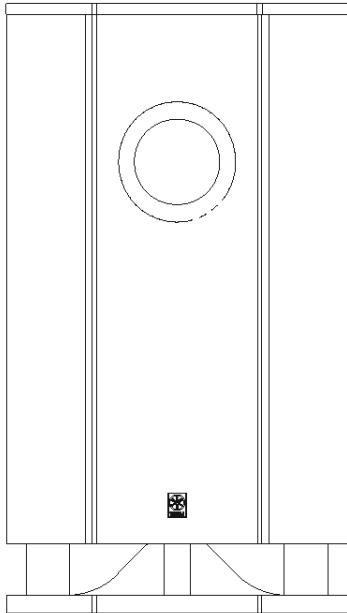

▼ NX-C200

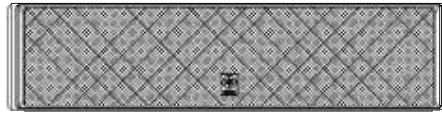

▼ NX-S200

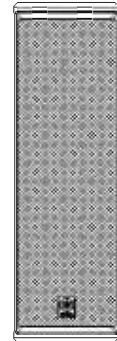

■ REMOTE CONTROL PANELS

▼ J model

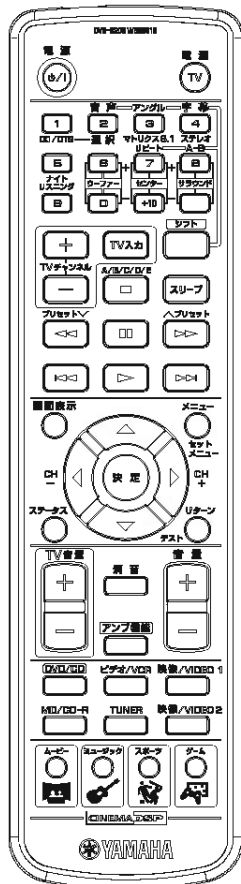

▼ U, C, R, K, A, L models

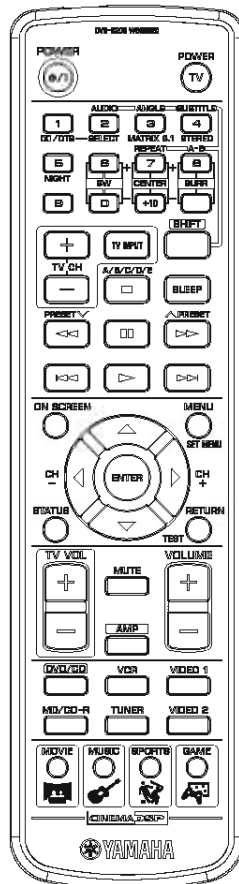

▼ B, G models

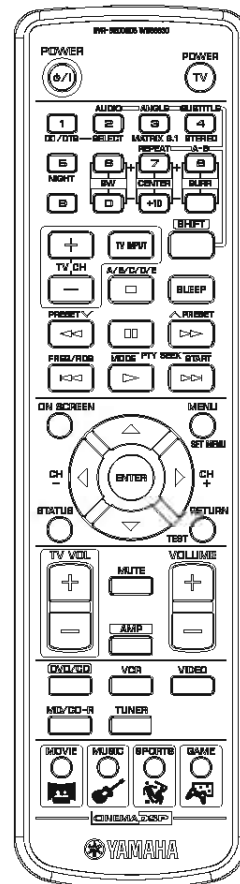

DVR-S200/NX-P200

REAR PANELS

▼ DVR-S200 (U, C, R, K, A, L models)

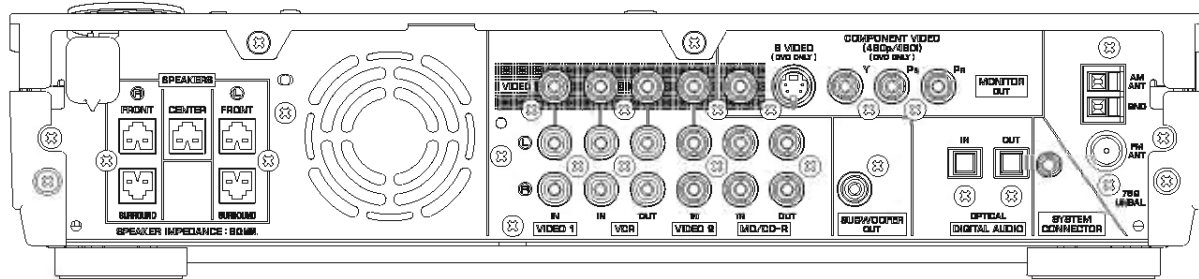

▼ DVR-S200 (B, G models)

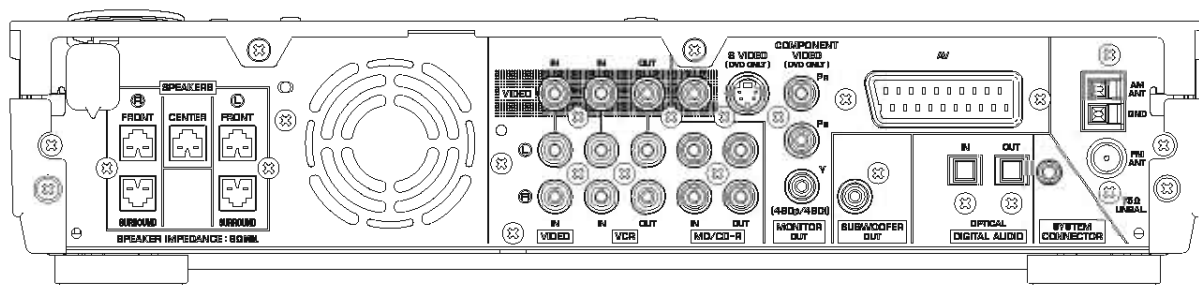

▼ DVR-S200 (J model)

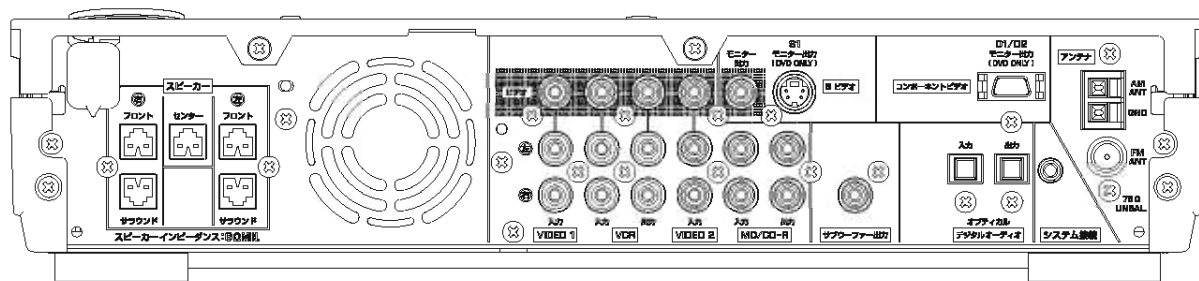

▼ NX-S200

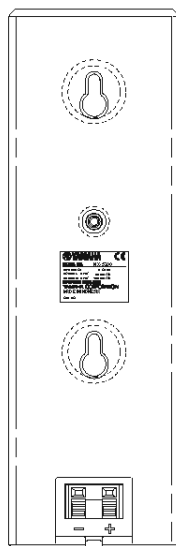

▼ NX-C200

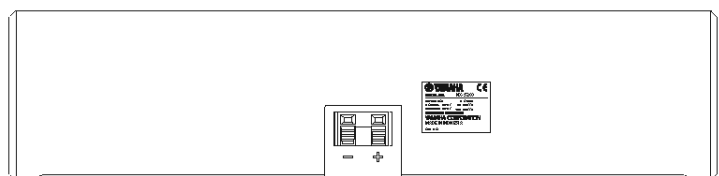

▼ NX-SW200 (U, C models)

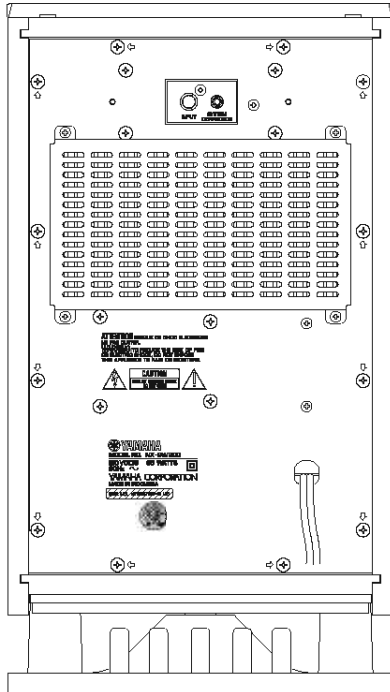

▼ NX-SW200 (R, L models)

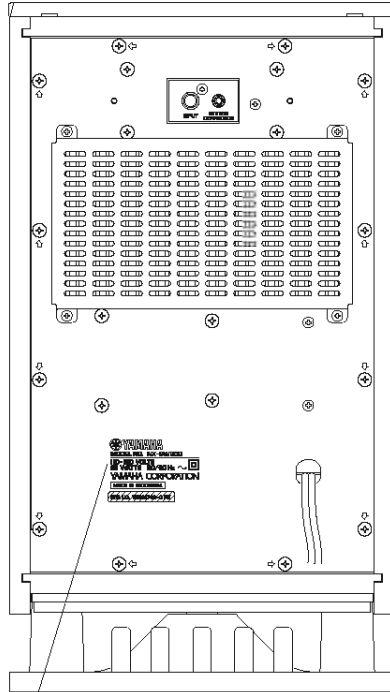

R model: 110-220 VOLTS
L model: 220-240 VOLTS

▼ NX-SW200 (B, G models)

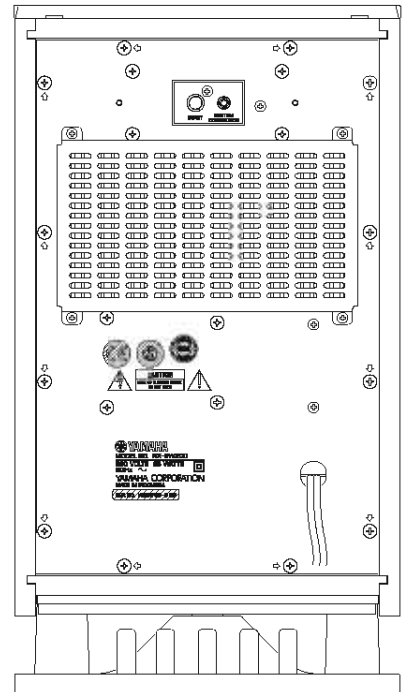

▼ NX-SW200 (K model)

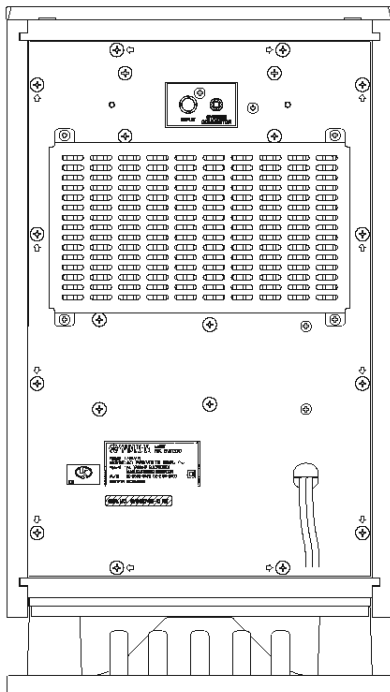

▼ NX-SW200 (A model)

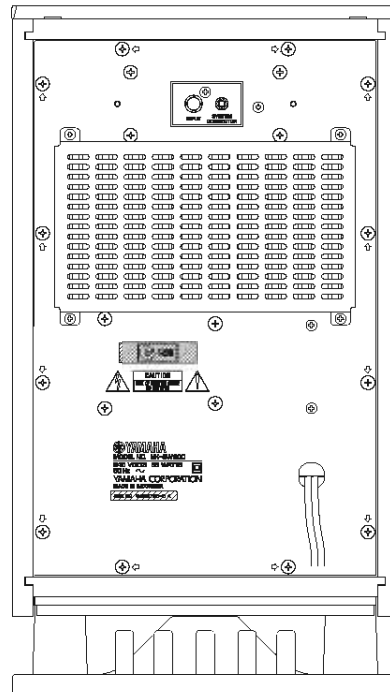

▼ NX-SW200 (J model)

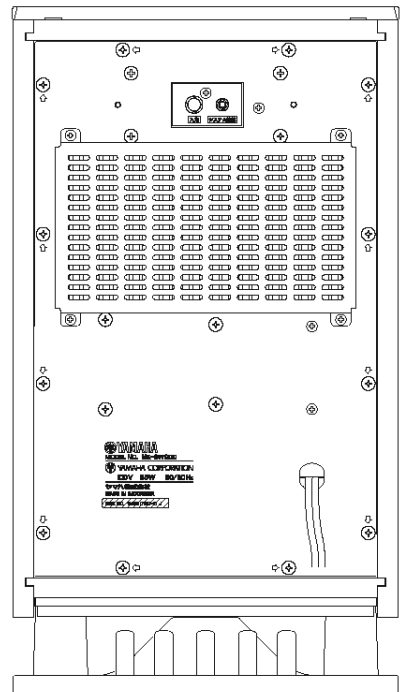

■ SPECIFICATIONS / 参考仕様

DVR-S200

INPUT OUTPUT SECTION / 入出力

Input / 入力端子

AUDIO (Analog)	
B, G models	3
	VCR, VIDEO1, MD/CD-R
U, C, R, K, A, L, J models	4
	VCR, VIDEO1, VIDEO2, MD/CD-R
AUDIO (Optical)	1
	MD/CD-R
VIDEO (Composite)	
B, G models	2
	VCR, VIDEO1
U, C, R, K, A, L, J models	3
	VCR, VIDEO1, VIDEO2

Output / 出力端子

SPEAKER OUT	5 ch
REC OUT	
AUDIO (Analog)	2
	VCR, MD/CD-R
AUDIO (Optical)	1
	MD/CD-R
VIDEO (Composite)	1
	VCR
MONITOR OUT	
VIDEO (Composite)	1
S-VIDEO (DVD only)	1
VIDEO-COMPONENT (Except for J)(DVD only)	1
SCART Terminal (B, G only)	1
D Terminal (J only)(DVD only)	1
SUBWOOFER PRE OUT	1

PHONES OUT / ヘッドホン出力 Stereo Mini Jack

SYSTEM CONNECTOR / システム接続

..... Monoral Mini Jack

AMPLIFIER SECTION / オーディオ部

Maximum Power (EIAJ) / 実用最大出力

1 kHz, 10% THD, 6 Ω 100 W/ch

Input Sensitivity/Impedance / 入力感度/インピーダンス

VCR, VIDEO1, (VIDEO2), MD/CD-R 200 mV/47 kΩ

Maximum Input Signal (1kHz, 0.5 % THD) / 最大許容入力

VCR, VIDEO1, (VIDEO2), MD/CD-R 2.2 V

Output Level/Impedance / 出力電圧/インピーダンス

(when 1 kHz, 200 mV is input)

REC OUT 200 mV/1.2 kΩ

SUB WOOFER PRE OUT (50Hz) 4V

HEADPHONE 220 mV/100 Ω

Frequency Response / 周波数特性

SP OUT (FRONT L/R) (20 Hz to 40 kHz) 0/-3 dB

Signal to Noise Ratio (IHF-A Network) / S/N比

SP OUT (FRONT L/R)(Input shorted, 200mV) 95 dB

VIDEO SECTION (VCR, VIDEO1, (VIDEO2)) / ビデオ部

Video Signal Type / ビデオ信号方式 NTSC/PAL

Video Signal Level / ビデオ信号

Video 1 Vp-p/75 Ω

S-Video

Y 1 Vp-p/75 Ω

C 0.286 Vp-p/75 Ω

Maximum Input Level / 最大許容入力

VCR, VIDEO1, (VIDEO2) 1.5 Vp-p

Signal to Noise Ratio / S/N比

Monitor Out 50 dB

Frequency Response / 周波数帯域

Monitor Out (5 Hz to 10 MHz)

Video 0/-3 dB

S-Video 0/-3 dB

TUNER SECTION / チューナー部

FM Tuning Range / FM受信周波数範囲

U, C models 87.5 to 107.9 MHz

R, L models 87.5 to 108.0/87.50 to 108.00 MHz

K, A, B, G models 87.50 to 108.00 MHz

J model 76.0 to 90.0 MHz

AM Tuning Range / AM受信周波数範囲

U, C models 530 to 1710 kHz

R, L models 530 to 1710/531 to 1611 kHz

K, A, B, G, J models 531 to 1611 kHz

DVD SECTION / DVD部

Output Level / 出力レベル

REC OUT

DVD/VIDEO, CD/CD-DA (1 kHz, 0 dB) 2 ± 0.3 V

Signal to Noise Ratio / S/N比

REC OUT

DVD/VIDEO, CD/CD-DA (Weighted) 100 dB

Dynamic Range / ダイナミックレンジ

REC OUT

DVD 48 kHz, 24 bit 90 dB

CD-DA/VIDEO, CD 90 dB

Harmonic Distortion + Noise / 歪率 + ノイズ

REC OUT

DVD/VIDEO, CD/CD-DA 0.03 %

Frequency Response / 周波数特性

PRE OUT

CD-DA/VIDEO, CD 10 Hz to 20 kHz

DVD 48 kHz Sampling 10 Hz to 22 kHz

DVD 96 kHz Sampling 10 Hz to 44 kHz

Video Output / 映像信号出力 1 Vp-p/75 Ω

Y Output/S-Video Output / Y出力/S映像出力 1 Vp-p/75 Ω
C Output/S-Video Output / C出力/S映像出力	
NTSC 0.286 Vp-p/75 Ω
PAL 0.3 Vp-p/75 Ω
Y Output/Component Video Output / Y出力/コンポーネント出力 1.0 Vp-p/75 Ω
Pb Output/Component Video Output / Pb出力/コンポーネント出力 0.7 Vp-p/75 Ω
Pr Output/Component Video Output / Pr出力/コンポーネント出力 0.7 Vp-p/75 Ω
RGB SCART Output / RGB SCART出力	
B, G models 0.7 Vp-p/75 Ω

GENERAL / 総合

Power Supply / 電源電圧

U, C models AC 120 V, 60 Hz
R model AC 110-120 V, 50/60 Hz
K model AC 220 V, 60 Hz
A model AC 240 V, 50 Hz
G, B models AC 230 V, 50 Hz
L model AC 220-240 V, 50/60 Hz
J model AC 100 V, 50/60 Hz

Power Consumption / 消費電力

J model 140 W
U, C, R, K, A, B, G, L models 130 W

Standby Power Consumption / 待機時消費電力

U, C, K, A, B, G, J models 0.35 W
R, L models 0.5 W

Dimensions (W x H x D) / 寸法(幅×高さ×奥行き)

..... 360 x 80 x 370.2 mm
(14-3/16" x 3-1/8" x 14-9/16")

Weight / 質量 6.5 kg (14 lbs 5 oz)

Accessories / 付属品 Remote Control x 1

- Battery (size "UM-3", "R06") x 2
- Indoor FM antenna x 1
- AM loop antenna x 1
- Video Pin Cable (1.5m) x 1
- Speaker Cable (Front, Center: 5 m) x 3
- Speaker Cable (Surround: 15 m) x 2

* Specifications subject to change without notice.

- U USA model
- C Canadian model
- R General model
- K Korean model
- A Australian model
- B British model
- G European model
- L Singapore model
- J Japanese model

DIMENSIONS / 寸法図

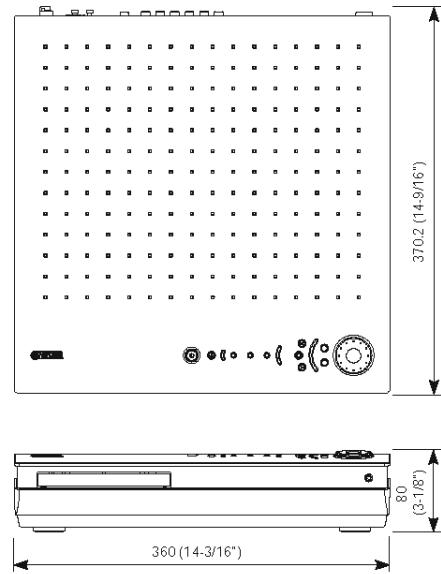

Unit : mm (inch)



Manufactured under license from Dolby Laboratories. "Dolby", "Pro Logic" and the double-D symbol are trademarks of Dolby Laboratories. ドルビーラボラトリーズからの実施権により製造されています。「ドルビー」、「PRO LOGIC」およびダブルD記号  は、ドルビーラボラトリーズの商標です。



"DTS" and "DTS Digital Surround" are registered trademarks of Digital Theater Systems, Inc. DTSおよびDTS デジタルサラウンドはデジタルシアターシステムの登録商標です。



AAC ロゴマーク  はドルビーラボラトリーズの登録商標です。

"SILENT CINEMA" is a trademark of YAMAHA CORPORATION. 「サイレントシアター / SILENT THEATER」はヤマハ株式会社の登録商標です。

DVR-S200/NX-P200

NX-P200

● NX-S200

Type / 型式 2-way Acoustic Suspension
Magnetic Shielding Type

Driver / スピーカーユニット

Tweeter 2.5 cm (1") Balanced Dome
Magnetic Shielding Type

Woofers 5 cm (2") Cone x 2
Magnetic Shielding Type

Frequency Response / 再生周波数帯域

..... 100 Hz to 40 kHz

Impedance / インピーダンス 6 Ω

Nominal Input / 許容入力 30 W

Maximum Input / 最大入力 100 W

Sensitivity / 出力音圧レベル 85 dB/2.83 V/m

Crossover Frequency / クロスオーバー周波数

..... 7 kHz

Input Terminal / 入力端子 Push Type

Dimensions (W x H x D) / 寸法(幅×高さ×奥行き)

..... 72 mm x 230 mm x 81 mm
(2-13/16" x 9-1/16" x 3-3/16")

Weight / 質量 1.0 kg (2 lbs. 3 oz.)

Finish / 仕上げ Silver

Accessories / 付属品 Nonskid Pads x 16
Mounting Bracket x 4, Screws x 4

Appropriate Speaker Stand / 適応スピーカースタンド SPS-200

Appropriate Speaker Bracket / 適応ブラケット SPM-8S

Speaker Bracket Accessory Screw Size M4 x 12

* Specifications subject to change without notice.

● NX-C200

Type / 型式 2-way Acoustic Suspension
Magnetic Shielding Type

Driver / スピーカーユニット

Tweeter 2.5 cm (1") Balanced Dome
Magnetic Shielding Type

Woofers 5 cm (2") Cone x 2
Magnetic Shielding Type

Frequency Response / 再生周波数帯域

..... 100 Hz to 40 kHz

Impedance / インピーダンス 6 Ω

Nominal Input / 許容入力 30 W

Maximum Input / 最大入力 100 W

Sensitivity / 出力音圧レベル 85 dB/2.83 V/m

Crossover Frequency / クロスオーバー周波数

..... 7 kHz

Input Terminal / 入力端子 Push Type

Dimensions (W x H x D) / 寸法(幅×高さ×奥行き)

..... 300 mm x 72 mm x 81 mm
(11-13/16" x 2-13/16" x 3-3/16")

Weight / 質量 1.1 kg (2 lbs. 6 oz.)

Finish / 仕上げ Silver

Accessories / 付属品 Fasteners x 2

* Specifications subject to change without notice.

● NX-S200

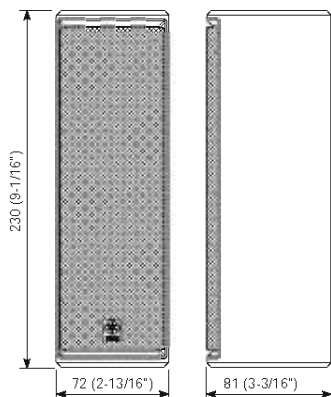

Unit : mm (inch)

● NX-C200

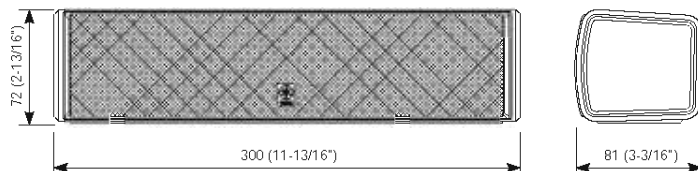

Unit : mm (inch)

● NX-SW200

Type / 型式	Advanced Yamaha Active Servo Technology
Output Power / 出力	100 W (100 Hz, 5 Ω, 10 % THD)
Dynamic Power / ダイナミックパワー	140 W, 5 Ω
Input Impedance / 入力インピーダンス	INPUT (PJ): 12 kΩ
Frequency Response / 再生周波数帯域	30 Hz to 200 Hz
Driver / スピーカーユニット	20 cm (8") Cone Magnetic Shielding Type

Input Section / 入力部

INPUT	RCA Pin Jack
SYSTEM CONNECTOR	Mono Mini Jack

Power Supply / 電源

U, C models	AC 120 V, 60 Hz
R model	AC 110-120 V, 50/60 Hz
K model	AC 220 V, 60 Hz
A model	AC 240 V, 50 Hz
B, G models	AC 230 V, 50 Hz
L model	AC 220-240 V, 50/60 Hz
J model	AC 100 V, 50/60 Hz

Power Consumption / 消費電力

U, C, A, B, G, R, K, L models	85 W
J model	55 W

Dimensions (W x H x D) / 寸法 (幅×高さ×奥行き)

	232 mm x 415 mm x 388 mm (9-1/8" x 16-5/16" x 15-1/4")
--	---

Weight / 質量 9.6 kg (21 lbs. 2 oz.)**Finish / 仕上げ** Silver

Accessories / 付属品 Subwoofer Cable (5m) x 1
 System Control Cable (5m) x 1
 Nonskid Pads x 4

* Specifications subject to change without notice.

● NX-SW200

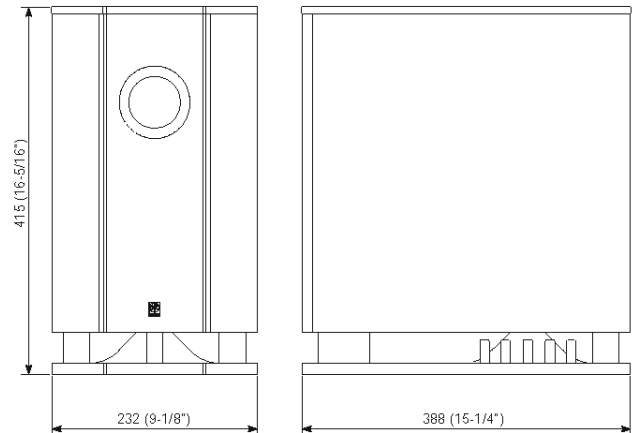

Unit : mm (inch)

U USA model
 C Canadian model
 R General model
 K Korean model
 A Australian model
 B British model
 G European model
 L Singapore model
 J Japanese model

INTERNAL VIEW

▼ DVR-S200

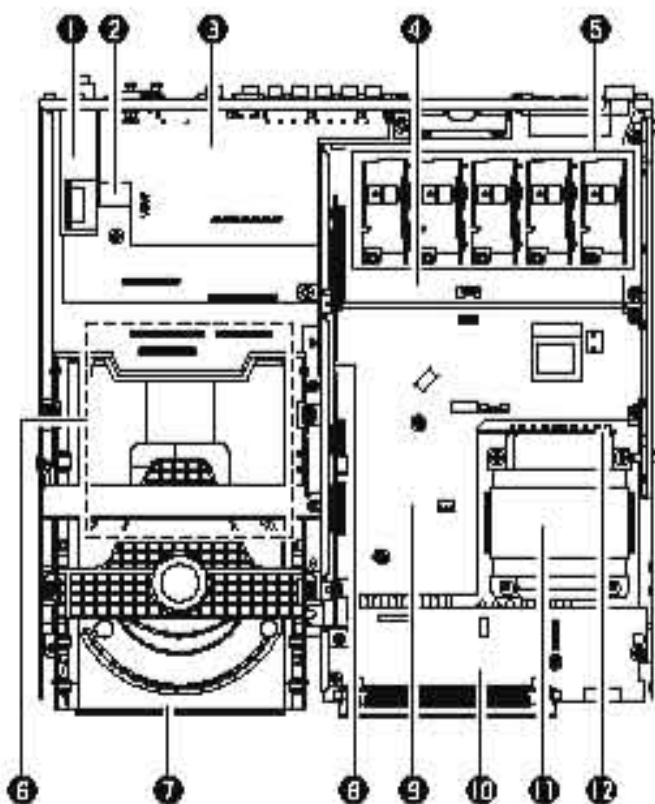

- ① AM/FM TUNER
- ② MAIN (2) P.C.B.
- ③ U, C, R, K, A, L, J models: MAIN (3) P.C.B.
B, G models: MAIN (4) P.C.B.
- ④ MAIN (1) P.C.B.
- ⑤ D-AMP MODULE
- ⑥ DIGITAL P.C.B.
- ⑦ DVD MECHANISM
- ⑧ SUB (3) P.C.B.
- ⑨ SUB (1) P.C.B.
- ⑩ FL P.C.B.
- ⑪ POWER TRANSFORMER
- ⑫ SUB (2) P.C.B.

▼ NX-SW200



- ① MAIN (1) P.C.B.
- ② MAIN (3) P.C.B.
- ③ MAIN (6) P.C.B.
- ④ DRIVER
- ⑤ MAIN (2) P.C.B.
- ⑥ POWER TRANSFORMER
- ⑦ MAIN (7) P.C.B.

■ DVR-S200 DISASSEMBLY PROCEDURES / DVR-S200分解手順

(Remove parts in disassembly order as numbered.)

(番号順に部品を取り外してください。)

1. Removal of Side Cover L/R

- a. Remove 1 screw (①) in Fig. 1.
- b. Lift the Side Cover L at the rear and move it rear-ward slantingly.
- c. Remove 1 screw (②) in Fig. 1.
- d. Lift the Side Cover R at the rear and move it rear-ward slantingly.

1. サイドカバーL/Rの外し方

- a. ①のネジ1本を外します。(Fig. 1)
- b. サイドカバーLを後方へスライドさせ取り外します。
- c. ②のネジ1本を外します。(Fig. 1)
- d. サイドカバーRを後方へスライドさせ取り外します。

2. Removal of Bottom Cover

- a. Remove 2 screws (③) in Fig. 2.
- b. Spread soft cloth and place this unit upside down on it.
- c. Remove 4 screws (④) in Fig. 2.
- d. Release 1 hook and remove the Bottom Cover toward the Front Panel side in Fig. 2.

2. ボトムカバーの外し方

- a. ③のネジ2本を外します。(Fig. 2)
- b. 柔らかい布を敷いた上に、本機を上下反転して置きます。(Fig. 2)
- c. ④のネジ4本を外します。(Fig. 2)
- d. フック1ヶ所を外し、ボトムカバーをフロントパネル側に外します。(Fig. 2)

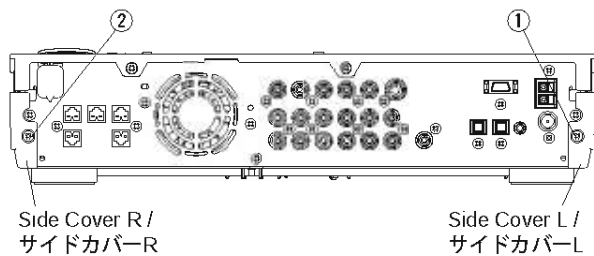
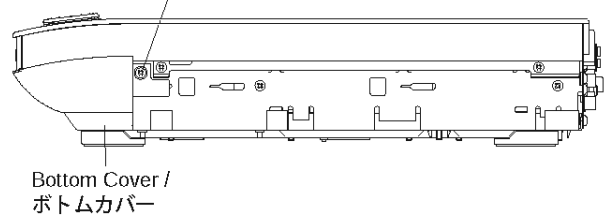
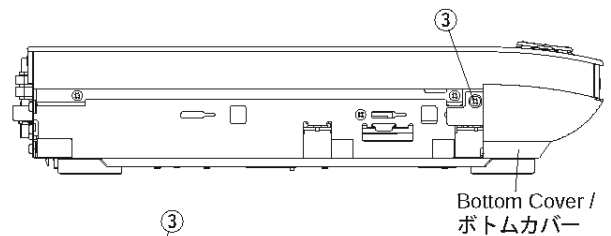

Fig. 1



● Bottom view

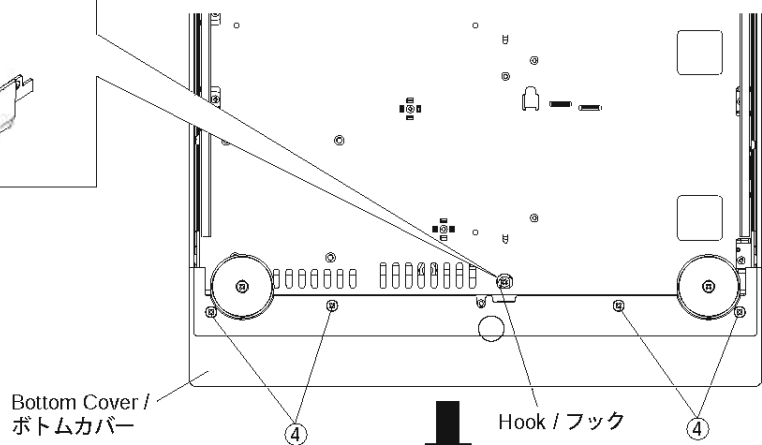
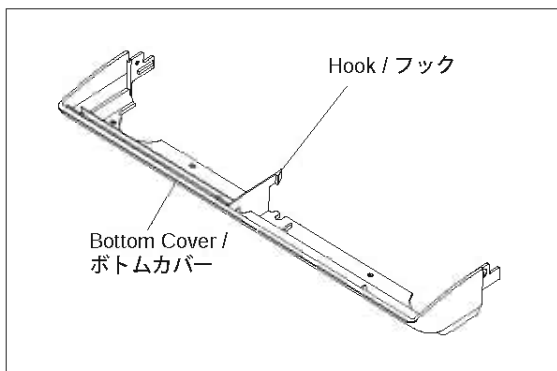

Fig. 2



● HOW TO MANUALLY EJECT THE TRAY

- Remove the Side Cover L/R.
- Remove the Bottom Cover.
- Move the slider in the direction indicated.
- Gently pull the tray out.

● 手動でトレイを開く方法

- サイドカバー-L/Rを外します。
- ボトムカバーを外します。
- スライダを矢印の方向に動かします。
- トレイをそっと引き出します。

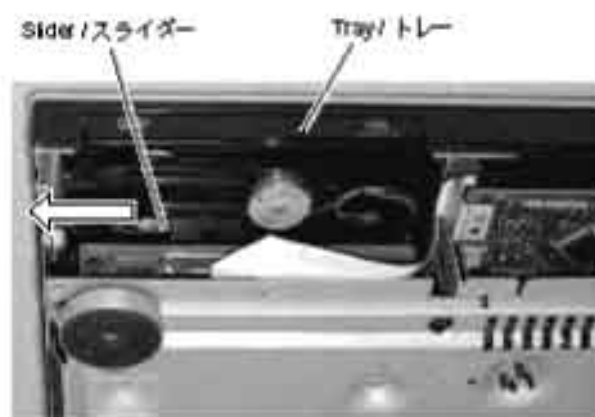

2. Removal of Top Unit

- Remove 1 screw (⑤) in Fig. 3.
- Turn this unit again to set it upside up.
- Remove 6 screws (⑥) and 2 screws (⑦) in Fig. 4.
- Disconnect the connector CB043 in Fig. 4.
- Remove the Top Unit.

3. トップユニットの外し方

- ⑤のネジ1本を外します。(Fig. 3)
- 再び、本機を上下反転して置きます。
- ⑥のネジ6本、⑦のネジ2本を外します。(Fig. 4)
- コネクタ-CB043を外します。(Fig. 4)
- トップユニットを外します。

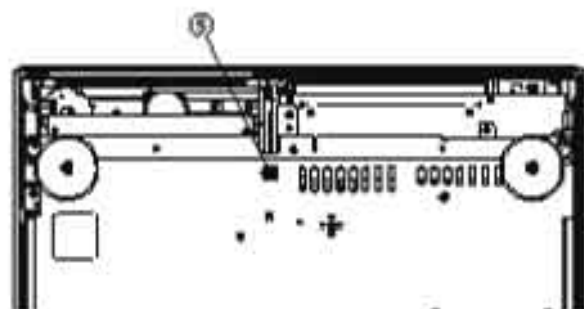

Fig. 3

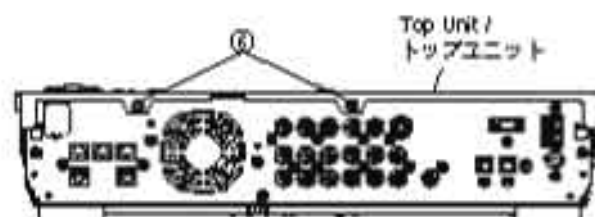
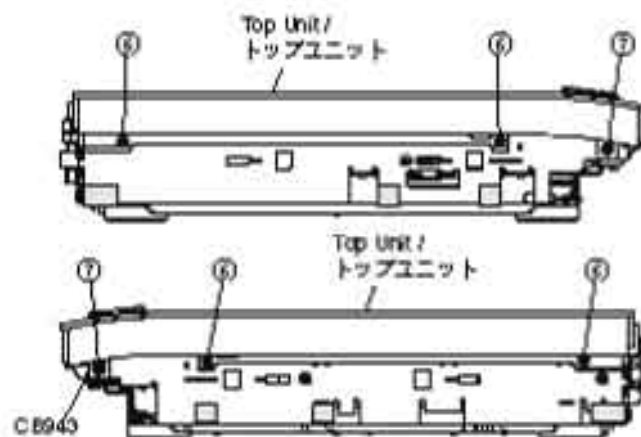

Fig. 4

4. Removal of DVD Mechanism

- Remove 2 screws (⑧) and then remove the Top Frame in Fig. 5.
- Remove 4 screws (⑨) and then remove the DVD Mechanism in Fig. 5.
- Disconnect the connectors CB302 and CB307 in Fig. 5.

4. DVDメカニズムの外し方

- ⑧のネジ2本を外し、トップフレームを外します。(Fig. 5)
- ⑨のネジ4本を外し、DVDメカニズムを外します。(Fig. 5)
- コネクタCB302、CB307を外します。(Fig. 5)

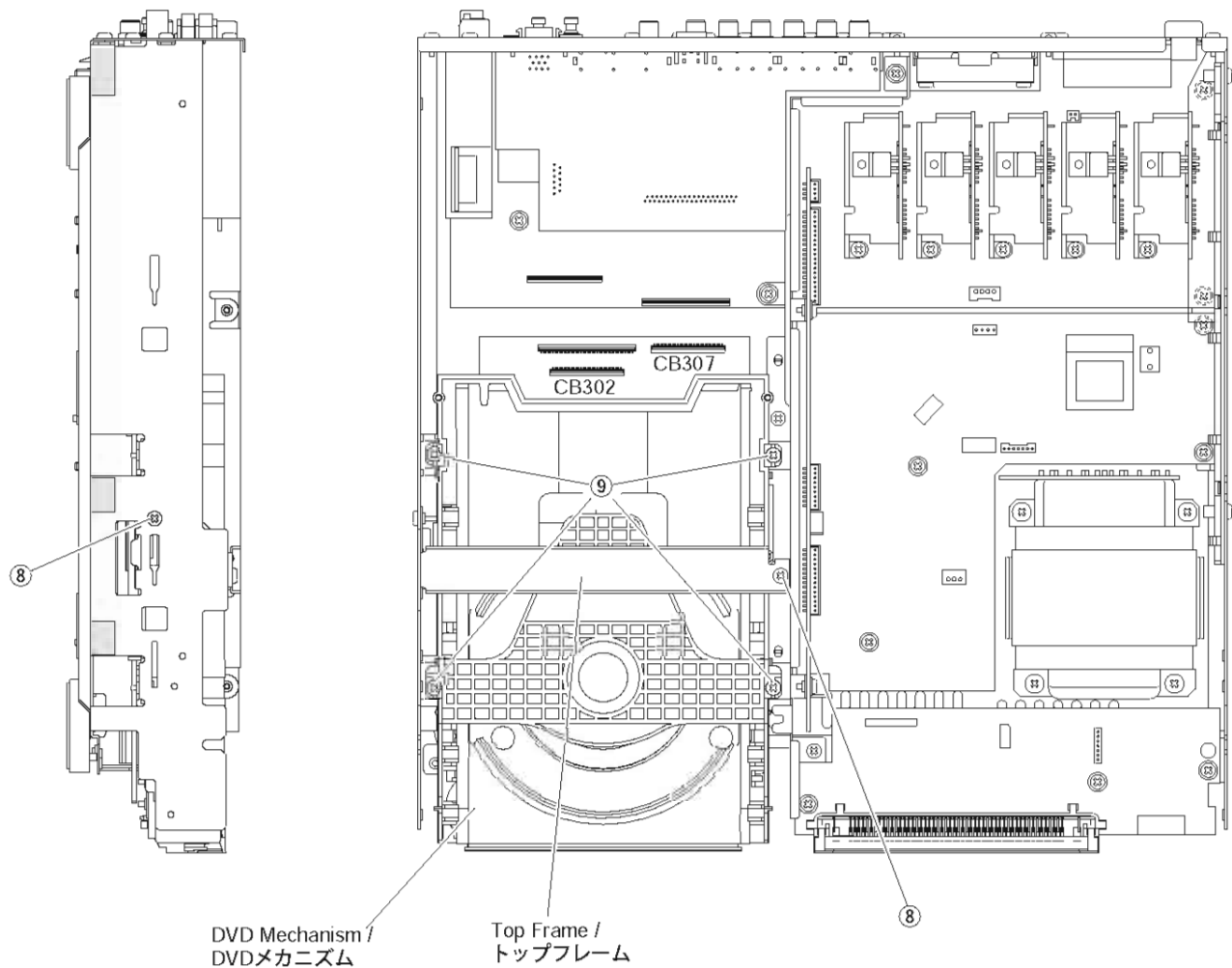

Fig. 5

DVR-S200/NX-P200

5. Removal of DIGITAL P.C.B.

- a. Disconnect the connectors CB305, CB103, CB106, CB366 and CB941 in Fig. 6.
- b. Remove 4 screws (⑩) and then remove the DIGITAL P.C.B. in Fig. 6.

Note :

When the DIGITAL P.C.B. has been removed from the main chassis, the ground connection becomes open. Connect the ground of the DIGITAL P.C.B. (G301, G303) to the chassis by using a lead wire.

5. DIGITAL P.C.B.の外し方

- a. コネクターCB305、CB103、CB106、CB366、CB941を外します。(Fig. 6)
- b. ⑩のネジ4本を外し、DIGITAL P.C.B.を外します。(Fig. 6)

注意

シャーシからDIGITAL P.C.B.を外した場合、アースが浮いて動作しませんので、DIGITAL P.C.B. (G301, G303)のアースをリード線等にてシャーシに接続してください。

6. Removal of D-Amp Module

Remove 5 screws (⑪) and then remove the D-Amp Modules in Fig. 6.

6. D-アンプモジュールの外し方

- ⑪のネジ5本を外し、D-アンプモジュールを外します。(Fig. 6)

7. Removal of FL P.C.B.

- a. Disconnect the connectors CB644 and CB945 in Fig. 6.
- b. Remove 3 screws (⑫) and 1 push rivet (⑬) and then remove the FL P.C.B. in Fig. 6.

7. FL P.C.B.の外し方

- a. コネクターCB944、CB945を外します。(Fig. 6)
- b. ⑫のネジ3本、⑬のプッシュリベット1本を外し、FL P.C.B.を外します。(Fig. 6)

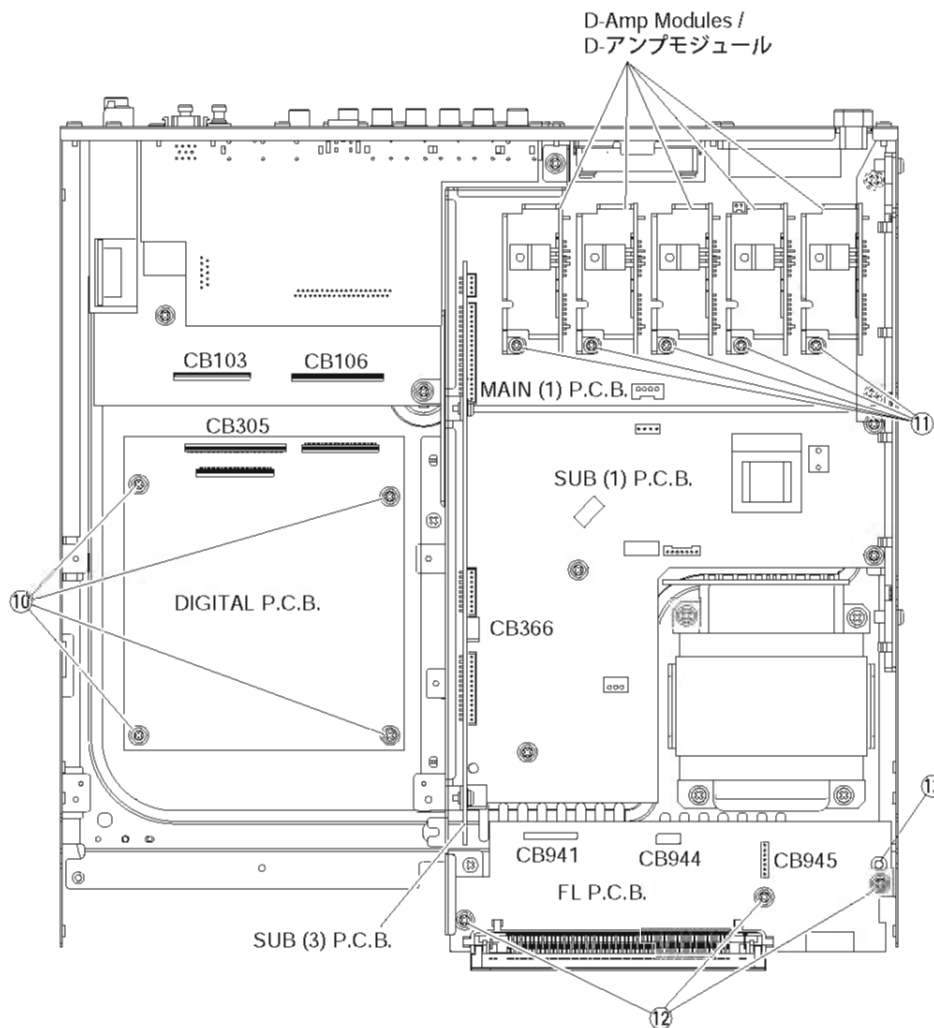

Fig. 6

8. Removal of SUB (3) & SUB (1) P.C.B.

- a. Remove 2 screws (14) in Fig. 7.
- b. Remove 2 screws (15) and 2 screws (16) and then remove the Shield in Fig. 7.
- c. Remove the SUB (3) P.C.B. in Fig. 7.
- d. Remove 2 screws (17) and 2 screws (18) in Fig. 7.
- e. Disconnect the connectors CB3, CB4, CB6, CB7, CB8, CB101 and CB118 in Fig. 7.
- f. Remove the SUB (1) P.C.B. in Fig. 7.

Note :

When the SUB (1) P.C.B. has been removed from the main chassis, the ground connection becomes open. Connect the ground of the SUB (1) P.C.B. (G3) to the chassis by using a lead wire.

8. SUB (3) & SUB (1) P.C.B.の外し方

- a. 14のネジ2本を外します。(Fig. 7)
- b. 15のネジ2本、16のネジ2本を外し、シールドを外します。(Fig. 7)
- c. SUB (3) P.C.B.を外します。(Fig. 7)
- d. 17のネジ2本、18のネジ2本を外します。(Fig. 7)
- e. コネクターCB3、CB4、CB6、CB7、CB8、CB101、CB118を外します。(Fig. 7)
- f. SUB (1) P.C.B.を外します。(Fig. 7)

注意

シャーシからSUB (1) P.C.B.を外した場合、アースが浮いて動作しませんので、SUB (1) P.C.B. (G3)のアースをリード線等にてシャーシに接続してください。

9. Removal of MAIN P.C.B.

- a. Remove 2 screws (19) and then remove the Power Cable Support in Fig. 7.
- b. Remove 1 screw (20) and 2 screws (21) in Fig. 7.
- c. Remove 3 screws (22) in Fig. 7.
- d. Remove the MAIN P.C.B. with the Rear Panel attached to it in Fig. 7.

9. MAIN P.C.B.の外し方

- a. 19のネジ2本を外し、パワーコードサポートを外します。(Fig. 7)
- b. 20のネジ1本、21のネジ2本を外します。(Fig. 7)
- c. 22のネジ3本を外します。(Fig. 7)
- d. リアパネルが付いた状態でMAIN P.C.B.を外します。(Fig. 7)

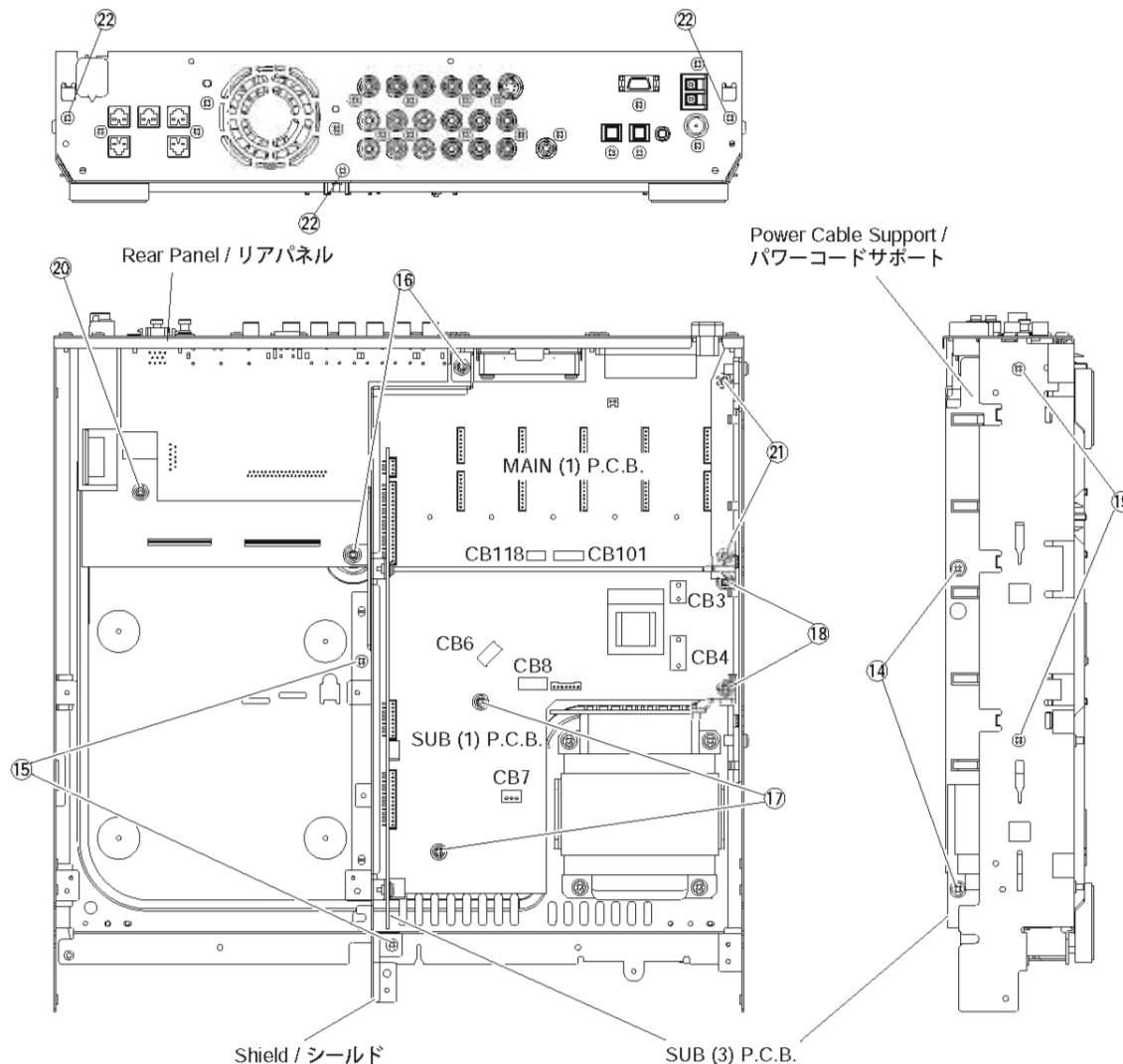

Fig. 7

■ NX-SW200 DISASSEMBLY PROCEDURES / NX-SW200分解手順

(Remove parts in disassembly order as numbered.)

(番号順に部品を取り外してください。)

1. Removal of Driver

- a. Remove 3 screws (①) and then remove the Base. (Fig. 1)
- b. Remove 4 screws (②) and then remove the Driver. (Fig. 1)
- c. Disconnect the connector connected to the terminal of the Driver.

1. スピーカーユニットの外し方

- a. ①のネジ3本を外し、ベースを取り外します。(Fig.1)
- b. ②のネジ4本を外し、スピーカーユニットを取り外します。(Fig.1)
- c. スピーカーユニットの端子に接続されているコネクタを外します。

2. Removal of Rear Panel

Remove 12 screws (③) in Fig. 2.

* **Arrow marks (⇒) are printed to identify the screws to be removed.**

* **When assembling the Rear Panel, check to ensure that the packing is not damaged so as to prevent air leakage from occurring.**

2. リアパネルの外し方

③のネジ12本を外し、リアパネルを取り出します。(Fig. 2)

* 取り外すネジの箇所には矢印(マーク)が印刷されています。

* 組み立ての際は、パッキングの損傷など無いことを確認し、エアリークが発生しないように組み立ててください。

● Bottom view

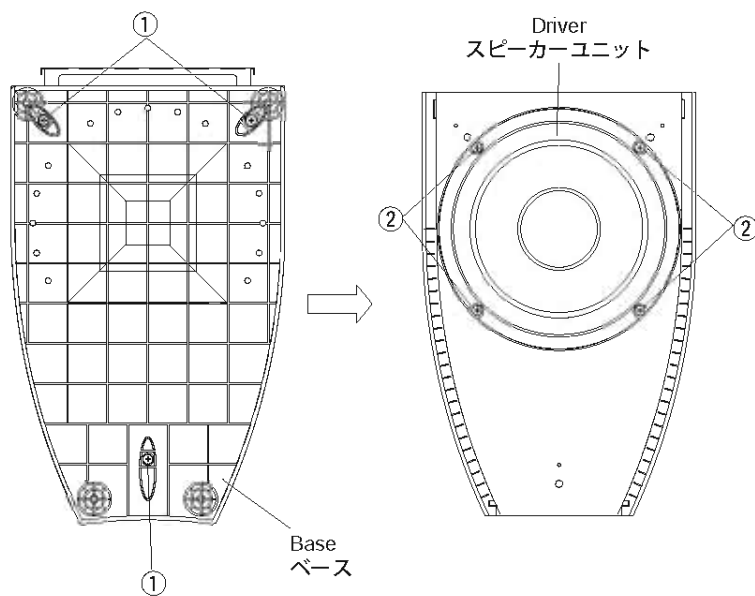

Fig. 1

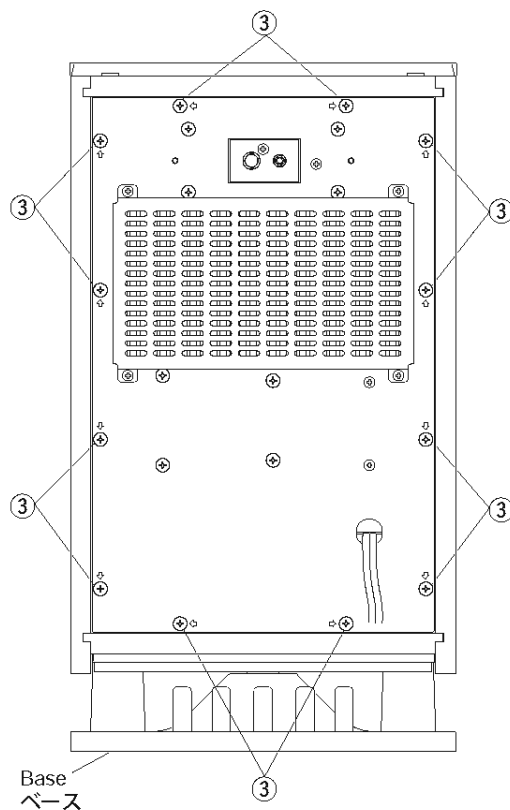

Fig. 2

When checking the P.C.B.:

Turn on the power to NX-SW200 according to the following procedure.

- a. Short between the terminals of RY2 (relay).
- b. Connect the power cable to the AC power outlet.

P.C.B.動作チェックをする場合

下記の方法により NX-SW200 に電源を投入します。

- a. RY2(リレー)の端子間をショートします。
- b. 電源コードを AC 電源コンセントに接続します。

MAIN (2) P. C. B.

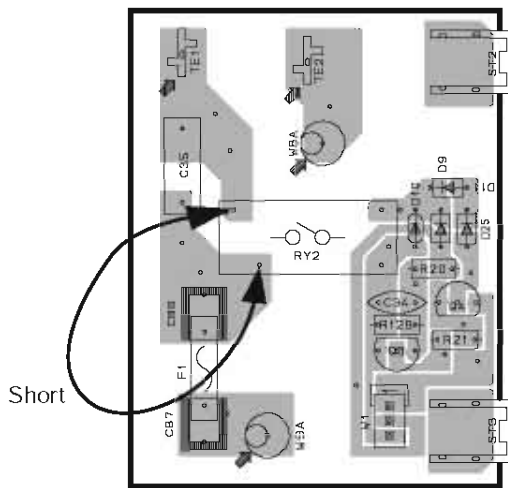

Short between these terminals for the P.C.B. check.

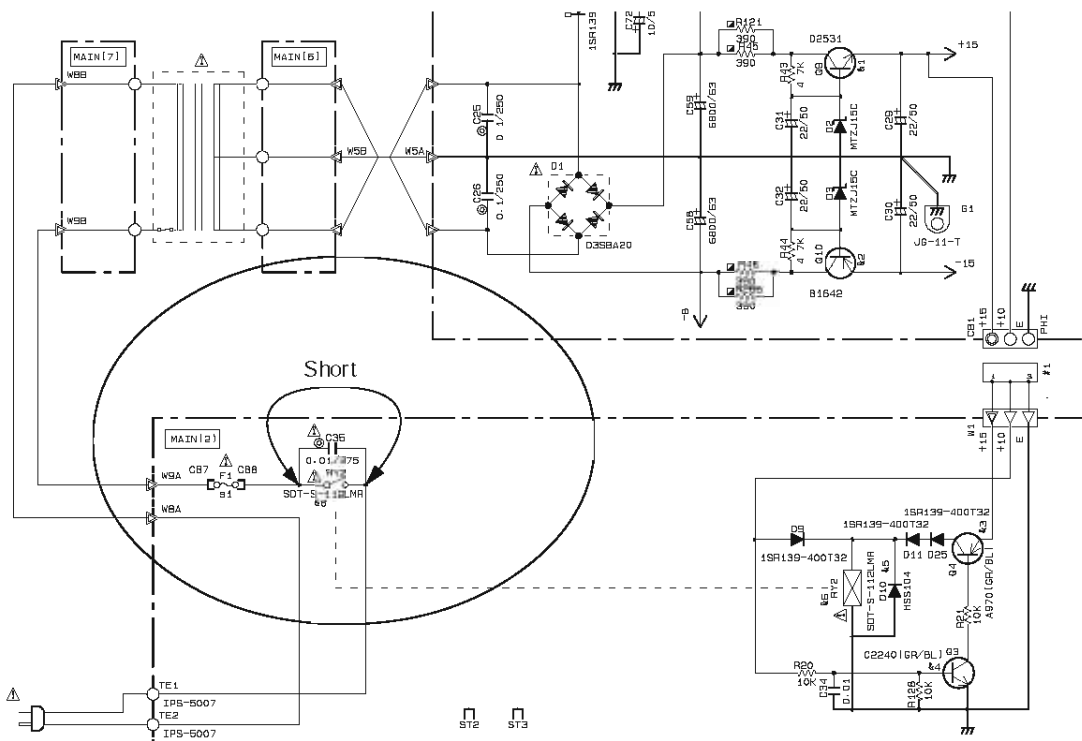

■ DVR-S200 D-AMP MODULE TROUBLESHOOTING /

DVR-S200 D-アンプモジュールの故障診断

When there is a possibility of the D-Amp Module being defective, use the following procedure to determine whether or not it is defective.

Step 1

With the power turned off, remove one D-Amp Module and then turn on the power to the main unit.

If the protection function still works, turn off the power, remove another D-Amp Module and then turn on the power to the main unit. Repeat this procedure until the protection function stops working.

Step 2

When the protection function has stopped working, install the removed D-Amp Modules one by one to the main unit and then turn on the power.

If the protection function does not work, the D-Amp Module installed then can be judged as normal.

If the protection function works, on the other hand, the D-Amp Module installed then can be judged as defective.

Repeat this procedure to check all the removed D-Amp Modules.

Caution

Note that there is a rare case where two or more D-Amp Modules are defective.

D-アンプモジュールの故障が疑われる場合、下記の方法により各D-アンプモジュールの故障の有無を判定します。

Step 1

電源OFF状態でD-アンプモジュール1個を取り外した後、本機の電源をONします。

まだプロテクションが動作する場合、電源をOFFし、更にD-アンプモジュール1個を取り外した後、本機の電源をONします。プロテクションが動作しなくなるまでこれを繰り返します。

Step 2

プロテクションが動作しなくなったら、取り外したD-アンプモジュールを1個ずつ本機に取り付け電源をONします。

プロテクションが動作しない場合、その取り付けしたD-アンプモジュールは正常と判断できます。

プロテクションが動作する場合、その取り付けしたD-アンプモジュールは故障していると判断できます。

この方法により取り外した全てのD-アンプモジュールの故障の有無を判定します。

注意

稀に2個以上のD-アンプモジュールが故障している場合があるので注意が必要です。

■ DVR-S200 ADJUSTMENT / DVR-S200調整

■ Condition

- ・ Start adjustment 5 sec or more after the power is turned on.
- ・ Headphones are not plugged in.
- ・ No input signal.

■ DC Offset Adjustment

Adjust the potentiometer on each D-Amp Module so that the DC voltage becomes $0 \pm 10 \text{ mV}$ at each speaker output.

■ 条件

- ・ 電源を入れてから5秒間以上経過後に調整を始めます。
- ・ ヘッドホンは差し込みません。
- ・ 無信号

■ DC オフセット調整

各スピーカー出力端子のDC電圧が $0 \pm 10 \text{ mV}$ になるように、各D-アンプモジュールの半可変VRを調整します。

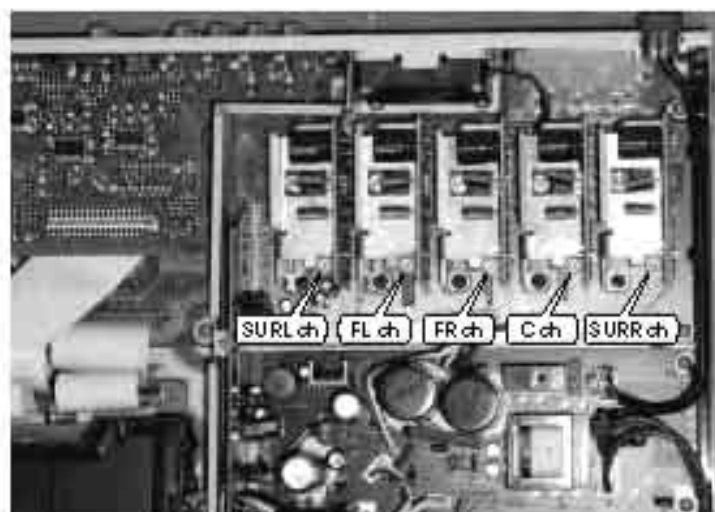

■ DVR-S200 SELF DIAGNOSIS FUNCTION (DIAG) / DVR-S200自己診断機能(ダイアグ)

This product has a built-in self diagnosis function (DIAG) to facilitate inspection, measurement and determination of a faulty item, if any. There are 14 DIAG menu items, each having sub-menu items.

Listed in the table below are menu items and sub-menu items. (Start-up and operation of DIAG menu are executed by using the main unit.)

本機には、検査、測定、不良個所の発見を目的にした自己診断機能(ダイアグ)があります。

ダイアグメニューは14個あり、そのそれぞれにサブメニューがあります。

下表はメニュー一覧です。

(ダイアグのメニュー操作は本体で行います。)

No.	DIAG menu	Sub-menu
1	DSP THROUGH	1. ANALOG BYPASS
		2. YSS 0dB
		3. YSS Front 0dB
		4. YSS FULL BIT
		5. YSS FULL BIT F
2	RAM THROUGH	RAM 0dB
3	PRO LOGIC /	1. PRO LOGIC I
		2. PRO LOGIC II
4	SPEAKERS SET	1. MAIN: SMALL 0dB
		2. CENTER: NONE
		3. LFE/BASS: MAIN
		4. Front Mix: 5ch
5	MARGIN CHECK	1. MAIN 12 dB margin
		2. MAIN 18 dB margin
6	DISPLAY CHECK	1. VFD CHECK (Initial display / 初期表示)
		2. VFD DISP OFF (All segments OFF / 全セグメント消灯)
		3. VFD DISP ALL (All segments ON 100% / 全セグメント点灯 100%)
		4. VFD DIMMER (All segments ON 50% / 全セグメント点灯 50%)
		5. CHECKED PATTERN (ON in lattice / 格子状点灯)
7	MANUAL TEST	1. TEST ALL
		2. TEST FRONT L
		3. TEST CENTER
		4. TEST FRONT R
		5. TEST SUR. R
		6. TEST SUR. L
		7. TEST LFE
8	FACTORY PRESET	1. PRESET INHIBITED (memory initialization inhibited / メモリーの初期化禁止)
		2. PRESET RESERVED (memory initialized / メモリーの初期化)
9	AD DATA CHECK /FAN TEST	1. PS (protection)
		2. PANEL KEY
		3. FAN OUT/THM
		4. FAN DRIVE TEST: HIGH
		5. FAN DRIVE TEST: MID
		6. FAN DRIVE TEST: LOW
10	IF STATUS	1. INSIDE STATUS 1
		2. INSIDE STATUS 2
		3. INSIDE STATUS 3
		4. CHANNEL STATUS 1
		5. CHANNEL STATUS 2
		6. CHANNEL STATUS 3
		7. CHANNEL STATUS 4
		8. CHANNEL STATUS 5

DVR-S200/NX-P200

No.	DIAG menu	Sub-menu
		9. BSI (YSS) 1
		10. BSI (YSS) 2
		11. BSI (YSS) 3
		12. BSI (YSS) 4
		13. BSI (CS) 1
		14. BSI (CS) 2
		15. BSI (CS) 3
		16. BSI (CS) 4
		17. BSI (CS) 5
		18. YSS938-1
		19. YSS938-2
		20. YSS938-3
		21. CS49329
		22. Mute Trigger
11	DSP RAM CHECK	1. YSS938 BUS CHECK
		2. PLD/CS BUS CHECK
12	SOFT SWITCH	1. SW MODE: PCB/SOFT
		2. MODEL SETTING
		3. TUNER DESTINATION
		4. TUNER EXIST
		5. RDS EXIST
		6. VIDEO FORMAT
13	ROM VERSION/CHECK SUM/ PORT	1. VERSION
		2. CHECK SUM ALL
		3. PORT
		4. AAC PORT
14	ROM CORRECTION/ CHECK SUM	1. SOFT DATE
		2. ROM CORRECTION: EXIST/NOT
		3. ROM CORRECTION CHECK SUM DISP
		4. ROM CORRECTION REMOCON RECEIVE
		5. REMOCON CODE DISP
		6. Protection History
		7. UCD CLOCK LOW/HIGH
		8. ASPECT Lo/Mid/Hi

● Starting DIAG

While pressing the "A/B/C/D/E" key on the main unit, press the "STANDBY/ON" key until the FL display lights up. Within 4 seconds after that, press the "PRESET/BAND" key to start the DIAG function.

● ダイアグの起動

本体の"A/B/C/D/E"キーを押しながら"STANDBY/ON"キーを押し、表示点灯後4秒以内に"PRESET/BAND"キーを押すとダイアグが起動します。

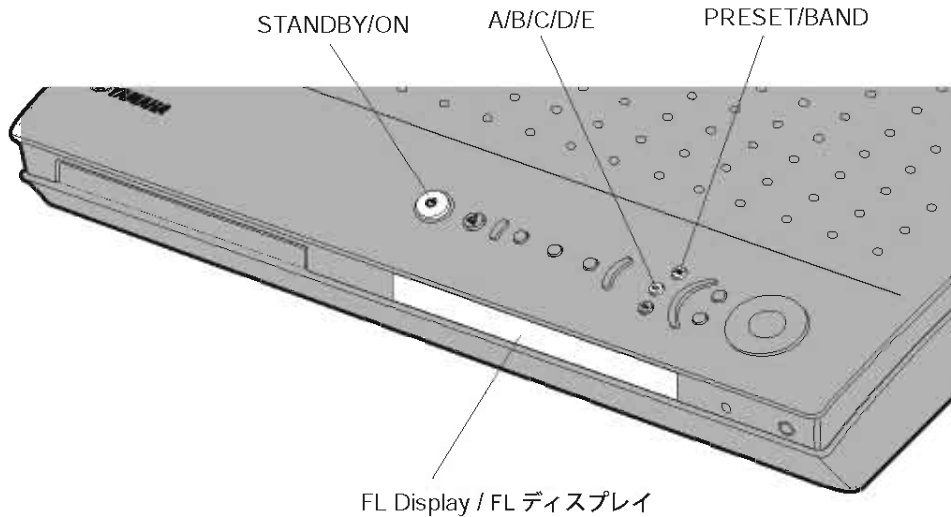

* In the DIAG mode, all the protection functions other than the excess current detect function are canceled, and the "SLEEP" segment of the FL display of the main unit flashes. Please note, therefore, that no protection function works even when a dangerous situation occurs while using the DIAG mode.

※ ダイアグモードでは過電流検出以外のプロテクション動作が解除されます。
このモードでは本体FLディスプレイの"SLEEP"が点滅します。
以後、ダイアグ中、危険な状態でもプロテクション動作が働きませんので注意してください。

● Canceling DIAG

1 Before canceling DIAG, execute setting for PRESET of DIAG menu No.8 (Memory initialization inhibited or Memory initialized).

* In order to keep the user memory stored, be sure to select PRESET INHIBITED (Memory initialization inhibited). Protection history will remain in memory.

2 Turn off the power by pressing the "STANDBY/ON" key of the main unit.

● ダイアグの解除

1 ダイアグを解除する前に、ダイアグメニューNo.8のFACTORY PRESET (メモリーの初期化禁止/またはメモリーの初期化)の設定をします。

※ ユーザーメモリーを保持したい場合は、必ずPRESET INHIBITED (メモリー初期化禁止)を選択してください。

2 本体の"STANDBY/ON"キーを押し、パワーオフにします。

DVR-S200/NX-P200

● Display provided when DIAG started

On the FL display of the main unit, an opening message (including the version and the protection history) appears for a few seconds followed by the diagnostic menu display of ANALOG BYPAS.

● ダイアグ起動時の表示

本体FLディスプレイには、オープニング(プロテクション履歴/バージョン)が表示され、数秒後にダイアグメニュー表示(ANALOG BYPAS)となります。

When there is no history of protection function:

プロテクション履歴が無い場合:

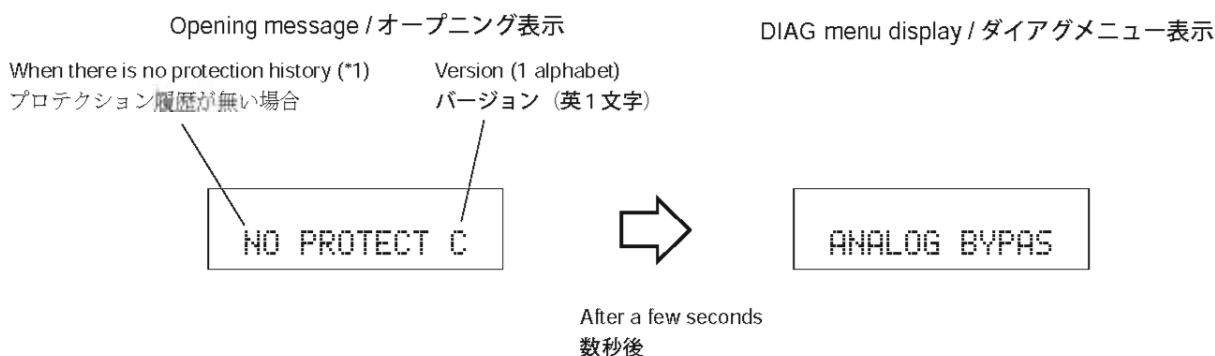

When there is a history of protection function:

The FL display appears as shown below depending on the type of the protection function.

プロテクション履歴がある場合:

プロテクションの種類によって下記の表示が現れます。

The protection function worked due to excessive current through the amplifier. Causes could be a short at the speaker terminal or a defect in the amplifier.

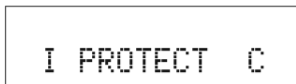

スピーカーをショートさせた時などが原因で、プロテクションが働いたことを示します。

The protection function worked due to a DC voltage appearing at the speaker terminal. A cause could be a defect in the amplifier.

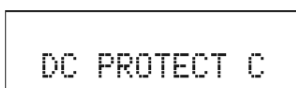

アンプの故障でスピーカーに直流電圧が掛かるなどが原因で、プロテクションが働いたことを示します。

The protection function worked due to an AC overload. A cause could be a shorted secondary wire of the transformer.

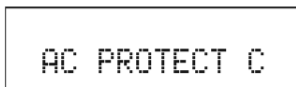

トランスの二次巻き線がショートしたときなどが原因で、プロテクションが働いたことを示します。

The protection function worked due to the temperature limit being exceeded. Causes could be poor ventilation or a defect related to the thermal sensor.

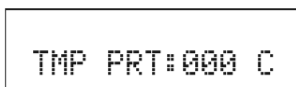

温度制限を越えた原因で、プロテクションが働いたことを示します。

The protection function worked due to a defect or overload in the power supply (but not related to the DVD). If the power is turned on with the abnormality unsolved, the protection function works in about 1 second to turn off the power.

```
PS PRT:000 C
```

電源(DVD関連以外)による原因で、プロテクションが働いたことを示します。異常状態のままパワーオンすると、約1秒後にプロテクションが掛かり、電源が切れます。

The protection function worked due to a defect or overload in the DVD power supply. If the power is turned on with the abnormality unsolved, the protection function works in about 1 second to turn off the power.

```
PS2 PRT:000 C
```

電源(DVD関連)による原因で、プロテクションが働いたことを示します。異常状態のままパワーオンすると、約1秒後にプロテクションが掛かり、電源が切れます。

TMP PRT, PS PRT and PS2 PRT displays include the abnormal A/D value in %. Concerning this value, refer to DIAG menu No.9 AD DATA CHECK described on page 38.

TMP PRT表示、PS PRT表示、PS2 PRT表示には、異常状態のA/D値を%表示します。

この値に関しては、後述のダイアグメニューNo. 9 AD DATA CHECK(38ページ)を参照してください。

● History of protection function

When the protection function has worked, its history is stored in memory with a backup. Even if no abnormality is noted while servicing the unit, an abnormality which has occurred previously can be defined as long as the backup data has been stored.

The history of the protection function is cleared when DIAG is cancelled by selecting PRESET RESERVED (Memory initialized) of DIAG menu No.8 or by selecting Prt Hist < DEL (Protection history deletion reserved) of sub-menu 6 of DIAG menu No.14 and the backup data is erased.

● プロテクションの履歴

プロテクションが働いた場合、履歴をバックアップして記憶しています。サービスのときに異常が認められなくても、バックアップが残っていれば、お客様のところで起きた異常を区別できます。ダイアグメニューNo.8で PRESET RESERVED (メモリーの初期化)を選んでダイアグを解除した場合、またはダイアグメニューNo.14のサブメニュー6で Prt Hist < DEL (プロテクション履歴削除の予約)を選んでダイアグ解除した場合、またはバックアップが消えた場合に、プロテクションの履歴はクリアされます。

● Display during menu operation

During the DIAG operation, the function at work is indicated on the FL indicator. The contents displayed during the function operation are shown for each step.

● メニュー動作中の表示

ダイアグ中、本体のFLディスプレイに動作中の機能が表示されます。機能動作中の表示内容については、後述の機能詳細で記述します。

DVR-S200/NX-P200

● Operation procedure of DIAG menu and SUB-MENU

There are 14 MENU items and some SUB-MENU items as well.

DIAG menu selection

Main unit: PRESET TUNING ∨(forward)/∧(reverse) key

SUB-MENU selection

Main unit: DSP (forward) key

● ダイアグメニューとサブメニューの操作

ダイアグにはNo.1～14のメニューがあり、さらにいくつかのサブメニューがあります。

ダイアグメニューの選択

本体 : PRESET TUNING ∨(順送り)/∧(逆送り)キー

サブメニューの選択

本体 : DSP(順送り)キー

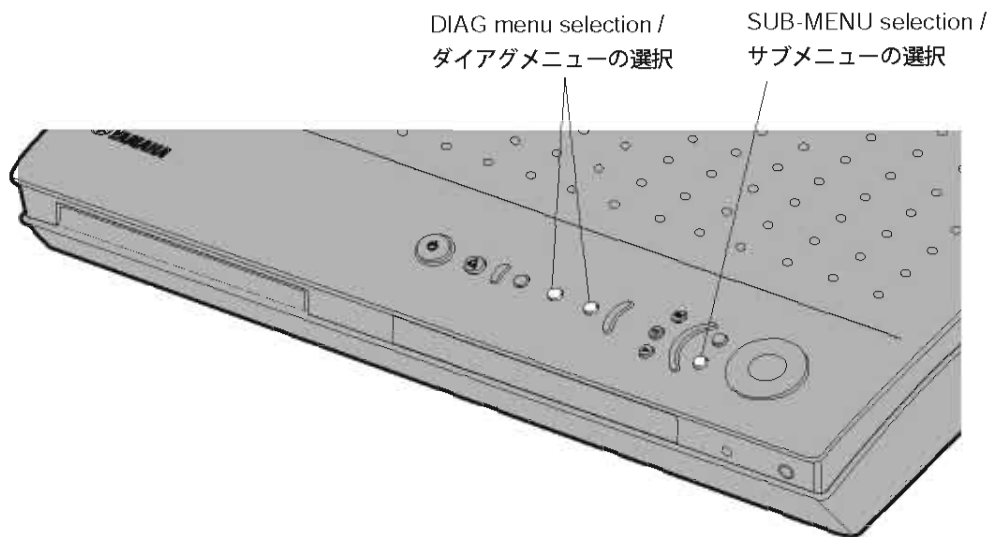

● Functions available during DIAG

In addition to the DIAG menu, the functions listed below are available:

- Input selection
- Center/Surround/Sub-woofer level adjustment
- Muting
- Power on/off operation
- Master volume
- * **Functions related to the tuner and the set menu are not available.**
- * **It is possible to confirm Menu No.10 "IF STATUS" while keeping the signal process (operation status) of each DIAG menu by using the INPUT MODE key of the main unit.**

● Initial settings used to start DIAG function

The following initial settings are used when starting the DIAG function:

(When the DIAG function is canceled, the settings before starting DIAG will be restored.)

- Input: VIDEO 1 (U, C, R, K, A, L) or VIDEO (B, G)
- Master volume: 56 (-40dB)
- Effect level: 0dB
- Audio mute: OFF
- Speaker settings: LARGE /BASS OUT = BOTH
- DIAG menu: ANALOG BYPASS

● ダイアグ中の機能

ダイアグメニューの他に以下の機能が動作します。

- インプット切り換え
- センター/サラウンド/サブウーファーレベル調整
- ミューティング
- パワーオン・オフ操作
- マスターボリューム

* チューナー関連、セットメニュー関連は機能しません。

* 本体INPUTモードキーにより、各ダイアグメニューの信号処理(動作状態)を維持したままメニューNo. 10 "IF STATUS"の確認ができます。

● ダイアグ開始時の初期設定

ダイアグ開始時の初期設定は、下記の設定になります。また、これらの設定は、ダイアグ解除時にはダイアグ開始前の状態に戻ります。

- インプット : VIDEO 1
- マスターボリューム : 56 (-40dB)
- エフェクトレベル : 0dB
- オーディオミュート : オフ
- スピーカー設定 : LARGE / BASS OUT = BOTH
- ダイアグメニュー : ANALOG BYPASS

Details of DIAG menu

With full-bit output specified in some modes, it is possible to execute 0dBFS output without head margin in each channel.

1. DSP THROUGH

Main DSP of YSS938 is selected for MAIN L/R output.

ANALOG BYPASS

- The signal for L/R is output as it is without passing through the DSP section.

ANALOG BYPAS

Input level	Volume	SPEAKERS OUT (1KHz)			SUBWOOFER (50 Hz)
		FRONT L/R	CENTER	SURROUND L/R	
Both ch, -20 dBm	-10 dB (90)	+20.5 dBm	- ∞	- ∞	- ∞

YSS 0dB

- The signal is output including the head margin.
Head margin:
Main L/R: 0dBFS, Center: 0dBFS,
RL/RR: -12dBFS, SWFR: Add L/R signal at -20dBFS.

YSS 0dB

Input level	Volume	SPEAKERS OUT (1KHz)			SUBWOOFER (50 Hz)
		FRONT L/R	CENTER	SURROUND L/R	
Both ch, -20 dBm	-10 dB (90)	+20.5 dBm	+20.2 dBm	+20.0 dBm	+5.0 dBm

YSS Front 0dB

- The front CH signal including the head margin is output at the main CH.
Head margin:
Main L/R: 0dBFS, Center: 0dBFS,
RL/RR: -12dBFS, SWFR: Add L/R signal at -20dBFS.

YSS Front0dB

Input level	Volume	SPEAKERS OUT (1KHz)			SUBWOOFER (50 Hz)
		FRONT L/R	CENTER	SURROUND L/R	
Both ch, -20 dBm	-10 dB (90)	+20.5 dBm	- ∞	- ∞	- ∞

ダイアグメニュー詳細

一部のモードでフルビット指定することで、各チャンネルのヘッドマージンを廃して0dBFS出力することが可能です。

1. DSP THROUGH

MAIN L/R出力には YSS938 の Main DSP が選択されます。

ANALOG BYPASS

- L/Rは、DSP 部を通らずにそのまま出力されます。

YSS 0dB

- ヘッドマージンを含んで出力されます。
ヘッドマージン：
Main L/R: 0dBFS、Center: 0dBFS、
RL/RR: -12dBFS、SWFR: L/Rを-20dBfsにて加算

YSS Front 0dB

- ヘッドマージンを含んでフロントCHをメインCHに出力されます。
ヘッドマージン：
Main L/R: 0dBFS、Center: 0dBFS、
RL/RR: -12dBFS、SWFR: L/Rを-20dBfsにて加算

DVR-S200/NX-P200

YSS FULL BIT

- The signal is output in digital full bit without including the head margin. The SWFR signal is output but not in digital full bit.

YSS FULL BIT

- ヘッドマージンを含まず、デジタルフルビットで出力されます。SWFRは出力されますが、デジタルフルビットではありません。

YSS FULL BIT

Input level	Volume	SPEAKERS OUT (1KHz)			SUBWOOFER (50 Hz)
		FRONT L/R	CENTER	SURROUND L/R	
Both ch, -20 dBm	-10 dB (90)	+20.5 dBm	+20.2 dBm	+20.0 dBm	+5.0 dBm

YSS FULL BIT F

- The front CH signal is output in digital full bit at the main CH.

YSS FULL BIT F

- フロントCHがメインCHに、デジタルフルビットで出力されます。

FULL BIT F

Input level	Volume	SPEAKERS OUT (1KHz)			SUBWOOFER (50 Hz)
		FRONT L/R	CENTER	SURROUND L/R	
Both ch, -20 dBm	-10 dB (90)	+20.5 dBm	- ∞	- ∞	- ∞

DSP THROUGH
YSS (Analog)

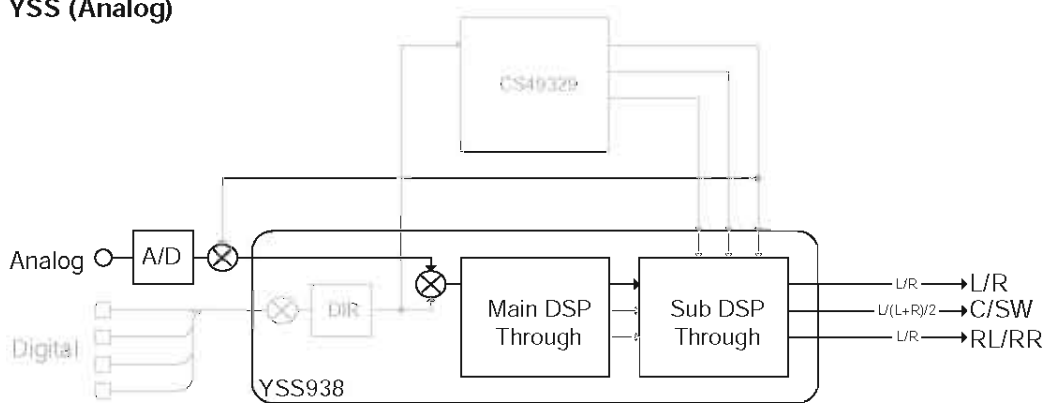

(Shaded items not used in this example)

2. RAM THROUGH

This function is for YSS938 only.
Only the CT signal is output through the Sub DSP – DRAM.

2. RAM THROUGH

YSS938 のみの動作です。
CTのみが Sub DSP – DRAM 経由で出力されます。

RAM 0dB

RAM 0dB

RAM 0dB

Input level	Volume	SPEAKERS OUT (1KHz)			SUBWOOFER (50 Hz)
		FRONT L/R	CENTER	SURROUND L/R	
Both ch, -20 dBm	-10 dB (90)	- ∞	+20.2 dBm	- ∞	- ∞

**RAM THROUGH
(Auto)**

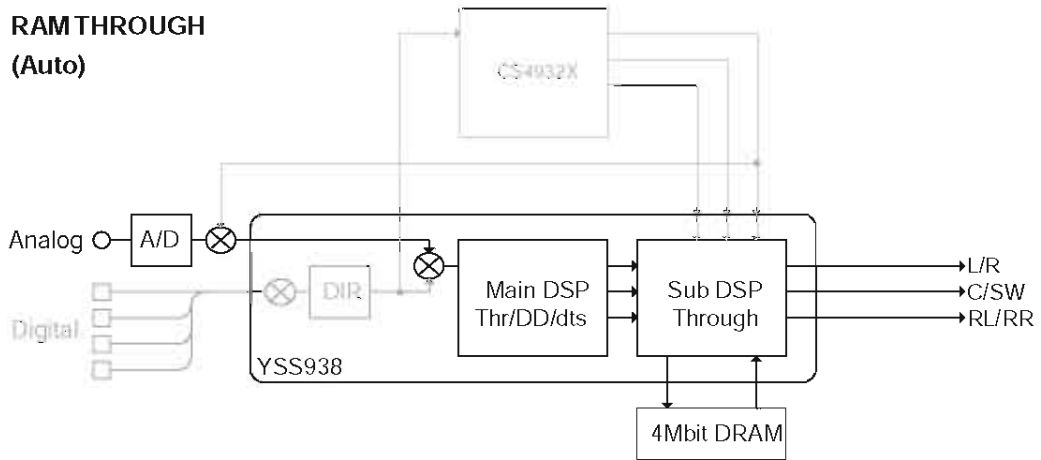

(Shaded items not used in this example)

DVR-S200/NX-P200

3. PRO LOGIC

The L/C/R/RL/RR signals undergo the Pro-Logic processing and C/RL/RR signals are output through Sub DSP-DRAM. Main DSP is selected for MAIN L/R output.

Using the sub-menu, it is possible to select PRO LOGIC I, II (Movie). The Auto Input Balance function is always off.

When the Dolby Digital Multi input is used, the function is the same as in the Dolby Digital Normal mode.

The LFE signal is not output when decoding in the PRO LOGIC I, II mode.

3. PRO LOGIC

L/C/R/RL/RR は YSS938 によりプロロジック処理され、C/RL/RR は Sub DSP - DRAM 経由で出力されます。MAIN L/R 出力には Main DSP が選択されます。

サブメニューでPRO LOGIC I, II (Movie) を選択可能です。常時 Auto Input Balance off です。

AAC 入力時は CS49329 でデコード後、L/R はプロロジック処理されます。(J model のみ)

Dolby Digital Multi 入力時は、通常の Dolby Digital Normal と同じ動作をします。

PRO LOGIC I, II デコード時は、LFE は出力されません。

PRO LOGIC I

PRO LOGIC I

PRO LOGIC I

Input level	Volume	SPEAKERS OUT (1KHz)			SUBWOOFER (50 Hz)
		FRONT L/R	CENTER	SURROUND L/R	
Each ch, -20 dBm	-10 dB (90)	+20.5 dBm	- ∞	- ∞	- ∞
Both ch, -20 dBm	-10 dB (90)	- ∞	+23.0 dBm	- ∞	- ∞

PRO LOGIC II

PRO LOGIC II

PRO LOGIC II

Input level	Volume	SPEAKERS OUT (1KHz)			SUBWOOFER (50 Hz)
		FRONT L/R	CENTER	SURROUND L/R	
Each ch, -20 dBm	-10 dB (90)	+17.5 dBm	- ∞	- ∞	- ∞
Both ch, -20 dBm	-10 dB (90)	- ∞	+23.0 dBm	- ∞	- ∞

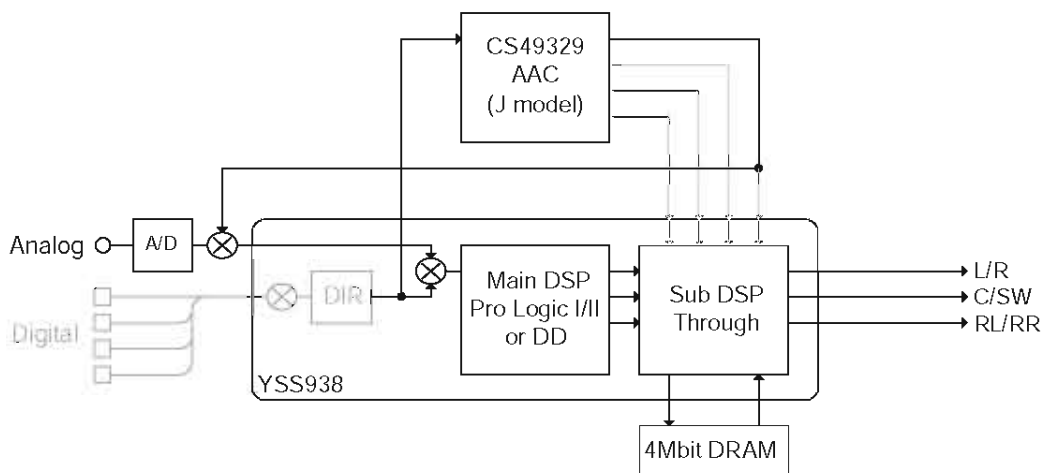

(Shaded items not used in this example)

4. SPEAKERS SET

The input signal is automatically identified and switched in the priority order of dts →DOLBY DIGITAL → AAC → PCM AUDIO → Analog (A/D) according to the signal detection. The signals output from the DSP block are the same as 1. DSP THROUGH: YSS 0dB.

4. SPEAKERS SET

入力は信号検出によって、dts →DOLBY DIGITAL → AAC → PCMAUDIO →アナログ(A/D)の優先順で自動判別切り換えされます。DSP部からは、No. 1 DSP THROUGHのYSS 0dBと同様の信号が出力されます。

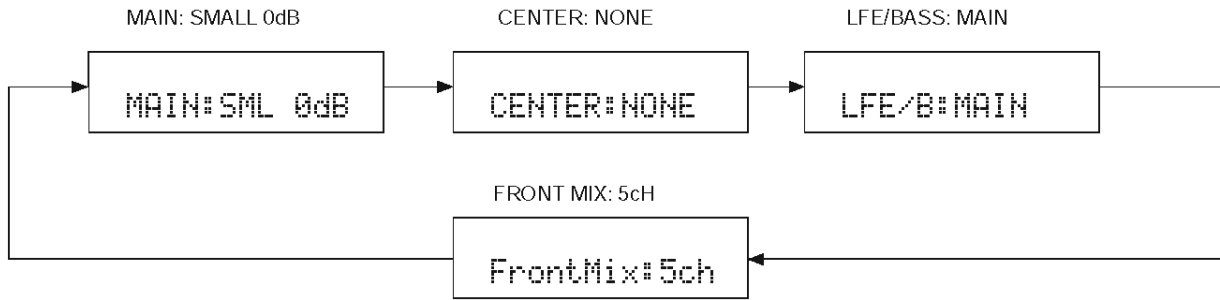

The analog switch settings for each sub-menu are as shown in the table below.

各サブメニューにおけるアナログスイッチの設定は以下の通りです。

Sub-menu	CENTER SP	REAR SP	MAIN SP	MAIN LEVEL	LFE/BASS
1 MAIN: SMALL 0dB	LARGE	LARGE	SMALL	0dB	SWFR
2 CENTER: NONE	NONE	LARGE	LARGE	0dB	BOTH
3 LFE/BASS: MAIN	SMALL	SMALL	LARGE	0dB	MAIN
4 FRONT MIX: 5cH	LARGE	LARGE	LARGE	0dB	BOTH

- LARGE: This mode is used with a speaker with high bass reproduction performance (a large unit). Full bandwidth signals are output.
- SMALL: This mode is used with a speaker with low bass reproduction performance (a small unit). The signals of 90Hz or less are mixed into the channel specified by LFE/BASS.
- NONE: This mode is used with no center speaker. The center content is reduced by 3dB and distributed to MAIN L/R.

- LARGE: 低音再生能力の高い(ユニットの大きい)スピーカーを使用するモードです。全帯域が出力されます。
- SMALL: 低音再生能力の低い(ユニットの小さい)スピーカーを使用するモードです。90Hz以下がLFE/BASSで指定したチャンネルにミックスされます。
- NONE: スピーカーを使用しないモードです。センター成分は-3dBされて、MAIN L/Rに振り分けられます。

Sub-menu	Input level	Volume	SPEAKERS OUT (1KHz)			SUBWOOFER (50 Hz)
			FRONT L/R	CENTER	SURROUND L/R	
1 MAIN: SMALL 0dB	1kHz, Both ch, -20 dBm	-10 dB (90)	+20.5 dBm	-∞	-∞	-∞
2 CENTER: NONE	1kHz, Both ch, -20 dBm	-10 dB (90)	-∞	+20.2 dBm	-∞	-∞
3 LFE/BASS: MAIN	50Hz, Both ch, -20 dBm	-10 dB (90)	-∞	-∞	-∞	-∞
4 FRONT MIX: 5cH	1kHz, Both ch, -20 dBm	-10 dB (90)	+20.5 dBm	-∞	-∞	-∞

DVR-S200/NX-P200

5. MARGIN CHECK

The signal is output including the head margin.

5. MARGIN CHECK

ヘッドマージンを含んで出力されます。

MAIN 12dB MARGIN

MAIN 12dB MARGIN

MAIN 12dB

Input level	Volume	SPEAKERS OUT (1KHz)			SUBWOOFER (50 Hz)
		FRONT L/R	CENTER	SURROUND L/R	
1kHz, Both ch, -20 dBm	-10 dB (90)	+8.5 dBm	- ∞	- ∞	- ∞

MAIN 18dB MARGIN

MAIN 18dB MARGIN

MAIN 18dB

Input level	Volume	SPEAKERS OUT (1KHz)			SUBWOOFER (50 Hz)
		FRONT L/R	CENTER	SURROUND L/R	
1kHz, Both ch, -20 dBm	-10 dB (90)	+2.2 dBm	- ∞	- ∞	- ∞

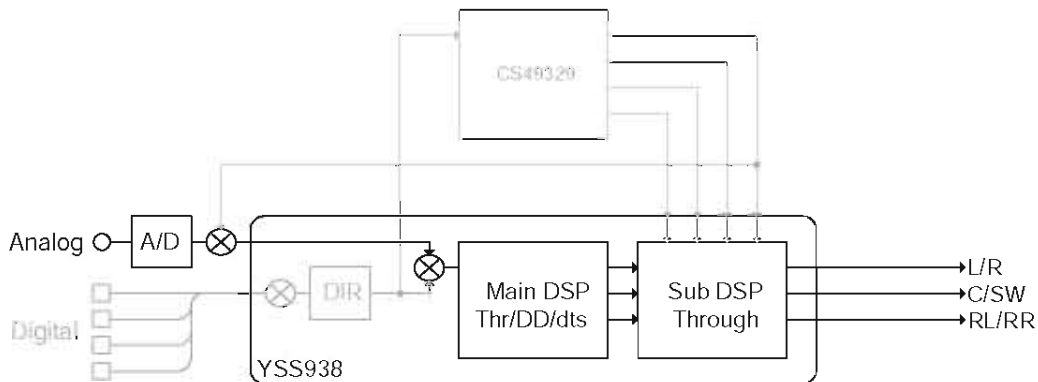

(Shaded items not used in this example)

6. DISPLAY CHECK

This program is used to check the FL display section. The display condition varies as shown below according to the sub-menu operation. The signals are processed using EFFECT OFF (The L/R signal is output using ANALOG MAIN BYPASS.)

6. DISPLAY CHECK

FL 表示部のチェックプログラムです。サブメニュー操作により、表示状態が以下のように変わります。信号処理はEFFECT OFF (ANALOG MAIN BYPASSでL/Rを出力)です。

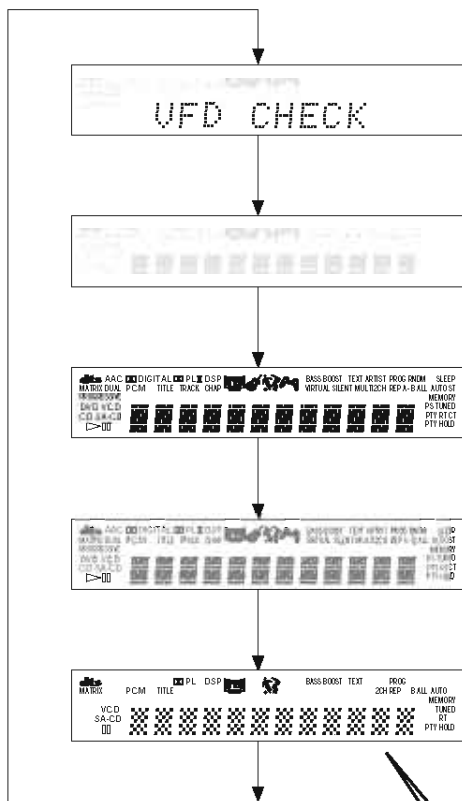

Initial display /
初期表示

All segments OFF /
全セグメント消灯

All segments ON (dimmer 100%) /
全セグメント点灯 (ディマー 100%)

All segments ON (dimmer 50%) /
全セグメント点灯 (ディマー 50%)

Lighting of segments in lattice /
セグメント格子状点灯

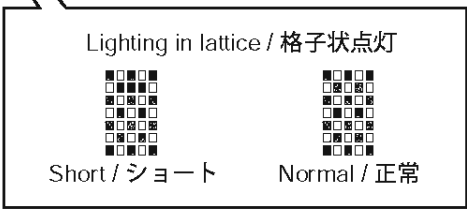

Segment conditions of the FL driver and the FL tube are checked by turning ON and OFF all segments. Next, the operation of the FL driver is checked by using the dimmer control. Then a short between segments next to each other is checked by turning ON and OFF all segments alternately (in lattice). (In the above example, the segments in the second row from the top are shorted.)

全セグメント消灯・全セグメント点灯によりFLドライバー、FL管のセグメントの不良を確認します。次に、ディマーコントロールによってFLドライバーの動作チェックを行います。さらに全セグメントを交互(格子状)に点灯/消灯することで、隣り合うセグメントのショートをチェックします。

7. MANUAL TEST

The noise generator built into the DSP outputs the test noise through the channels specified by the sub-menu.

The noise frequency for LFE is 35 to 250 Hz. Other than that, the center frequency is 800Hz.

CAUTION:

When the input is DVD/CD, no test noise is output.

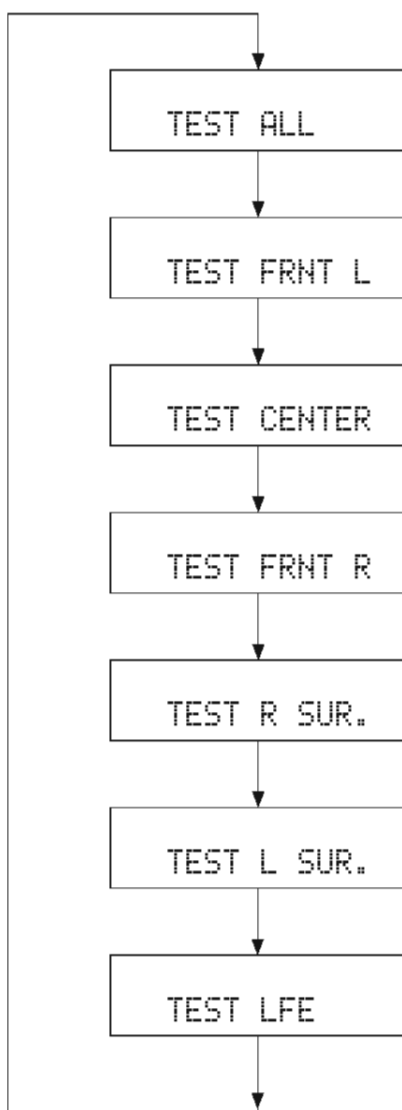

7. MANUAL TEST

DSP 内蔵のノイズ発生回路によって、サブメニューで指定したチャンネルへテストノイズを出力します。

LFE用のノイズ周波数は35～250Hz、それ以外は中心周波数800Hzとなります。

注意：InputがDVD/CDの場合、テストノイズは出力されません。

TEST ALL

Noise is output from all channels except SUB WOOFER.
SUB WOOFER以外の全チャンネルからノイズを出力

TEST FRONT L

Noise is output from the FRONT L channel.
FRONT Lチャンネルからノイズを出力

TEST CENTER

Noise is output from the CENTER channel.
CENTERチャンネルからノイズを出力

TEST FRONT R

Noise is output from the FRONT R channel.
FRONT Rチャンネルからノイズを出力

TEST R SURROUND

Noise is output from the SURROUND R channel.
SURROUND Rチャンネルからノイズを出力

TEST L SURROUND

Noise is output from the SURROUND L channel.
SURROUND Lチャンネルからノイズを出力

TEST LFE

Noise is output from the SUB WOOFER channel.
SUB WOOFERチャンネルからノイズを出力

8. FACTORY PRESET

This menu is used to reserve and inhibit initialization of the back-up RAM. The signals are processed using EFFECT OFF. (The L/R signal is output using ANALOG MAIN BY-PASS.)

8. FACTORY PRESET

バックアップ用RAM(音場プログラムのパラメーターやセットメニュー内容等)の初期化を予約/禁止します。信号処理はEFFECT OFFと同じです(ANALOG MAIN BY-PASSで、L/Rを出力)。

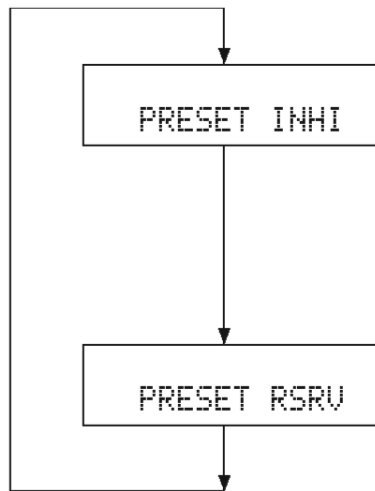

PRESET INHIBIT (Initialization inhibited) / PRESET INHIBIT (初期化禁止)

RAM initialization is not executed. Select this sub-menu to protect the values set by the user.

Note: The protection history will not be erased using PRESET INHIBIT.

RAMの初期化は行われません。ユーザーの設定値を保護するときは、こちらを選択してください。

PRESET RESERVED (Initialization reserved) / PRESET RESERVED (初期化予約)

Initialization of the back-up RAM is reserved. (Actually, initialization is executed the next time that the power is turned on.) Select this sub-menu to reset to the original factory settings or to reset the RAM. Use PRESET RESERVED to erase the protection history.

バックアップRAMの初期化が予約されます。(実際に初期化されるのは、次回の電源投入時です。)工場出荷時やRAMをリセットしたいときは、こちらを選択してください。

CAUTION: Before setting to the PRESET RESERVED, write down the existing preset memory content of the Tuner in a table as shown below. (This is because setting to the PRESET RESERVED will cause the user memory content to be erased.)

注意：PRESET RESERVEDを選んで初期化をする前に、チューナーのユーザーメモリー内容を下表に書き写してください。(初期化をすると、ユーザーメモリーの内容は消えてしまいます。)

Preset group	P1	P2	P3	P4	P5	P6	P7	P8
A								
B								
C								
D								
E								

● PRESET STATIONS / プリセット局

STATION		FM FACTORY PRESET DATA (MHz)				STATION		AM FACTORY PRESET DATA (kHz)	
PAGE	NO.	U, C	R, K, L, G, B, A	J	PAGE	NO.	U, C, R, L	A, K, G, B, J	
A/C/E	1	87.5	87.50	76.0	B/D	1	630	630	
	2	90.1	90.10	83.0		2	1080	1080	
	3	95.1	95.10	84.0		3	1440	1440	
	4	98.1	98.10	86.0		4	530	531	
	5	107.9	108.00	90.0		5	1710	1611	
	6	88.1	88.10	78.0		6	900	900	
	7	106.1	106.10	88.0		7	1350	1350	
	8	107.9	108.00	82.1		8	1400	1404	

DVR-S200/NX-P200

9. AD DATA CHECK/FAN TEST

This menu is used to display the A/D conversion value of the terminals which detect the panel keys of the main unit and protection functions in % using the sub-menu. During signal processing, the condition before execution is maintained. When K0 menu is selected, keys become non-operable due to detection of the values of all keys.

However, it is possible to advance to the next sub-menu by turning the VOLUME of the main unit. When using this function, note that turning the VOLUME more than 2 clicks will cause the volume value to change.

** The figures in the diagram are given as reference only.*

PS/PS2 (protection detection)

PS: Value of power supply voltage protection other than DVD (Normal value: 30 to 54)

P2: Value of power supply voltage protection related to DVD (Normal value: 76 to 99)

This is displayed only when the input is DVD/CD.

If PS or P2 is out of the normal value range, the protection function works to turn off the power after 1 second.

PS:057P2:055

K0 (Panel key of main unit)

A/D of the key fails to function properly when the standard value is deviated. In this case, check the constant of partial pressure resistor, solder condition, etc. Refer to table 1.

K0:100%

9. AD DATA CHECK/FAN TEST

本体パネルキー、プロテクションなどを検出している端子のA/D変換の値を、サブメニューで%表示します。信号処理は実行前の状態を維持します。

K0のメニューにすると、全キーの値を検出するためキー操作はできなくなりますが、本体のVOLUMEを回すことにより、次のサブメニューに進めることができます。このとき2クリック以上回すと、ボリューム値が変化するので注意してください。

※図中の数値は参考例です。

PS/PS2 (プロテクションの検出)

PS: DVD以外の電源電圧プロテクションの値 (正常値30～54)

P2: DVD関連の電源電圧プロテクションの値 (正常値76～99)

InputがDVD/CDの場合にのみ表示されます。

PS、P2は正常値を外れるとプロテクションが働き、電源オフされます。

K0 (本体パネルキー)

キーのA/Dは基準値から外れると、正常な動きをしません。Table 1 をご覧になり、各キーの分圧抵抗の定数、ハンダ不良等の確認をしてください。

[Table 1]

Display (%)	K0
0 - 5	STOP
6 - 15	SKIP/SEARCH -
16 - 25	SKIP/SEARCH +
26 - 35	PAUSE
36 - 45	DSP
46 - 55	INPUT
56 - 65	PLAY
66 - 75	PROGRESSIVE
76 - 85	OPEN

TH/Fa (temperature detection/fan drive level)

TH: 500% display of the voltage based on the temperature detected value. Reference voltage : 5V
(Normal value: 1 to 257)

Fa: Current fan drive level on the left and the past fan drive history on the right.

TH/Fa (温度検出/ファン駆動レベル)

TH: 温度検出値で電圧の500 %表示、基準電圧は5V
(正常値1 ~257)

Fa: 左側は現在のファン駆動レベル、右側は過去のファン駆動履歴

```
TH:125Fa:_/_
```

FAN DRIVE TEST**HIGH****FAN DRIVE TEST (ファン駆動テスト)****HIGH** : ファン駆動強

```
FanTest:HIGH
```

FAN DRIVE TEST**MID****FAN DRIVE TEST (ファン駆動テスト)****MID** : ファン駆動中

```
FanTest:MID
```

FAN DRIVE TEST**LOW****FAN DRIVE TEST (ファン駆動テスト)****LOW** : ファン駆動弱

```
FanTest:LOW
```

DVR-S200/NX-P200

10. IF STATUS (Input function status)

Using the sub-menu, the status data is displayed one after another in the hexadecimal notation.

During signal processing, the status before execution of this menu is maintained.

* Numeric values in the figure example are for reference.

IS1 (Internal status):

Indicates the status information of the microprocessor.

10. IF STATUS

サブメニュー操作により、以下のステータス情報を順次16進数で表示します。信号処理は、本メニュー実行前の状態を維持します。

※図中の数値は参考例です。

IS 1 (内部ステータス):

マイコンのステータス情報を表示します。

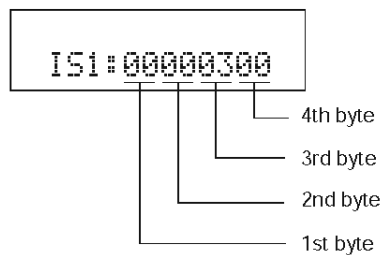

<1st byte>

Digital input/output setting value
Upper 4 bits: REC OUT selected /
lower 4 bits: INPUT selected

Value	Choice	Preset name
0	NONE	
1	NONE	
2	DIGITAL	DVD/CD
3	OPT	MD/CD-R
4	NONE	
6	NONE	
8	NONE	
9	NONE	

<第1バイト>

デジタル入出力設定値
上位4bit REC OUT 選択 /
下位4bit INPUT 選択

<2nd byte>

Fs information of reproduction signal

<第2バイト>

再生信号のFs情報

Display	00	01	02	03	04	05	06	0A	0B	0C	0D
Fs (kHz)	Analog	32	44.1	48	64	88.2	96	Unknown NRM	Unknown DBL	Unknown QUAD	Not defined

<3rd byte>

Audio code mode information of reproduction signal

<第3バイト>

再生信号のオーディオコードモード情報

Display	00	01	02	03	04	05	06	07	08	09	0A	0B	0C	0D
Audio Code	MULTI MONO	1+1	1/0	2/0	3/0	2/1	3/1	2/2	3/2	2/3	3/3	OVER 6.1	MULTI PCE	Unknown

<4th byte>

Format information of reproduction signal

<第4バイト>

再生信号のフォーマット情報

Display	Signal format
00	Analog (Unlock)
01	Incorrect digital (*1)
10	PCM Audio
20	Digital Data
21	IEC1937 Data
22	None PCM
23	Unknown
50	dts

Display	Signal format
51	Red dts
54	dts-ES MATRIX
58	dts-ES DISCRETE
5C	dts-ES (Both flag)
60	AAC
C0	Dolby Digital
C1	D.D. Karaoke
C4	D.D.6.1 (D.D.EX)

(*1): Analog processing used for digital reproduction is not possible because of a commercial bit or 4-ch audio reason.

(*1): 業務用ビットや4ch オーディオなどの理由で、デジタル再生できずアナログ処理されます。

IS2-3 (Internal status): (Not used in this model)

IS2- 3 (内部ステータス): (使用しません)

IS2:480101

IS3:01011001

CS1-5: Indicates channel status information of the input signal (IEC60958). (Not used in this model)

CS 1- 5: 入力信号のIEC60958 チャンネルステータス情報を表示します。(使用しません)

CS1:FFFFFFFF

CS5:FFFFFFFF

BY1-4: Indicates information of the bit stream included in the DOLBY DIGITAL signal. (Not used in this model)

BY1- 4: DOLBY DIGITAL 信号に含まれるビットストリームインフォメーション情報を表示します。(使用しません)

BY1:FFFFFFFF

BY4:FFFFFFFF

BC1-5: Indicates information of the bit stream included in the dts signal. (Not used in this model)

BC1- 5: dts 信号に含まれるビットストリームインフォメーション情報を表示します。(使用しません)

BC1:FFFFFFFF

BC5:00

YS1-3: Indicates device status information of YSS938 (IC303). (Not used in this model)

YS1- 3: YSS938 (IC303)のデバイスステータス情報を表示します。(使用しません)

** The numeric value in the figure is an example for reference.*

※ 図中数値は参考例です。

YS1:A6820041

YS2:00000000

YS3:60066000

CS: CS49329 Unsolicited Messages (AUTODETECT_RESPONSE) (Not used in this model)

CS: CS49329 Unsolicited Messages (AUTODETECT_RESPONSE) (使用しません)

CS :FFFFFF

MTT: Mute Trigger (Not used in this model)

MTT: Mute Trigger (使用しません)

MTT:00060000

DVR-S200/NX-P200

11. DSP RAM CHECK

This menu is used to self-diagnose whether or not the bus connection for the YSS938 and the external RAM is made properly.

During signal processing, the status before execution of this menu is maintained.

The address bus and the data bus are checked and the connection condition is displayed.

When no error is detected, "NoEr" appears on display.

11. DSP RAM CHECK

YSS938と外付けRAMとのバス接続の正否を自己診断します。信号処理は、このメニューを実行する前の状態を維持します。アドレスバス、データバスのチェックを行い、接続正否を表示します。

エラーが検出されなかった場合は、“NoEr”と表示されます。

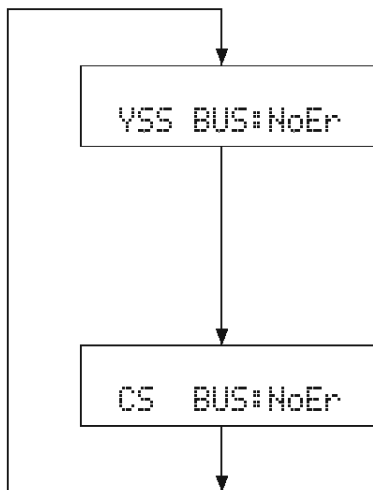

YSS938 BUS CHECK

Display	Description
WAIT	Bus is being checked.
NoEr	No error detected.
DATA	Data bus shorted or open.
RSCS	/RAS or /CAS shorted, or open.
ADDR	Address bus shorted or open.

PLD/SRAM BUS CHECK

Display	Description
WAIT	Bus is being checked.
NoEr	No error detected.
EDxx	Data bus shorted or open. (xx: 00-07)
EAXx	Address bus shorted or open. (xx: 00-0E)

12. SOFT SW

This menu is used to confirm the function settings on P.C.B..

12. SOFT SW

P.C.B. 上の機能設定を確認する機能です。

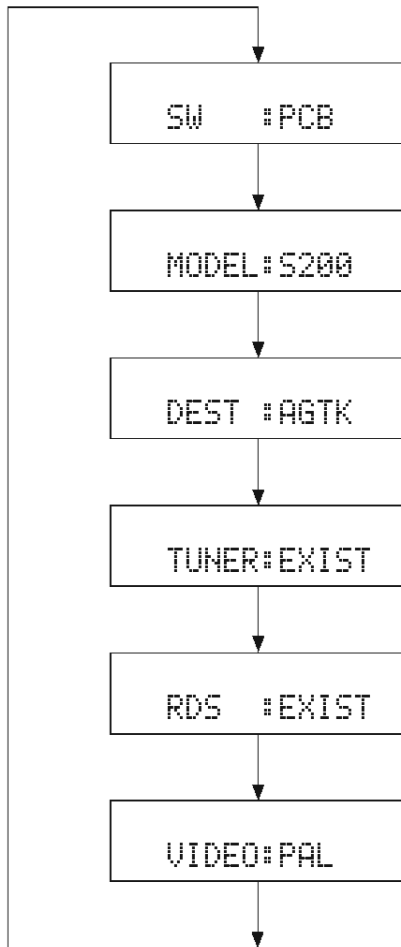

SW MODE:

Select PCB. Do not select SOFT.

PCBを選択してください。SOFTには設定しないでください。

MODEL SETTING:

Select S200. Do not select S120.

S200を選択してください。S120には設定しないでください。

TUNER DESTINATION:

J, UC, AGTK or RL can be confirmed.

J、UC、AGTK、RLのいずれかを確認できます。

TUNER:

NOT or EXIST can be confirmed.

NOTまたはEXISTを確認できます。

RDS:

NOT or EXIST can be confirmed.

NOTまたはEXISTを確認できます。

VIDEO FORMAT:

NTSC or PAL can be confirmed.

NTSCまたはPALを確認できます。

13. MICROPROCESSOR INFORMATION

The version, checksum and the port specified by the microprocessor are displayed. The signal is processed using EFFECT OFF. The checksum is obtained by adding the data at every 8 bits for each program area and expressing the result as a 4-figure hexadecimal data.

13. マイコン情報

サブメニューは4つあります。プログラムのバージョン、チェックサム、マイコンの指定ポートを表示します。信号はエフェクトOFFです。チェックサムは、プログラムエリア別にデータを8ビットごとに加算していき、4桁の16進データで現したものです。

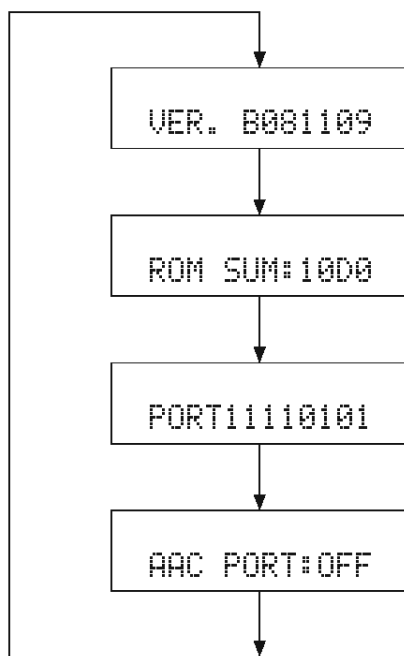

Version / バージョン情報

Release 1 digit / Main version 2 digit / DSP version 2 digit / DVD version 2 digit

Checksum / チェックサム表示

A: All area

Check of port setting for judging microprocessor function

マイコンの機能判定用ポート設定確認

Display of AAC function detection port state

AAC 機能検出ポート状態表示

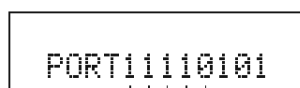

- Tuner mode 0 (*1)
- Tuner mode 1 (*1)
- Tuner with (1) / without (0)
- RDS with (1) / without (0)
- VIDEO format: PAL (1) / NTSC (0)

*1 (Tuner mode)

Tuner mode 1	Tuner mode 0	Tuner frequency
0	0	AM: 531-1611kHz/9kHz FM: 76.0-90.0MHz/100kHz
1	0	AM: 531-1611kHz/9kHz FM: 87.50-108.00MHz/50kHz
0	1	AM: 530-1710kHz/10kHz FM: 87.5-107.9MHz/200kHz
1	1	AM: 531-1611kHz/9kHz FM: 87.50-108.00MHz/50kHz

14. Other Information

14. その他の情報

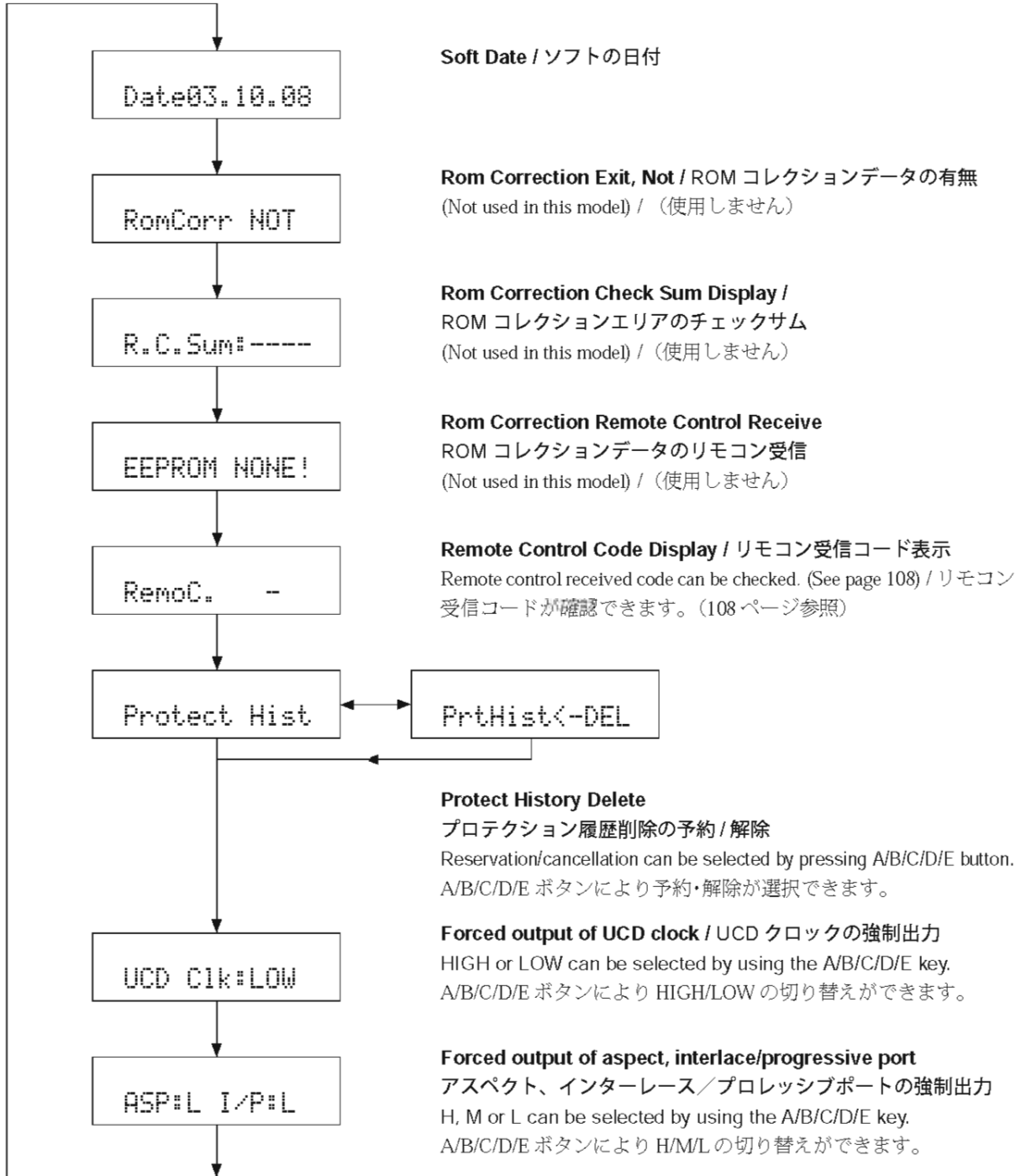

■ DVR-S200 DVD DIAG MODE / DVR-S200 DVDダイアグモード

It is possible to have the sub-CPU version, checksum and version matrix displayed by using the DVD DIAG mode.

● Operation procedure

Perform operation by using the keys on the main unit while watching the FL display of the main unit.

- 1 Press the "STANDBY/ON" key while pressing the "A/B/C/D/E" key, and the display lights up. Then within 4 seconds, press the "PROGRESSIVE" key, and the DIAG function is activated and "DVD Diag Mode" appears on the display.

The communication between the sub-CPU and DVD module starts and when it is completed in 15 to 16 seconds, "Ver. Disp" is displayed.

- 2 Press the "AUTO/MAN'L" key, and the sub-CPU version is displayed.

Example: subM=V0.350C

- 3 Press the "PRESET/TUNING ^" key, and the checksum is displayed.

Example: CSum=0x5215

- 4 Press the "PRESET/TUNING ^" key again, and the version matrix is displayed.

Example: VMtx=202096

DVDダイアグモードを使って、サブCPUのバージョン・チェックサム及びバージョンマトリックスを表示することができます。

● 操作方法

本体FLディスプレイを見ながら、本体キーを使って操作します。

- 1 “A/B/C/D/E”キーを押しながら“STANDBY/ON”キーを押し、表示点灯後4秒以内に“PROGRESSIVE”キーを押すとDVDダイアグが起動し「DVD Diag Mode」を表示します。

サブCPUとDVDモジュールが通信を開始し、15～16秒後に通信が完了すると「Ver. Disp」を表示します。

- 2 “AUTO/MAN'L”キーを押すとサブCPUのバージョンを表示します。

例:SubM=V0.350C

- 3 “PRESET/TUNING ^”キーを押すとチェックサムを表示します。

例:CSum=0x5215

- 4 もう一度“PRESET/TUNING ^”キーを押すとVersion Matrixを表示します。

例:VMtx=202096

Destination 仕向け	1st figure 1桁目	2nd figure 2桁目	3rd figure 3桁目	4th figure 4桁目	5th figure 5桁目	6th figure 6桁目
U	1	0	0	0	9	6
G (B)	2	1	1	1	8	6
J	2	0	2	0	9	6
K	3	0	2	0	9	6
L	3	1	2	0	9	6
R	3	0	2	0	9	6
A	4	1	1	1	9	6

- 5 Press the "A/B/C/D/E" key, and "Ver. Disp" is displayed again.

- 6 To cancel the DVD DIAG function, press the "STANDBY/ON" key of the main unit and turn off the power.

- 5 “A/B/C/D/E”キーを押すと「Ver. Disp」表示に戻ります。

- 6 DVDダイアグ解除

本体の“STANDBY/ON”キーを押し、電源をオフします。

■ DISPLAY DATA

V941 : 14-BT-80GNKF (WB452200)

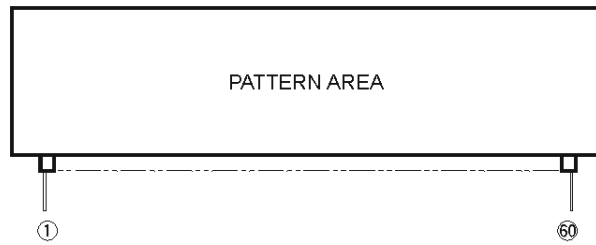

● PIN CONNECTION

Pin No.	1	2	3	4	5	6	7	8	9	10	11	12	13	14	15	16	17	18	19	20	21	22	23	24	25	26	27	28	29	30
Connection	F1	NX	NP	NP	1G	2G	3G	4G	5G	6G	7G	8G	9G	10G	11G	12G	13G	14G	NX	NX	NX	P35	P34	P33	P32	P31	P30	P29	P28	P27
Pin No.	31	32	33	34	35	36	37	38	39	40	41	42	43	44	45	46	47	48	49	50	51	52	53	54	55	56	57	58	59	60
Connection	P26	P25	P24	P23	P22	P21	P20	P19	P18	P17	P16	P15	P14	P13	P12	P11	P10	P9	P8	P7	P6	P5	P4	P3	P2	P1	NP	NP	NX	F2

Note 1) F1, F2 Filament 3) NX No extend pin 5) 1G~14G Grid
 2) NP No Pin 4) P1~P35 Datum Line

● GRID ASSIGNMENT

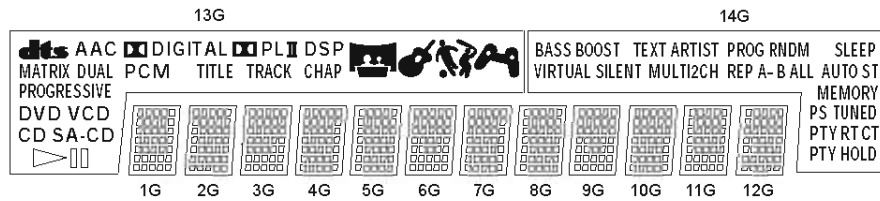

● ANODE CONNECTION

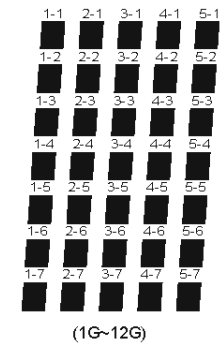

	1G ~ 12G	13G	14G
P1	1-1	S1	SLEEP
P2	2-1	S2	AUTO
P3	3-1	S3	ST
P4	4-1	S4	MEMORY
P5	5-1	CHAP	PS
P6	1-2	DSP	TUNED
P7	2-2	TRACK	PTY
P8	3-2	PL	RT
P9	4-2	II	CT
P10	5-2	TITLE	PTY HOLD
P11	1-3	DIGITAL	VIRTUAL
P12	2-3	PCM	BASS BOOST
P13	3-3	AAC	SILENT
P14	4-3	dts	TEXT
P15	5-3	DUAL	MULTI
P16	1-4	MATRIX	2CH
P17	2-4	PROGRESSIVE	ARTIST
P18	3-4	VCD	REP
P19	4-4	DVD	A-
P20	5-4	SA-CD	B
P21	1-5	CD	ALL
P22	2-5	II	PROG
P23	3-5	▶	RNDM
P24	4-5	-	-
P25	5-5	-	-
P26	1-6	-	-
P27	2-6	-	-
P28	3-6	-	-
P29	4-6	-	-
P30	5-6	-	-
P31	1-7	-	-
P32	2-7	-	-
P33	3-7	-	-
P34	4-7	-	-
P35	5-7	-	-

■ IC DATA

IC308 : M30624FGAFP (DIGITAL P.C.B.)

Main CPU

No.	Name	Port	I/O	Function	
1	P96	SOUT4	OUT	Electronic Volume IC DATA	(Serial I/O-4)
2	P95	CLK4	OUT	Electronic Volume IC CLOCK	(Serial I/O-4)
3	P94	DA1	D-A OUT	FAN D-A OUT (FAN)	[0 ~ VCC]
4	P93	DA0	OUT	DAC (CS4382) CONTROL CS OUT	[L: DATA Transfer]
5	P92	SOUT3	S-OUT	[SDM] YSS938 DATA OUT	(Serial I/O-3)
6	P91	SIN3	S-IN	[SDD] YSS938 DATA IN	(Serial I/O-3)
7	P90	CLK3	S-CLK	[SCK] YSS938 CLK OUT	(Serial I/O-3)
8	BYTE	-	-	Connect to VSS (GND)	
9	CNVSS	-	-	Connect to VSS (GND) via Resistor (5.1k-ohms)	[For flash writing: Vcc]
10	P87	CMOS	OUT	DAC (CS4382) CONTROL CLOCK OUT	
11	P86	CMOS	OUT	DAC (CS4382) CONTROL DATA OUT	
12	/RESET	-	-	RESET	[L: RESET]
13	XOUT	-	-	16MHz OUT	(with built-in feedback resistor)
14	VSS	-	-	GND	
15	XIN	-	-	16MHz IN	(with built-in feedback resistor)
16	VCC	-	-	Power supply, +5V	
17	P85	/NMI	IN	Connect to Vcc via Resistor (10 k-ohms)	(NMI function unused)
18	P84	/INT2	INT-IN	Digital AMP I Protect (ERR)	[H: Error]
19	P83	/INT1	INT-IN	[INT938] YSS938 IPINT/MUTE/DIR	
20	P82	/INT0	IN	Communication with DVD sub-microprocessor / READY IN (Pull-down resistor required)	[L: READY]
21	P81	TA4IN	IN	DC Protect (DC_PRT)	[L: when in abnormal state]
22	P80	TA4OUT	T-OUT	Digital AMP CLOCK OUT (380KHz/421KHz)	[L: Self-excited, Pulse: Separately excited]
23	P77	TA3IN	IN	HEAD PHONE Detect	(Pull-up resistor required) [H: being used]
24	P76	TA3OUT	OUT	Sub-microprocessor 8MHz OUT	
25	P75	TA2IN	OUT	Digital AMP Enable OUT	[L: Stop, H: Operation]
26	P74	TA2OUT	OUT	[/ICD] YSS938 /DA /AD /CODEC /DEM OUT	
27	P73	/CTS2	OUT	[CSY] YSS938 CE OUT	
28	P72	CLK2	S-CLK	CLK for communication with DVD sub-microprocessor	(Serial I/O-2)
29	P71	RXD2	S-IN	RxD for communication with DVD sub-microprocessor	(Serial I/O-2)
30	P70	TXD2	S-OUT	TxD for communication with DVD sub-microprocessor [Pull-up resistor N-OD required]	(Serial I/O-2)
31	P67	TXD1	S-OUT	(DATA OUT to EEPROM)/DATA OUT to Flash Writer	(Serial I/O-1)
32	P66	RXD1	S-IN	(DATA IN from EEPROM)/DATA IN from Flash Writer	(Serial I/O-1)
33	P65	CLK1	S-CLK	(CLK OUT to EEPROM)/CLK IN from Flash Writer	(Serial I/O-1)
34	P64	/CTS1	OUT	TUNER MUTE/Busy OUT to Flash Writer	
35	P63	TXD0	S-OUT	FL Driver TxD (FL_TXD)	(Serial I/O-0)
36	P62	RXD0	IN	CS-DSP INT	
37	P61	CLK0	S-CLK	FL Driver CLOCK OUT (FL_CLK)	(Serial I/O-0)
38	P60	/CTS0	OUT	IRQ OUT for communication with DVD sub-microprocessor	[H: Request]
39	P57	CLKOUT	OUT	[CSR] CS493x TxD	
40	P56	ALE	IN	[CST] CS493x RxD	
41	P55	/HOLD	IN	Connect to VSS (GND) via Resistor (10 k-ohms)	(For Flash Writing: L)
42	P54	/HLDA	OUT	[CSC] CS493x CLOCK OUT	
43	P53	BCLK	OUT	[/CSCS] CS493x CS OUT	
44	P52	/RD	OUT	[/ICCS] CS493x RESET OUT	
45	P51	/WRH	OUT	[/CSPLD] DIG EXTERNAL IC CE OUT	(when using PLD)
46	P50	/WRL	IN	Connect to Vcc via Resistor (10 k-ohms) [L when resetting : Sub-microprocessor 8MHz OUT at power OFF]	(For Flash Writing: H)
47	P47	/CS3	OUT	DVD sub-microprocessor reset	(Pull-down resistor required) [L: Reset]
48	P46	/CS2	OUT	(CS OUT to EEPROM)	(Pull-down resistor required) [H: DATA Transfer]
49	P45	/CS1	OUT	Power Relay Output (POW-RY)	[H: ON]
50	P44	/CS0	OUT	FL Driver RESET (Light OFF) OUT (FL-ON)	
51	P43	CMOS	OUT	PLL/RDS IC TxD (PLL/RDS_TXD)	
52	P42	-	IN	PLL IC RxD IN (TU_Dat_o)	
53	P41	CMOS	OUT	PLL/RDS IC CLOCK (PLL/RDS_CLK)	
54	P40	CMOS	OUT	FL Driver CE OUT (FL-CE)	[L: Address, H: Data]
55	P37	CMOS	OUT		(Pull-down resistor required)
56	P36	CMOS	OUT		(Pull-down resistor required)
57	P35	-	IN	TUNER STATION IN (STATION)	(Pull-up resistor required) [L: Station provided]
58	P34	CMOS	OUT	VMUTE 1	
59	P33	CMOS	OUT	PLL/RDS IC Chip Enable OUT (PLL/RDS_CE)	[L: Address, H: Data]

IC308 : M30624FGAFP (DIGITAL P.C.B.)

Main CPU

No.	Name	Port	I/O	Function
60	P32	-	IN	RDS IC RxD (RDS_RXD) (Pull-up resistor required)
61	P31	CMOS	OUT	VMUTE 2
62	VCC	-	-	Power supply, +5V
63	P30	CMOS	OUT	(Pull-down resistor required)
64	VSS	-	-	GND
65	P27	CMOS	OUT	Aspect Select WIDE 2
66	P26	CMOS	OUT	Aspect Select WIDE 1
67	P25	CMOS	OUT	(Pull-down resistor required)
68	P24	CMOS	OUT	VIDEO Selector D
69	P23	CMOS	OUT	VIDEO Selector C
70	P22	CMOS	OUT	VIDEO Selector B
71	P21	CMOS	OUT	VIDEO Selector A
72	P20	CMOS	OUT	BLK OUT [L: RGB]
73	P17	/INT5	INT-IN	Remote Control IN (REMOTE)
74	P16	/INT4	INT-IN	Standby SW IN [H: ON]
75	P15	/INT3	INT-IN	Power Down DETECT INT IN [L: POWER DOWN]
76	P14	CMOS	OUT	Full MUTE (+ HP Muting available) OUT (Not used) [L: MUTE]
77	P13	CMOS	OUT	Sub-woofer Mute OUT [L: MUTE]
78	P12	CMOS	OUT	4053_3
79	P11	CMOS	OUT	4053_2
80	P10	CMOS	OUT	4053_1
81	P07	CMOS	OUT	Input Select/Electronic Volume IC CLOCK (BD3842FS/BD3815KS 2-wire serial) (CKBD)
82	P06	CMOS	OUT	Input Select/Electronic Volume IC DATA (BD3842FS/BD3815KS 2-wire serial) (DTBD)
83	P05	CMOS	OUT	HP MUTE OUT [L: MUTE]
84	P04	-	IN	Rotary Encoder B (ROT-2) (Pull-up resistor required)
85	P03	-	IN	Rotary Encoder A (ROT-1) (Pull-up resistor required)
86	P02	CMOS	OUT	Electronic Volume IC Chip Enable OUT
87	P01	CMOS	OUT	Electronic Volume IC DC Bias Initialize (Reset) OUT
88	P00	CMOS	OUT	DAC (CS4382) Reset OUT [L: Reset]
89	P107	AN7	A-D IN	Destination Select Input [0 ~ VREF]
90	P106	AN6	IN	TUNER STEREO Detect IN (Pull-up resistor required)
91	P105	AN5	A-D IN	(Pull-up at 100 k-ohms) [0 ~ VREF]
92	P104	AN4	A-D IN	Key AD Input 0 (KEY0) [0 ~ VREF]
93	P103	AN3	A-D IN	Temperature Detect (Thermistor) IN (for driving FAN) [0 ~ VREF]
94	P102	AN2	A-D IN	Power Voltage Detect 1 (V Protect) IN (V1-PRT) [0 ~ VREF]
95	P101	AN1	IN	AC Power Voltage Detect (AC Protect) IN (AC-PRT) [H: when in abnormal state]
96	AVSS	-	-	Connect to VSS (GND)
97	P100	AN0	OUT	Power Voltage Detect 2 (V2 Protect) IN (V2-PRT) [0 ~ VREF]
98	VREF	-	-	A-D, D-A Reference Voltage Input [~ VCC]
99	AVCC	-	-	Connect to VCC Terminal (+5V)
100	P97	SIN4	IN	(Used as Design Test Port) (Pull-down resistor required)

● KEY INPUT (A-D) PULL UP RESISTOR 10kΩ

Ω	0	+1.2k	+1.2k	+1.8k	+2.7k	+3.3k	+4.7k	+8.2k	+18k	+47k
V	0 ~ 0.25	~ 0.75	~ 1.25	~ 1.75	~ 2.25	~ 2.75	~ 3.25	~ 3.75	~ 4.25	~ 4.75
KEY 0 (92pin)	STOP A/B/C/D/E	SKIP/SEARCH - PRESET/TUNING -	SKIP/SEARCH + PRESET/TUNING +	PAUSE PRESET/BAND	DSP +	INPUT +	PLAY AUTO/MAN'L	PROGRESSIVE MEMORY	OPEN	NO KEY

● TUNER MARKET & DVD REGION SELECT IN (89 pin, A-D) PULL UP RESISTOR 10kΩ

Ω	4.3k	6.8k	10k	15k	24k	39k	91k	∞ (pull-up only)
V	1.25 ~ 1.75	~ 2.25	~ 2.75	~ 3.25	~ 3.75	~ 4.25	~ 4.75	4.75 ~ 5
Market	T	K	L (9K/50K) (10K/100K)	R (9K/50K) (10K/100K)	A	U, C	B, G	J
Region	6	3	3	3	4	1	2	2

DVR-S200/NX-P200

**IC307 : M38517FP (DIGITAL P.C.B.)
SUB CPU**

No.	Name	Port	I/O	Function
1	VCC	-	-	Power supply, +5V
2	VREF	-	-	A-D, D-A Reference Voltage Input [~ VCC]
3	AVSS	-	-	Connect to Vss (GND)
4	P44	INT3	OUT	(Pull-down resistor required)
5	P43	INT2	OUT	(Pull-down resistor required)
6	P42	INT1	INT-IN	Interrupt Request from Main Microprocessor [H: IRQ]
7	P41	INT0	IN	Connect to Vcc (+5V) via Resistor (10 k-ohms) [For Flash Writing: Vcc]
8	P40	CMOS	OUT	(Pull-down resistor required)
9	P27	/RDY1	OUT	BUSY OUT to Flash Writer
10	P26	SCLK1	S-CLK	CLK IN from Flash Writer (Serial I/O-1)
11	P25	TxD1	S-OUT	DATA OUT to Flash Writer (Serial I/O-1)
12	P24	RxD1	S-IN	DATA IN from Flash Writer (Serial I/O-1)
13	P23	SCL1	N-OUT	IIC SCL (Communication with DVD Module) [Pull-up resistor required] (Serial I/O-I2C)
14	P22	SDA1	N-OUT	IIC SDA (Communication with DVD Module) [Pull-up resistor required] (Serial I/O-I2C)
15	CNVSS	-	-	Connect to Vss (GND) via Resistor (5.1 k-ohms) [For Flash Writing: Vcc]
16	P21	CMOS	OUT	(Pull-down resistor required)
17	P20	CMOS	OUT	(Pull-down resistor required)
18	/RESET	-	-	RESET (Test land required) [L: RESET]
19	XIN	-	-	8MHz IN (with built-in feedback resistor)
20	XOUT	-	-	8MHz OUT (with built-in feedback resistor)
21	VSS	-	-	GND
22	P17	CMOS	IN/OUT	General purpose I/O P17 (Pull-down resistor required)
23	P16	CMOS	IN/OUT	General purpose I/O P16 (Pull-down resistor required)
24	P15	CMOS	IN/OUT	General purpose I/O P15 (Pull-down resistor required)
25	P14	CMOS	IN/OUT	General purpose I/O P14 (Pull-down resistor required)
26	P13	CMOS	IN/OUT	General purpose I/O P13 (Pull-down resistor required)
27	P12	CMOS	IN/OUT	General purpose I/O P12 (Pull-down resistor required)
28	P11	CMOS	IN/OUT	General purpose I/O P11 (Pull-down resistor required)
29	P10	CMOS	IN/OUT	General purpose I/O P10 (Pull-down resistor required)
30	P07	CMOS	OUT	DVD Unit Power Supply 3 OUT [H: ON]
31	P06	CMOS	OUT	DVD Unit Power Supply 2 OUT [H: ON]
32	P05	CMOS	OUT	DVD Unit Power Supply 1 OUT (Pull-down resistor required)
33	P04	CMOS	OUT	(Pull-down resistor required)
34	P03	SRDY2	OUT	RDY OUT to Main Microprocessor (Serial I/O-2)
35	P02	SCLK2	S-CLK	CLK IN from Main Microprocessor (Serial I/O-2)
36	P01	SOUT2	S-OUT	DATA OUT to Main Microprocessor (Serial I/O-2)
37	P00	SIN2	S-IN	DATA IN from Main Microprocessor (Serial I/O-2)
38	P34	CMOS	OUT	(Pull-down resistor required)
39	P33	CMOS	OUT	(Pull-down resistor required)
40	P32	CMOS	OUT	(Pull-down resistor required)
41	P31	CMOS	OUT	(Pull-down resistor required)
42	P30	AN0	A-D IN	Key AD Input for TEST [0 ~ VREF]

IC303 : YSS938 (DIGITAL P.C.B.)
DSP

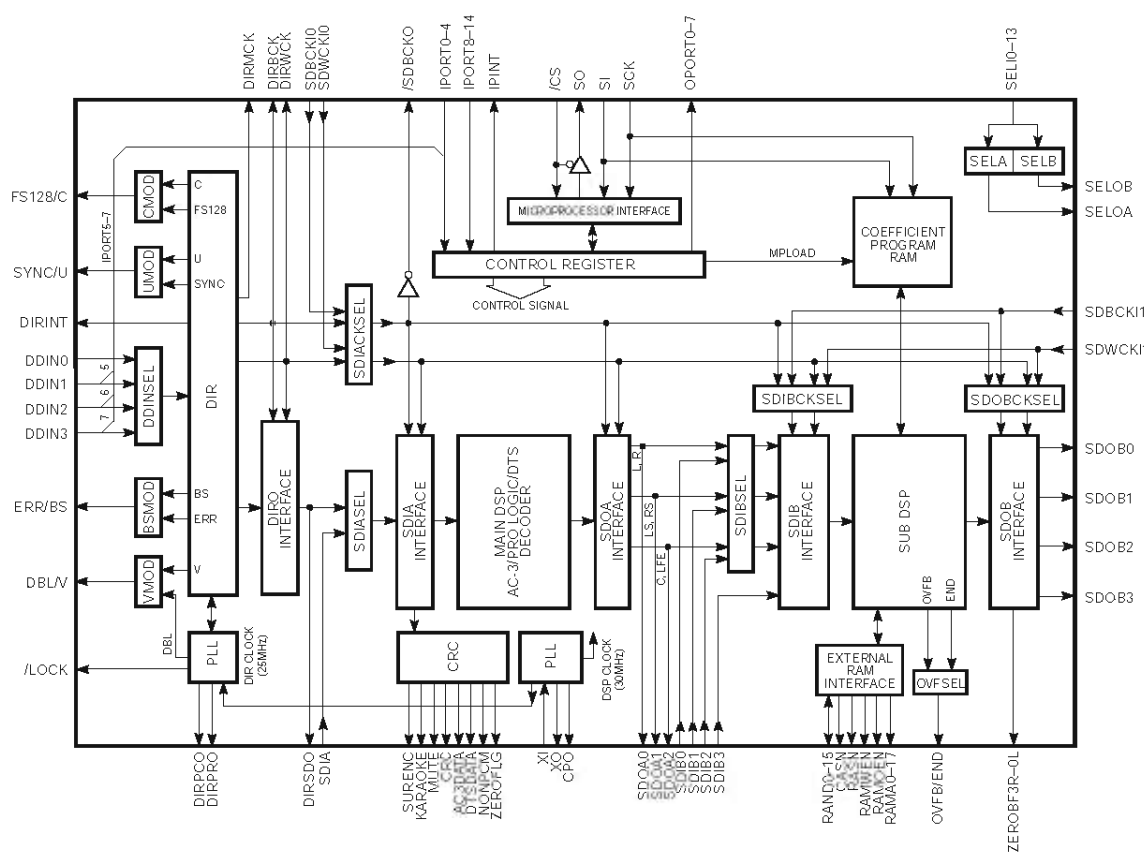
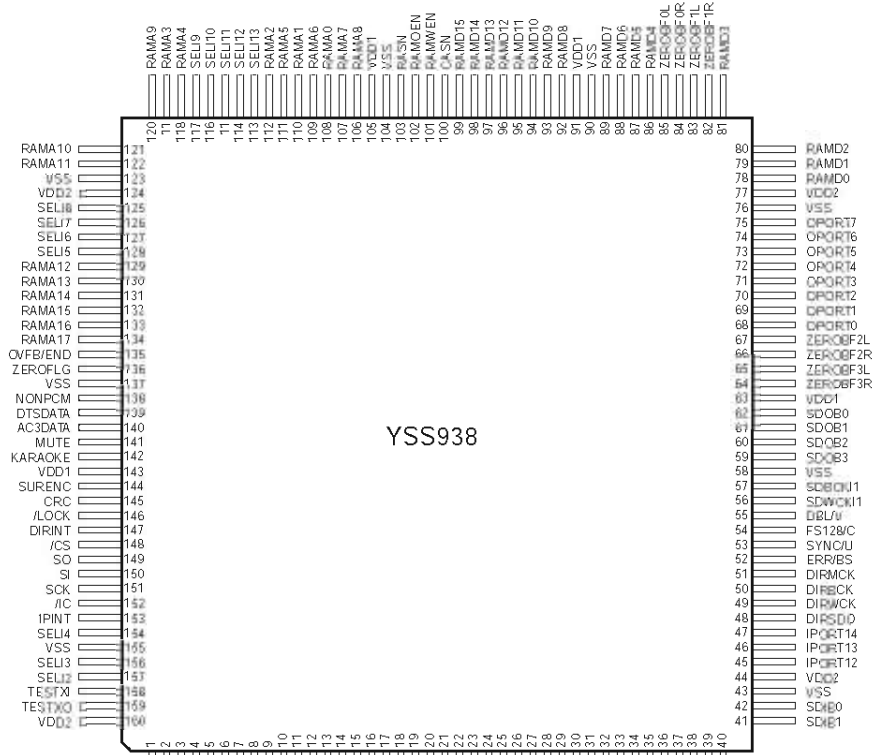

DVR-S200/NX-P200

IC303 : YSS938 (DIGITAL P.C.B.)

DSP

No.	Name	I/O	Function
1	XO	O	Crystal oscillator connecting terminal
2	XI	I	Crystal oscillator connecting terminal (24.576MHz)
3	SEL1	I+	Built-in selector input 1 (Unconnected)
4	SEL10	I+	Built-in selector input 0 (GND)
5	SELOA	O+	Built-in selector output A (ISEL)
6	SELOB	O+	Built-in selector output B (RSEL)
7	TESTMS	I+	Test terminal (unconnected)
8	TESTXEN	I+	Test terminal (unconnected)
9	IPOINT0	I+	General purpose input terminal (Pull down)
10	IPOINT1	I+	General purpose input terminal (GND)
11	IPOINT2	I+	General purpose input terminal (GND)
12	IPOINT3	I+	General purpose input terminal (GND)
13	IPOINT4	I+	General purpose input terminal (GND)
14	DDIN0	Is	DIR: Digital audio interface data input terminal 0 (ISEL)
15	DDIN1	Is	DIR: Digital audio interface data input terminal 1/General purpose input terminal (Pull down)
16	DDIN2	Is	DIR: Digital audio interface data input terminal 2/General purpose input terminal (Pull down)
17	DDIN3	Is	DIR: Digital audio interface data input terminal 3/General purpose input terminal (Pull down)
18	VSS		Ground terminal
19	CPO	A	PLL filter connecting terminal
20	AVDD		+3.3V power terminal (for DIR)
21	DIRPCO	A	DIR: PLL filter connecting terminal
22	DIRPRO	A	DIR: PLL filter connecting terminal
23	AVSS		Ground terminal (for DIR)
24	TESTBRK	I+	Test terminal (Unconnected)
25	TESTR1	I+	PLL initialization signal input terminal for DSP (/ICD)
26	TESTR2	I+	Test terminal (Unconnected)
27	VDD1		+3.3V power terminal (for terminal section)
28	SDWCKI0	I+	Word clock input terminal for SDIA, SDOA, SDIB, SDOB interface (Unconnected)
29	SDBCKI0	I+	Bit clock input terminal for SDIA, SDOA, SDIB, SDOB interface (Unconnected)
30	/SDBCK0	O	DIRBCK or SDBCKI0 invert clock output terminal (Unconnected)
31	IPOINT8	I+	IPINT general purpose input terminal
32	IPOINT9	I+	IPINT general purpose input terminal
33	IPOINT10	I+	IPINT general purpose input terminal (NONPCM)
34	IPOINT11	I+	IPINT general purpose input terminal (NONPCM)
35	SDIA	I	AC-3/DTS bit stream (or PCM) data input terminal to Main DSP
36	SDOA2	O	PCM output terminal from Main DSP (C/LFE output) (Unconnected)
37	SDOA1	O	PCM output terminal from Main DSP (LS/RS output) (Unconnected)
38	SDOA0	O	PCM output terminal from Main DSP (L/R output) (Unconnected)
39	SDIB3	I+	PCM input terminal 3 to Sub DSP
40	SDIB2	I+	PCM input terminal 2 to Sub DSP
41	SDIB1	I+	PCM input terminal 1 to Sub DSP
42	SDIB0	I+	PCM input terminal 0 to Sub DSP
43	VSS		Ground terminal
44	VDD2		+2.5V power terminal (for internal circuit)
45	IPOINT12	I+	IPINT general purpose input terminal (MUTE)
46	IPOINT13	I+	IPINT general purpose input terminal (DIRINT)
47	IPOINT14	I+	IPINT general purpose input terminal (Unconnected)
48	DIRSDO	O	AC-3/DTS bit stream (or PCM) data output terminal from DIR
49	DIRWCK	O	DIR: Serial data word clock (fs) output terminal (WCK)
50	DIRBCK	O	DIR: Serial data bit clock (64fs) output terminal (BCK)
51	DIRMCK	O	DIR: Serial data master clock (256fs or 128fs) output terminal (MCK)
52	ERR/BS	O	DIR: Data error detect output/block start output terminal (Unconnected)
53	SYNC/U	O	DIR: Serial data synchronous timing output/user data output terminal (Unconnected)
54	FS128/C	O	DIR: Serial data master clock 128fs output/channel status output terminal (Unconnected)
55	DBL/V	O	DIR: Double rate clock output/validity flag output terminal (Unconnected)

IC303 : YSS938 (DIGITAL P.C.B.)

DSP

No.	Name	I/O	Function
56	SDWCKI1	I+	Word clock input terminal for SDIB, SDOB interface (Unconnected)
57	SDBCKI1	I+	Bit clock input terminal for SDIB, SDOB interface (Unconnected)
58	VSS		Ground terminal
59	SDOB3	O	PCM output terminal from Sub DSP
60	SDOB2	O	PCM output terminal from Sub DSP
61	SDOB1	O	PCM output terminal from Sub DSP
62	SDOB0	O	PCM output terminal from Sub DSP
63	VDD1		+3.3V power terminal (for terminal section)
64	ZEROBF3R	O+	SDOB3 Rch zero flag output terminal (Unconnected)
65	ZEROBF3L	O+	SDOB3 Lch zero flag output terminal (Unconnected)
66	ZEROBF2R	O+	SDOB2 Rch zero flag output terminal (Unconnected)
67	ZEROBF2L	O+	SDOB2 Lch zero flag output terminal (Unconnected)
68	OPORT0	O	General purpose output terminal (Unconnected)
69	OPORT1	O	General purpose output terminal (Unconnected)
70	OPORT2	O	General purpose output terminal (ICDA)
71	OPORT3	O	General purpose output terminal (Unconnected)
72	OPORT4	O	General purpose output terminal (ICAD)
73	OPORT5	O	General purpose output terminal (CLKSEL)
74	OPORT6	O	General purpose output terminal (MEMACS)
75	OPORT7	O	General purpose output terminal (Unconnected)
76	VSS		Ground terminal
77	VDD2		+2.5V power terminal (for internal circuit)
78	RAMD0	I+/O	Sub DSP: External memory data terminal 0
79	RAMD1	I+/O	Sub DSP: External memory data terminal 1
80	RAMD2	I+/O	Sub DSP: External memory data terminal 2
81	RAMD3	I+/O	Sub DSP: External memory data terminal 3
82	ZEROBF1R	O+	SDOB1 Rch zero flag output terminal (Unconnected)
83	ZEROBF1L	O+	SDOB1 Lch zero flag output terminal (Unconnected)
84	ZEROBF0R	O+	SDOB0 Rch zero flag output terminal (Unconnected)
85	ZEROBF0L	O+	SDOB0 Lch zero flag output terminal (Unconnected)
86	RAMD4	I+/O	Sub DSP: External memory data terminal 4
87	RAMD5	I+/O	Sub DSP: External memory data terminal 5
88	RAMD6	I+/O	Sub DSP: External memory data terminal 6
89	RAMD7	I+/O	Sub DSP: External memory data terminal 7
90	VSS		Ground terminal
91	VDD1		+3.3V power terminal (for terminal section)
92	RAMD8	I+/O	Sub DSP: External memory data terminal 8
93	RAMD9	I+/O	Sub DSP: External memory data terminal 9
94	RAMD10	I+/O	Sub DSP: External memory data terminal 10
95	RAMD11	I+/O	Sub DSP: External memory data terminal 11
96	RAMD12	I+/O	Sub DSP: External memory data terminal 12
97	RAMD13	I+/O	Sub DSP: External memory data terminal 13
98	RAMD14	I+/O	Sub DSP: External memory data terminal 14
99	RAMD15	I+/O	Sub DSP: External memory data terminal 15
100	CASN	O	Sub DSP: Column address strobe output terminal for external DRAM
101	RAMWEN	O	Sub DSP: Write enable terminal for external memory
102	RAMOEN	O	Sub DSP: Output enable terminal for external memory
103	RASN	O	Sub DSP: Low address strobe output terminal for external DRAM
104	VSS		Ground terminal
105	VDD1		+3.3V power terminal (for terminal section)
106	RAMA8	O	Sub DSP: External memory address terminal 8
107	RAMA7	O	Sub DSP: External memory address terminal 7
108	RAMA0	O	Sub DSP: External memory address terminal 0
109	RAMA6	O	Sub DSP: External memory address terminal 6
110	RAMA1	O	Sub DSP: External memory address terminal 1

DVR-S200/NX-P200

IC303 : YSS938 (DIGITAL P.C.B.)

DSP

No.	Name	I/O	Function
111	RAMA5	O	Sub DSP: External memory address terminal 5
112	RAMA2	O	Sub DSP: External memory address terminal 2
113	SELI13	I+	Built-in selector input 13 (Unconnected)
114	SELI12	I+	Built-in selector input 12 (Unconnected)
115	SELI11	I+	Built-in selector input 11 (Unconnected)
116	SELI10	I+	Built-in selector input 10 (Unconnected)
117	SELI9	I+	Built-in selector input 9 (Unconnected)
118	RAMA4	O	Sub DSP: External memory address terminal 4
119	RAMA3	O	Sub DSP: External memory address terminal 3
120	RAMA9	O	Sub DSP: External memory address terminal 9 (Unconnected)
121	RAMA10	O	Sub DSP: External memory address terminal 10 (Unconnected)
122	RAMA11	O	Sub DSP: External memory address terminal 11 (Unconnected)
123	VSS		Ground terminal
124	VDD2		+2.5V power terminal (for internal circuit)
125	SELI8	I+	Built-in selector input 8 (Unconnected)
126	SELI7	I+	Built-in selector input 7 (GND)
127	SELI6	I+	Built-in selector input 6 (Unconnected)
128	SELI5	I+	Built-in selector input 5 (Unconnected)
129	RAMA12	O	Sub DSP: External memory address terminal 12 (Unconnected)
130	RAMA13	O	Sub DSP: External memory address terminal 13 (Unconnected)
131	RAMA14	O	Sub DSP: External memory address terminal 14 (Unconnected)
132	RAMA15	O	Sub DSP: External memory address terminal 15 (Unconnected)
133	RAMA16	O	Sub DSP: External memory address terminal 16 (Unconnected)
134	RAMA17	O	Sub DSP: External memory address terminal 17 (Unconnected)
135	OVFB/END	O	Sub DSP: Overflow/program end detect terminal (Unconnected)
136	ZEROF LG	O	Main DSP: Zero flag output terminal (Unconnected)
137	VSS		Ground terminal
138	NONPCM	O	Main DSP: Non-PCM data detect terminal
139	DTSDATA	O	Main DSP: DTS data detect terminal (Unconnected)
140	AC3DATA	O	Main DSP: AC3 data detect terminal (Unconnected)
141	MUTE	O	Main DSP: Auto mute detect terminal (MUTE)
142	KARAOKE	O	Main DSP: AC3 KARAOKE data detect terminal (Unconnected)
143	VDD1		+3.3V power terminal (for terminal section)
144	SURENC	O	Main DSP: AC-3 2/0 mode Dolby surround encode input detect terminal (Unconnected)
145	CRC	O	Main DSP: AC3 CRC error detect terminal (Unconnected)
146	/LOCK	O	DIR: PLL lock detect terminal (Unconnected)
147	DIRINT	O	DIR: Interrupt output terminal
148	/CS	Is	Microprocessor interface chip select input terminal (CSY)
149	SO	Ot	Microprocessor interface data output terminal
150	SI	Is	Microprocessor interface data input terminal (SDM)
151	SCK	Is	Microprocessor interface clock input terminal (YSSCK)
152	/IC	Is	Initial clear input terminal (/ICD)
153	IPINT	O+	Interrupt output terminal by IPORT 8-14
154	SELI4	I+	Built-in selector input 4 (Unconnected)
155	VSS		Ground terminal
156	SELI3	I+	Built-in selector input 3 (OPTA)
157	SELI2	I+	Built-in selector input 2 (SPDIF)
158	TESTXI	I	Test terminal (should be always connected to VSS)
159	TESTXO	O	Test terminal (Unconnected)
160	VDD2		+2.5V power terminal (for internal circuit)

Is: Schmidt trigger input terminal

I+: Input terminal with pull-up resistor

O: digital output terminal

Ot: Tri-state digital output terminal

A: Analog terminal

IC302 : XC9572XL-10Q100C (DIGITAL P.C.B.)J only
PLD

	100	99	98	97	96	95	94	93	92	91	90	89	88	87	86	85	84	83	82	81	80	79	78	77	76			
ZIN2	1																									75	GND	
NC	2																										74	CSIO[7]
ZIN3	3																										73	NC
PGND	4																										72	CSIO[6]
VCC	5																										71	CSIO[5]
FMEMENINV	6																										70	CSIO[4]
NC	7																										69	GND
FMEMEN	8																										68	CSIO[3]
EXMEM_ON	9																										67	CSIO[2]
EMWR_ON	10																										66	CSIO[1]
PAGE[0]	11																										65	CSIO[0]
PAGE[1]	12																										64	ZSEL[0]
PAGE[2]	13																										63	XOUT
PAGE[3]	14																										62	GND
A[0]	15																										61	CSCSO
A[1]	16																										60	PGND
A[2]	17																										59	EXMEM_IN
A[3]	18																										58	D[7]
NC	19																										57	VCC
ZSEL[1]	20																										56	D[6]
GND	21																										55	D[5]
CSPLDI	22																										54	D[4]
XIN1	23																										53	D[3]
NC	24																										52	D[2]
XIN2	25																										51	VCC
		26	27	28	29	30	31	32	33	34	35	36	37	38	39	40	41	42	43	44	45	46	47	48	49	50		
		VCC	A[4]	A[5]	A[6]	A[7]	GND	A[8]	A[9]	NC	A[10]	A[11]	A[12]	VCC	A[13]	A[14]	YIN1	YIN2	NC	NC	TDI	NC	TMS	TCK	D[0]	D[1]		

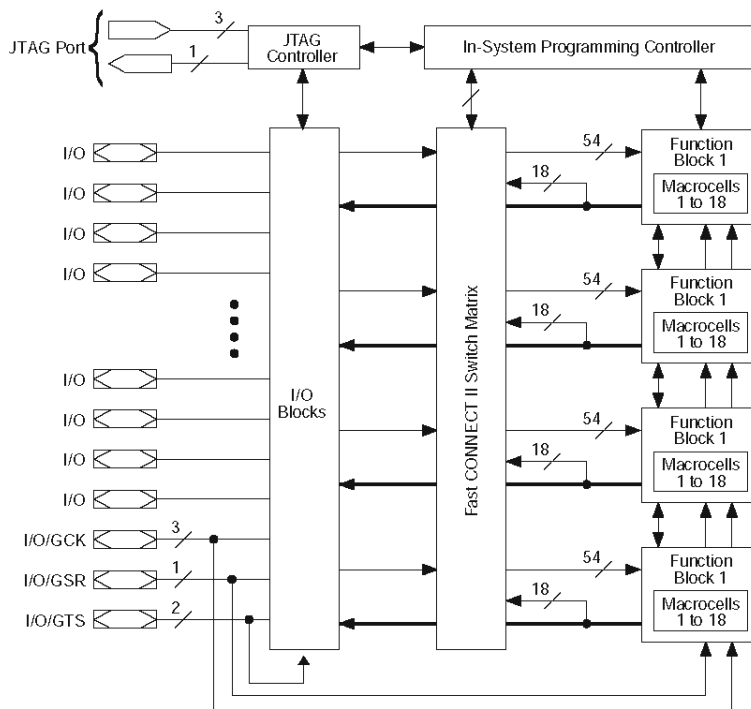

DVR-S200/NX-P200

IC302 : XC9572XL-10Q100C (DIGITAL P.C.B.) J only

PLD

NO.	端子名	信号線名称	I/O	機能
1	ZIN2		IN	MAIN DAC "SDATA" 用 セレクタ入力端子 : AUDATA0 (GND)
2	N.C.			N.C.
3	ZIN3		IN	MAIN DAC "SDATA" 用 セレクタ入力端子 : SDOA0 (GND)
4	PGND			電源 (0V)
5	VCC			電源 (+3.3V)
6	FMEMENINV	FMEINV	OUT	SRAMチップセレクト
7	N.C.			N.C.
8	FMEMEN		OUT	Flash Memory チップセレクト (未接続)
9	EXMEM_ON	/EMOE	OUT	外部メモリ用 Output Enable 出力
10	EMWR_ON	/EMWE	OUT	外部メモリ用 Write Enable 出力
11	PAGE[0]		OUT	Flash Memory Page Select (上位アドレスバスに接続) (未接続)
12	PAGE[1]		OUT	Flash Memory Page Select (上位アドレスバスに接続) (未接続)
13	PAGE[2]		OUT	Flash Memory Page Select (上位アドレスバスに接続) (未接続)
14	PAGE[3]		OUT	Flash Memory Page Select (上位アドレスバスに接続) (未接続)
15	A[0]	EMA[0]	OUT	外部メモリアクセス用アドレスバス
16	A[1]	EMA[1]	OUT	外部メモリアクセス用アドレスバス
17	A[2]	EMA[2]	OUT	外部メモリアクセス用アドレスバス
18	A[3]	EMA[3]	OUT	外部メモリアクセス用アドレスバス
19	N.C.			N.C.
20	ZSEL[1]		IN	MAIN DAC "SDATA" 用 セレクタ制御信号入力端子 (未接続) 00 : zout = GND 10 : zout = AUDATO 01 : zout = SDOB3 11 : zout = SDOA0
21	GND			電源 (0V)
22	CSPLDI	/CSPLD	IN	PLD用チップセレクト (Low アクティブ)
23	XIN1	SDAO	IN	YSS938 "SDIB0" 用 セレクタ入力端子 : SDAO(ADC 出力信号)
24	N.C.			N.C.
25	XIN2	SDIB0	IN	YSS938 "SDIB0" 用 セレクタ入力端子 : AUDATA0(tout 出力)
26	VCC			電源 (+3.3V)
27	A[4]	EMA[4]	OUT	外部メモリアクセス用アドレスバス
28	A[5]	EMA[5]	OUT	外部メモリアクセス用アドレスバス
29	A[6]	EMA[6]	OUT	外部メモリアクセス用アドレスバス
30	A[7]	EMA[7]	OUT	外部メモリアクセス用アドレスバス
31	GND			電源 (0V)
32	A[8]	EMA[8]	OUT	外部メモリアクセス用アドレスバス
33	A[9]	EMA[9]	OUT	外部メモリアクセス用アドレスバス
34	N.C.			N.C.
35	A[10]	EMA[10]	OUT	外部メモリアクセス用アドレスバス
36	A[11]	EMA[11]	OUT	外部メモリアクセス用アドレスバス
37	A[12]	EMA[12]	OUT	外部メモリアクセス用アドレスバス
38	VCC			電源 (+3.3V)
39	A[13]	EMA[13]	OUT	外部メモリアクセス用アドレスバス
40	A[14]	EMA[14]	OUT	外部メモリアクセス用アドレスバス
41	YIN1	DIRSDO	IN	CS49329 "SDATAN" 用 セレクタ入力端子 : DIRSDO
42	YIN2	SDOA0	IN	CS49329 "SDATAN" 用 セレクタ入力端子 : SDOA0
43	N.C.			N.C.
44	GND			電源 (0V)
45	TDI			Test Data In
46	N.C.			N.C.
47	TMS			Test Mode Select
48	TCK			Test Clock
49	D[0]	EMD[0]	I/O	外部メモリアクセス用 Data バス
50	D[1]	EMD[1]	I/O	外部メモリアクセス用 Data バス
51	VCC			電源 (+3.3V)
52	D[2]	EMD[2]	I/O	外部メモリアクセス用 Data バス
53	D[3]	EMD[3]	I/O	外部メモリアクセス用 Data バス

IC302 : XC9572XL-10Q100C (DIGITAL P.C.B.) J only
 PLD

NO.	端子名	信号線名称	I/O	機能
54	D[4]	EMD[4]	I/O	外部メモリアクセス用 Data /A
55	D[5]	EMD[5]	I/O	外部メモリアクセス用 Data /A
56	D[6]	EMD[6]	I/O	外部メモリアクセス用 Data /A
57	VCC			電源 (+3.3V)
58	Z[1]	EMD[1]	I/O	外部メモリアクセス用 Data /A
59	EXMEM_IN	/EXM2	IN	External Memory OUT Enable from CS49329
60	PGND			電源 (0V)
61	CSGCSO	/CSGCS3	OUT	CS49329用チップセレクト出力 (cscsiのヌル)
62	GND			電源 (0V)
63	XOUT	SDIA	OUT	YSS939 "SDIA"用セリクタ出力端子
64	ZSEL[0]		IN	MAIN DAC "SDATA"用セリクタ制御信号入力端子 (未接続) 00 : zout = GND 01 : zout = SDOB3
65	CSIO[0]	GPIO[0]	I/O	CS49329/GPIO /A
66	CSIO[1]	GPIO[1]	I/O	CS49329/GPIO /A
67	CSIO[2]	GPIO[2]	I/O	CS49329/GPIO /A
68	CSIO[3]	GPIO[3]	I/O	CS49329/GPIO /A
69	GND			電源 (0V)
70	CSIO[4]	GPIO[4]	I/O	CS49329/GPIO /A
71	CSIO[5]	GPIO[5]	I/O	CS49329/GPIO /A
72	CSIO[6]	GPIO[6]	I/O	CS49329/GPIO /A
73	N.C.			N.C.
74	CSIO[7]	GPIO[7]	I/O	CS49329/GPIO /A
75	GND			電源 (0V)
76	PGND			電源 (0V)
77	SCK[0]	SKCCL	OUT	DSP /V1/A(CS49329/VSS939)への Serial Clock 出力
78	PGND			電源 (0V)
79	SDMO	SDMIN	OUT	DSP /V1/A(CS49329/VSS939)への Serial Data 出力
80	N.C.			N.C.
81	PGND			電源 (0V)
82	EMOE_IN	/EMOE2	IN	External Memory Enable(latch clock) from CS49329
83	TDO			Test Data Out
84	GND			電源 (0V)
85	EMWR_IN	/EMWE2	IN	External Memory Write Enable from CS49329
86	ABOOT		OUT	CS49329 Auto Boot 用出力 (Low or Hi-Z 出力) (未接続)
87	SDDO	SDDO	OUT	PLDからマイコンへの Serial Data 出力。 Read Data 送信時以外は Hi-Z
88	VCC			電源 (+3.3V)
89	TOUT[0]	/CSRST	OUT	CS49329 "RESET" のヌル出力端子。
90	YOUT		OUT	CS49329 "SDATA" 用セリクタ出力端子 (未接続)
91	ZOUT		OUT	MAIN DAC "SDATA" 用セリクタ出力端子 (未接続)
92	MEMACS	MEMACS	IN	マイコンからの Serial Clock 入力
93	SCK1	CSG	IN	マイコンからの Serial Data 入力
94	TIN	/ICCS	IN	CS49329 "RESET" の入力端子。 番号は、ヌルで Iout 端子から出力される
95	SDM1	SDM	IN	マイコンからの Serial Data 入力
96	CSGCSI	/CSGCS	IN	CS49329用チップセレクト出力
97	ZIN1		IN	MAIN DAC "SDATA" 用セリクタ入力端子 (GND)
98	VCC			電源 (+3.3V)
99	RST	/ICD	IN	PLDからマイコンへの (Low → Hi-Z) セリクタ出力
100	GND			電源 (0V)

DVR-S200 BLOCK DIAGRAM (1/3) / ブロックダイアグラム

DVD Module

Front-end

Back-end

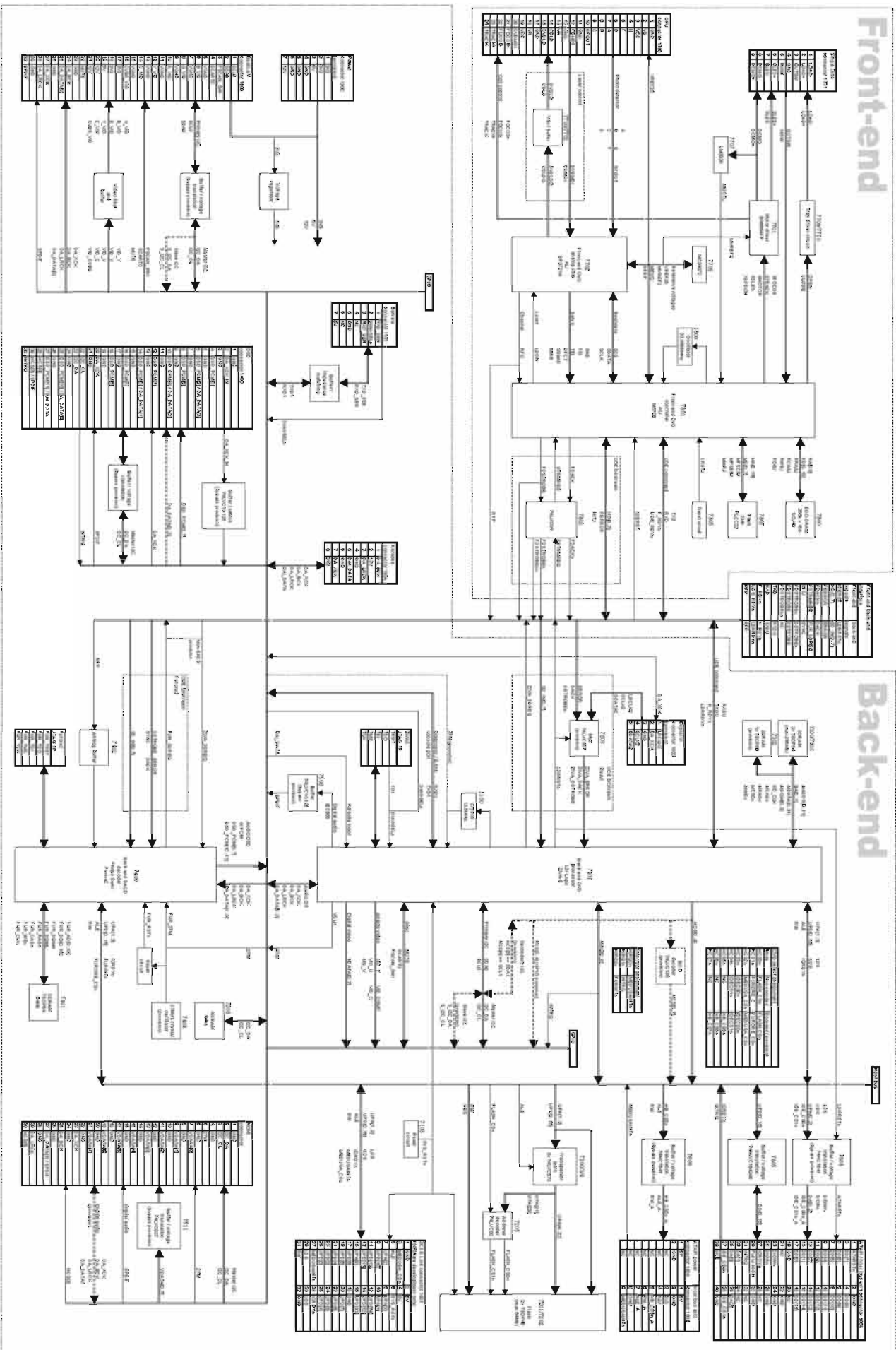

DVR-S200 BLOCK DIAGRAM (2/3) / ブロックダイアグラム

MAIN See page 82 SCHEMATIC DIAGRAM

SUB See page 86 SCHEMATIC DIAGRAM

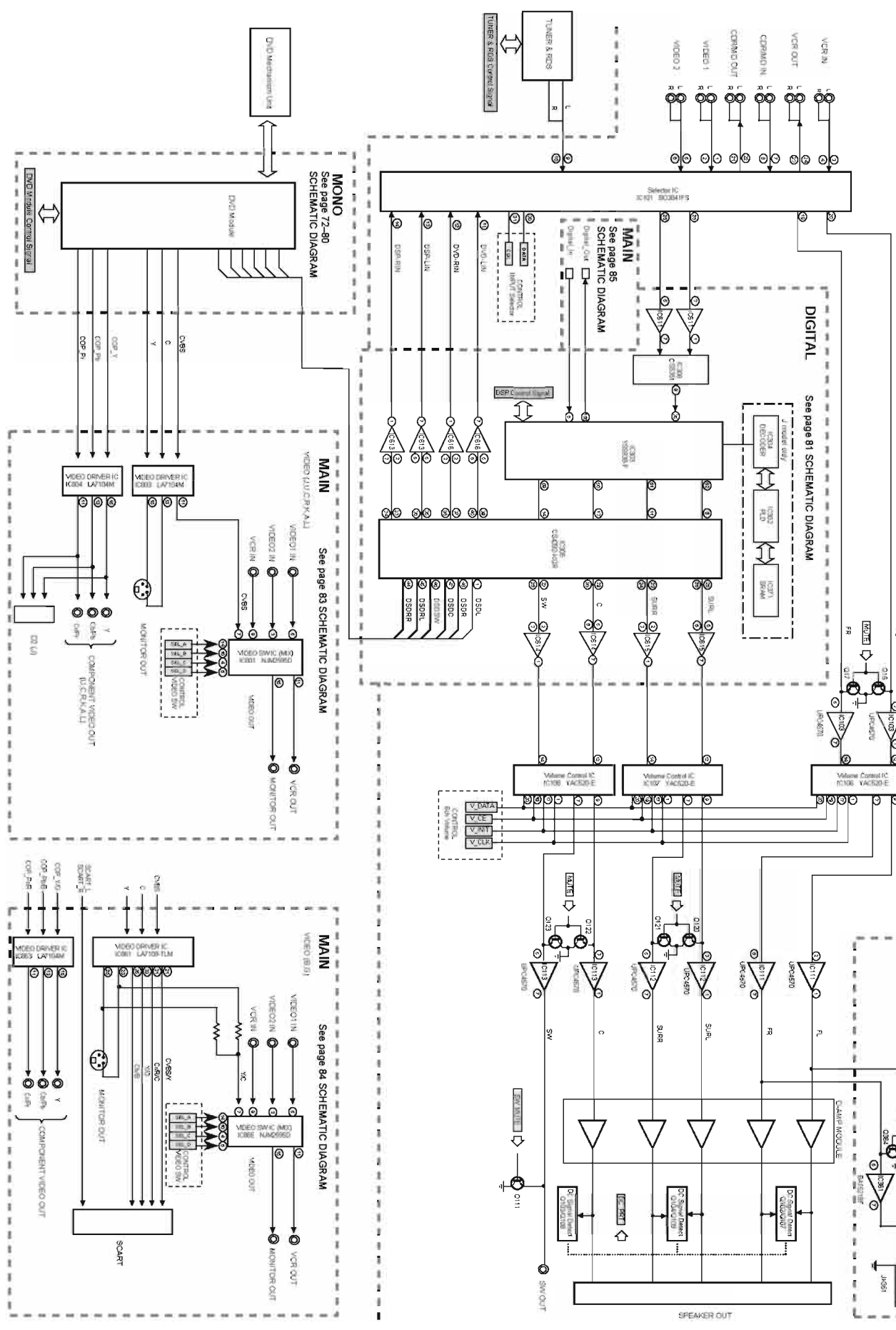

1

2

3

4

5

6

1

2

3

4

5

6

DVR-S200 BLOCK DIAGRAM (3/3) / ブロックダイアグラム

DIGITAL See page 81 SCHEMATIC DIAGRAM

SUB See page 86 SCHEMATIC DIAGRAM

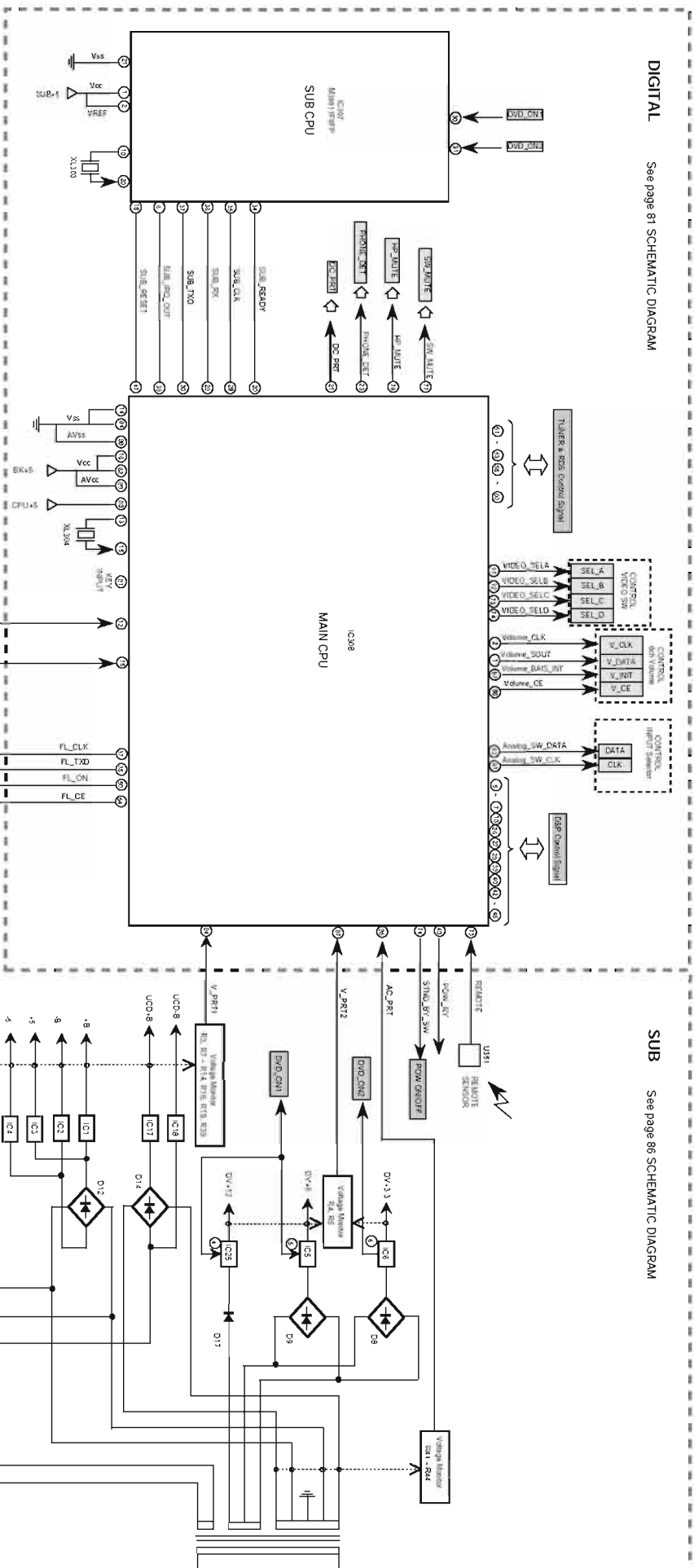

FL See page 87 SCHEMATIC DIAGRAM

DVR-S200 PRINTED CIRCUIT BOARD

FOR INFORMATION ONLY (NO SERVICE PARTS WILL BE AVAILABLE)

DVR-S200

MONO Board Testpoint View

The first digit of a component indicates the component type.
 1xxx : Connector 3xxx : Resistor 5xxx : Coil 7xxx : IC, Transistor, FET
 2xxx : Capacitor 4xxx : SMD Jumper 6xxx : Diode 9xxx : Wire Jumper

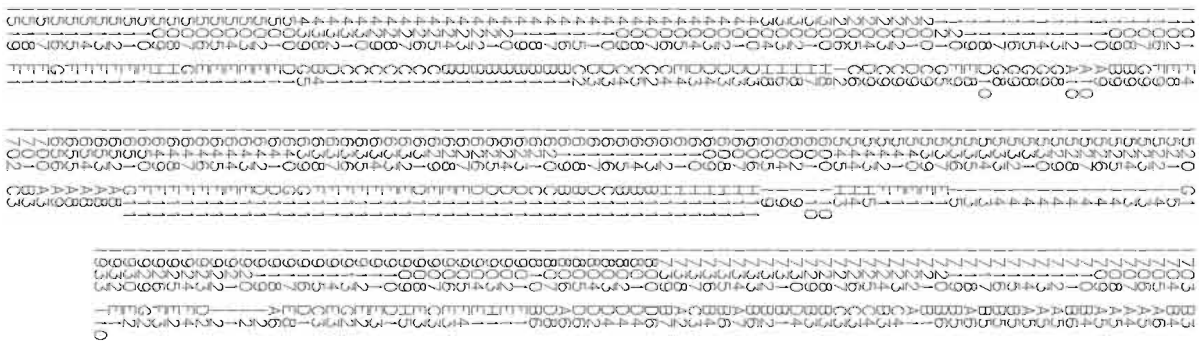
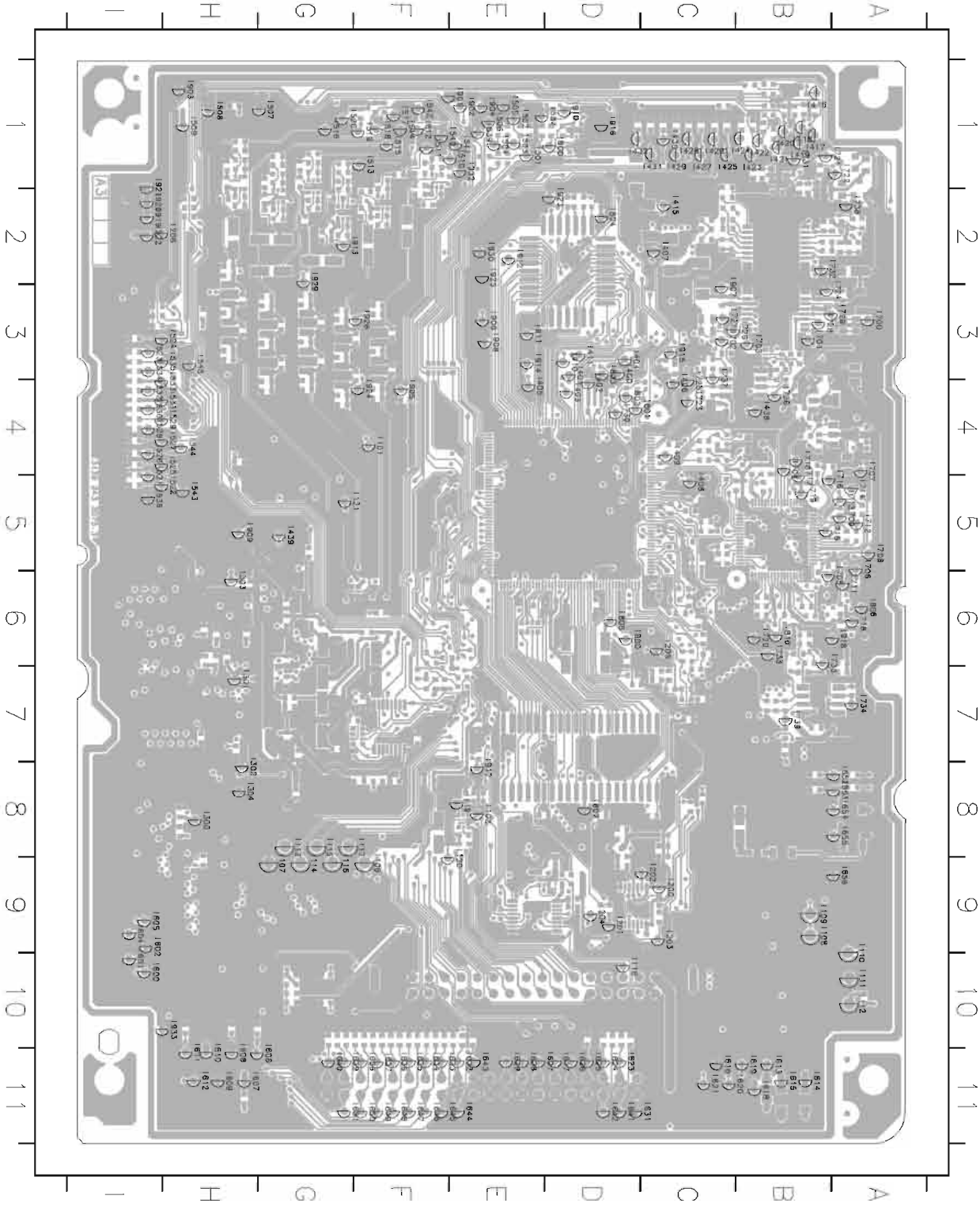

DVR-S200 PRINTED CIRCUIT BOARD

FOR INFORMATION ONLY (NO SERVICE PARTS WILL BE AVAILABLE)

DVR-S200

MONO Board Top View

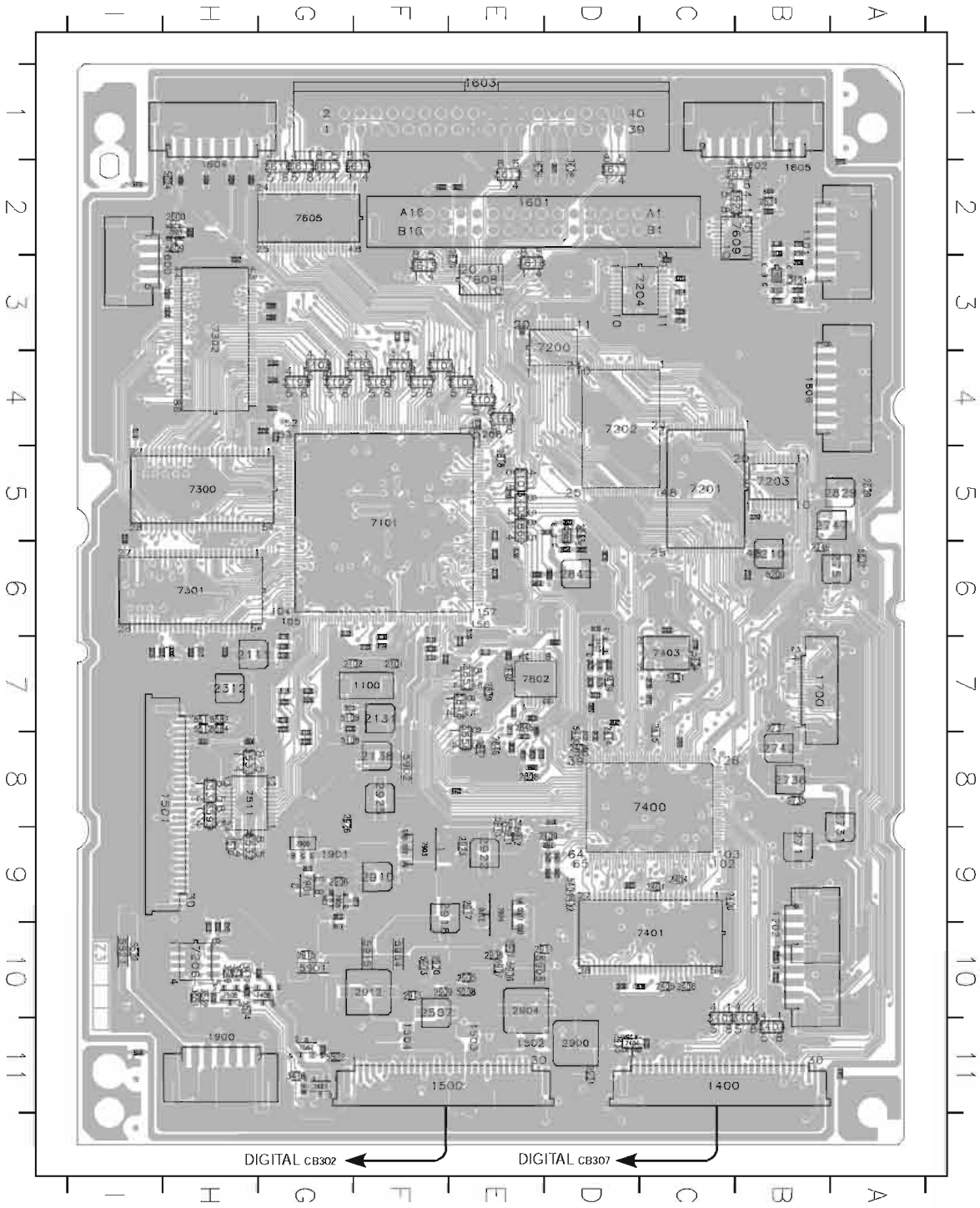

The first digit of a component indicates the component type.
 1xxx : Connector 3xxx : Resistor 5xxx : Coil 7xxx : IC, Transistor, FET
 2xxx : Capacitor 4xxx : SMD jumper 6xxx : Diode 9xxx : Wire jumper

DVR-S200 PRINTED CIRCUIT BOARD

FOR INFORMATION ONLY (NO SERVICE PARTS WILL BE AVAILABLE)

DVR-S200

MONO Board Bottom View

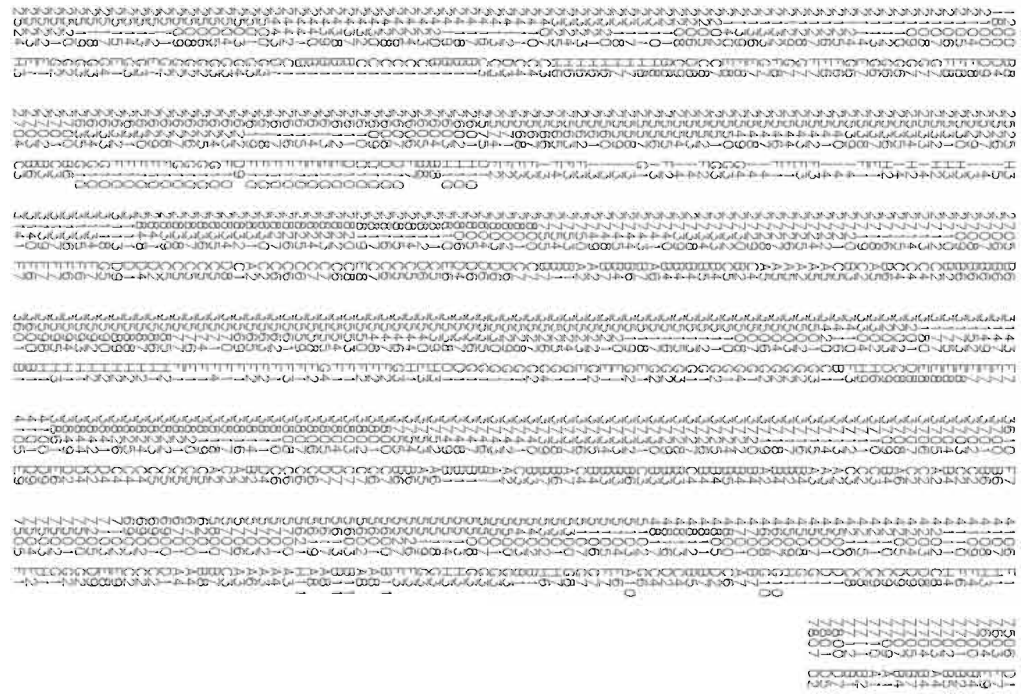
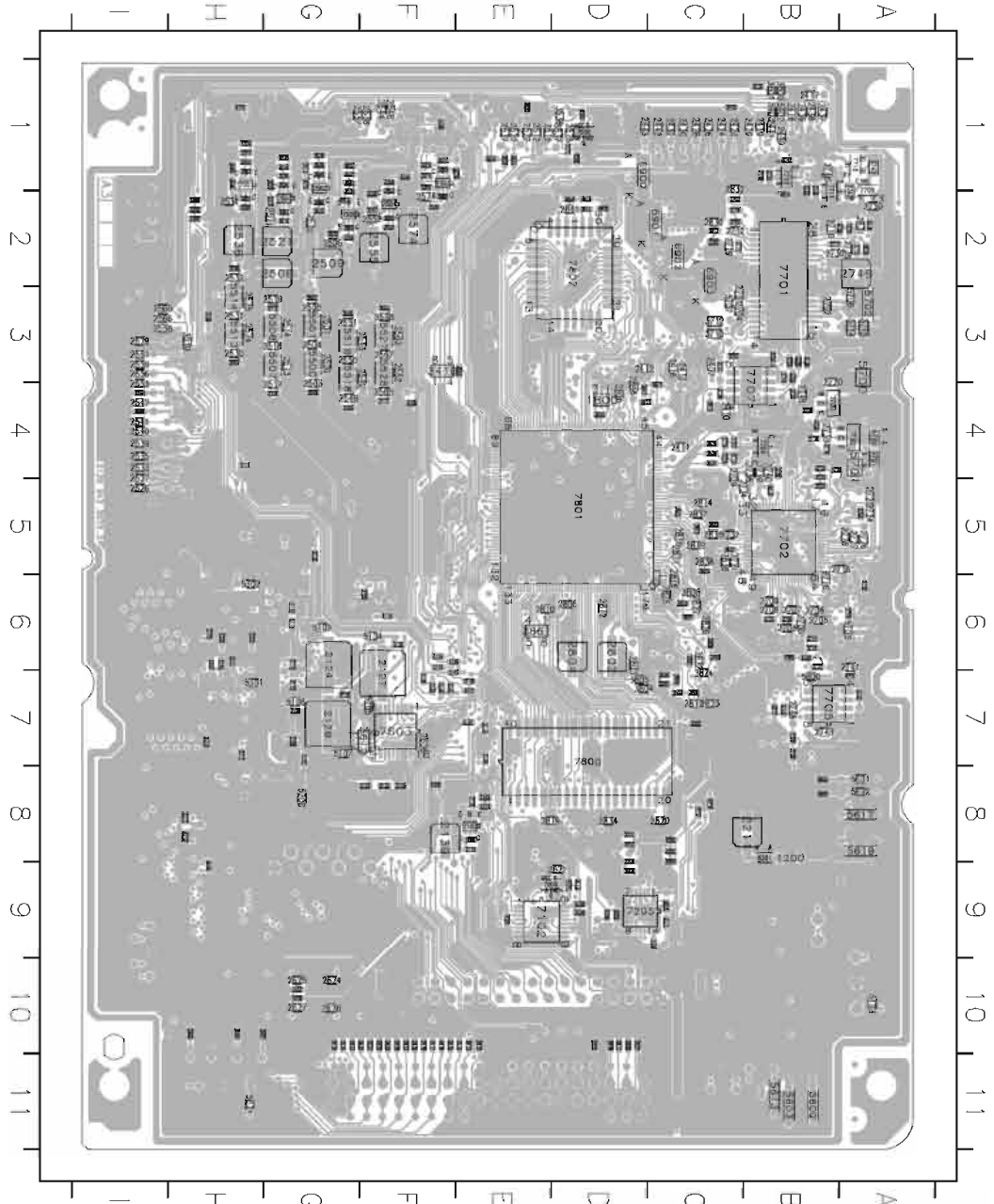

The first digit of a component indicates the component type.
 1xxx : Connector 3xxx : Resistor 5xxx : Coil 7xxx : IC, Transistor, FET
 2xxx : Capacitor 4xxx : SMD Jumper 6xxx : Diode 9xxx : Wire Jumper

DVR-S200 PRINTED CIRCUIT BOARD (Foil side)

DIGITAL P.C.B.

(Lead Type Device)

MONO 1400

MAIN (3) CE305 or MAIN (4) CE372

MONO 1500

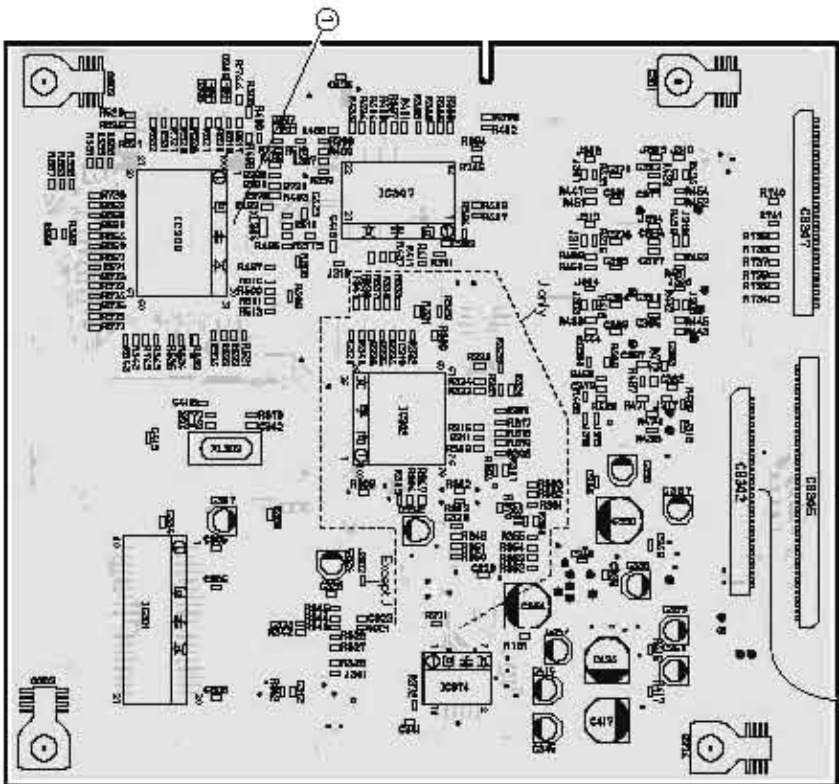

Point ① (Pin 13 of IC305)



Point ② (Pin 1 of IC303)



Point ③ (Pin 8 of IC318)



DVR-S200

DIGITAL P.C.B.

(Surface Mount Device)

MAIN (1) CE105

MAIN (1) CE105

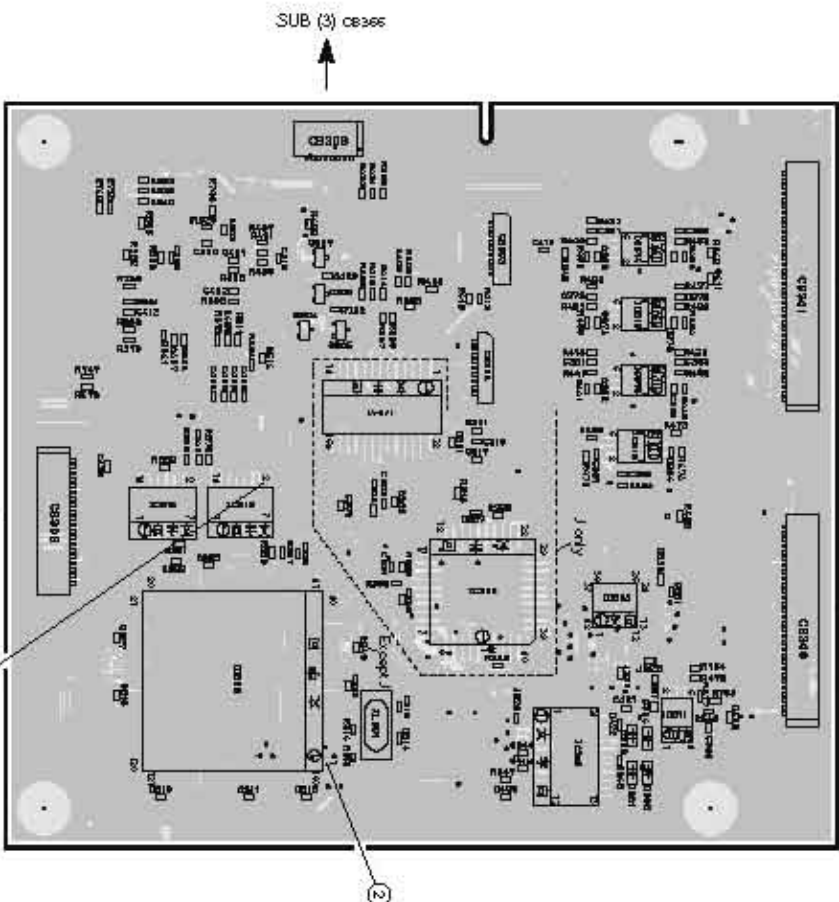

NOTE
The DIGITAL P.C.B. actually has a four-layer pattern structure (part face pattern, internal pattern 1, internal pattern 2 and solder face pattern) but it is shown as "part face pattern" + solder face pattern" in this diagram.

NOTE
DIGITAL P.C.B.は、4層パターン構造 (部品面パターン、内部パターン1、内部パターン2、ハンダ面パターン) ですが、この図では「部品面パターン」+「ハンダ面パターン」の構造として示されています。

■ DVR-S200 PRINTED CIRCUIT BOARD (Foil side)

DVR-S200

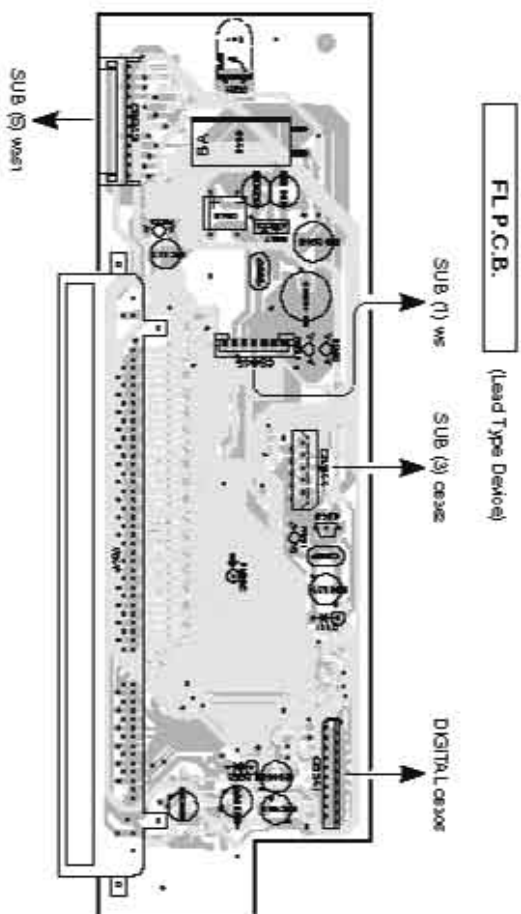

FL P.C.B. (Surface Mount Device)

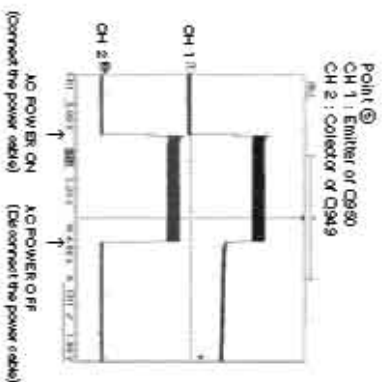
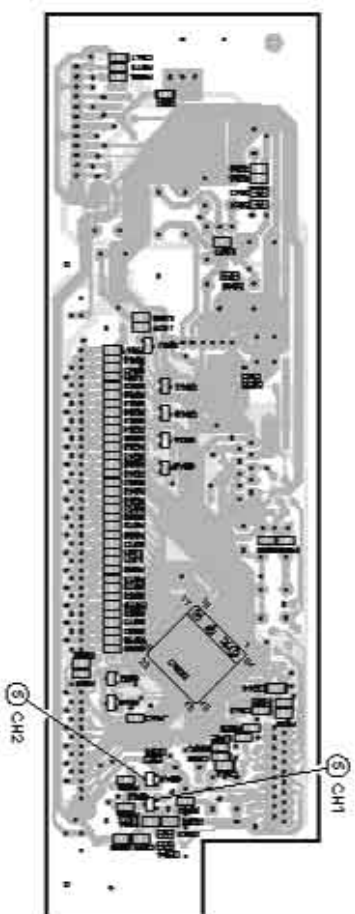

1
2
3
4
5
6

DVR-S200 PRINTED CIRCUIT BOARD (Foil side)

DVR-S200

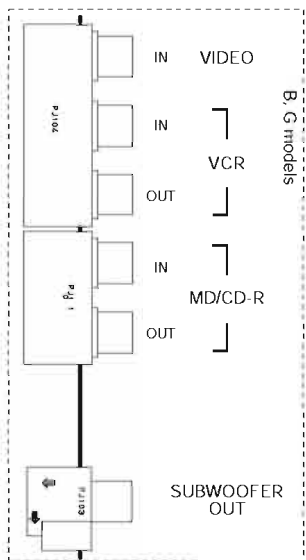

MAIN (1) P.C.B.

(Lead Type Device)

⊗ SPEAKERS ⊙

FRONT CENTER FRONT

SURROUND SURROUND

FAN

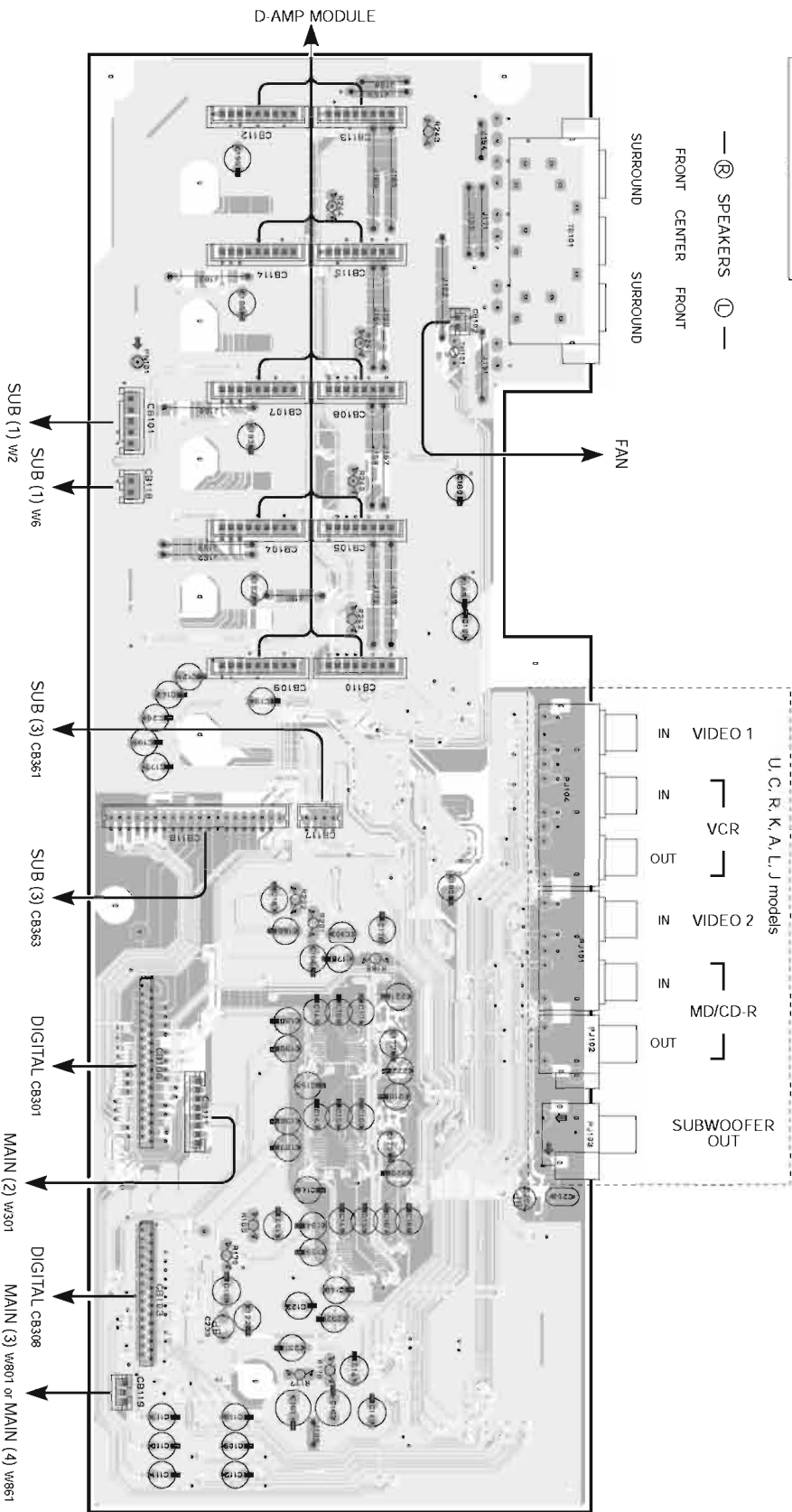

DVR-S200 PRINTED CIRCUIT BOARD (Foil side)

DVR-S200

MAIN (2) P.C.B.
(Lead Type Device)

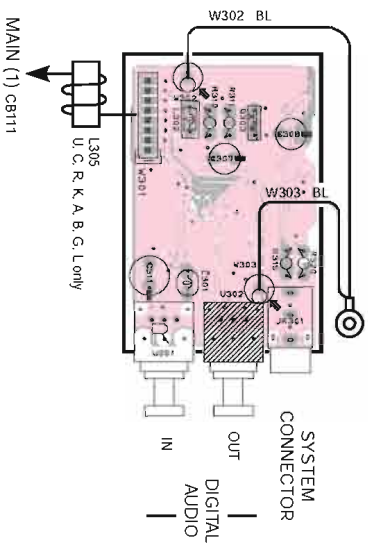

MAIN (2) P.C.B.
(Surface Mount Device)

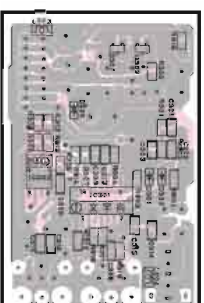

MAIN (1) P.C.B.
(Surface Mount Device)

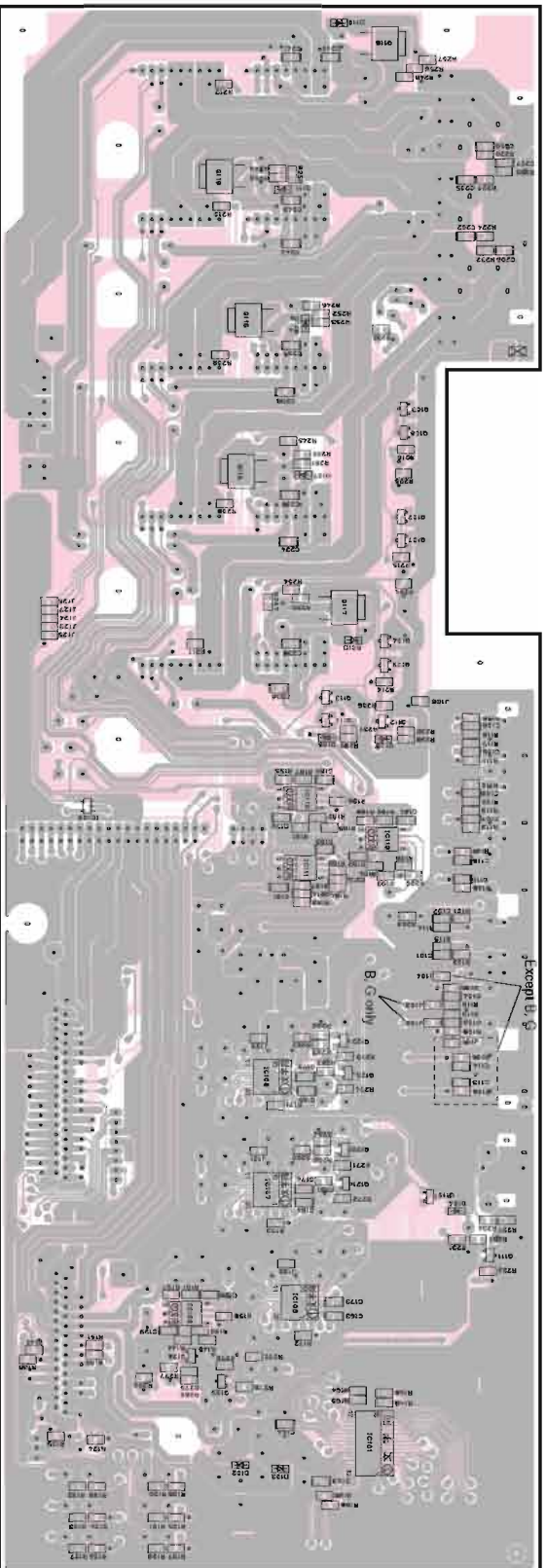

1

2

3

4

5

6

DVR-S200 PRINTED CIRCUIT BOARD (Foil side)

DVR-S200

• U, C, R, K, A, L, J models

MAIN (3) P.C.B. (Lead Type Device)

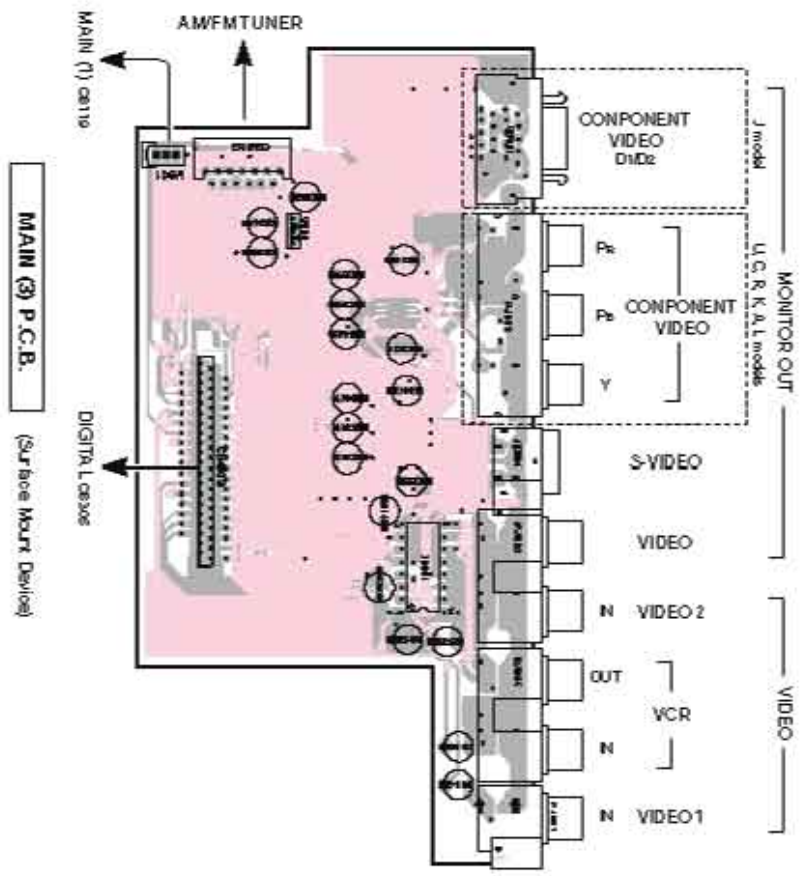

MAIN (3) P.C.B. (Surface Mount Device)

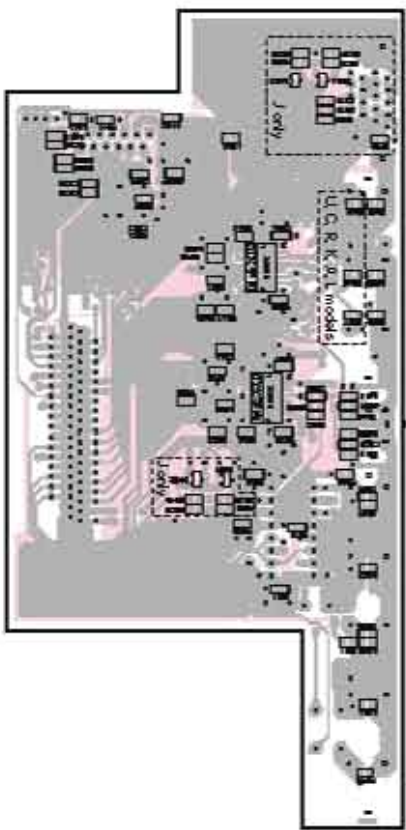

• B, G models

MAIN (4) P.C.B. (Lead Type Device)

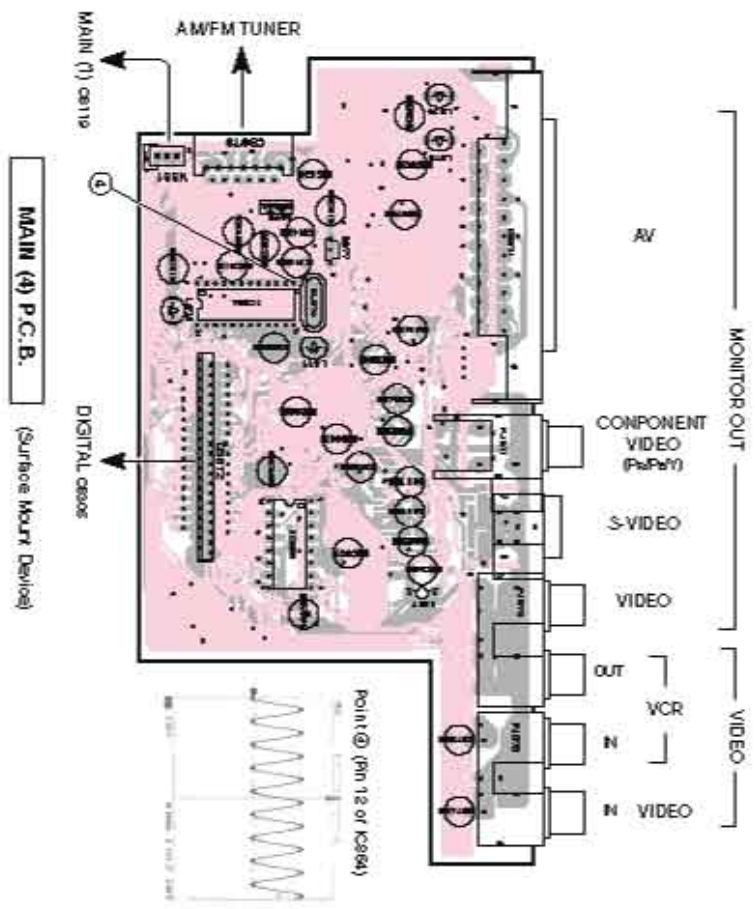

MAIN (4) P.C.B. (Surface Mount Device)

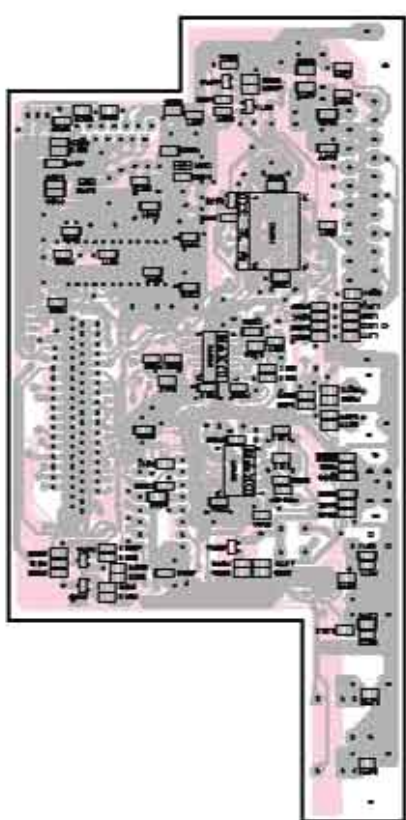

■ DVR-S200 PRINTED CIRCUIT BOARD (Foil side)

DVR-S200

SUB (1) P.C.B. (Lead Type Device)

SUB (1) P.C.B. (Surface Mount Device)

POWER CABLE

MAIN (1) CB101

MAIN (1) CB118

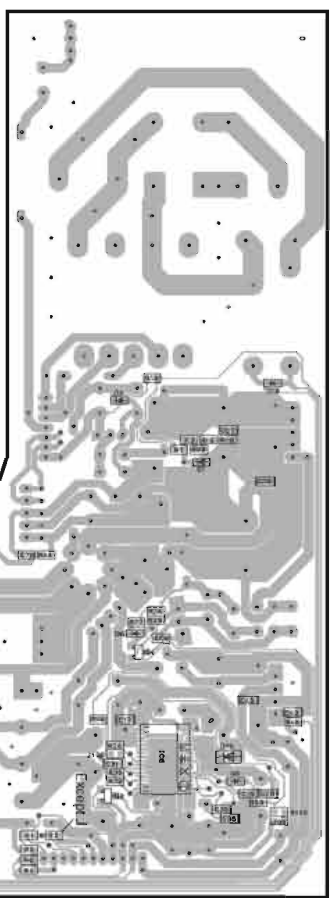
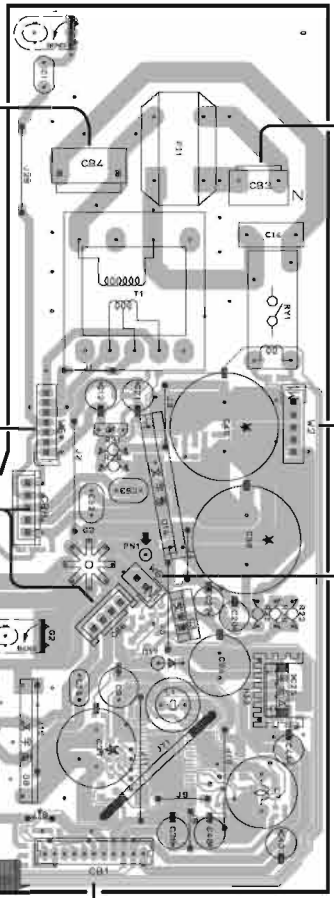

SUB (2) P.C.B. (Lead Type Device)

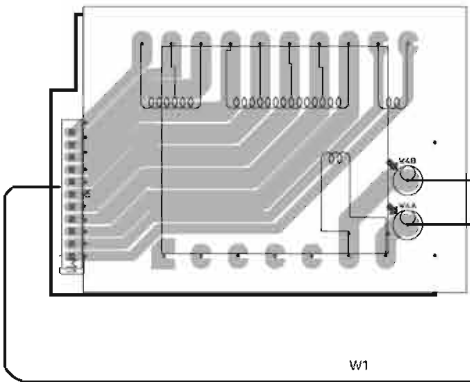

SUB (3) CB365

SUB (3) CB364

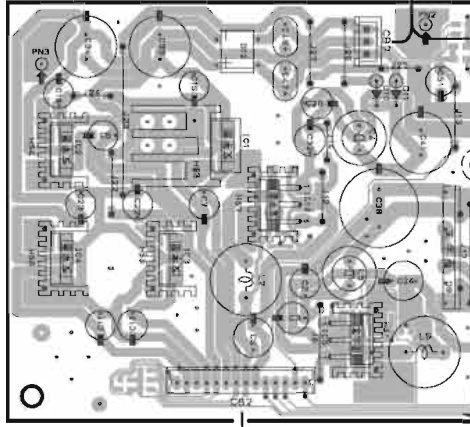

1

2

3

4

5

6

DVR-S200 PRINTED CIRCUIT BOARD (Foil side)

DVR-S200

SUB (3) P.C.B.
(Lead Type Device)

SUB (3) P.C.B.
(Surface Mount Device)

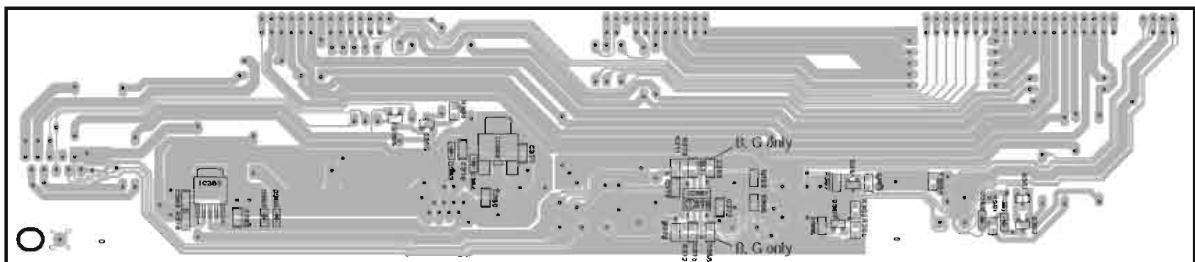
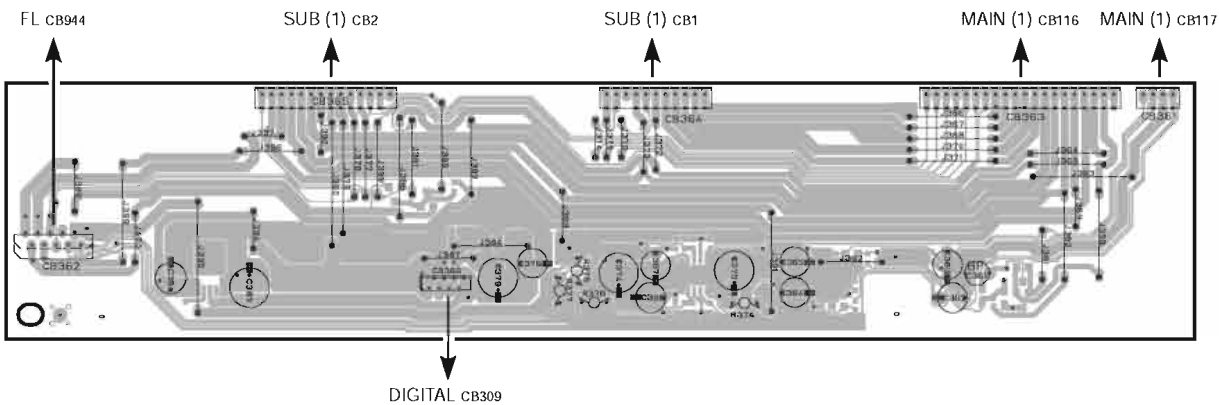

SUB (5) P.C.B.
(Lead Type Device)

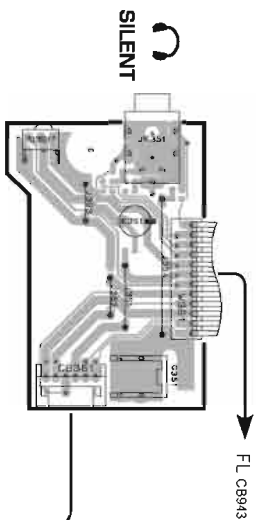

SUB (5) P.C.B.
(Surface Mount Device)

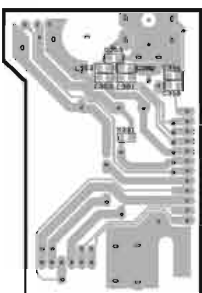

SUB (4) P.C.B.
(Lead Type Device)

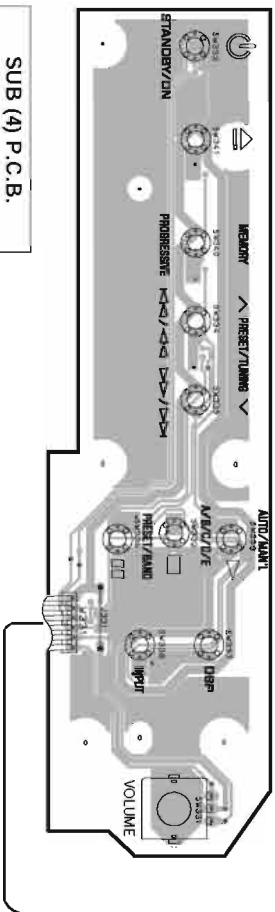

SUB (4) P.C.B.
(Surface Mount Device)

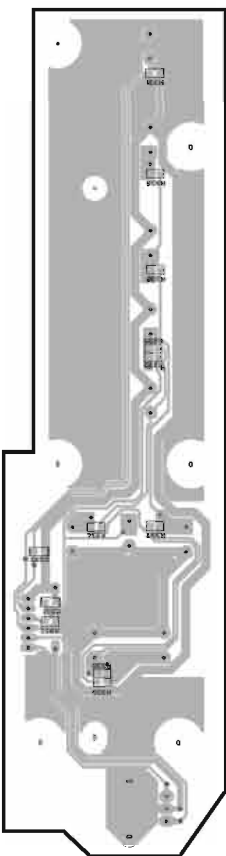

■ NX-SW200 PRINTED CIRCUIT BOARD (Foil side)

NX-SW200
MAIN (1) P.C.B.

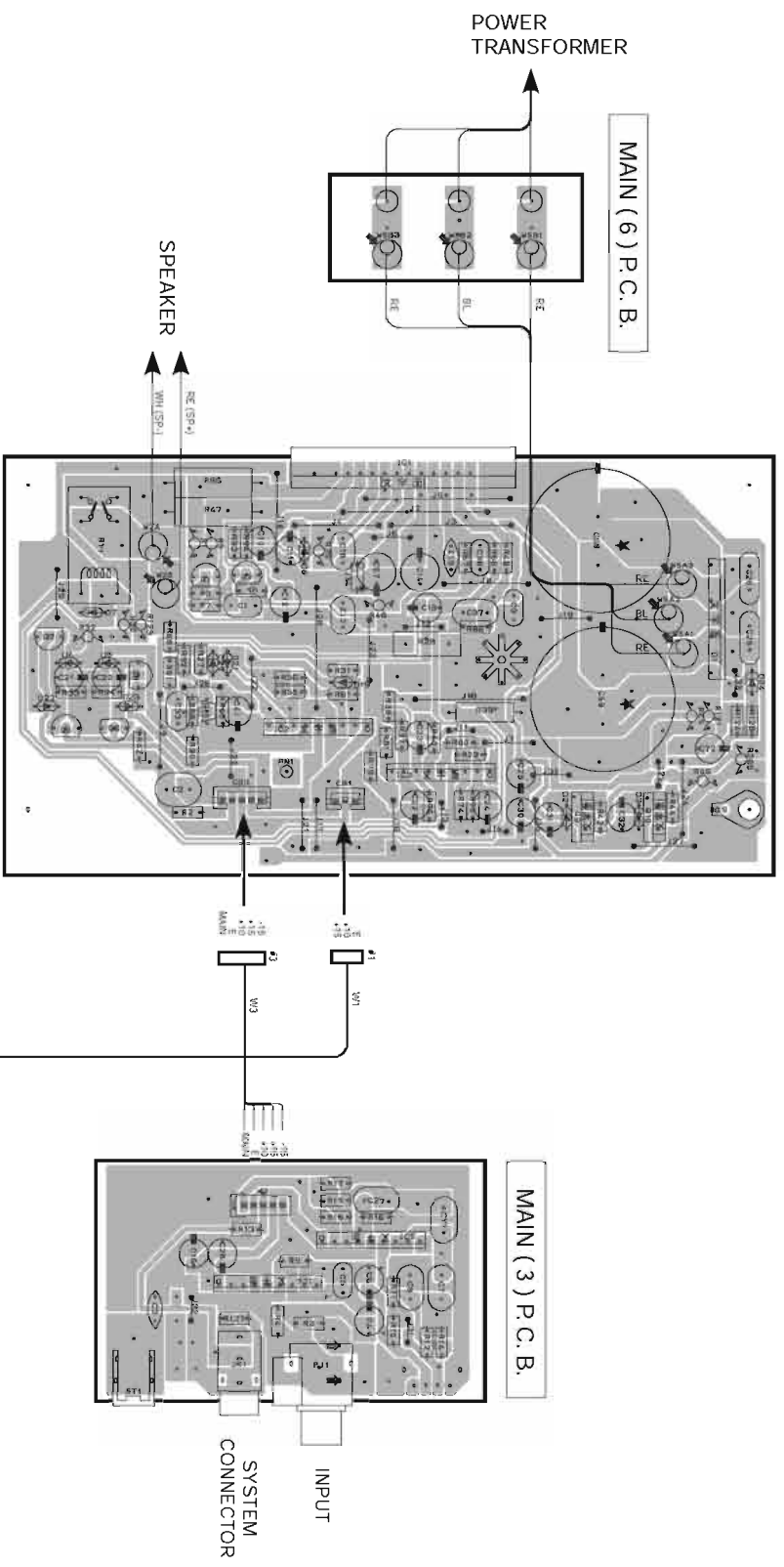

MAIN (6) P.C.B.

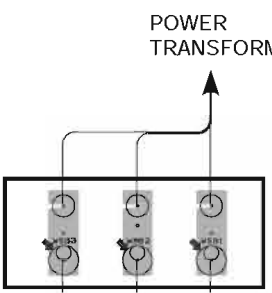

MAIN (7) P.C.B.

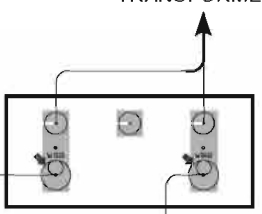

MAIN (2) P.C.B.

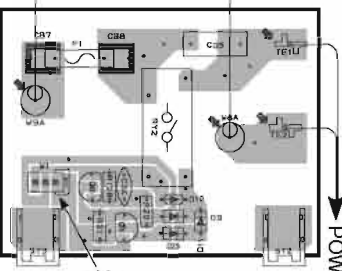

MAIN (3) P.C.B.

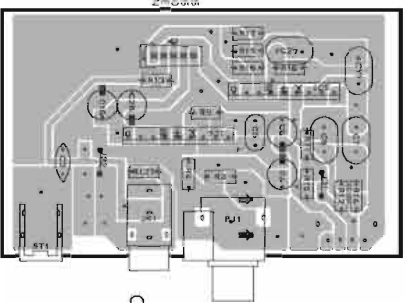

POWER TRANSFORMER

POWER TRANSFORMER

SPEAKER

POWER CABLE

INPUT
SYSTEM
CONNECTOR

1

2

3

4

5

6

DVR-S200 SCHEMATIC DIAGRAM (MONO 1/9)
 FOR INFORMATION ONLY (NO SERVICE PARTS WILL BE AVAILABLE)

M1 DVD DECODER

REF	MARKING	DESCRIPTION	QUANTITY
M1	DVD DECODER	DVD DECODER	1
M2	TO/FROM	TO/FROM	1
M3	TO/FROM	TO/FROM	1
M4	TO/FROM	TO/FROM	1
M5	TO/FROM	TO/FROM	1
M6	TO/FROM	TO/FROM	1
M7	TO/FROM	TO/FROM	1
M8	TO/FROM	TO/FROM	1
M9	TO/FROM	TO/FROM	1
M10	TO/FROM	TO/FROM	1
M11	TO/FROM	TO/FROM	1
M12	TO/FROM	TO/FROM	1
M13	TO/FROM	TO/FROM	1
M14	TO/FROM	TO/FROM	1
M15	TO/FROM	TO/FROM	1
M16	TO/FROM	TO/FROM	1
M17	TO/FROM	TO/FROM	1
M18	TO/FROM	TO/FROM	1
M19	TO/FROM	TO/FROM	1
M20	TO/FROM	TO/FROM	1
M21	TO/FROM	TO/FROM	1
M22	TO/FROM	TO/FROM	1
M23	TO/FROM	TO/FROM	1
M24	TO/FROM	TO/FROM	1
M25	TO/FROM	TO/FROM	1
M26	TO/FROM	TO/FROM	1
M27	TO/FROM	TO/FROM	1
M28	TO/FROM	TO/FROM	1
M29	TO/FROM	TO/FROM	1
M30	TO/FROM	TO/FROM	1
M31	TO/FROM	TO/FROM	1
M32	TO/FROM	TO/FROM	1
M33	TO/FROM	TO/FROM	1
M34	TO/FROM	TO/FROM	1
M35	TO/FROM	TO/FROM	1
M36	TO/FROM	TO/FROM	1
M37	TO/FROM	TO/FROM	1
M38	TO/FROM	TO/FROM	1
M39	TO/FROM	TO/FROM	1
M40	TO/FROM	TO/FROM	1
M41	TO/FROM	TO/FROM	1
M42	TO/FROM	TO/FROM	1
M43	TO/FROM	TO/FROM	1
M44	TO/FROM	TO/FROM	1
M45	TO/FROM	TO/FROM	1
M46	TO/FROM	TO/FROM	1
M47	TO/FROM	TO/FROM	1
M48	TO/FROM	TO/FROM	1
M49	TO/FROM	TO/FROM	1
M50	TO/FROM	TO/FROM	1
M51	TO/FROM	TO/FROM	1
M52	TO/FROM	TO/FROM	1
M53	TO/FROM	TO/FROM	1
M54	TO/FROM	TO/FROM	1
M55	TO/FROM	TO/FROM	1
M56	TO/FROM	TO/FROM	1
M57	TO/FROM	TO/FROM	1
M58	TO/FROM	TO/FROM	1
M59	TO/FROM	TO/FROM	1
M60	TO/FROM	TO/FROM	1
M61	TO/FROM	TO/FROM	1
M62	TO/FROM	TO/FROM	1
M63	TO/FROM	TO/FROM	1
M64	TO/FROM	TO/FROM	1
M65	TO/FROM	TO/FROM	1
M66	TO/FROM	TO/FROM	1
M67	TO/FROM	TO/FROM	1
M68	TO/FROM	TO/FROM	1
M69	TO/FROM	TO/FROM	1
M70	TO/FROM	TO/FROM	1
M71	TO/FROM	TO/FROM	1
M72	TO/FROM	TO/FROM	1
M73	TO/FROM	TO/FROM	1
M74	TO/FROM	TO/FROM	1
M75	TO/FROM	TO/FROM	1
M76	TO/FROM	TO/FROM	1
M77	TO/FROM	TO/FROM	1
M78	TO/FROM	TO/FROM	1
M79	TO/FROM	TO/FROM	1
M80	TO/FROM	TO/FROM	1
M81	TO/FROM	TO/FROM	1
M82	TO/FROM	TO/FROM	1
M83	TO/FROM	TO/FROM	1
M84	TO/FROM	TO/FROM	1
M85	TO/FROM	TO/FROM	1
M86	TO/FROM	TO/FROM	1
M87	TO/FROM	TO/FROM	1
M88	TO/FROM	TO/FROM	1
M89	TO/FROM	TO/FROM	1
M90	TO/FROM	TO/FROM	1
M91	TO/FROM	TO/FROM	1
M92	TO/FROM	TO/FROM	1
M93	TO/FROM	TO/FROM	1
M94	TO/FROM	TO/FROM	1
M95	TO/FROM	TO/FROM	1
M96	TO/FROM	TO/FROM	1
M97	TO/FROM	TO/FROM	1
M98	TO/FROM	TO/FROM	1
M99	TO/FROM	TO/FROM	1
M100	TO/FROM	TO/FROM	1

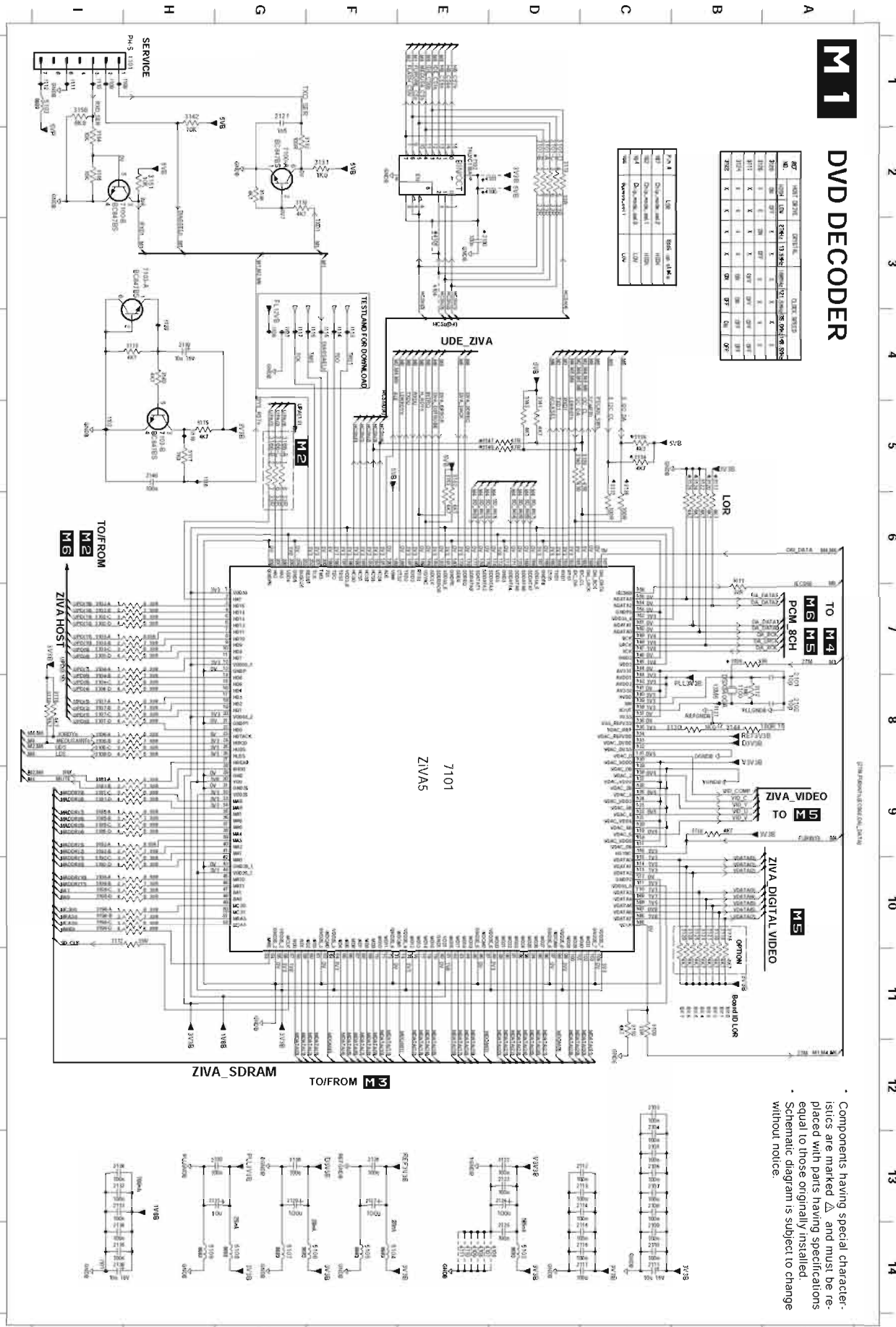

The first digit of a component indicates the component type.
 1xxx : Connector 3xxx : Resistor 5xxx : IC, Transistor, FET
 2xxx : Capacitor 4xxx : SMD Jumper 6xxx : Diode 9xxx : Wire Jumper

Components having special characteristics are marked Δ and must be replaced with parts having specifications equal to those originally installed.
 Schematic diagram is subject to change without notice.

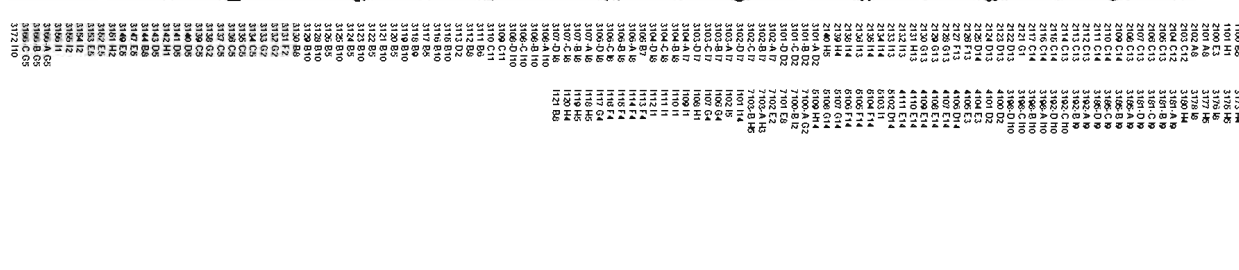

DVR-S200 SCHEMATIC DIAGRAM (MONO 2/9)
 FOR INFORMATION ONLY (NO SERVICE PARTS WILL BE AVAILABLE)

M2 FLASH MEMORY

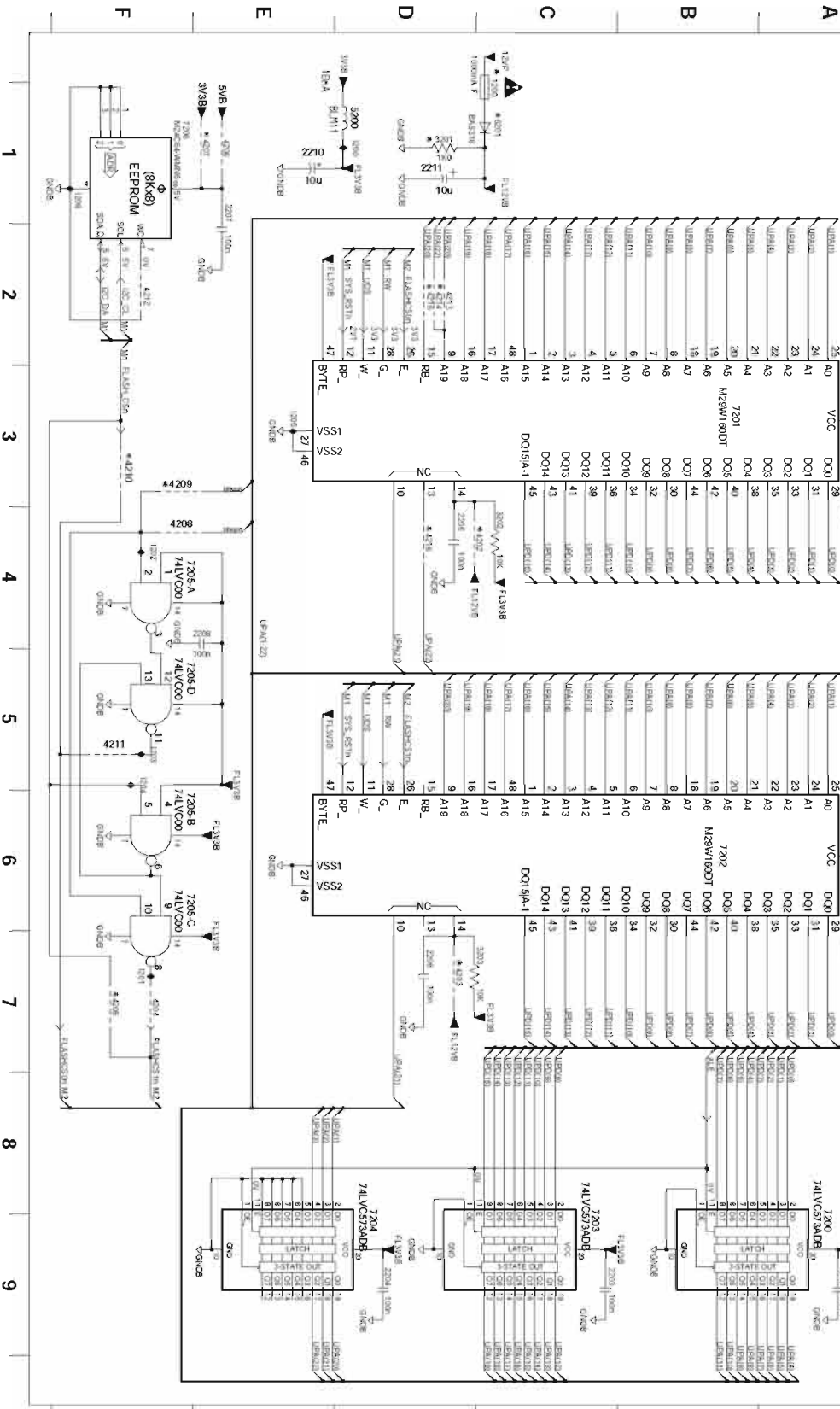

The first digit of a component indicates the component type.
 1xxx : Connector 3xxx : Resistor 5xxx : Coil 7xxx : IC, Transistor, FET
 2xxx : Capacitor 4xxx : SMD jumper 6xxx : Diode 9xxx : Wire jumper

- Components having special characteristics are marked **▲** and must be replaced with parts having specifications equal to those originally installed.
- Schematic diagram is subject to change without notice.

FLASH TYPE	18bits	32bits	64bits
MODEL	AK0130	AK0200	AK0210
MANUFACTURING METHOD	MEMORIE	MEMORIE	MEMORIE
LIGHT	MEMORIE	MEMORIE	MEMORIE

ALPHA	1.1.100	1.1.300	1.1.600	1.1.900	2.1.100	200 - 1.100
0	0	0	0	0	0	0
1	1	1	1	1	1	1
2	2	2	2	2	2	2
3	3	3	3	3	3	3
4	4	4	4	4	4	4
5	5	5	5	5	5	5
6	6	6	6	6	6	6
7	7	7	7	7	7	7
8	8	8	8	8	8	8
9	9	9	9	9	9	9

FLASH CS		
FLASH CS	FLASH CS	FLASH CS
1	1	1
2	2	2
3	3	3
4	4	4
5	5	5
6	6	6
7	7	7
8	8	8
9	9	9

■ DVR-S200 SCHEMATIC DIAGRAM (MONO 3/9)
 FOR INFORMATION ONLY (NO SERVICE PARTS WILL BE AVAILABLE)

M3 ZIVA SDRAM

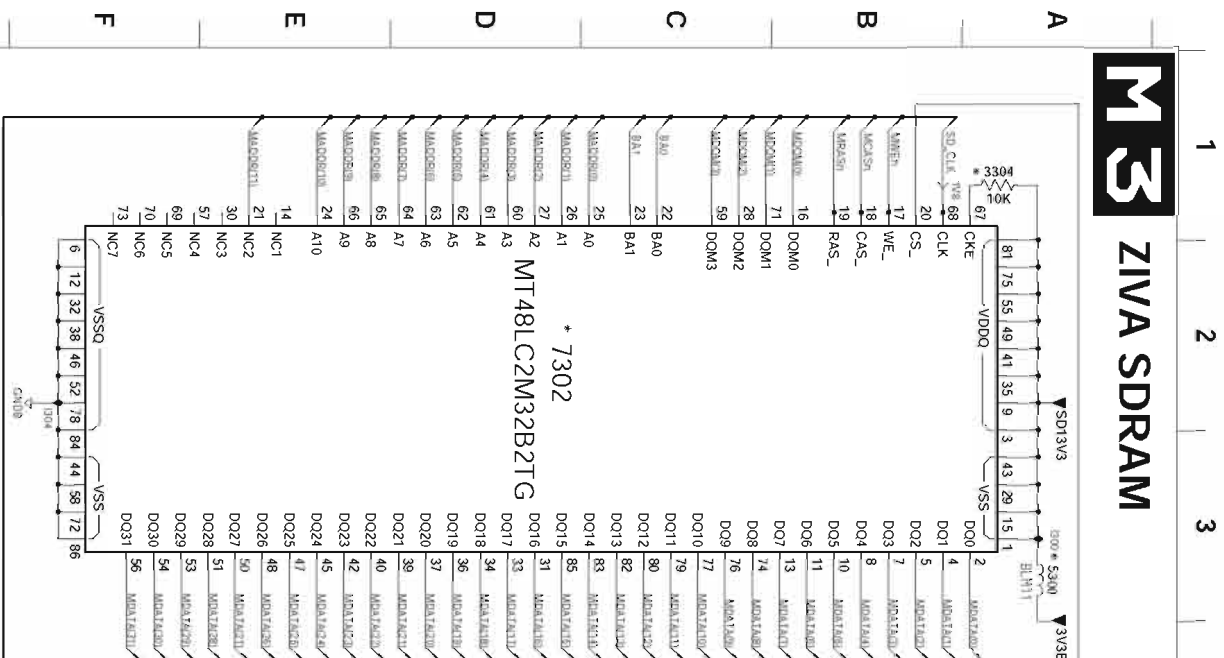

The first digit of a component indicates the component type.
 1xxx : Connector 3xxx : Resistor 5xxx : IC, Transistor, FET
 2xxx : Capacitor 4xxx : SMD Jumper 6xxx : Diode 9xxx : Wire Jumper

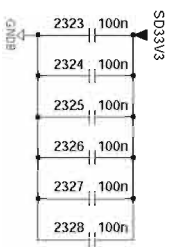
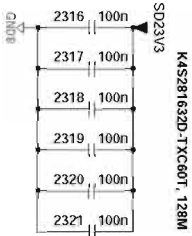
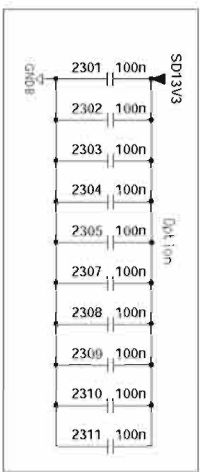

ZIVA_SDRAM
 TO/FROM M1

• Components having special characteristics are marked Δ and must be replaced with parts having specifications equal to those originally installed.
 • Schematic diagram is subject to change without notice.

DVR-S200 SCHEMATIC DIAGRAM (MONO 4/9)
 FOR INFORMATION ONLY (NO SERVICE PARTS WILL BE AVAILABLE)

M4 FUREORE AND SACD INTERFACE

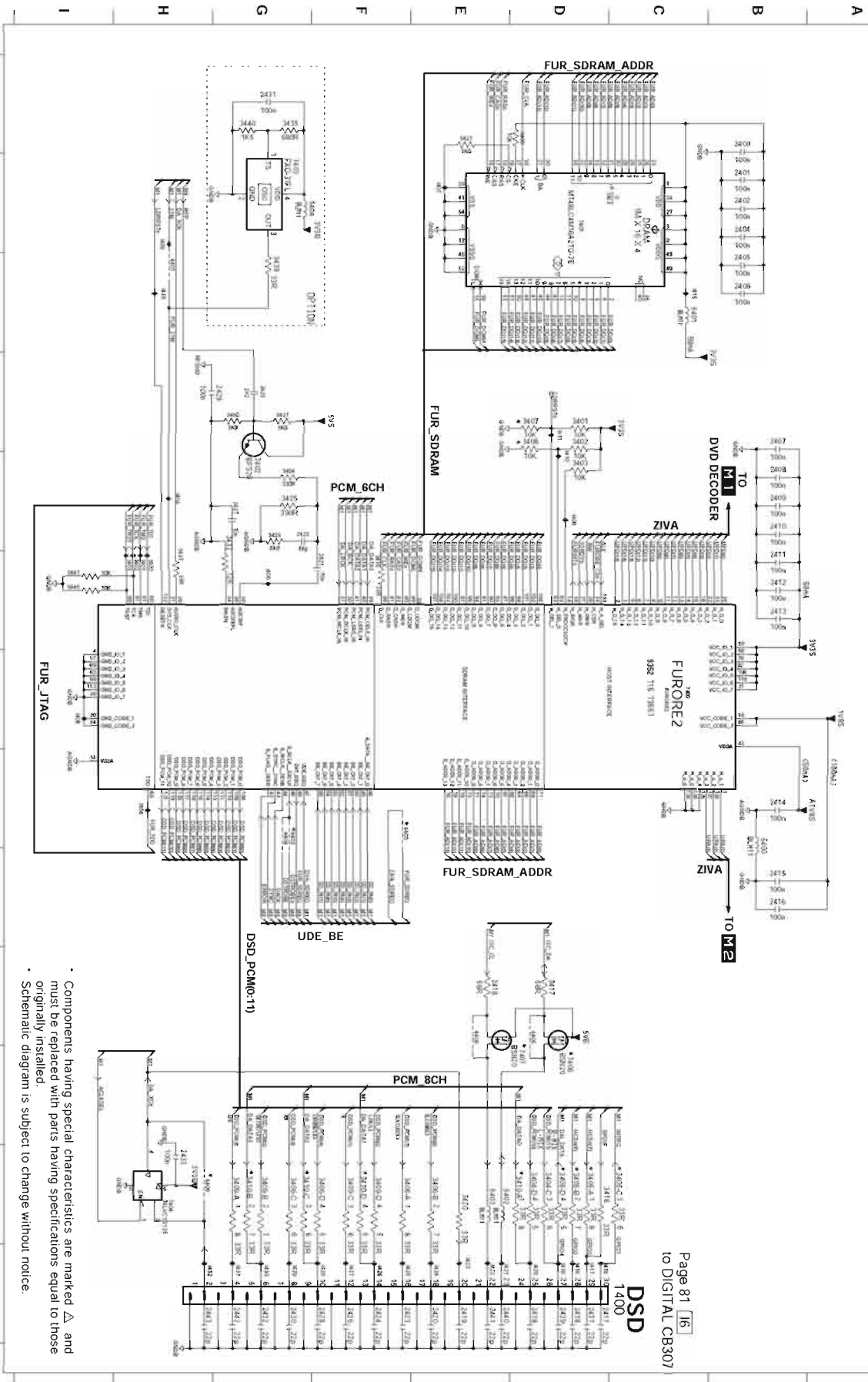

Page 81 16
 to DIGITAL CB307

The first digit of a component indicates the component type.
 1xxx : Connector 3xxx : Resistor 5xxx : Coil
 2xxx : Capacitor 4xxx : SMD jumper 6xxx : Diode 9xxx : Wire jumper

- Components having special characteristics are marked Δ and must be replaced with parts having specifications equal to those originally installed.
- Schematic diagram is subject to change without notice.

1400 C13	1400 C5
2801 B2	1410 D5
2801 B3	1415 C4
2805 B3	1416 D13
2806 B3	1417 D11
2806 B5	1418 D13
2806 B5	1419 D13
2806 B5	1420 D13
2806 B5	1421 D13
2806 B5	1422 E13
2806 B5	1423 E13
2806 B5	1424 E13
2806 B5	1425 E13
2806 B5	1426 E13
2806 B5	1427 E13
2806 B5	1428 E13
2806 B5	1429 E13
2806 B5	1430 E13
2806 B5	1431 E13
2806 B5	1432 E13
2806 B5	1433 E13
2806 B5	1434 E13
2806 B5	1435 E13
2806 B5	1436 E13
2806 B5	1437 E13
2806 B5	1438 E13
2806 B5	1439 E13
2806 B5	1440 E13
2806 B5	1441 E13
2806 B5	1442 E13
2806 B5	1443 E13
2806 B5	1444 E13
2806 B5	1445 E13
2806 B5	1446 E13
2806 B5	1447 E13
2806 B5	1448 E13
2806 B5	1449 E13
2806 B5	1450 E13
2806 B5	1451 E13
2806 B5	1452 E13
2806 B5	1453 E13
2806 B5	1454 E13
2806 B5	1455 E13
2806 B5	1456 E13
2806 B5	1457 E13
2806 B5	1458 E13
2806 B5	1459 E13
2806 B5	1460 E13
2806 B5	1461 E13
2806 B5	1462 E13
2806 B5	1463 E13
2806 B5	1464 E13
2806 B5	1465 E13
2806 B5	1466 E13
2806 B5	1467 E13
2806 B5	1468 E13
2806 B5	1469 E13
2806 B5	1470 E13
2806 B5	1471 E13
2806 B5	1472 E13
2806 B5	1473 E13
2806 B5	1474 E13
2806 B5	1475 E13
2806 B5	1476 E13
2806 B5	1477 E13
2806 B5	1478 E13
2806 B5	1479 E13
2806 B5	1480 E13
2806 B5	1481 E13
2806 B5	1482 E13
2806 B5	1483 E13
2806 B5	1484 E13
2806 B5	1485 E13
2806 B5	1486 E13
2806 B5	1487 E13
2806 B5	1488 E13
2806 B5	1489 E13
2806 B5	1490 E13
2806 B5	1491 E13
2806 B5	1492 E13
2806 B5	1493 E13
2806 B5	1494 E13
2806 B5	1495 E13
2806 B5	1496 E13
2806 B5	1497 E13
2806 B5	1498 E13
2806 B5	1499 E13
2806 B5	1500 E13

DVR-S200 SCHEMATIC DIAGRAM (MONO 5/9)
FOR INFORMATION ONLY (NO SERVICE PARTS WILL BE AVAILABLE)

MS VIDEO FILTER - AV I/F

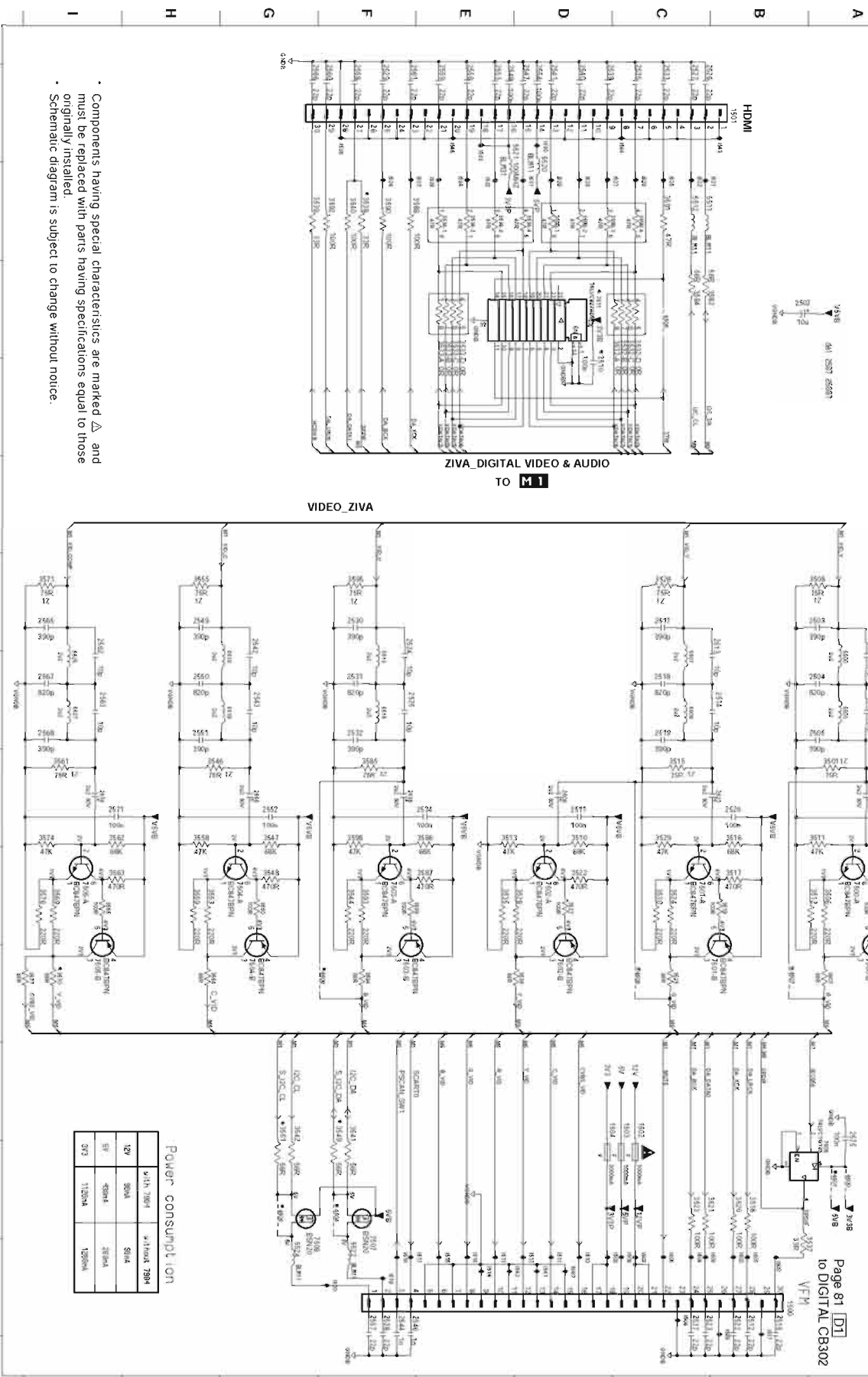

Components having special characteristics are marked Δ and must be replaced with parts having specifications equal to those originally installed.
 Schematic diagram is subject to change without notice.

The first digit of a component indicates the component type.
 1xxx : Connector 3xxx : Resistor 5xxx : IC, Transistor, FET
 2xxx : Capacitor 4xxx : SMD Jumper 6xxx : Diode 9xxx : Wire Jumper

Power consumption

V1FB	V2FB	V3FB	V4FB	V5FB
12V	30mA	30mA	30mA	30mA
5V	400mA	200mA	200mA	200mA
3.3V	1200mA	1200mA	1200mA	1200mA

DVR-S200 SCHEMATIC DIAGRAM (MONO 6/9)
FOR INFORMATION ONLY (NO SERVICE PARTS WILL BE AVAILABLE)

M6 **DIGITAL INPUT - HOST I/F - ATAPI I/F - E-LINK**

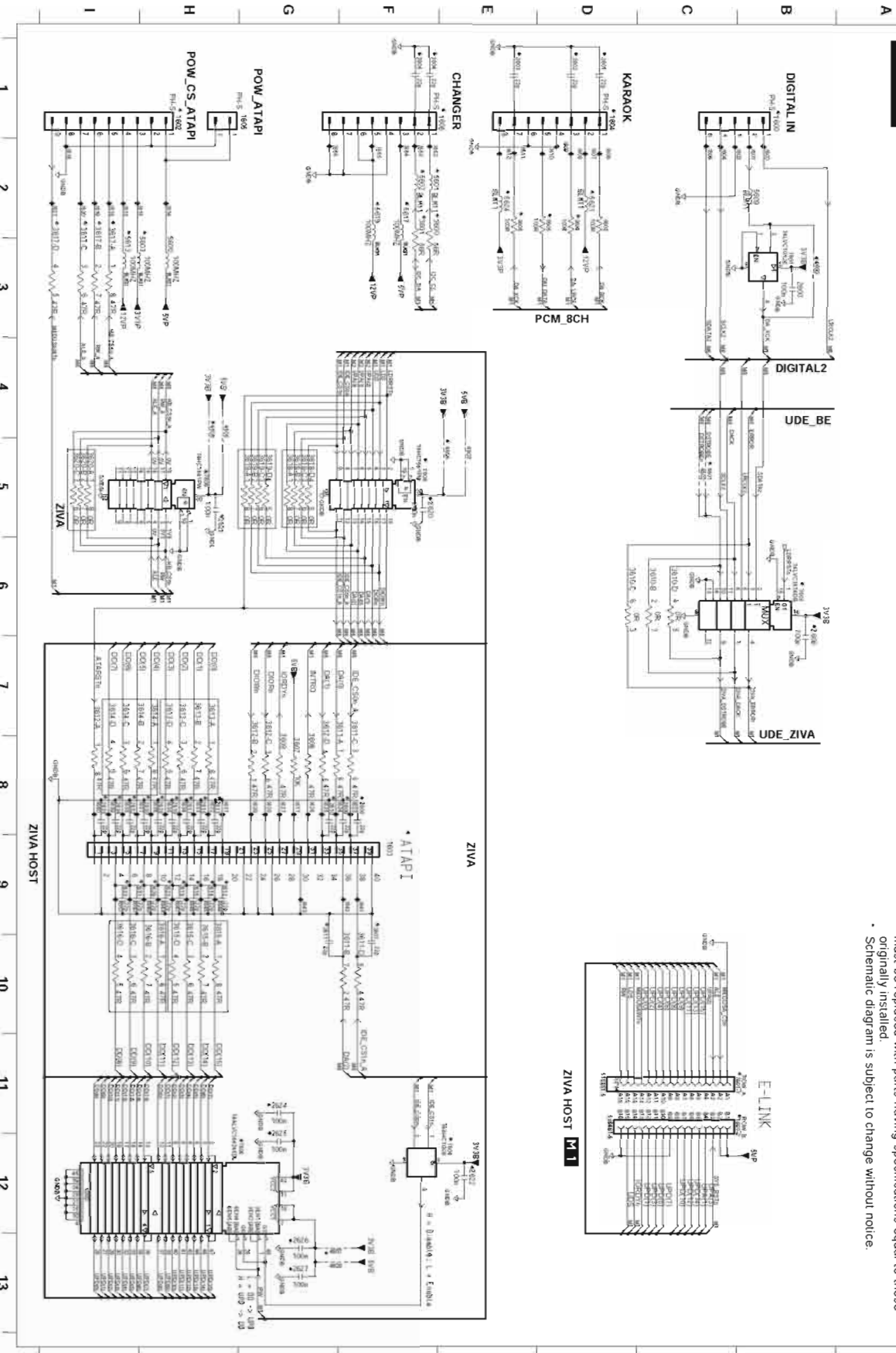

The first digit of a component indicates the component type.
 1xxx : Connector 3xxx : Resistor 5xxx : Coil 7xxx : IC, Transistor, FET
 2xxx : Capacitor 4xxx : SMD jumper 6xxx : Diode 9xxx : Wire jumper

- Components having special characteristics are marked Δ and must be replaced with parts having specifications equal to those originally installed.
- Schematic diagram is subject to change without notice.

1800 F1	5241 D2
1801 C1	5242 E2
1802 H4	7004 A12
1804 D1	7005 C12
1805 C1	7006 F1
1806 F1	7007 B1
1807 D1	7008 E1
1808 B3	7009 E2
1809 E1	7010 E2
1810 E1	7011 E2
1811 E1	7012 E2
1812 E1	7013 E2
1813 E1	7014 E2
1814 E1	7015 E2
1815 E1	7016 E2
1816 E1	7017 E2
1817 E1	7018 E2
1818 E1	7019 E2
1819 E1	7020 E2
1820 E1	7021 E2
1821 E1	7022 E2
1822 E1	7023 E2
1823 E1	7024 E2
1824 E1	7025 E2
1825 E1	7026 E2
1826 E1	7027 E2
1827 E1	7028 E2
1828 E1	7029 E2
1829 E1	7030 E2
1830 E1	7031 E2
1831 E1	7032 E2
1832 E1	7033 E2
1833 E1	7034 E2
1834 E1	7035 E2
1835 E1	7036 E2
1836 E1	7037 E2
1837 E1	7038 E2
1838 E1	7039 E2
1839 E1	7040 E2
1840 E1	7041 E2
1841 E1	7042 E2
1842 E1	7043 E2
1843 E1	7044 E2
1844 E1	7045 E2
1845 E1	7046 E2
1846 E1	7047 E2
1847 E1	7048 E2
1848 E1	7049 E2
1849 E1	7050 E2
1850 E1	7051 E2
1851 E1	7052 E2
1852 E1	7053 E2
1853 E1	7054 E2
1854 E1	7055 E2
1855 E1	7056 E2
1856 E1	7057 E2
1857 E1	7058 E2
1858 E1	7059 E2
1859 E1	7060 E2
1860 E1	7061 E2
1861 E1	7062 E2
1862 E1	7063 E2
1863 E1	7064 E2
1864 E1	7065 E2
1865 E1	7066 E2
1866 E1	7067 E2
1867 E1	7068 E2
1868 E1	7069 E2
1869 E1	7070 E2
1870 E1	7071 E2
1871 E1	7072 E2
1872 E1	7073 E2
1873 E1	7074 E2
1874 E1	7075 E2
1875 E1	7076 E2
1876 E1	7077 E2
1877 E1	7078 E2
1878 E1	7079 E2
1879 E1	7080 E2
1880 E1	7081 E2
1881 E1	7082 E2
1882 E1	7083 E2
1883 E1	7084 E2
1884 E1	7085 E2
1885 E1	7086 E2
1886 E1	7087 E2
1887 E1	7088 E2
1888 E1	7089 E2
1889 E1	7090 E2
1890 E1	7091 E2
1891 E1	7092 E2
1892 E1	7093 E2
1893 E1	7094 E2
1894 E1	7095 E2
1895 E1	7096 E2
1896 E1	7097 E2
1897 E1	7098 E2
1898 E1	7099 E2
1899 E1	7100 E2

DVR-S200 SCHEMATIC DIAGRAM (MONO 7/9)
 FOR INFORMATION ONLY (NO SERVICE PARTS WILL BE AVAILABLE)

M7 LASER CONTROL

1 2 3 4 5 6 7 8 9 10 11 12 13 14

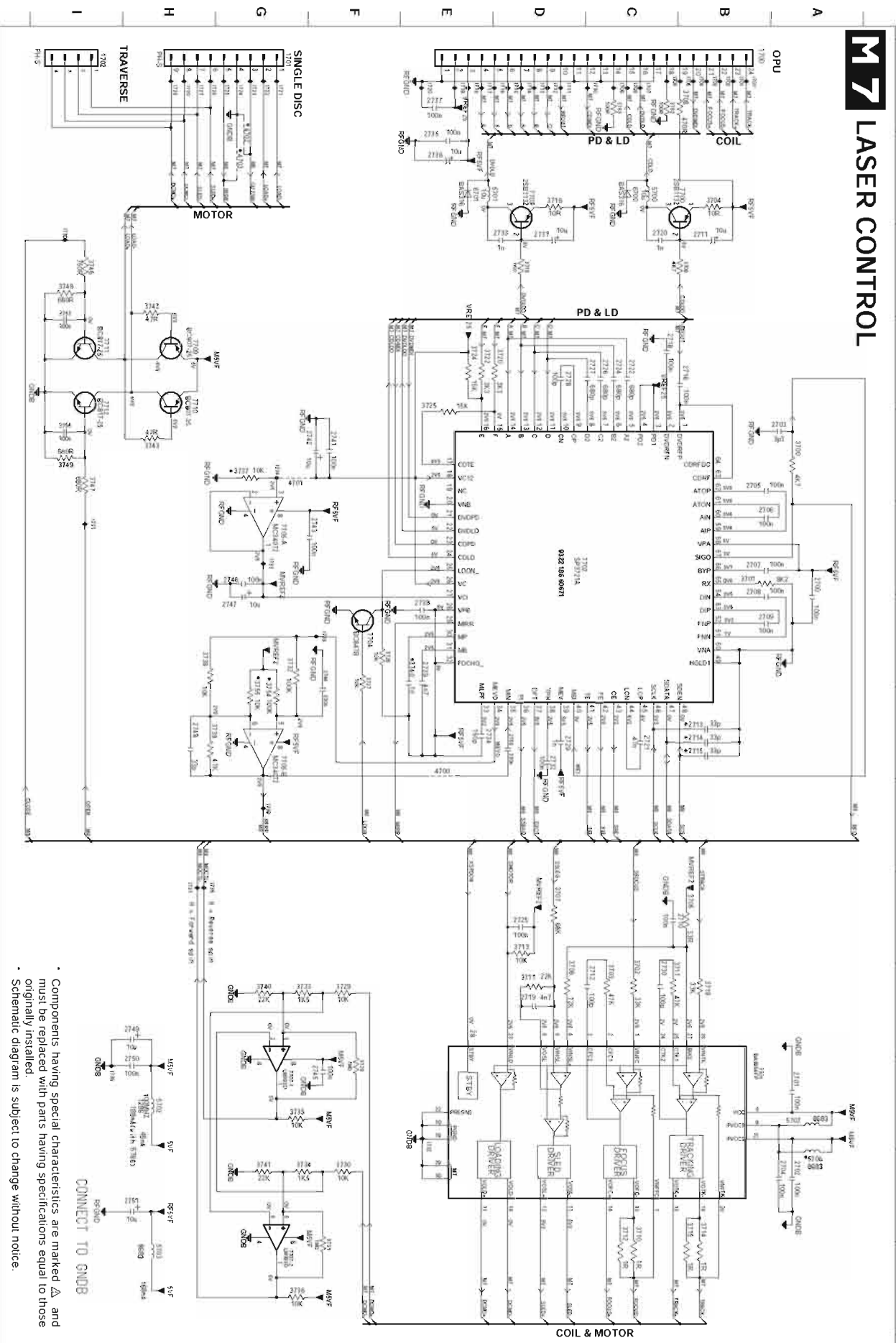

The first digit of a component indicates the component type.
 1xxx : Connector 3xxx : Resistor 5xxx : Coil 7xxx : IC, Transistor, FET
 2xxx : Capacitor 4xxx : SMD Jumper 6xxx : Diode 9xxx : Wire Jumper

Components having special characteristics are marked Δ and must be replaced with parts having specifications equal to those originally installed.
 Schematic diagram is subject to change without notice.

1900 G1	5201 A12
1901 G1	5202 E2
1902 G1	5203 E2
1903 G1	5204 E2
1904 G1	5205 E2
1905 G1	5206 E2
1906 G1	5207 E2
1907 G1	5208 E2
1908 G1	5209 E2
1909 G1	5210 E2
1910 G1	5211 E2
1911 G1	5212 E2
1912 G1	5213 E2
1913 G1	5214 E2
1914 G1	5215 E2
1915 G1	5216 E2
1916 G1	5217 E2
1917 G1	5218 E2
1918 G1	5219 E2
1919 G1	5220 E2
1920 G1	5221 E2
1921 G1	5222 E2
1922 G1	5223 E2
1923 G1	5224 E2
1924 G1	5225 E2
1925 G1	5226 E2
1926 G1	5227 E2
1927 G1	5228 E2
1928 G1	5229 E2
1929 G1	5230 E2
1930 G1	5231 E2
1931 G1	5232 E2
1932 G1	5233 E2
1933 G1	5234 E2
1934 G1	5235 E2
1935 G1	5236 E2
1936 G1	5237 E2
1937 G1	5238 E2
1938 G1	5239 E2
1939 G1	5240 E2
1940 G1	5241 E2
1941 G1	5242 E2
1942 G1	5243 E2
1943 G1	5244 E2
1944 G1	5245 E2
1945 G1	5246 E2
1946 G1	5247 E2
1947 G1	5248 E2
1948 G1	5249 E2
1949 G1	5250 E2
1950 G1	5251 E2
1951 G1	5252 E2
1952 G1	5253 E2
1953 G1	5254 E2
1954 G1	5255 E2
1955 G1	5256 E2
1956 G1	5257 E2
1957 G1	5258 E2
1958 G1	5259 E2
1959 G1	5260 E2
1960 G1	5261 E2
1961 G1	5262 E2
1962 G1	5263 E2
1963 G1	5264 E2
1964 G1	5265 E2
1965 G1	5266 E2
1966 G1	5267 E2
1967 G1	5268 E2
1968 G1	5269 E2
1969 G1	5270 E2
1970 G1	5271 E2
1971 G1	5272 E2
1972 G1	5273 E2
1973 G1	5274 E2
1974 G1	5275 E2
1975 G1	5276 E2
1976 G1	5277 E2
1977 G1	5278 E2
1978 G1	5279 E2
1979 G1	5280 E2
1980 G1	5281 E2
1981 G1	5282 E2
1982 G1	5283 E2
1983 G1	5284 E2
1984 G1	5285 E2
1985 G1	5286 E2
1986 G1	5287 E2
1987 G1	5288 E2
1988 G1	5289 E2
1989 G1	5290 E2
1990 G1	5291 E2
1991 G1	5292 E2
1992 G1	5293 E2
1993 G1	5294 E2
1994 G1	5295 E2
1995 G1	5296 E2
1996 G1	5297 E2
1997 G1	5298 E2
1998 G1	5299 E2
1999 G1	5300 E2

DVR-S200 SCHEMATIC DIAGRAM (MONO 8/9) FOR INFORMATION ONLY (NO SERVICE PARTS WILL BE AVAILABLE)

M8 FRONT END CONTROLLER

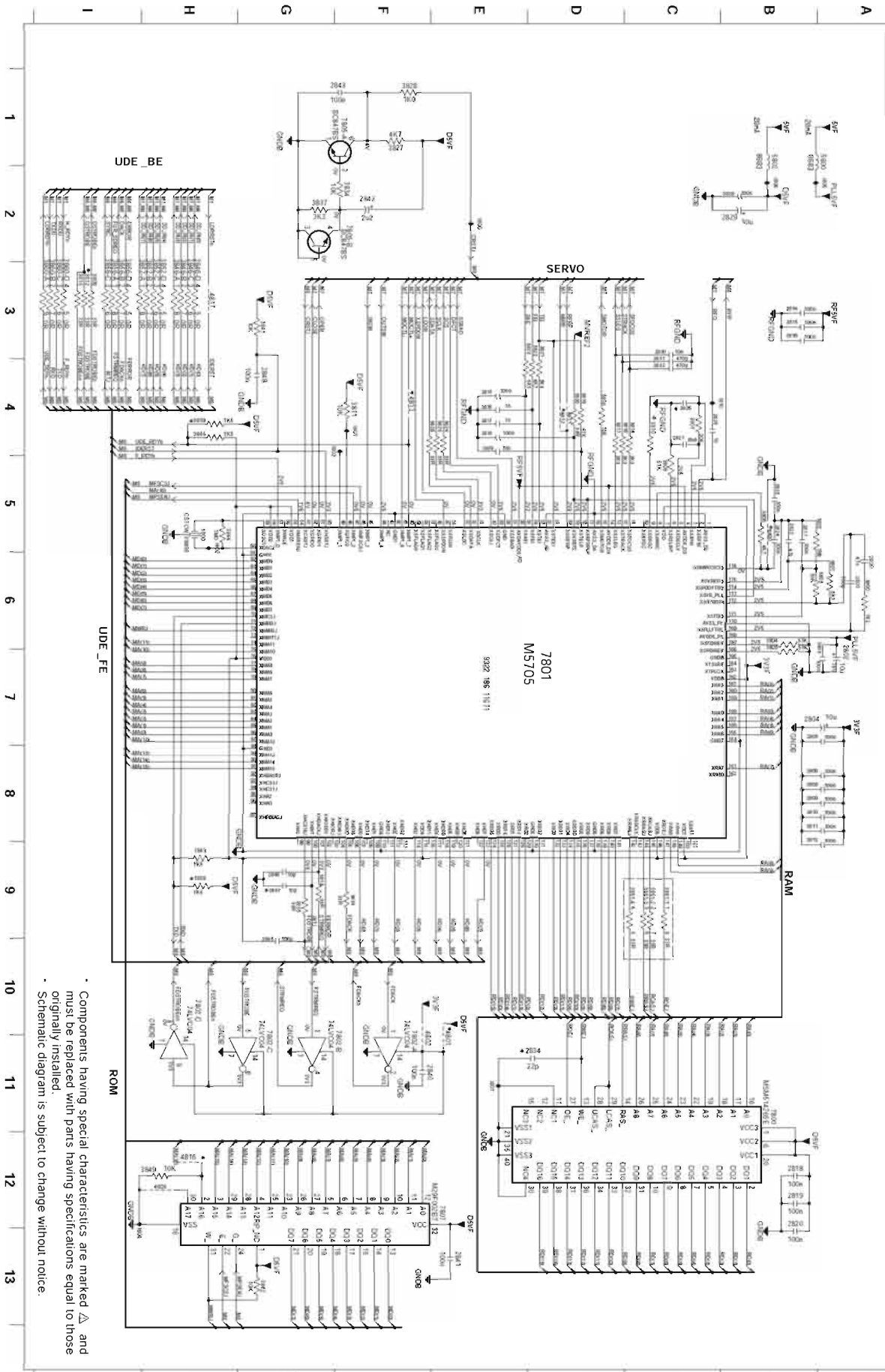

The first digit of a component indicates the component type.
 1xxx : Connector 3xxx : Resistor 5xxx : Coil
 2xxx : Capacitor 4xxx : SMD jumper 6xxx : Diode 9xxx : Wire jumper

- Components having special characteristics are marked Δ and must be replaced with parts having specifications equal to those originally installed.
- Schematic diagram is subject to change without notice.

1269 IC	481 F4
1291 AS	497 F4
1307 AV	500 F4
1318 BK	512 F4
1344 BK	520 F4
1352 BK	530 F4
1355 BK	540 F4
1359 BK	550 F4
1361 BK	560 F4
1363 BK	570 F4
1365 BK	580 F4
1367 BK	590 F4
1369 BK	600 F4
1371 BK	610 F4
1373 BK	620 F4
1375 BK	630 F4
1377 BK	640 F4
1379 BK	650 F4
1381 BK	660 F4
1383 BK	670 F4
1385 BK	680 F4
1387 BK	690 F4
1389 BK	700 F4
1391 BK	710 F4
1393 BK	720 F4
1395 BK	730 F4
1397 BK	740 F4
1399 BK	750 F4
1401 BK	760 F4
1403 BK	770 F4
1405 BK	780 F4
1407 BK	790 F4
1409 BK	800 F4
1411 BK	810 F4
1413 BK	820 F4
1415 BK	830 F4
1417 BK	840 F4
1419 BK	850 F4
1421 BK	860 F4
1423 BK	870 F4
1425 BK	880 F4
1427 BK	890 F4
1429 BK	900 F4
1431 BK	910 F4
1433 BK	920 F4
1435 BK	930 F4
1437 BK	940 F4
1439 BK	950 F4
1441 BK	960 F4
1443 BK	970 F4
1445 BK	980 F4
1447 BK	990 F4
1449 BK	1000 F4

■ DVR-S200 SCHEMATIC DIAGRAM (MONO 9/9)
 FOR INFORMATION ONLY (NO SERVICE PARTS WILL BE AVAILABLE)

The first digit of a component indicates the component type.
 1xxx : Connector 3xxx : Resistor 7xxx : IC, Transistor, FET
 2xxx : Capacitor 4xxx : SMD Jumper 6xxx : Diode 9xxx : Wire Jumper

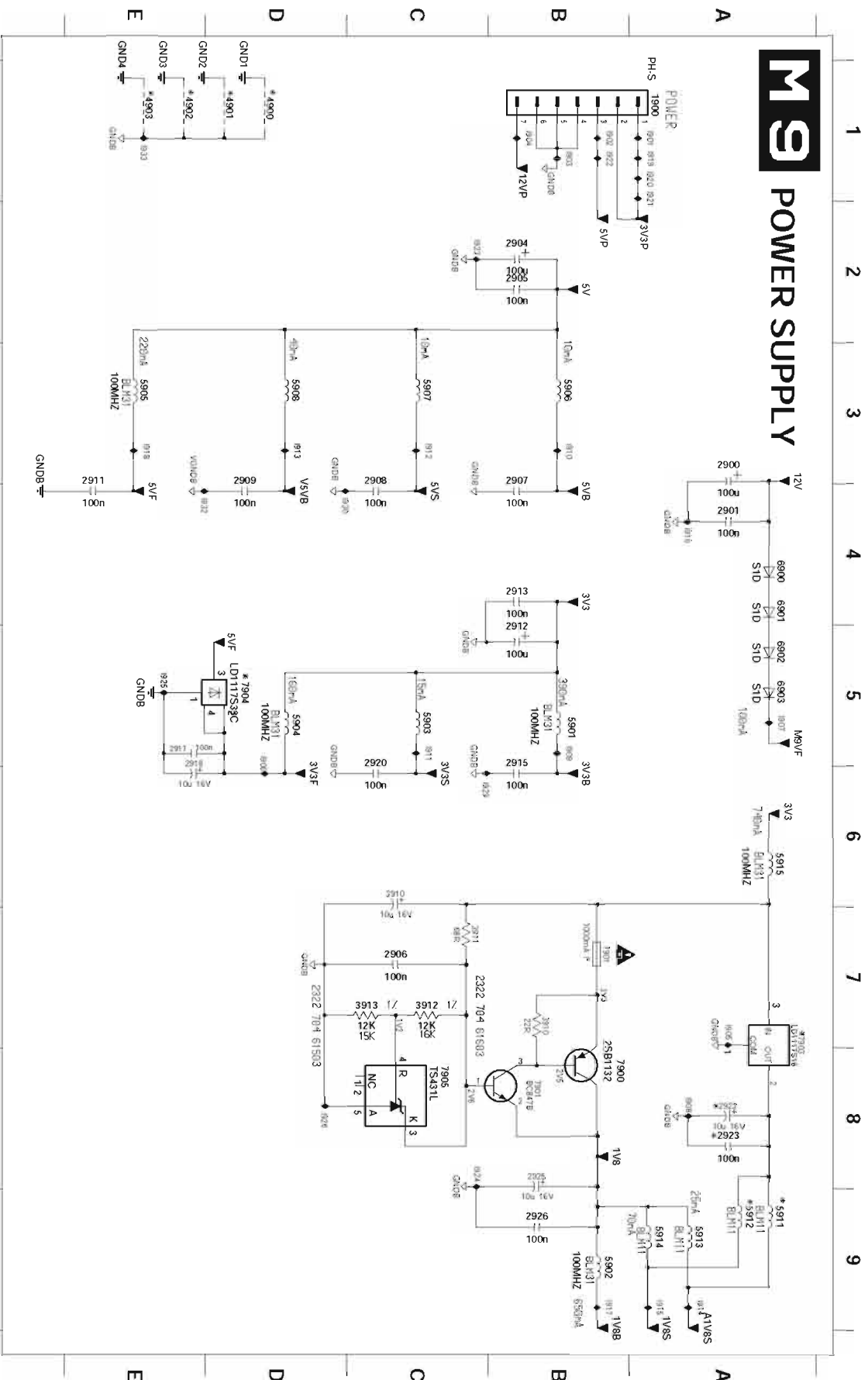

1900 A1	1920 A1
1901 B7	1921 A1
1900 A3	1922 B1
2901 A4	1923 C2
2904 B2	1924 C8
2905 B2	1925 E5
2906 C7	1926 D8
2907 B3	1928 C6
2908 C3	1930 D4
2909 D3	1932 E4
2910 C6	1933 E1
2911 E3	
2912 B5	
2913 B4	
2915 B5	
2917 E5	
2918 E6	
2920 C6	
2922 A6	
2924 A6	
2925 B6	
2926 B6	
2928 B9	
2930 B7	
2931 C7	
2932 C7	
2933 C7	
4900 D1	
4901 D1	
4902 E1	
4903 E1	
5901 B5	
5902 B9	
5903 C5	
5904 D5	
5905 E3	
5906 B3	
5907 C3	
5908 D3	
5911 A9	
5912 A9	
5913 A9	
5914 A9	
5915 A6	
6900 A4	
6901 A4	
6902 A5	
6903 A5	
7900 B8	
7901 B8	
7903 A7	
7904 D5	
7905 C8	
1901 A1	
1902 B1	
1903 B1	
1904 B1	
1905 A7	
1906 D5	
1907 A5	
1908 A8	
1909 B5	
1910 B3	
1911 C5	
1912 C3	
1913 D3	
1914 A9	
1915 A9	
1916 A4	
1917 B9	
1918 E3	
1919 A1	

Components having special characteristics are marked Δ and must be replaced with parts having specifications equal to those originally installed.
 Schematic diagram is subject to change without notice.

DVR-S-200 SCHEMATIC DIAGRAM (DIGITAL)

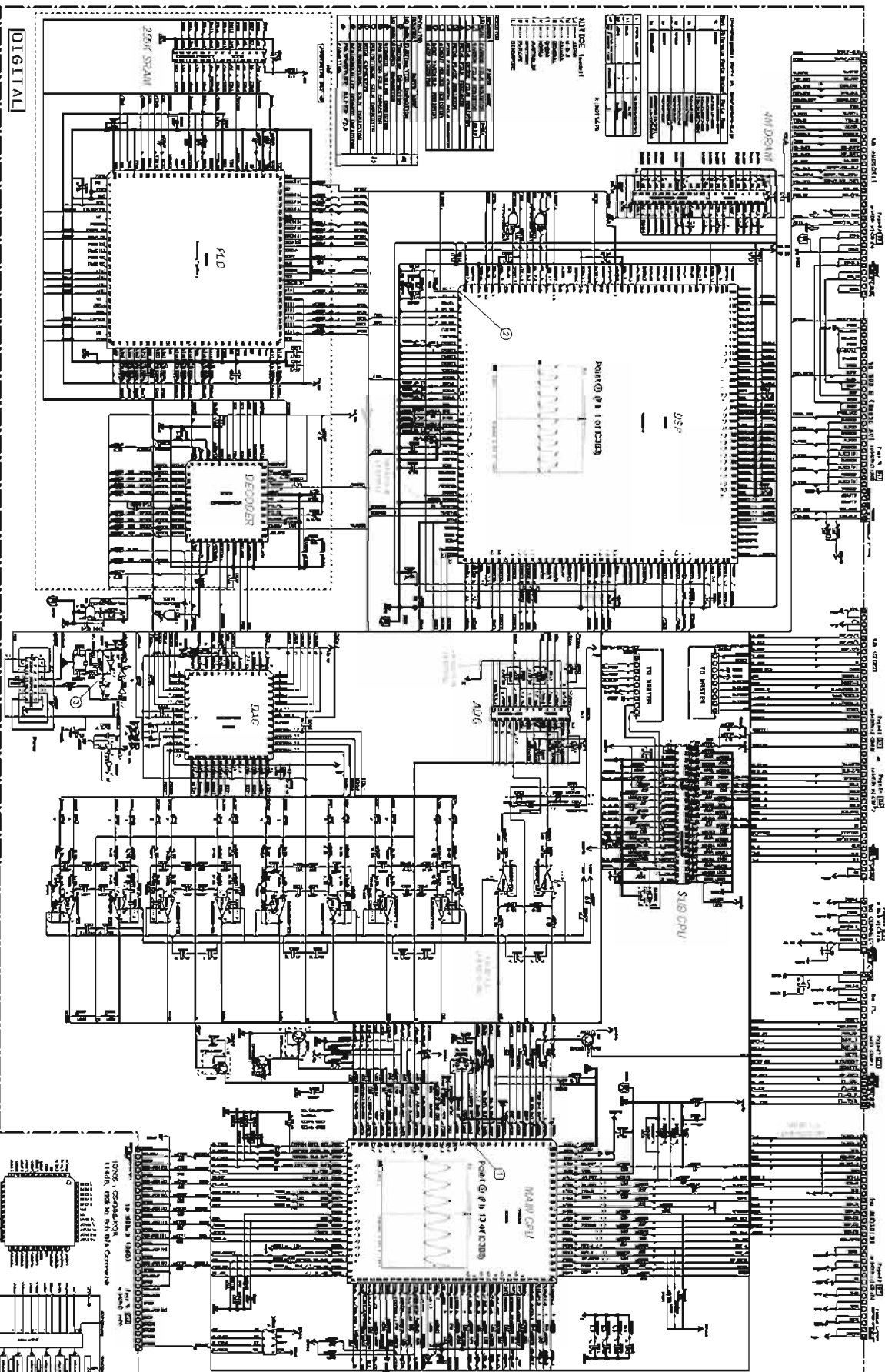

IC001 CONVERSION (DIGITAL) SIGNAL INPUT

IC004 SIGNAL PROCESSOR

IC002 ANALOG TO DIGITAL CONVERTER

IC003 CPU

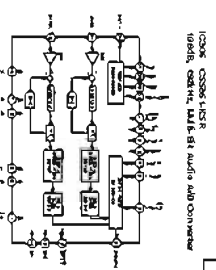
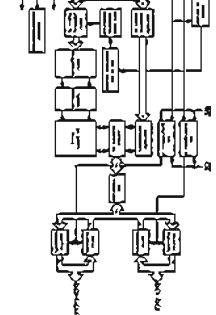
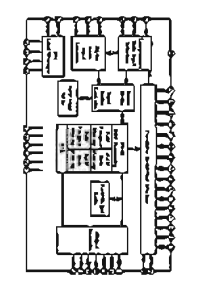
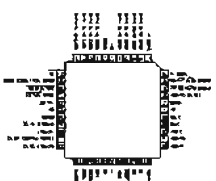
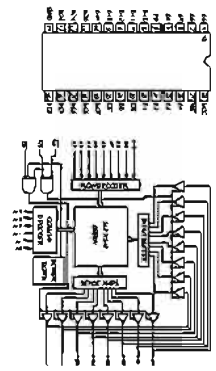

All resistors are measured with a 100kV DC Ohmmeter and will be replaced with parts having impedance equal to their original value.

Schematic diagram is subject to change without notice.

DVR-S200 SCHEMATIC DIAGRAM (MAIN 1/4)

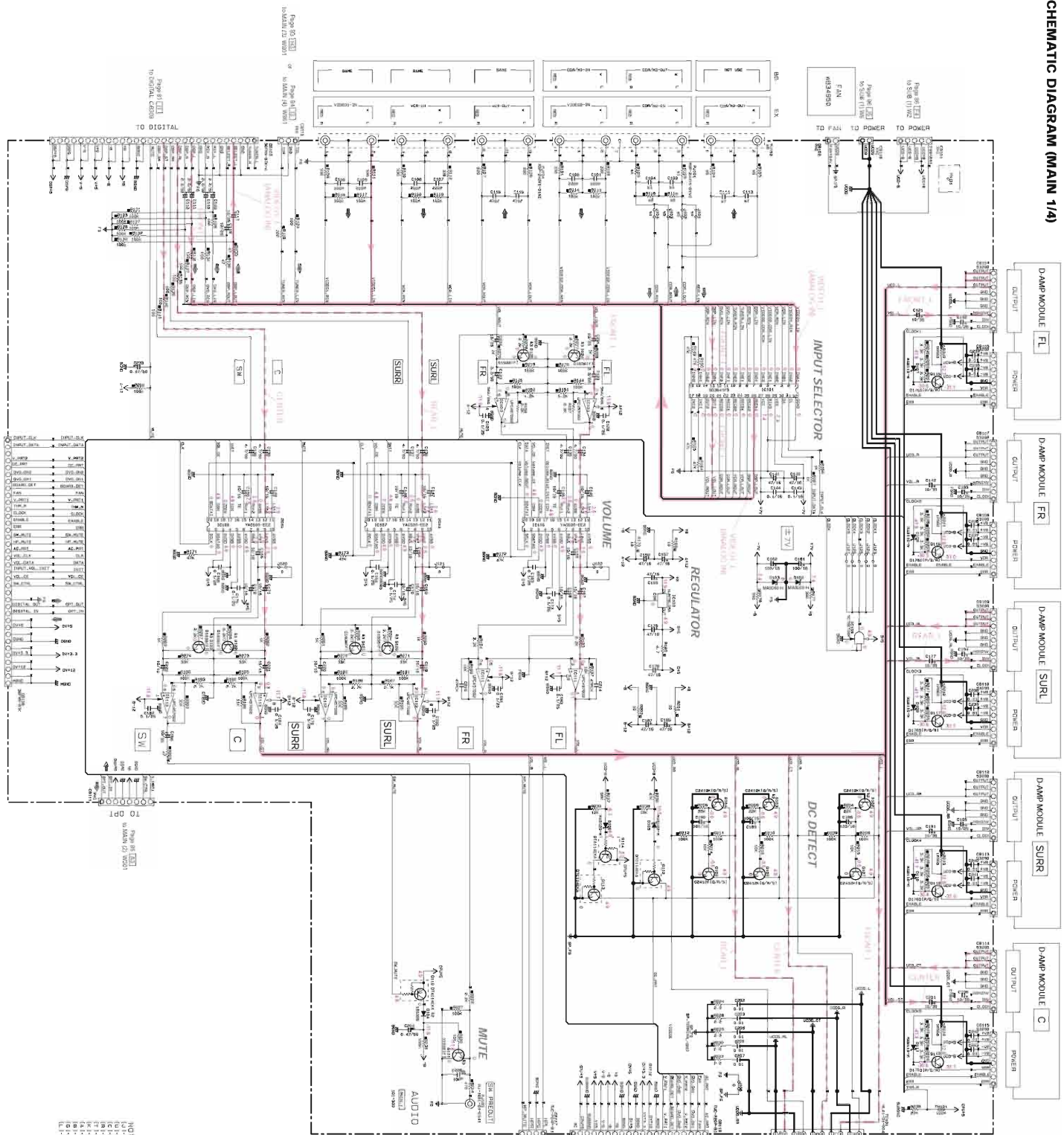

- D-AMP MODULE FL
- D-AMP MODULE FR
- D-AMP MODULE SURR
- D-AMP MODULE SURR
- D-AMP MODULE C

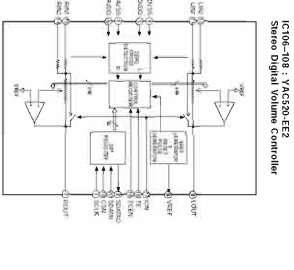
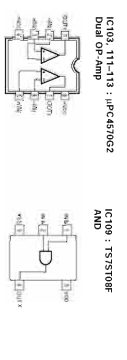
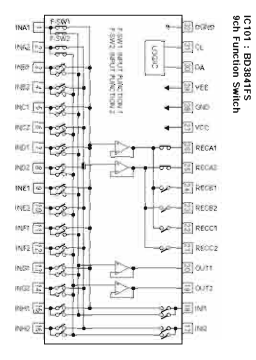

RESISTORS

NO.	VALUE	TYPE	WATTAGE	REMARKS
1	10K	RES	1/4W	RESISTOR
2	10K	RES	1/4W	RESISTOR
3	10K	RES	1/4W	RESISTOR
4	10K	RES	1/4W	RESISTOR
5	10K	RES	1/4W	RESISTOR
6	10K	RES	1/4W	RESISTOR
7	10K	RES	1/4W	RESISTOR
8	10K	RES	1/4W	RESISTOR
9	10K	RES	1/4W	RESISTOR
10	10K	RES	1/4W	RESISTOR
11	10K	RES	1/4W	RESISTOR
12	10K	RES	1/4W	RESISTOR
13	10K	RES	1/4W	RESISTOR
14	10K	RES	1/4W	RESISTOR
15	10K	RES	1/4W	RESISTOR
16	10K	RES	1/4W	RESISTOR
17	10K	RES	1/4W	RESISTOR
18	10K	RES	1/4W	RESISTOR
19	10K	RES	1/4W	RESISTOR
20	10K	RES	1/4W	RESISTOR

NOTICE (Import)

NO.	DESCRIPTION	REMARKS
1	RESISTOR	RESISTOR
2	CAPACITOR	CAPACITOR
3	IC	IC
4	DIODE	DIODE
5	TRANSISTOR	TRANSISTOR
6	RELAY	RELAY
7	CONNECTOR	CONNECTOR
8	SWITCH	SWITCH
9	INDUCTOR	INDUCTOR
10	OTHER	OTHER
11
12
13
14
15
16
17
18
19
20

All voltages are measured with a 10MΩVDC electronic voltmeter. Components having special characteristics are marked with a triangle and must be replaced with parts having specifications equal to those originally installed. Schematic diagram is subject to change without notice.

■ DVR-S200 SCHEMATIC DIAGRAM (MAIN 2/4)

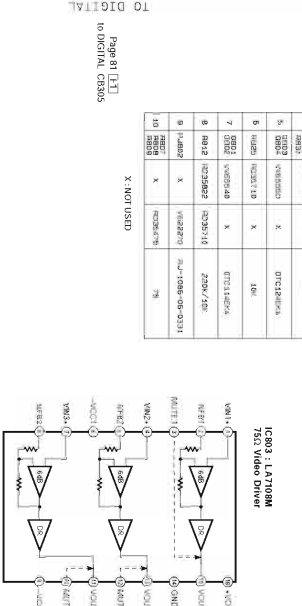
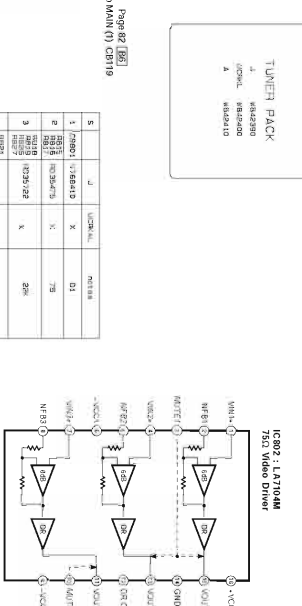
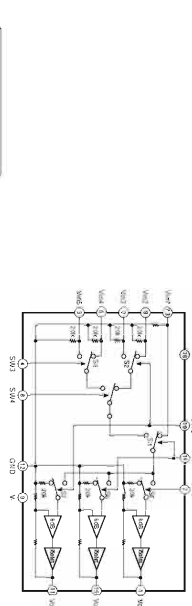
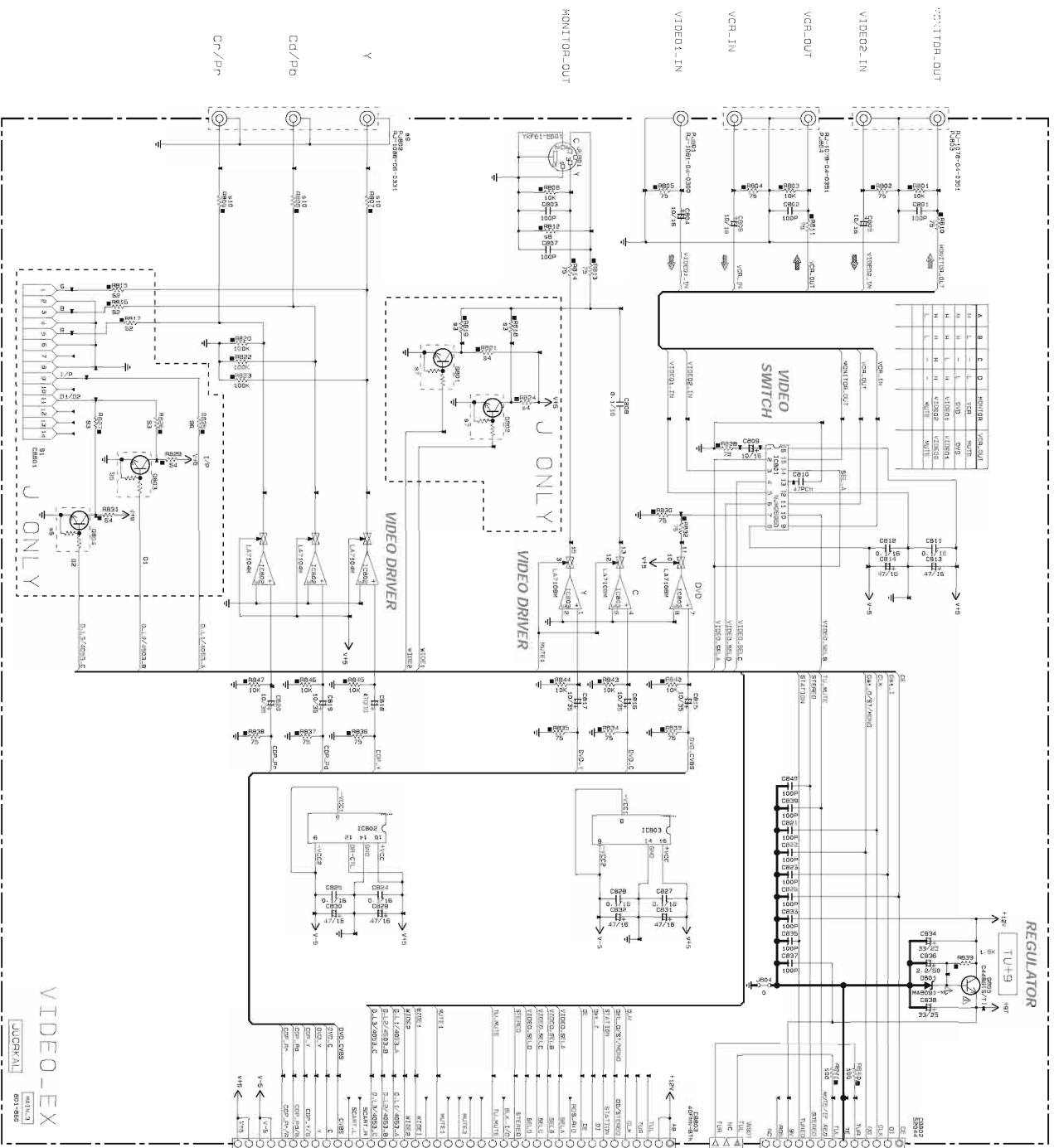

Page 87 [86]
IC MAIN (1) CRT19

5	J	IC801	M48250
1	IC802	LATA08M	D1
2	IC803	LATA08M	X
3	IC804	LATA08M	X
4	IC805	LATA08M	X
5	IC806	LATA08M	X
6	IC807	LATA08M	X
7	IC808	LATA08M	X
8	IC809	LATA08M	X
9	IC810	LATA08M	X
10	IC811	LATA08M	X

Page 88 [87]
IC DIGITAL
IC805

NOTICE (model):

RESISTOR

①	RESISTOR	DATA'S VALUE
②	RESISTOR	DATA'S VALUE
③	RESISTOR	DATA'S VALUE
④	RESISTOR	DATA'S VALUE
⑤	RESISTOR	DATA'S VALUE
⑥	RESISTOR	DATA'S VALUE
⑦	RESISTOR	DATA'S VALUE
⑧	RESISTOR	DATA'S VALUE
⑨	RESISTOR	DATA'S VALUE
⑩	RESISTOR	DATA'S VALUE
⑪	RESISTOR	DATA'S VALUE
⑫	RESISTOR	DATA'S VALUE
⑬	RESISTOR	DATA'S VALUE
⑭	RESISTOR	DATA'S VALUE
⑮	RESISTOR	DATA'S VALUE
⑯	RESISTOR	DATA'S VALUE
⑰	RESISTOR	DATA'S VALUE
⑱	RESISTOR	DATA'S VALUE
⑲	RESISTOR	DATA'S VALUE
⑳	RESISTOR	DATA'S VALUE
㉑	RESISTOR	DATA'S VALUE
㉒	RESISTOR	DATA'S VALUE
㉓	RESISTOR	DATA'S VALUE
㉔	RESISTOR	DATA'S VALUE
㉕	RESISTOR	DATA'S VALUE
㉖	RESISTOR	DATA'S VALUE
㉗	RESISTOR	DATA'S VALUE
㉘	RESISTOR	DATA'S VALUE
㉙	RESISTOR	DATA'S VALUE
㉚	RESISTOR	DATA'S VALUE
㉛	RESISTOR	DATA'S VALUE
㉜	RESISTOR	DATA'S VALUE
㉝	RESISTOR	DATA'S VALUE
㉞	RESISTOR	DATA'S VALUE
㉟	RESISTOR	DATA'S VALUE
㊱	RESISTOR	DATA'S VALUE
㊲	RESISTOR	DATA'S VALUE
㊳	RESISTOR	DATA'S VALUE
㊴	RESISTOR	DATA'S VALUE
㊵	RESISTOR	DATA'S VALUE
㊶	RESISTOR	DATA'S VALUE
㊷	RESISTOR	DATA'S VALUE
㊸	RESISTOR	DATA'S VALUE
㊹	RESISTOR	DATA'S VALUE
㊺	RESISTOR	DATA'S VALUE
㊻	RESISTOR	DATA'S VALUE
㊼	RESISTOR	DATA'S VALUE
㊽	RESISTOR	DATA'S VALUE
㊾	RESISTOR	DATA'S VALUE
㊿	RESISTOR	DATA'S VALUE

* All voltages are measured with a 10MΩV DC electronic voltmeter.
* Components having special characteristics are marked Δ and must be replaced with parts having specifications equal to those originally installed.
* Schematic diagram is subject to change without notice.

■ DVR-S200 SCHEMATIC DIAGRAM (MAIN 3/4)

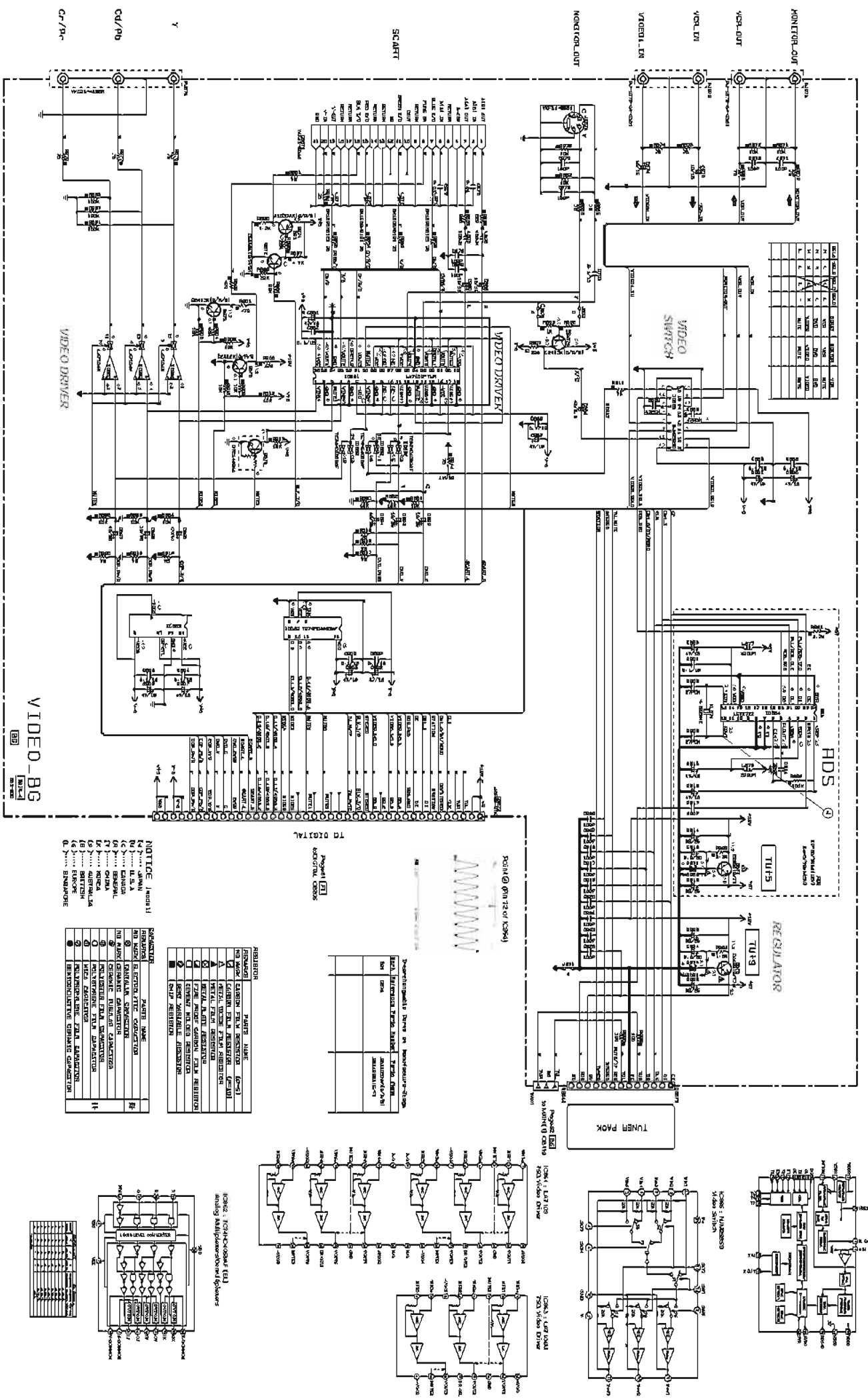

IC	SYMBOL	FUNCTION	MARKING	REF.
1	IC1	VIDEO SWITCH	IC1	1
2	IC2	VIDEO DRIVER	IC2	2
3	IC3	VIDEO DRIVER	IC3	3
4	IC4	VIDEO DRIVER	IC4	4
5	IC5	VIDEO DRIVER	IC5	5
6	IC6	VIDEO DRIVER	IC6	6
7	IC7	VIDEO DRIVER	IC7	7
8	IC8	VIDEO DRIVER	IC8	8
9	IC9	VIDEO DRIVER	IC9	9
10	IC10	VIDEO DRIVER	IC10	10
11	IC11	VIDEO DRIVER	IC11	11
12	IC12	VIDEO DRIVER	IC12	12
13	IC13	VIDEO DRIVER	IC13	13
14	IC14	VIDEO DRIVER	IC14	14
15	IC15	VIDEO DRIVER	IC15	15
16	IC16	VIDEO DRIVER	IC16	16
17	IC17	VIDEO DRIVER	IC17	17
18	IC18	VIDEO DRIVER	IC18	18
19	IC19	VIDEO DRIVER	IC19	19
20	IC20	VIDEO DRIVER	IC20	20
21	IC21	VIDEO DRIVER	IC21	21
22	IC22	VIDEO DRIVER	IC22	22
23	IC23	VIDEO DRIVER	IC23	23
24	IC24	VIDEO DRIVER	IC24	24
25	IC25	VIDEO DRIVER	IC25	25
26	IC26	VIDEO DRIVER	IC26	26
27	IC27	VIDEO DRIVER	IC27	27
28	IC28	VIDEO DRIVER	IC28	28
29	IC29	VIDEO DRIVER	IC29	29
30	IC30	VIDEO DRIVER	IC30	30
31	IC31	VIDEO DRIVER	IC31	31
32	IC32	VIDEO DRIVER	IC32	32
33	IC33	VIDEO DRIVER	IC33	33
34	IC34	VIDEO DRIVER	IC34	34
35	IC35	VIDEO DRIVER	IC35	35
36	IC36	VIDEO DRIVER	IC36	36
37	IC37	VIDEO DRIVER	IC37	37
38	IC38	VIDEO DRIVER	IC38	38
39	IC39	VIDEO DRIVER	IC39	39
40	IC40	VIDEO DRIVER	IC40	40
41	IC41	VIDEO DRIVER	IC41	41
42	IC42	VIDEO DRIVER	IC42	42
43	IC43	VIDEO DRIVER	IC43	43
44	IC44	VIDEO DRIVER	IC44	44
45	IC45	VIDEO DRIVER	IC45	45
46	IC46	VIDEO DRIVER	IC46	46
47	IC47	VIDEO DRIVER	IC47	47
48	IC48	VIDEO DRIVER	IC48	48
49	IC49	VIDEO DRIVER	IC49	49
50	IC50	VIDEO DRIVER	IC50	50
51	IC51	VIDEO DRIVER	IC51	51
52	IC52	VIDEO DRIVER	IC52	52
53	IC53	VIDEO DRIVER	IC53	53
54	IC54	VIDEO DRIVER	IC54	54
55	IC55	VIDEO DRIVER	IC55	55
56	IC56	VIDEO DRIVER	IC56	56
57	IC57	VIDEO DRIVER	IC57	57
58	IC58	VIDEO DRIVER	IC58	58
59	IC59	VIDEO DRIVER	IC59	59
60	IC60	VIDEO DRIVER	IC60	60
61	IC61	VIDEO DRIVER	IC61	61
62	IC62	VIDEO DRIVER	IC62	62
63	IC63	VIDEO DRIVER	IC63	63
64	IC64	VIDEO DRIVER	IC64	64
65	IC65	VIDEO DRIVER	IC65	65
66	IC66	VIDEO DRIVER	IC66	66
67	IC67	VIDEO DRIVER	IC67	67
68	IC68	VIDEO DRIVER	IC68	68
69	IC69	VIDEO DRIVER	IC69	69
70	IC70	VIDEO DRIVER	IC70	70
71	IC71	VIDEO DRIVER	IC71	71
72	IC72	VIDEO DRIVER	IC72	72
73	IC73	VIDEO DRIVER	IC73	73
74	IC74	VIDEO DRIVER	IC74	74
75	IC75	VIDEO DRIVER	IC75	75
76	IC76	VIDEO DRIVER	IC76	76
77	IC77	VIDEO DRIVER	IC77	77
78	IC78	VIDEO DRIVER	IC78	78
79	IC79	VIDEO DRIVER	IC79	79
80	IC80	VIDEO DRIVER	IC80	80
81	IC81	VIDEO DRIVER	IC81	81
82	IC82	VIDEO DRIVER	IC82	82
83	IC83	VIDEO DRIVER	IC83	83
84	IC84	VIDEO DRIVER	IC84	84
85	IC85	VIDEO DRIVER	IC85	85
86	IC86	VIDEO DRIVER	IC86	86
87	IC87	VIDEO DRIVER	IC87	87
88	IC88	VIDEO DRIVER	IC88	88
89	IC89	VIDEO DRIVER	IC89	89
90	IC90	VIDEO DRIVER	IC90	90
91	IC91	VIDEO DRIVER	IC91	91
92	IC92	VIDEO DRIVER	IC92	92
93	IC93	VIDEO DRIVER	IC93	93
94	IC94	VIDEO DRIVER	IC94	94
95	IC95	VIDEO DRIVER	IC95	95
96	IC96	VIDEO DRIVER	IC96	96
97	IC97	VIDEO DRIVER	IC97	97
98	IC98	VIDEO DRIVER	IC98	98
99	IC99	VIDEO DRIVER	IC99	99
100	IC100	VIDEO DRIVER	IC100	100

NOTICE (PARTS)
 1. All components are required with a 270kΩV DC electronic part number.
 2. Components having special characteristics are marked with a triangle and must be replaced with parts having specifications equal to those originally installed.
 3. Schematic diagrams are subject to change without notice.

RESISTOR	PART NAME	MARKING
100Ω	RESISTOR	100
10kΩ	RESISTOR	10K
100kΩ	RESISTOR	100K
1MΩ	RESISTOR	1M
10MΩ	RESISTOR	10M
100MΩ	RESISTOR	100M
1GΩ	RESISTOR	1G
10GΩ	RESISTOR	10G
100GΩ	RESISTOR	100G
1TΩ	RESISTOR	1T
10TΩ	RESISTOR	10T
100TΩ	RESISTOR	100T
1PTΩ	RESISTOR	1PT
10PTΩ	RESISTOR	10PT
100PTΩ	RESISTOR	100PT
1MΩ	RESISTOR	1M
10MΩ	RESISTOR	10M
100MΩ	RESISTOR	100M
1GΩ	RESISTOR	1G
10GΩ	RESISTOR	10G
100GΩ	RESISTOR	100G
1TΩ	RESISTOR	1T
10TΩ	RESISTOR	10T
100TΩ	RESISTOR	100T

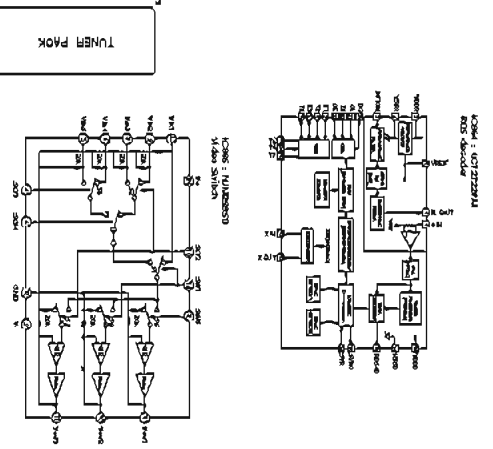
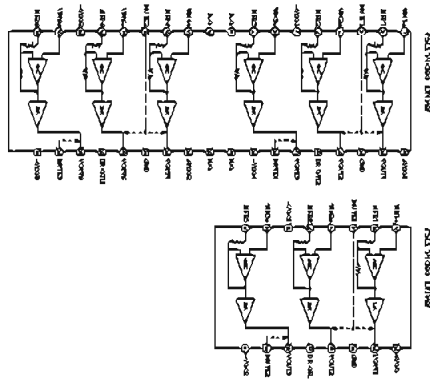
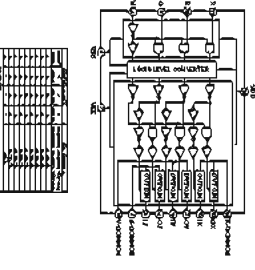

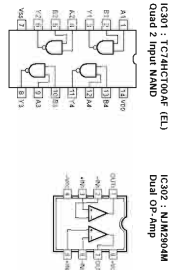
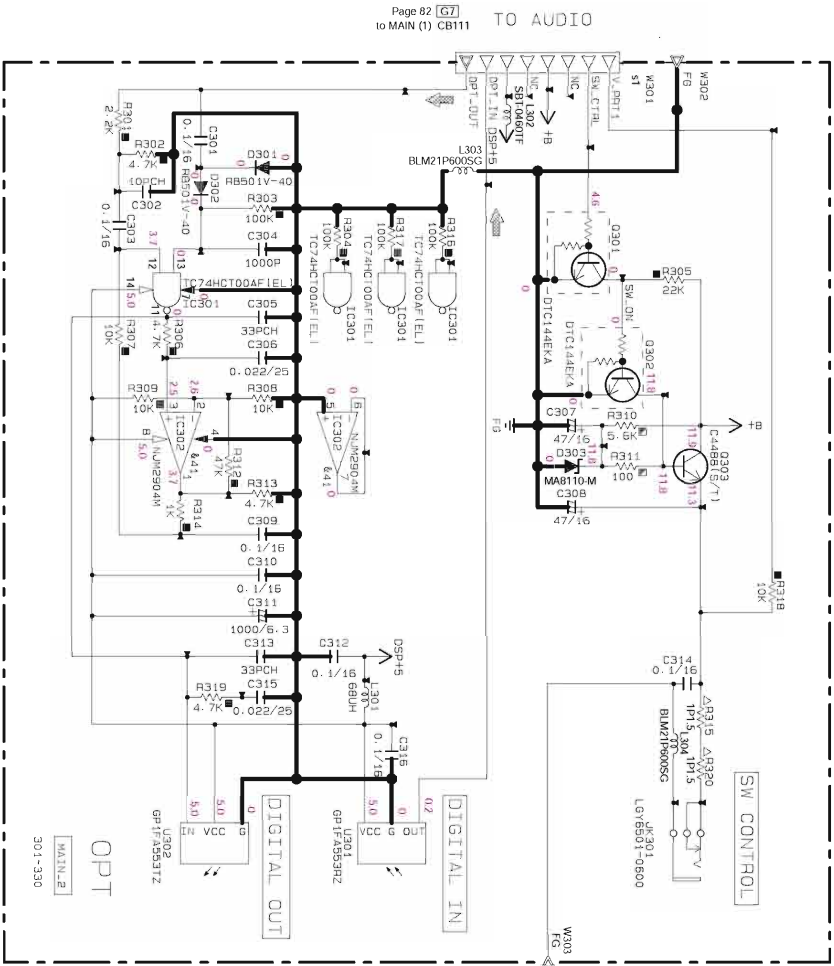

Interchangeable Parts at Manufacture-Stage

Mark	Reference Parts Number	Part's Name
441	IC302	NJM2904M NJM2904G

Reference No	J	U.C.R.K.A.B.G.L
S1	W301	M810907 M810818

NOTICE (model)

(J)..... JAPAN
 (U)..... U.S.A
 (C)..... CANADA
 (R)..... GENERAL
 (T)..... CHINA
 (K)..... KOREA
 (A)..... AUSTRALIA
 (B)..... BRITISH
 (S)..... EUROPE
 (L)..... SINGAPORE

RESISTOR

REMARKS	PARTS NAME
NO MARK	CARBON FILM RESISTOR (P=5)
□	CARBON FILM RESISTOR (P=10)
△	METAL OXIDE FILM RESISTOR
▲	METAL FILM RESISTOR
⊠	METAL PLATE RESISTOR
▨	FIRE PROOF CARBON FILM RESISTOR
□	CEMENT MOLDED RESISTOR
◇	SEMI VARIABLE RESISTOR
■	CHIP RESISTOR

CAPACITOR

REMARKS	PARTS NAME
NO MARK	ELECTROLYTIC CAPACITOR
⊗	TANTALUM CAPACITOR
◎	CERAMIC CAPACITOR
⊙	CERAMIC TUBULAR CAPACITOR
○	POLYESTER FILM CAPACITOR
⊖	POLYSTYRENE FILM CAPACITOR
⊕	MICA CAPACITOR
⊗	POLYPROPYLENE FILM CAPACITOR
⊙	SEMI CONDUCTIVE CERAMIC CAPACITOR

* All voltages are measured with a 10MHz DC electronic voltmeter.
 * Components having special characteristics are marked Δ and must be replaced with parts having specifications equal to those originally installed.
 * Schematic diagram is subject to change without notice.

DVR-S200 SCHEMATIC DIAGRAM (SUB)

№	MARKING	SYMBOL	NAME	VALUE	UNIT	REMARKS
1	100K	RES	RESISTOR	100K	Ω	
2	10K	RES	RESISTOR	10K	Ω	
3	100Ω	RES	RESISTOR	100Ω	Ω	
4	100nF	CAP	CAPACITOR	100nF	nF	
5	10μF	CAP	CAPACITOR	10μF	μF	
6	100μF	CAP	CAPACITOR	100μF	μF	
7	1000μF	CAP	CAPACITOR	1000μF	μF	
8	10000μF	CAP	CAPACITOR	10000μF	μF	
9	100000μF	CAP	CAPACITOR	100000μF	μF	
10	1000000μF	CAP	CAPACITOR	1000000μF	μF	

X NOT USED

№	MARKING	SYMBOL	NAME	VALUE	UNIT	REMARKS
1	100K	RES	RESISTOR	100K	Ω	
2	10K	RES	RESISTOR	10K	Ω	
3	100Ω	RES	RESISTOR	100Ω	Ω	
4	100nF	CAP	CAPACITOR	100nF	nF	
5	10μF	CAP	CAPACITOR	10μF	μF	
6	100μF	CAP	CAPACITOR	100μF	μF	
7	1000μF	CAP	CAPACITOR	1000μF	μF	
8	10000μF	CAP	CAPACITOR	10000μF	μF	
9	100000μF	CAP	CAPACITOR	100000μF	μF	
10	1000000μF	CAP	CAPACITOR	1000000μF	μF	

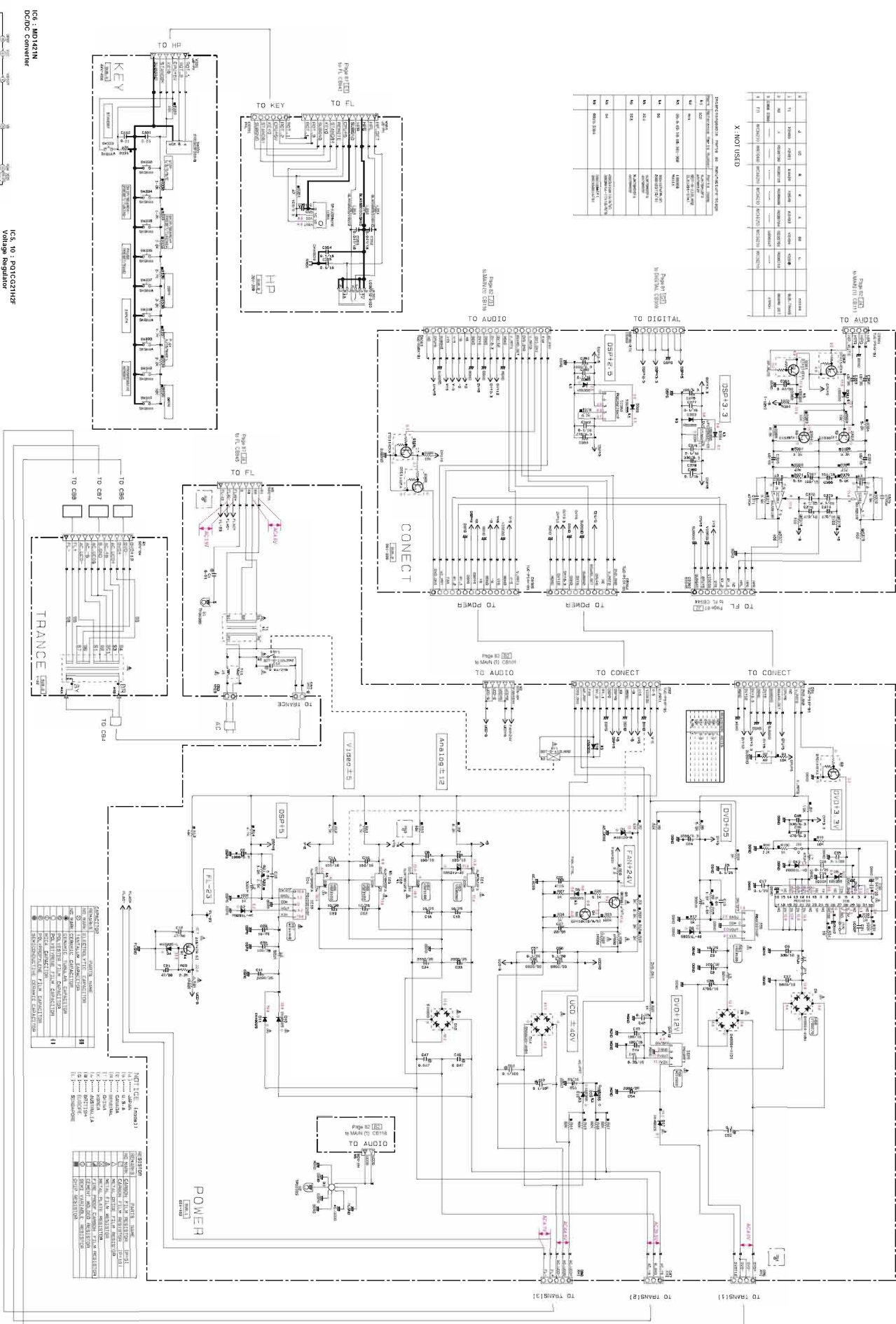

№	MARKING	SYMBOL	NAME	VALUE	UNIT	REMARKS
1	100K	RES	RESISTOR	100K	Ω	
2	10K	RES	RESISTOR	10K	Ω	
3	100Ω	RES	RESISTOR	100Ω	Ω	
4	100nF	CAP	CAPACITOR	100nF	nF	
5	10μF	CAP	CAPACITOR	10μF	μF	
6	100μF	CAP	CAPACITOR	100μF	μF	
7	1000μF	CAP	CAPACITOR	1000μF	μF	
8	10000μF	CAP	CAPACITOR	10000μF	μF	
9	100000μF	CAP	CAPACITOR	100000μF	μF	
10	1000000μF	CAP	CAPACITOR	1000000μF	μF	

№	MARKING	SYMBOL	NAME	VALUE	UNIT	REMARKS
1	100K	RES	RESISTOR	100K	Ω	
2	10K	RES	RESISTOR	10K	Ω	
3	100Ω	RES	RESISTOR	100Ω	Ω	
4	100nF	CAP	CAPACITOR	100nF	nF	
5	10μF	CAP	CAPACITOR	10μF	μF	
6	100μF	CAP	CAPACITOR	100μF	μF	
7	1000μF	CAP	CAPACITOR	1000μF	μF	
8	10000μF	CAP	CAPACITOR	10000μF	μF	
9	100000μF	CAP	CAPACITOR	100000μF	μF	
10	1000000μF	CAP	CAPACITOR	1000000μF	μF	

№	MARKING	SYMBOL	NAME	VALUE	UNIT	REMARKS
1	100K	RES	RESISTOR	100K	Ω	
2	10K	RES	RESISTOR	10K	Ω	
3	100Ω	RES	RESISTOR	100Ω	Ω	
4	100nF	CAP	CAPACITOR	100nF	nF	
5	10μF	CAP	CAPACITOR	10μF	μF	
6	100μF	CAP	CAPACITOR	100μF	μF	
7	1000μF	CAP	CAPACITOR	1000μF	μF	
8	10000μF	CAP	CAPACITOR	10000μF	μF	
9	100000μF	CAP	CAPACITOR	100000μF	μF	
10	1000000μF	CAP	CAPACITOR	1000000μF	μF	

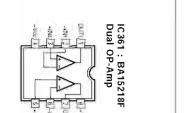
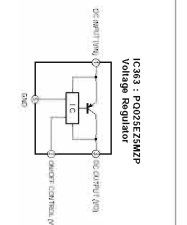
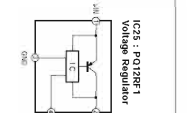
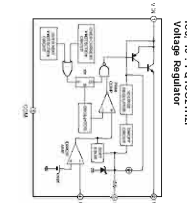
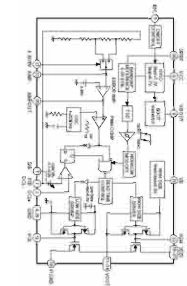

NOTICE: (continued)

- 1) All voltages are measured with a TQM01V DC electronic voltmeter.
- 2) Components having special characteristics are marked with a triangle (Δ) and must be replaced with parts having specifications equal to those originally installed.
- 3) Schematic diagram is subject to change without notice.

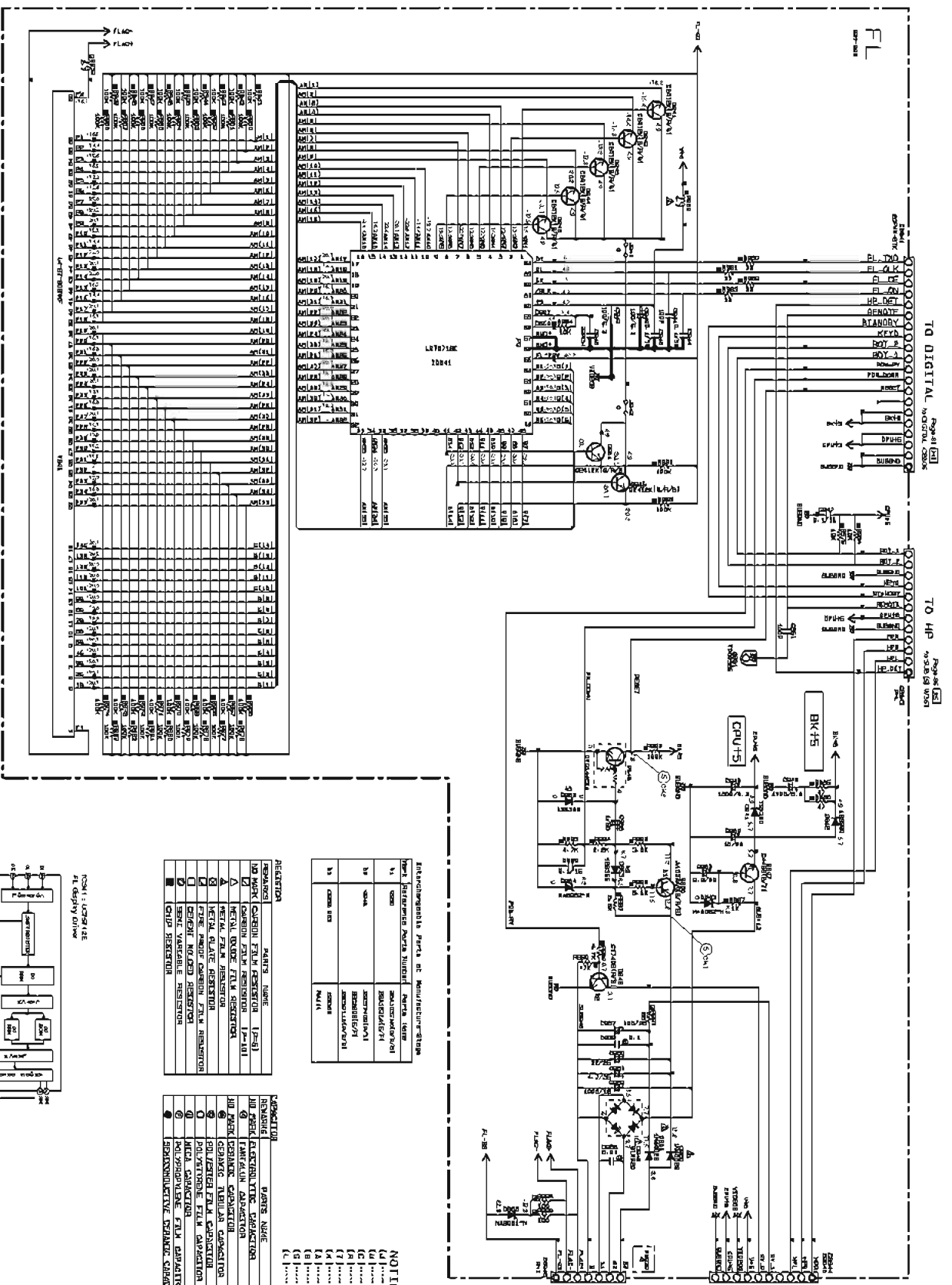

Page 41 (FL)
TO DIGITAL
DIGITAL BOARD

Page 42 (FL)
TO HP
HP BOARD

Point 5
CH1: Terminal of CS50
CH2: Connector of CS48

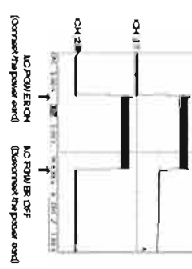

Interchangeable parts of manufacturer's items

Part No.	Part Name	Manufacturer
h1	COIN	DAIICHI DENKI
h2	COIN	DAIICHI DENKI
h3	COIN	DAIICHI DENKI

RESISTOR

Part No.	Part Name	Manufacturer
h1	COIN	DAIICHI DENKI
h2	COIN	DAIICHI DENKI
h3	COIN	DAIICHI DENKI

RESISTOR

Part No.	Part Name	Manufacturer
h1	COIN	DAIICHI DENKI
h2	COIN	DAIICHI DENKI
h3	COIN	DAIICHI DENKI

NOTICE (model)

(1) JAPAN
(2) KOREA
(3) CHINA
(4) HONG KONG
(5) TAIWAN
(6) THAILAND
(7) SINGAPORE
(8) MALAYSIA
(9) AUSTRALIA
(10) HONG KONG
(11) SINGAPORE
(12) MALAYSIA
(13) AUSTRALIA
(14) HONG KONG
(15) SINGAPORE
(16) MALAYSIA
(17) AUSTRALIA
(18) HONG KONG
(19) SINGAPORE
(20) MALAYSIA
(21) AUSTRALIA
(22) HONG KONG
(23) SINGAPORE
(24) MALAYSIA
(25) AUSTRALIA

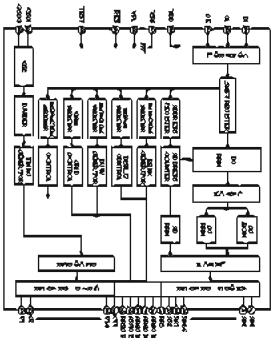

All dimensions are measured with a 150MMV DC electronic level meter.
Components having special characteristics are marked Δ and must be replaced with parts having specifications equal to those originally specified.
Schematics may differ subject to change without notice.

■ NX-SW200 SCHEMATIC DIAGRAM

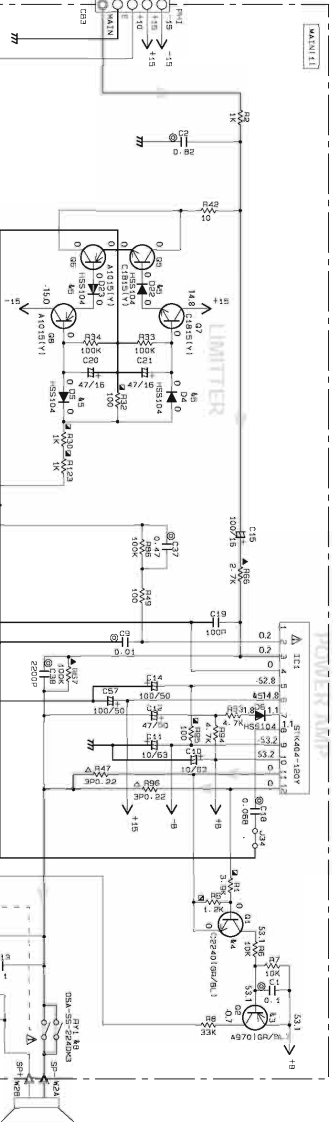
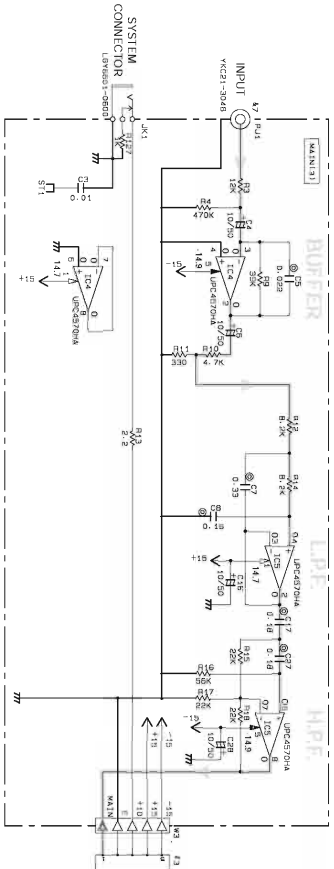

Interchangeable Parts at Manufacture-Stage

MARK	Reference Parts Number	Part's Name
41	99	2809331
42	010	2801844
43	02-4	2809218(DVBL)
44	01-3	2825281(SV7)
45	104-10-10-23	153133
46	02	153136
47	0-2	153137
48	012	153138
49	011	153139
50	010	153140
51	009	153141
52	008	153142
53	007	153143
54	006	153144
55	005	153145
56	004	153146
57	003	153147
58	002	153148
59	001	153149

NOTICE (inchi)

(J)..... JAPAN
 (U)..... U.S.A
 (C)..... CANADA
 (R)..... GENERAL
 (T)..... CHINA
 (K)..... KOREA
 (A)..... AUSTRALIA
 (O)..... OMAN
 (L)..... SINGAPORE

CAPACITOR

REMARKS	PARTS NAME
NO MARK	ELECTROLYTIC CAPACITOR
⊗	TANTALUM CAPACITOR
□	CERAMIC CAPACITOR
○	CERAMIC TUBULAR CAPACITOR
⊙	POLYESTER FILM CAPACITOR
⦶	POLYETHYLENE FILM CAPACITOR
①	MICA CAPACITOR
②	POLYPROPYLENE FILM CAPACITOR
③	SEMI-CONDUCTIVE CERAMIC CAPACITOR
④	POLYIMIDE SOLUBLE FILM CAPACITOR

RESISTOR

REMARKS	PARTS NAME
NO MARK	CARBON FILM RESISTOR [P=5]
△	CARBON FILM RESISTOR [P=10]
▽	METAL OXIDE FILM RESISTOR
◇	METAL FILM RESISTOR
⊠	METAL PLATE RESISTOR
⊞	FINE PHOS CARBON FILM RESISTOR
⊚	GENERAL PURPOSE RESISTOR
⊛	TEMPERATURE RESISTOR
⊜	DRIFT RESISTOR

POWER TRANSFORMER

LOCATION	J, U, C, H	K, A, B, G, I	DESTINATION	PART NUMBER
51	E, C	2A, 23V	T, W, 200V	X4723
52				X4724
53				X4725
54				X4726
55				X4727
56				X4728
57				X4729
58				X4730
59				X4731

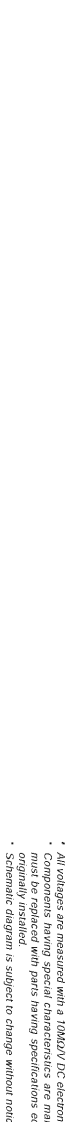
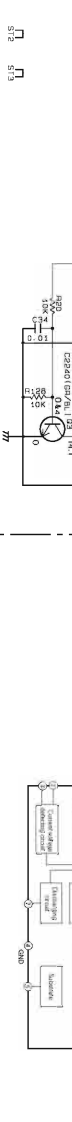
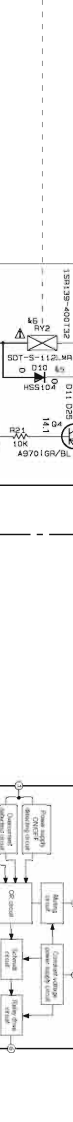
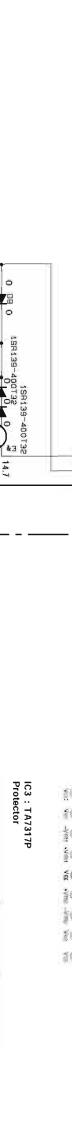
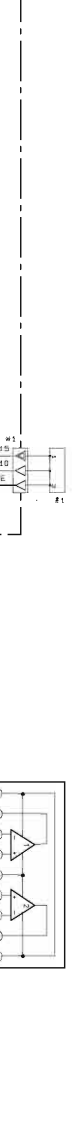
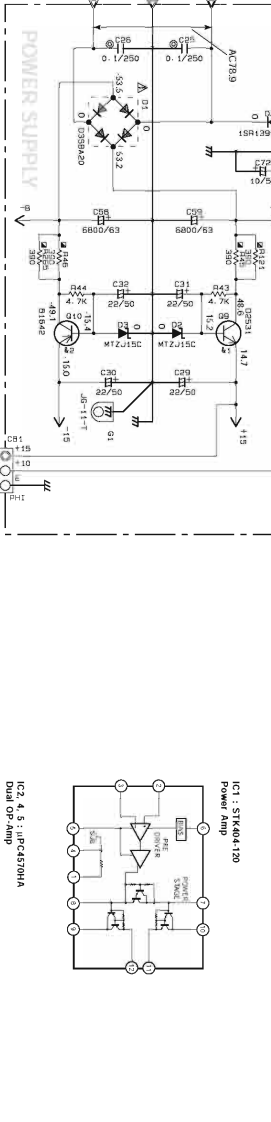

IC1 : ST4K04-120
 Power Amp

IC2, 4, 5 : 1PFC4101HA
 Dual Op-Amp

IC3 : 1TA317P
 Protector

All voltages are measured with a TOKYO DC electronic voltmeter.
 Components having special characteristics are marked Δ and must be replaced with parts having specifications equal to those originally installed.
 Schematic diagram is subject to change without notice.

PARTS LIST

■ ELECTRICAL PARTS

■ WARNING

● Components having special characteristics are marked \triangle and must be replaced with parts having specifications equal to those originally installed.

● \triangle 印のある部分は、安全確保部品を示しています。部品の交換が必要な場合、パーツリストに記載されている部品を使用してください。

ABBREVIATIONS IN THIS LIST ARE AS FOLLOWS :

C.A.EL.CHP	: CHIP ALUMI. ELECTROLYTIC CAP	L.DTCT	: LIGHT DETECTING MODULE
C.CE	: CERAMIC CAP	L.EMIT	: LIGHT EMITTING MODULE
C.CE.ARRAY	: CERAMIC CAP ARRAY	LED.DSPLY	: LED DISPLAY
C.CE.CHP	: CHIP CERAMIC CAP	LED.INFRD	: LED, INFRARED
C.CE.ML	: MULTILAYER CERAMIC CAP	MODUL.RF	: MODULATOR, RF
C.CE.M.CHP	: CHIP MULTILAYER CERAMIC CAP	PHOT.CPL	: PHOTO COUPLER
C.CE.SAFTY	: RECOGNIZED CERAMIC CAP	PHOT.INTR	: PHOTO INTERRUPTER
C.CE.TUBLR	: CERAMIC TUBULAR CAP	PHOT.RFLCT	: PHOTO REFLECTOR
C.CE.SMI	: SEMI CONDUCTIVE CERAMIC CAP	PIN.TEST	: PIN, TEST POINT
C.EL	: ELECTROLYTIC CAP	PLST.RIVET	: PLASTIC RIVET
C.MICA	: MICA CAP	R.ARRAY	: RESISTOR ARRAY
C.ML.FLM	: MULTILAYER FILM CAP	R.CAR	: CARBON RESISTOR
C.MP	: METALLIZED PAPER CAP	R.CAR.CHP	: CHIP RESISTOR
C.MYLAR	: MYLAR FILM CAP	R.CAR.FP	: FLAME PROOF CARBON RESISTOR
C.MYLAR.ML	: MULTILAYER MYLAR FILM CAP	R.FUS	: FUSABLE RESISTOR
C.PAPER	: PAPER CAPACITOR	R.MTL.CHP	: CHIP METAL FILM RESISTOR
C.PLS	: POLYSTYRENE FILM CAP	R.MTL.FLM	: METAL FILM RESISTOR
C.POL	: POLYESTER FILM CAP	R.MTL.OXD	: METAL OXIDE FILM RESISTOR
C.POLY	: POLYETHYLENE FILM CAP	R.MTL.PLAT	: METAL PLATE RESISTOR
C.PP	: POLYPROPYLENE FILM CAP	RSNR.CE	: CERAMIC RESONATOR
C.TNTL	: TANTALUM CAP	RSNR.CRYS	: CRYSTAL RESONATOR
C.TNTL.CHP	: CHIP TANTALUM CAP	R.TW.CEM	: TWIN CEMENT FIXED RESISTOR
C.TRIM	: TRIMMER CAP	R.WW	: WIRE WOUND RESISTOR
CN	: CONNECTOR	SCR.BND.HD	: BIND HEAD B-TITE SCREW
CN.BS.PIN	: CONNECTOR, BASE PIN	SCR.BW.HD	: BW HEAD TAPPING SCREW
CN.CANNON	: CONNECTOR, CANNON	SCR.CUP	: CUP TITE SCREW
CN.DIN	: CONNECTOR, DIN	SCR.TERM	: SCREW TERMINAL
CN.FLAT	: CONNECTOR, FLAT CABLE	SCR.TR	: SCREW, TRANSISTOR
CN.POST	: CONNECTOR, BASE POST	SUPRT.PCB	: SUPPORT, P.C.B.
COIL.MX.AM	: COIL, AM MIX	SURG.PRTCT	: SURGE PROTECTOR
COIL.AT.FM	: COIL, FM ANTENNA	SW.TACT	: TACT SWITCH
COIL.DT.FM	: COIL, FM DETECT	SW.LEAF	: LEAF SWITCH
COIL.MX.FM	: COIL, FM MIX	SW.LEVER	: LEVER SWITCH
COIL.OUTPT	: OUTPUT COIL	SW.MICRO	: MICRO SWITCH
DIOD.ARRAY	: DIODE ARRAY	SW.PUSH	: PUSH SWITCH
DIODE.BRG	: DIODE BRIDGE	SW.RT.ENC	: ROTARY ENCODER
DIODE.CHP	: CHIP DIODE	SW.RT.MTR	: ROTARY SWITCH WITH MOTOR
DIODE.SHOT	: SCHOTTKY BARRIER DIODE	SW.RT	: ROTARY SWITCH
DIODE.VAR	: VARACTOR DIODE	SW.SLIDE	: SLIDE SWITCH
DIOD.Z.CHP	: CHIP ZENER DIODE	TERM.SP	: SPEAKER TERMINAL
DIODE.ZENR	: ZENER DIODE	TERM.WRAP	: WRAPPING TERMINAL
DSCR.CE	: CERAMIC DISCRIMINATOR	THRMST.CHP	: CHIP THERMISTOR
FER.BEAD	: FERRITE BEADS	TR.CHP	: CHIP TRANSISTOR
FER.CORE	: FERRITE CORE	TR.DGT	: DIGITAL TRANSISTOR
FET.CHP	: CHIP FET	TR.DGT.CHP	: CHIP DIGITAL TRANSISTOR
FL.DSPLY	: FLUORESCENT DISPLAY	TRANS	: TRANSFORMER
FLTR.CE	: CERAMIC FILTER	TRANS.PULS	: PULSE TRANSFORMER
FLTR.COMB	: COMB FILTER MODULE	TRANS.PWR	: POWER TRANSFORMER ASS'y
FLTR.LC.RF	: LC FILTER ,EMI	TUNER.AM	: TUNER PACK, AM
GND.MTL	: GROUND PLATE	TUNER.FM	: TUNER PACK, FM
GND.TERM	: GROUND TERMINAL	TUNER.PK	: FRONT-END TUNER PACK
HOLDER.FUS	: FUSE HOLDER	VR	: ROTARY POTENTIOMETER
IC.PRTCT	: IC PROTECTOR	VR.MTR	: POTENTIOMETER WITH MOTOR
JUMPER.CN	: JUMPER CONNECTOR	VR.SW	: POTENTIOMETER WITH ROTARY SW
JUMPER.TST	: JUMPER, TEST POINT	VR.SLIDE	: SLIDE POTENTIOMETER
		VR.TRIM	: TRIMMER POTENTIOMETER

DVR-S200 P.C.B. DIGITAL

Ref. No.	PART NO.	Description	Remarks	Markets	部品名	Rank	
*	WC002600	P. C. B.	DIGITAL		J	P C B デジタル	
*	WC002700	P. C. B.	DIGITAL		UCRKABGL	P C B デジタル	
*	CB301	WA903600	CN 36P SE FMN			FMNコネクター	
*	CB302	WC198000	CN 30P TE FMN			FMNコネクター	
*	CB303	WC195900	CN 9P TE FMN			FMNコネクター	
*	CB304	WC195900	CN 9P TE FMN			FMNコネクター	
*	CB305	WC199000	CN 40P TE FMN			FMNコネクター	
*	CB306	WA902000	CN 20P SE FMN			FMNコネクター	
*	CB307	WC198000	CN 30P TE FMN			FMNコネクター	
*	CB308	WA903000	CN 30P SE FMN			FMNコネクター	
*	CB309	WA900800	CN 8P SE FMN			FMNコネクター	
	D301	VV220700	DIODE. SHOT RB501V-40			ショットキーダイオード	01
	D302	VV220700	DIODE. SHOT RB501V-40			ショットキーダイオード	01
	D303	VV220700	DIODE. SHOT RB501V-40			ショットキーダイオード	01
	D304	VV220700	DIODE. SHOT RB501V-40			ショットキーダイオード	01
	D307	VU992600	DIODE. ZENR MA8051-M 5. 1V			ツェナーダイオード	01
	D308	VU992600	DIODE. ZENR MA8051-M 5. 1V			ツェナーダイオード	01
	D309	VU992600	DIODE. ZENR MA8051-M 5. 1V			ツェナーダイオード	01
	G301	WB438000	TERM. GND M4 SD00433-21			アース端子	
	G302	WB438000	TERM. GND M4 SD00433-21			アース端子	
	G303	WB438000	TERM. GND M4 SD00433-21			アース端子	
	G374	WB438000	TERM. GND M4 SD00433-21			アース端子	
	IC301	XV077B00	IC MSM514260E-60JS			メモリIC 4M	07
	IC302	X4075B00	IC XC9572XL-10Q100C	J		IC	07
	IC303	X0238B00	IC Y55938			IC	13
	IC304	X3473A00	IC CS493292-CLR	J		IC	15
	IC305	X2828A00	IC CS4382-KQR			IC	08
*	IC306	X3782A00	IC CS5351-KSR			IC	06
*	IC307	X4425A00	IC. CPU M38517F8FP	EPROM WRITTEN		書込済EPROM	
*	IC308	X4766A00	IC. CPU M30624FGFP	EPROM WRITTEN		書込済EPROM	
	IC371	XW433A00	IC CY62256LL-70SNCT		J	メモリIC 256K	05
	IC374	XZ012A00	IC TC74HCT08AF (EL)			ロジックIC SOP	01
	IC611	X3505A00	IC NJM2068MD-TE2			アンプIC SOP	02
	IC613	X3505A00	IC NJM2068MD-TE2			アンプIC SOP	02
	IC614	X3505A00	IC NJM2068MD-TE2			アンプIC SOP	02
	IC615	X3505A00	IC NJM2068MD-TE2			アンプIC SOP	02
	IC616	X3505A00	IC NJM2068MD-TE2			アンプIC SOP	02
	IC618	XY070A00	IC MM74HCU04S JX INVER			ロジックIC SOP	01
*	IC619	XY119A00	IC MM74HCT00S JX NAND			ロジックIC SOP	01
	Q304	VV655700	TR. DGT DTC144EKA			デジタルトランジスタ	01
	Q305	VV556400	TR 2SC2412K Q, R, S			トランジスタ	01
	Q306	VV655300	TR. DGT DTA144EKA			デジタルトランジスタ	01
	Q307	VV556400	TR 2SC2412K Q, R, S			トランジスタ	01
	XL301	V3625700	RSNR. CRYSTAL 24. 576MHz			水晶振動子	03
*	XL302	WB872100	RSNR. CRYSTAL 16. 9344M SMD-49			水晶振動子	
*	XL304	WB440500	RSNR. CE CSTCE16MOV53-R0			セラミック発振子	01

* New Parts (新規部品)

Note) Those parts marked with “#” are not included in the P.C.B. ass'y. (マーク#の部品は、基板に含まれません)

DVR-S200 P.C.B. MAIN

Ref. No.	PART NO.	Description	Remarks	Markets	部品名	Rank	
*	WC001600	P. C. B.	MAIN		J	P C B メイン	
*	WC001700	P. C. B.	MAIN		UCRKAL	P C B メイン	
*	WC001800	P. C. B.	MAIN		BG	P C B メイン	
	CB101	LB918050	CN. BS. PIN	5P		ベース付ポスト	01
	CB102	VB389800	CN. BS. PIN	2P		ベースピン	01
*	CB103	WA545900	CN	30P TE FMN		F F C / F P C コネクタ	01
	CB104	VQ963000	CN. BS. PIN	9P		ウエハー	01
	CB105	VQ962900	CN. BS. PIN	8P		ウエハー	01
*	CB106	V7543200	CN. BS. PIN	36P TE FMN		F F C コネクタ	02
	CB107	VQ963000	CN. BS. PIN	9P		ウエハー	01
	CB108	VQ962900	CN. BS. PIN	8P		ウエハー	01
	CB109	VQ963000	CN. BS. PIN	9P		ウエハー	01
	CB110	VQ962900	CN. BS. PIN	8P		ウエハー	01
	CB111	VB390400	CN. BS. PIN	8P		ベースピン	01
	CB112	VQ963000	CN. BS. PIN	9P		ウエハー	01
	CB113	VQ962900	CN. BS. PIN	8P		ウエハー	01
	CB114	VQ963000	CN. BS. PIN	9P		ウエハー	01
	CB115	VQ962900	CN. BS. PIN	8P		ウエハー	01
*	CB116	V7827000	CN	20P TE TUC SERIES		コネクタプラグ	01
	CB117	V7825400	CN	4P TE TUC SERIES		コネクタプラグ	01
	CB118	LB918020	CN. BS. PIN	2P		ベース付ポスト	01
	CB119	VB389900	CN. BS. PIN	3P TE		ウエハー	01
	CB801	V7684100	CN	14P SE YKF SERIES	J	D 端子コネクタ	
	CB802	VQ044600	CN. BS. PIN	13P	JUCRKAL	F F C コネクタ	01
*	CB803	WB497000	CN. BS. PIN	40P TE FMN	JUCRKAL	F F C コネクタ	
*	CB871	WB497100	CN	21P YKF41-5044	BG	R G B コネクタ	
*	CB872	WB497000	CN. BS. PIN	40P TE FMN	BG	F F C コネクタ	
	CB873	VQ044600	CN. BS. PIN	13P	BG	F F C コネクタ	01
	C109	UM416220	C. EL	2. 2uF 50V		ケミコン	01
	C110	UM416220	C. EL	2. 2uF 50V		ケミコン	01
	C111	UM416220	C. EL	2. 2uF 50V		ケミコン	01
	C112	UM416220	C. EL	2. 2uF 50V		ケミコン	01
	C117	UM407100	C. EL	10uF 50V		ケミコン	01
	C119	UM407100	C. EL	10uF 50V		ケミコン	01
	C121	UR857100	C. EL	10uF 35V		ケミコン	01
	C122	UM416220	C. EL	2. 2uF 50V		ケミコン	01
	C123	UM416220	C. EL	2. 2uF 50V		ケミコン	01
	C134	UM416470	C. EL	4. 7uF 50V		ケミコン	01
	C135	UM416470	C. EL	4. 7uF 50V		ケミコン	01
	C136	UM416470	C. EL	4. 7uF 50V		ケミコン	01
	C137	UM416470	C. EL	4. 7uF 50V		ケミコン	01
	C138	UM416470	C. EL	4. 7uF 50V		ケミコン	01
	C139	UM416470	C. EL	4. 7uF 50V		ケミコン	01
	C140	UM397470	C. EL	47uF 16V		ケミコン	01
	C141	UM397470	C. EL	47uF 16V		ケミコン	01
	C142	UR857100	C. EL	10uF 35V		ケミコン	01
	C145	UM397100	C. EL	10uF 16V		ケミコン	01
	C146	UM397100	C. EL	10uF 16V		ケミコン	01
	C147	UM397100	C. EL	10uF 16V		ケミコン	01
	C148	UM397100	C. EL	10uF 16V		ケミコン	01
	C149	UM397100	C. EL	10uF 16V		ケミコン	01
	C150	UM397100	C. EL	10uF 16V		ケミコン	01
	C154	UM397100	C. EL	10uF 16V		ケミコン	01

* New Parts (新規部品)

Note) Those parts marked with "#" are not included in the P.C.B. ass'y. (マーク#の部品は、基板に含まれません)

DVR-S200 P.C.B. MAIN

Ref. No.	PART NO.	Description	Remarks	Markets	部品名	Rank
C155	UM397100	C. EL 10uF 16V			ケミコン	01
C156	UM397100	C. EL 10uF 16V			ケミコン	01
C157	UM397470	C. EL 47uF 16V			ケミコン	01
C158	UM397470	C. EL 47uF 16V			ケミコン	01
C161	UM398100	C. EL 100uF 16V			ケミコン	01
C162	UM398100	C. EL 100uF 16V			ケミコン	01
C166	UR837470	C. EL 47uF 16V			ケミコン	01
C167	UM397100	C. EL 10uF 16V			ケミコン	01
C168	UM397100	C. EL 10uF 16V			ケミコン	01
C169	UM397100	C. EL 10uF 16V			ケミコン	01
C170	UM397100	C. EL 10uF 16V			ケミコン	01
C171	UM397100	C. EL 10uF 16V			ケミコン	01
C172	UM397100	C. EL 10uF 16V			ケミコン	01
C176	UR837470	C. EL 47uF 16V			ケミコン	01
C177	UR857100	C. EL 10uF 35V			ケミコン	01
C178	UR837470	C. EL 47uF 16V			ケミコン	01
C185	UR857100	C. EL 10uF 35V			ケミコン	01
C186	UR837470	C. EL 47uF 16V			ケミコン	01
C187	UR837470	C. EL 47uF 16V			ケミコン	01
C188	UR838100	C. EL 100uF 16V			ケミコン	01
C189	UR838100	C. EL 100uF 16V			ケミコン	01
C190	UR838100	C. EL 100uF 16V			ケミコン	01
C191	UR857100	C. EL 10uF 35V			ケミコン	01
C192	UM407100	C. EL 10uF 50V			ケミコン	01
C193	UM407100	C. EL 10uF 50V			ケミコン	01
C194	UM407100	C. EL 10uF 50V			ケミコン	01
C195	UM407100	C. EL 10uF 50V			ケミコン	01
C196	UM407100	C. EL 10uF 50V			ケミコン	01
C201	UR857100	C. EL 10uF 35V			ケミコン	01
C204	UN865470	C. EL 0.47uF 50V			B P ケミコン	01
C208	UA652100	C. MYLAR 100pF 50V			マイラーコン	01
C219	UM397100	C. EL 10uF 16V			ケミコン	01
C220	UM397100	C. EL 10uF 16V			ケミコン	01
C221	UM397100	C. EL 10uF 16V			ケミコン	01
C222	UM397100	C. EL 10uF 16V			ケミコン	01
C231	UM407100	C. EL 10uF 50V			ケミコン	01
C232	UM407100	C. EL 10uF 50V			ケミコン	01
C233	UN865470	C. EL 0.47uF 50V			B P ケミコン	01
C307	UM397470	C. EL 47uF 16V			ケミコン	01
C308	UM397470	C. EL 47uF 16V			ケミコン	01
C311	UR819100	C. EL 1000uF 6.3V			ケミコン	01
C804	UR837100	C. EL 10uF 16V		JUCRKAL	ケミコン	01
C805	UR837100	C. EL 10uF 16V		JUCRKAL	ケミコン	01
C806	UR837100	C. EL 10uF 16V		JUCRKAL	ケミコン	01
C809	UR837100	C. EL 10uF 16V		JUCRKAL	ケミコン	01
C813	UR837470	C. EL 47uF 16V		JUCRKAL	ケミコン	01
C814	UR837470	C. EL 47uF 16V		JUCRKAL	ケミコン	01
C815	UR857100	C. EL 10uF 35V		JUCRKAL	ケミコン	01
C816	UR857100	C. EL 10uF 35V		JUCRKAL	ケミコン	01
C817	UR857100	C. EL 10uF 35V		JUCRKAL	ケミコン	01
C818	UR728470	C. EL 470uF 10V		JUCRKAL	ケミコン	01
C819	UR857100	C. EL 10uF 35V		JUCRKAL	ケミコン	01
C820	UR857100	C. EL 10uF 35V		JUCRKAL	ケミコン	01

* New Parts (新規部品)

Note) Those parts marked with “#” are not included in the P.C.B. ass'y. (マーク#の部品は、基板に含まれません)

DVR-S200 P.C.B. MAIN

Ref. No.	PART NO.	Description	Remarks	Markets	部品名	Rank
C829	UR837470	C. EL	47uF 16V		JUCRKAL ケミコン	01
C830	UR837470	C. EL	47uF 16V		JUCRKAL ケミコン	01
C831	UR837470	C. EL	47uF 16V		JUCRKAL ケミコン	01
C832	UR837470	C. EL	47uF 16V		JUCRKAL ケミコン	01
C834	UR847330	C. EL	33uF 25V		JUCRKAL ケミコン	01
C836	UR866220	C. EL	2. 2uF 50V		JUCRKAL ケミコン	01
C838	UR847330	C. EL	33uF 25V		JUCRKAL ケミコン	01
C874	UR837100	C. EL	10uF 16V	BG	ケミコン	01
C875	UR837100	C. EL	10uF 16V	BG	ケミコン	01
C881	UR837470	C. EL	47uF 16V	BG	ケミコン	01
C884	UR817470	C. EL	47uF 6. 3V	BG	ケミコン	01
C887	UR837470	C. EL	47uF 16V	BG	ケミコン	01
C890	UR837470	C. EL	47uF 16V	BG	ケミコン	01
C891	UR837470	C. EL	47uF 16V	BG	ケミコン	01
C892	UR857100	C. EL	10uF 35V	BG	ケミコン	01
C893	UR857100	C. EL	10uF 35V	BG	ケミコン	01
C894	UR857100	C. EL	10uF 35V	BG	ケミコン	01
C895	UR728470	C. EL	470uF 10V	BG	ケミコン	01
C896	UR857100	C. EL	10uF 35V	BG	ケミコン	01
C897	UR857100	C. EL	10uF 35V	BG	ケミコン	01
C898	UR837470	C. EL	47uF 16V	BG	ケミコン	01
C902	UR837470	C. EL	47uF 16V	BG	ケミコン	01
C903	UR837470	C. EL	47uF 16V	BG	ケミコン	01
C907	UR837470	C. EL	47uF 16V	BG	ケミコン	01
C908	UR837470	C. EL	47uF 16V	BG	ケミコン	01
C910	UR837470	C. EL	47uF 16V	BG	ケミコン	01
C912	UR837470	C. EL	47uF 16V	BG	ケミコン	01
C914	UR847330	C. EL	33uF 25V	BG	ケミコン	01
C915	UR866220	C. EL	2. 2uF 50V	BG	ケミコン	01
C918	UR847330	C. EL	33uF 25V	BG	ケミコン	01
C922	UR847330	C. EL	33uF 25V	BG	ケミコン	01
C924	UR866220	C. EL	2. 2uF 50V	BG	ケミコン	01
C926	UR847330	C. EL	33uF 25V	BG	ケミコン	01
C929	UR837100	C. EL	10uF 16V		ケミコン	
C930	UR837100	C. EL	10uF 16V		ケミコン	
D102	VU993900	DIODE. ZENR	MA8068-L 7. 0V		ツェナーダイオード	
D103	VU993900	DIODE. ZENR	MA8068-L 7. 0V		ツェナーダイオード	
D104	VT332900	DIODE	1SS355		ダイオード	01
D105	VU996200	DIODE. ZENR	MA8120-M 12. 0V		ツェナーダイオード	01
D106	VU996200	DIODE. ZENR	MA8120-M 12. 0V		ツェナーダイオード	01
* D107	VU995800	DIODE. ZENR	MA8110-M 11. 0V		ツェナーダイオード	
* D108	VU995800	DIODE. ZENR	MA8110-M 11. 0V		ツェナーダイオード	
* D109	VU995800	DIODE. ZENR	MA8110-M 11. 0V		ツェナーダイオード	
* D110	VU995800	DIODE. ZENR	MA8110-M 11. 0V		ツェナーダイオード	
* D111	VU995800	DIODE. ZENR	MA8110-M 11. 0V		ツェナーダイオード	
D301	VV220700	DIODE. SHOT	RB501V-40		ショットキーダイオード	01
D302	VV220700	DIODE. SHOT	RB501V-40		ショットキーダイオード	01
D303	VU995800	DIODE. ZENR	MA8110-M 11. 0V		ツェナーダイオード	01
△ D801	VU995000	DIODE. ZENR	MA8091-M 9. 1V	JUCRKAL	ツェナーダイオード	
△ D871	VU993000	DIODE. ZENR	MA8056-M 5. 6V	BG	ツェナーダイオード	01
△ D872	VU995000	DIODE. ZENR	MA8091-M 9. 1V	BG	ツェナーダイオード	
IC101	X3547A00	IC	BD3841FS		IC	
IC102	XJ757A00	IC	NJM78L05A-T3		IC	01

* New Parts (新規部品)

Note) Those parts marked with "#" are not included in the P.C.B. ass'y. (マーク#の部品は、基板に含まれません)

DVR-S200 P.C.B. MAIN

Ref. No.	PART NO.	Description	Remarks	Markets	部品名	Rank
IC103	XF291A00	IC	uPC4570G2		IC	03
IC106	XZ545A00	IC	YAC520-EE2		IC	04
IC107	XZ545A00	IC	YAC520-EE2		IC	04
IC108	XZ545A00	IC	YAC520-EE2		IC	04
IC109	X3905A00	IC	TS7ST08F AND		ロジックIC	01
IC111	XF291A00	IC	uPC4570G2		IC	03
IC112	XF291A00	IC	uPC4570G2		IC	03
IC113	XF291A00	IC	uPC4570G2		IC	03
IC301	XY120A00	IC	TC74HCT00AF(EL) NA		ロジックIC SOP	01
IC302	XR038A00	IC	NJM2904M OP AMP		IC	01
IC801	X2875A00	IC	NJM2595D	JUCRKAL	IC	05
IC802	XZ177A00	IC	LA7104M VIDEO AMP	JUCRKAL	アンプIC SOP	04
IC803	XW911A00	IC	LA7108M VIDEO AMP	JUCRKAL	アンプIC	04
IC861	XY443A00	IC	LA7109 6CH	BG	アンプIC SOP	05
IC862	XY879A00	IC	TC74HC4053AF(EL)	BG	ロジックIC SOP	03
IC863	XZ177A00	IC	LA7104M VIDEO AMP	BG	アンプIC SOP	04
IC864	XY534A00	IC	LC72722	BG	RDSデコーダIC	06
IC865	X2875A00	IC	NJM2595D	BG	IC	05
JK301	VJ726800	JACK. MNI			モノラルミニジャック	01
JK801	VS867300	CN. DIN	4P YKF51-5501	JUCRKAL	DINコネクタ	03
JK871	VS867300	CN. DIN	4P YKF51-5501	BG	DINコネクタ	03
L305	Vi491100	FER. CORE	BP53RB190120080M	UCRKABGL	フェライトコア	
PJ101	V7046700	JACK. PIN	4P MSP-244V1-01NI		ピンジャック	
PJ102	V8502200	JACK. PIN	2P MSP-242V3-01NI	JUCRKAL	ピンジャック	02
PJ103	VV306800	JACK. PIN	1P		ピンジャック	02
PJ104	V7046800	JACK. PIN	6P MSP-246V1-01NI		ピンジャック	
PJ801	V2773400	JACK. PIN	1P	JUCRKAL	ピンジャック	02
PJ802	V6222700	JACK. PIN	3P	UCRKAL	ピンジャック	03
PJ803	VV325000	JACK. PIN	2P	JUCRKAL	ピンジャック	03
PJ804	VV325000	JACK. PIN	2P	JUCRKAL	ピンジャック	03
* PJ871	WB385300	JACK. PIN	3P YKC21-4195N	BG	ピンジャック	
PJ872	VV325000	JACK. PIN	2P	BG	ピンジャック	03
PJ873	VV325000	JACK. PIN	2P	BG	ピンジャック	03
Q102	VV556400	TR	2SC2412K Q, R, S		トランジスタ	01
Q103	VV556400	TR	2SC2412K Q, R, S		トランジスタ	01
Q104	VV556400	TR	2SC2412K Q, R, S		トランジスタ	01
Q107	VV556400	TR	2SC2412K Q, R, S		トランジスタ	01
Q108	VV556400	TR	2SC2412K Q, R, S		トランジスタ	01
Q109	VV556400	TR	2SC2412K Q, R, S		トランジスタ	01
Q110	VV655000	TR. DGT	DTA114EKA		デジタルトランジスタ	01
Q111	VZ725900	TR	2SD1938F S, T		トランジスタ	
Q112	VV655400	TR. DGT	DTC114EKA		デジタルトランジスタ	01
Q113	VV655400	TR. DGT	DTC114EKA		デジタルトランジスタ	01
Q114	VV655000	TR. DGT	DTA114EKA		デジタルトランジスタ	01
Q115	Vi334100	TR	2SD1760 F5 P, Q, R		トランジスタ	01
Q116	Vi334100	TR	2SD1760 F5 P, Q, R		トランジスタ	01
Q117	Vi334100	TR	2SD1760 F5 P, Q, R		トランジスタ	01
Q118	Vi334100	TR	2SD1760 F5 P, Q, R		トランジスタ	01
Q119	Vi334100	TR	2SD1760 F5 P, Q, R		トランジスタ	01
Q120	VZ725900	TR	2SD1938F S, T		トランジスタ	
Q121	VZ725900	TR	2SD1938F S, T		トランジスタ	
Q122	VZ725900	TR	2SD1938F S, T		トランジスタ	
Q123	VZ725900	TR	2SD1938F S, T		トランジスタ	

* New Parts (新規部品)

DVR-S200 P.C.B. MAIN & SUB

Ref. No.	PART NO.	Description	Remarks	Markets	部品名	Rank
Q124	VZ725900	TR	2SD1938F S, T		トランジスタ	
Q125	VZ725900	TR	2SD1938F S, T		トランジスタ	
Q301	VV655700	TR. DGT	DTC144EKA		デジタルトランジスタ	01
Q302	VV655700	TR. DGT	DTC144EKA		デジタルトランジスタ	01
Q303	VP872700	TR	2SC4488 S, T		トランジスタ	01
Q801	VV655400	TR. DGT	DTC114EKA	J	デジタルトランジスタ	01
Q802	VV655400	TR. DGT	DTC114EKA	J	デジタルトランジスタ	01
Q803	VV655500	TR. DGT	DTC124EKA	J	デジタルトランジスタ	01
Q804	VV655500	TR. DGT	DTC124EKA	J	デジタルトランジスタ	01
△ Q805	VP872700	TR	2SC4488 S, T	JUCRKAL	トランジスタ	01
Q871	VV556500	TR	2SA1037K Q, R, S	BG	トランジスタ	01
Q872	VV556400	TR	2SC2412K Q, R, S	BG	トランジスタ	01
Q873	VV556400	TR	2SC2412K Q, R, S	BG	トランジスタ	01
Q874	VV556400	TR	2SC2412K Q, R, S	BG	トランジスタ	01
Q875	VV556400	TR	2SC2412K Q, R, S	BG	トランジスタ	01
Q876	VV655700	TR. DGT	DTC144EKA	BG	デジタルトランジスタ	01
△ Q877	VC218900	TR	2SC3330 R, S, T	BG	トランジスタ	01
△ Q878	VP872700	TR	2SC4488 S, T	BG	トランジスタ	01
R169	HV754100	R. CAR. FP	10Ω 1/4W		不燃化カーボン抵抗	01
R170	HV754100	R. CAR. FP	10Ω 1/4W		不燃化カーボン抵抗	01
R177	HV755390	R. CAR. FP	390Ω 1/4W		不燃化カーボン抵抗	01
R178	HV755390	R. CAR. FP	390Ω 1/4W		不燃化カーボン抵抗	01
R189	HV753470	R. CAR. FP	4.7Ω 1/4W		不燃化カーボン抵抗	01
R201	HV754100	R. CAR. FP	10Ω 1/4W		不燃化カーボン抵抗	01
R202	HV754100	R. CAR. FP	10Ω 1/4W		不燃化カーボン抵抗	01
R240	VP940900	R. MTL. OXD	560Ω 1W		酸化金属被膜抵抗	
R241	VP940900	R. MTL. OXD	560Ω 1W		酸化金属被膜抵抗	
R242	VP940900	R. MTL. OXD	560Ω 1W		酸化金属被膜抵抗	
R243	VP940900	R. MTL. OXD	560Ω 1W		酸化金属被膜抵抗	
R244	VP940900	R. MTL. OXD	560Ω 1W		酸化金属被膜抵抗	
R310	HV756560	R. CAR. FP	5.6KΩ 1/4W		不燃化カーボン抵抗	01
R311	HV755100	R. CAR. FP	100Ω 1/4W		不燃化カーボン抵抗	01
R315	WB784200	R. MTL. OXD	1.5Ω 1W		金属被膜抵抗	01
R320	WB784200	R. MTL. OXD	1.5Ω 1W		金属被膜抵抗	01
R907	HV755220	R. CAR. FP	220Ω 1/4W		不燃化カーボン抵抗	01
* TE101	WB244100	TERM. SP	NLA1-01-004		スピーカー端子	
* TH101	WC310100	THRMST	NTSA0WF104FN6A0		温度検知用サーミスタ	
* U301	WB001400	CN. PHOT. SN	1P GP1FA553RZ		光ファイバ受信器	
* U302	WB001600	CN. PHOT. SN	1P GP1FA553TZ		光ファイバリンク	
XL871	V3930900	RSNR. CRYST	4.332MHz	BG	水晶振動子	05
* * * * *	WC001900	P. C. B.	SUB	J	P C B 集成 サブ	
* * * * *	WC002000	P. C. B.	SUB	UC	P C B 集成 サブ	
* * * * *	WC002100	P. C. B.	SUB	R	P C B 集成 サブ	
* * * * *	WC002200	P. C. B.	SUB	K	P C B 集成 サブ	
* * * * *	WC002300	P. C. B.	SUB	A	P C B 集成 サブ	
* * * * *	WC002400	P. C. B.	SUB	BG	P C B 集成 サブ	
* * * * *	WC002500	P. C. B.	SUB	L	P C B 集成 サブ	
CB1	V7826100	CN	11P TE TUC SERIES		コネクタープラグ	01
CB2	V7826400	CN	14P TE TUC SERIES		コネクタープラグ	
CB3	VG879900	CN. BS. PIN	2P		ベースピン	01

* New Parts (新規部品)

Note) Those parts marked with "#" are not included in the P.C.B. ass'y. (マーク#の部品は、基板に含まれません)

DVR-S200 P.C.B. SUB

Ref. No.	PART NO.	Description	Remarks	Markets	部品名	Rank
CB4	VT807100	CN. BS. PIN 2P			ベースポスト	01
CB6	LB918040	CN. BS. PIN 4P			ベース付ポスト	01
CB7	VL844700	CN. BS. PIN 3P			ベース付ポスト	01
CB8	LB918050	CN. BS. PIN 5P			ベース付ポスト	01
CB351	VB858500	CN. BS. PIN 6P			ベースピン	01
CB361	V7827100	SOCKET 4P TE TUC SERIES			コネクターソケット	
CB362	VM688900	CN. BS. PIN 10P			FFCコネクター	01
* CB363	V7828700	SOCKET 20P SE TUC SERIES			コネクターソケット	01
CB364	V7827800	SOCKET 11P SE TUC SERIES			コネクターソケット	
CB365	V7828100	SOCKET 14P TE TUC SERIES			コネクターソケット	
* CB366	V6217800	CN. BS. PIN 8P TE FMN			FFCコネクター	01
C1	UA654100	C. MYLAR 0.01uF 50V			マイラーコン	01
C2	UR838100	C. EL 100uF 16V			ケミコン	01
C3	VR193400	C. OS 10uF 25V			OSコン	03
C6	UR819100	C. EL 1000uF 6.3V			ケミコン	01
C7	UR838100	C. EL 100uF 16V			ケミコン	01
C8	UR838100	C. EL 100uF 16V			ケミコン	01
C9	UR838330	C. EL 330uF 16V			ケミコン	01
C10	UR838100	C. EL 100uF 16V			ケミコン	01
C11	UR838100	C. EL 100uF 16V			ケミコン	01
C12	UR867470	C. EL 47uF 50V			ケミコン	01
△ C14	V6185300	C. CE. SAFTY 0.01uF 275V			規格認定コン	
C15	UR847100	C. EL 10uF 25V			ケミコン	01
C16	UR847100	C. EL 10uF 25V			ケミコン	01
C20	UR847470	C. EL 47uF 25V			ケミコン	01
C21	UR867470	C. EL 47uF 50V			ケミコン	01
C22	UR847100	C. EL 10uF 25V			ケミコン	01
C23	UR847100	C. EL 10uF 25V			ケミコン	01
C24	UR819100	C. EL 1000uF 6.3V			ケミコン	01
C27	UR867220	C. EL 22uF 50V			ケミコン	01
C28	VR193400	C. OS 10uF 25V			OSコン	03
C32	UR848100	C. EL 100uF 25V			ケミコン	01
C33	UR749220	C. EL 2200uF 25V			ケミコン	03
C34	UR749220	C. EL 2200uF 25V			ケミコン	03
C36	UR818470	C. EL 470uF 6.3V			ケミコン	01
C37	UR739680	C. EL 6800uF 16V			ケミコン	
C38	UR739470	C. EL 4700uF 16V			ケミコン	02
C39	VV205900	C. EL 6800uF 50V			ケミコン	07
C40	VV205900	C. EL 6800uF 50V			ケミコン	07
C41	UR749220	C. EL 2200uF 25V			ケミコン	03
C43	V7409000	C. EL 180uF 16V			ケミコン	02
C44	UR838100	C. EL 100uF 16V			ケミコン	01
C46	UA654470	C. MYLAR 0.047uF 50V			マイラーコン	01
C47	UA654470	C. MYLAR 0.047uF 50V			マイラーコン	01
C48	UR818330	C. EL 330uF 6.3V			ケミコン	01
C51	UR837330	C. EL 33uF 16V			ケミコン	01
C52	VT898000	C. POL 0.1uF 100V			マイラーコン	01
C53	VT898000	C. POL 0.1uF 100V			マイラーコン	01
C54	UR749220	C. EL 2200uF 25V			ケミコン	03
C55	VR168300	C. MYLAR. ML ECQ-V1H104JL3			積層マイラーコン	01
C351	UM388100	C. EL 100uF 10V			ケミコン	01
C361	UN865470	C. EL 0.47uF 50V			B P ケミコン	01
C362	UR857100	C. EL 10uF 35V			ケミコン	01

* New Parts (新規部品)

DVR-S200 P.C.B. SUB

Ref. No.	PART NO.	Description	Remarks	Markets	部品名	Rank
C363	UR857100	C. EL	10uF 35V		ケミコン	01
C364	UR837100	C. EL	10uF 16V		ケミコン	01
C365	UR837100	C. EL	10uF 16V		ケミコン	01
C366	UR838100	C. EL	100uF 16V		ケミコン	01
C367	UR838100	C. EL	100uF 16V		ケミコン	01
C374	UR838470	C. EL	470uF 16V		ケミコン	01
C375	UR838470	C. EL	470uF 16V		ケミコン	01
C376	UR818100	C. EL	100uF 6.3V		ケミコン	01
C379	UM388330	C. EL	330uF 6.3V		ケミコン	01
C381	UR819100	C. EL	1000uF 6.3V		ケミコン	01
C384	UR818470	C. EL	470uF 6.3V		ケミコン	01
D1	VU996200	DIODE. ZENR	MA8120-M 12.0V		ツェナーダイオード	01
D2	V6267600	DIODE	RB051L-40		ダイオード	01
D3	VV220700	DIODE. SHOT	RB501V-40		ショットキーダイオード	01
D4	VU998600	DIODE. ZENR	MA8220-L 21.3V		ツェナーダイオード	01
D5	VT332900	DIODE	1SS355		ダイオード	01
D6	VT332900	DIODE	1SS355		ダイオード	01
D7	V6267600	DIODE	RB051L-40		ダイオード	01
△ D8	V6855600	DIODE. BRG	D4SBS4-4101 4A		ダイオードブリッジ	03
△ D9	V6855600	DIODE. BRG	D4SBS4-4101 4A		ダイオードブリッジ	03
△ D10	VV307700	DIODE	1N4002S		ダイオード	01
△ D11	VV307700	DIODE	1N4002S		ダイオード	01
△ D12	VR253700	DIODE. BRG	S1NB20 1A 200V		D1ブリッジ X4	02
D13	V6267600	DIODE	RB051L-40		ダイオード	01
△ D14	VQ111400	DIODE. BRG	D5SBA20-4001 6A		ダイオードブリッジ	03
D15	VT332900	DIODE	1SS355		ダイオード	01
D16	VT332900	DIODE	1SS355		ダイオード	01
△ D17	VV307700	DIODE	1N4002S		ダイオード	01
D18	VT332900	DIODE	1SS355		ダイオード	01
D361	VT332900	DIODE	1SS355		ダイオード	01
D362	VT332900	DIODE	1SS355		ダイオード	01
D363	VT332900	DIODE	1SS355		ダイオード	01
D364	VT332900	DIODE	1SS355		ダイオード	01
D365	VT332900	DIODE	1SS355		ダイオード	01
D366	VT332900	DIODE	1SS355		ダイオード	01
△* F11	WB754600	FLTR	ELF15N030A	UC	ラインフィルター	
△* F11	WC362100	FLTR	ELF15N050A	JRKABGL	ラインフィルター	
G3	V5995800	PLATE. GND			アースプレート	
G351	V4040500	SCR. TERM	M3		スクリュー/ターミナル	01
△ IC1	XJ608A00	IC	NJM7812FA		IC	02
△ IC2	XD343A00	IC	NJM79M12FA		IC	03
△ IC3	XJ604A00	IC	NJM78M05FA		IC	02
△ IC4	XE436A00	IC	NJM79M05FA		IC	03
△ IC5	XY455A00	IC	PQ1CG21H2F SW		電源IC SIL	04
△ IC6	X3121A00	IC	MD1422N DC/DC		電源IC	05
△ IC10	XY455A00	IC	PQ1CG21H2F SW		電源IC SIL	04
△* IC25	XH526A00	IC	PQ12RF1		アンプIC	03
IC361	XS377A00	IC	BA15218F OP AMP		アンプIC	01
IC362	XU965A00	IC	uPC29M33T-E1 3.3V		電源IC	03
IC363	XZ003A00	IC	PQ025EZ5MZP 2.5V		電源IC QFP	03
* JK351	WB071300	JACK. MNI	LGS6516-0100		ミニジャック	03
△ Q1	VG805300	TR	2SA1674 R, S		トランジスタ	01
△ Q2	VV655700	TR. DGT	DTC144EKA		デジタルトランジスタ	01

* New Parts (新規部品)

Note) Those parts marked with "#" are not included in the P.C.B. ass'y. (マーク#の部品は、基板に含まれません)

DVR-S200 P.C.B. SUB

Ref. No.	PART NO.	Description	Remarks	Markets	部品名	Rank
△ Q3	VR510800	TR	2SD2396 J, K		トランジスタ	01
Q4	VV556400	TR	2SC2412K Q, R, S		トランジスタ	01
Q361	VV655000	TR. DGT	DTA114EKA		デジタルトランジスタ	01
Q362	VV655000	TR. DGT	DTA114EKA		デジタルトランジスタ	01
Q363	VZ725900	TR	2SD1938F S, T		トランジスタ	
Q364	VZ725900	TR	2SD1938F S, T		トランジスタ	
Q365	VV655400	TR. DGT	DTC114EKA		デジタルトランジスタ	01
Q366	VV655400	TR. DGT	DTC114EKA		デジタルトランジスタ	01
R20	HV753220	R. CAR. FP	2. 2Ω 1/4W		不燃化カーボン抵抗	01
△ R22	VP941000	R. MTL. OXD	680Ω 1W		酸化金属被膜抵抗	01
R29	HV756220	R. CAR. FP	2. 2KΩ 1/4W		不燃化カーボン抵抗	01
△ R31	VP940600	R. MTL. OXD	220Ω 1W		酸化金属被膜抵抗	01
△ R38	VP941000	R. MTL. OXD	680Ω 1W		酸化金属被膜抵抗	01
R374	HV755100	R. CAR. FP	100Ω 1/4W		不燃化カーボン抵抗	01
R375	HV755100	R. CAR. FP	100Ω 1/4W		不燃化カーボン抵抗	01
R376	HV755100	R. CAR. FP	100Ω 1/4W		不燃化カーボン抵抗	01
R377	HV755100	R. CAR. FP	100Ω 1/4W		不燃化カーボン抵抗	01
△ RY1	V6017400	RELAY	DC SDT-S-112LMR2		リレー 12V	04
SW331	WA876500	SW. RT. ENC	EVEGC3F2024B		ロータリーエンコーダ	
SW332	VV020300	SW. TACT	SKQNAA		タクトSW	01
SW333	VV020300	SW. TACT	SKQNAA		タクトSW	01
SW334	VV020300	SW. TACT	SKQNAA		タクトSW	01
SW335	VV020300	SW. TACT	SKQNAA		タクトSW	01
SW336	VV020300	SW. TACT	SKQNAA		タクトSW	01
SW337	VV020300	SW. TACT	SKQNAA		タクトSW	01
SW338	VV020300	SW. TACT	SKQNAA		タクトSW	01
SW339	VV020300	SW. TACT	SKQNAA		タクトSW	01
SW340	VV020300	SW. TACT	SKQNAA		タクトSW	01
SW341	VV020300	SW. TACT	SKQNAA		タクトSW	01
△ T1	X2490A00	TRANS. PWR		J	サブトランス	05
△* T1	X2491A00	TRANS. PWR		UC	サブトランス	
△* T1	X2493A00	TRANS. PWR		A	サブトランス	
△* T1	X2494A00	TRANS. PWR		BG	サブトランス	
△* T1	X2948A00	TRANS. PWR		KL	サブトランス	
△* T1	X4434A00	TRANS		R	サブトランス	
* U351	WB437900	L. DTCT	GP1UD281YK		リモコン受光ユニット	
	EP600530	SCR. BND. HD	3x8 MFZ2BL		バインドSタイトネジ	01

* New Parts (新規部品)

98 Note) Those parts marked with “#” are not included in the P.C.B. ass'y. (マーク#の部品は、基板に含まれません)

DVR-S200 P.C.B. FL

Ref. No.	PART NO.	Description	Remarks	Markets	部品名	Rank
*	WC002800	P. C. B.	FL		P C B F L	
CB941	V7667200	CN. BS. PIN	20P TE		F F Cコネクター	
* CB943	VC166500	CN. BS. PIN	12P		コネクタベースポスト	01
CB944	VM688900	CN. BS. PIN	10P		F F Cコネクター	01
CB945	VB390300	CN. BS. PIN	7P		ベースピン	01
C942	UR818100	C. EL	100uF 6.3V		ケミコン	01
C943	UM388100	C. EL	100uF 10V		ケミコン	01
C948	VR357400	C. EL	4700uF 5.5V		バックアップケミコン	02
C949	UR819100	C. EL	1000uF 6.3V		ケミコン	01
C950	UM407100	C. EL	10uF 50V		ケミコン	01
C952	UM416220	C. EL	2.2uF 50V		ケミコン	01
C957	UR848100	C. EL	100uF 25V		ケミコン	01
C959	VR168300	C. MYLAR. ML	ECQ-V1H104JL3		積層マイラーコン	01
C960	UM407220	C. EL	22uF 25V		ケミコン	01
C961	UM406470	C. EL	4.7uF 50V		ケミコン	01
C962	UR839100	C. EL	1000uF 16V		ケミコン	01
C966	UA654100	C. MYLAR	0.01uF 50V		マイラーコン	01
C968	UM416100	C. EL	1uF 50V		ケミコン	01
D941	VV833200	D1ODE	1SS380		ダイオード	01
D942	VV833200	D1ODE	1SS380		ダイオード	01
D943	VU993500	D1ODE. ZENR	MA8062-H 6.4V		ツェナーダイオード	01
△ D949	VR253700	D1ODE. BRG	S1NB20 1A 200V		D Iブリッジ X 4	02
△ D950	VV307700	D1ODE	1N4002S		ダイオード	01
△ D951	VV307700	D1ODE	1N4002S		ダイオード	01
D952	VT332900	D1ODE	1SS355		ダイオード	01
D953	VT332900	D1ODE	1SS355		ダイオード	01
D954	VU993400	D1ODE. ZENR	MA8062-M 6.2V		ツェナーダイオード	01
D955	VU992600	D1ODE. ZENR	MA8051-M 5.1V		ツェナーダイオード	01
IC941	XV160A00	IC	LC75712E FLD		ロジックIC フラット	07
Q941	VV556400	TR	2SC2412K Q, R, S		トランジスタ	01
Q942	VV556400	TR	2SC2412K Q, R, S		トランジスタ	01
Q943	VV556400	TR	2SC2412K Q, R, S		トランジスタ	01
Q944	VV556400	TR	2SC2412K Q, R, S		トランジスタ	01
Q945	VV556400	TR	2SC2412K Q, R, S		トランジスタ	01
Q946	VV556400	TR	2SC2412K Q, R, S		トランジスタ	01
Q947	VP872700	TR	2SC4488 S, T		トランジスタ	01
Q948	iC174020	TR	2SC1740S R, S		トランジスタ	01
Q949	VV655700	TR. DGT	DTC144EKA		デジタルトランジスタ	01
Q950	VV556500	TR	2SA1037K Q, R, S		トランジスタ	01
Q951	VV556400	TR	2SC2412K Q, R, S		トランジスタ	01
R932	HV753220	R. CAR. FP	2.2Ω 1/4W		不燃化カーボン抵抗	01
R991	HV754680	R. CAR. FP	68Ω 1/4W		不燃化カーボン抵抗	01
R998	HV755100	R. CAR. FP	100Ω 1/4W		不燃化カーボン抵抗	01
R999	HV755100	R. CAR. FP	100Ω 1/4W		不燃化カーボン抵抗	01
V941	WB452200	FL. DSPLY	14-BT-80GNKF		蛍光表示管	
	WB552400	SHEET			シート/F L	

* New Parts (新規部品)

(Note) Those parts marked with "#" are not included in the P.C.B. ass'y. (マーク#の部品は、基板に含まれません)

CHIP CAPACITORS

Ref. No.	PART NO.	Description	Remarks	Markets	部品名	Rank
*	UF028100	C. EL. CHP 100uF 10V			チップケミコン	01
	UF037100	C. EL. CHP 10uF 16V			チップケミコン	01
	UF037470	C. EL. CHP 47uF 16V			チップケミコン	01
	UF066100	C. EL. CHP 1uF 50V			チップケミコン	01
	UF066220	C. EL. CHP 2. 2uF 50V			チップケミコン	01
	US034470	C. CE. M. CHP 0. 047uF 16V			チップセラコン	01
	US035100	C. CE. M. CHP 0. 1uF 16V			チップセラコン	01
	US044220	C. CE. M. CHP 0. 022uF 25V			チップセラコン	01
	US061100	C. CE. M. CHP 10pF 50V			チップセラコン	01
	US061180	C. CE. CHP 18pF 50V			チップセラコン	01
	US061220	C. CE. M. CHP 22pF 50V			チップセラコン	01
	US061270	C. CE. M. CHP 27pF 50V			チップセラコン	01
	US061330	C. CE. M. CHP 33pF 50V			チップセラコン	01
	US061470	C. CE. M. CHP 47pF 50V			チップセラコン	01
	US062100	C. CE. M. CHP 100pF 50V			チップセラコン	01
	US062150	C. CE. CHP 150pF 50V			チップセラコン	01
	US062220	C. CE. CHP 220pF 50V			チップセラコン	01
	US062330	C. CE. M. CHP 330pF 50V			チップセラコン	01
	US062470	C. CE. M. CHP 470pF 50V			チップセラコン	01
	US062680	C. CE. M. CHP 680pF 50V			チップセラコン	01
	US063100	C. CE. M. CHP 1000pF 50V			チップセラコン	01
	US063220	C. CE. M. CHP 2200pF 50V			チップセラコン	01
	US063470	C. CE. CHP 4700pF 50V			チップセラコン	01
	US064100	C. CE. M. CHP 0. 01uF 50V			チップセラコン	01
	US126100	C. CE. CHP 1uF 10V			チップセラ F	01
	US135100	C. CE. CHP 0. 1uF 16V			チップセラコン	01
	US135330	C. CE. CHP 0. 33uF 16V			チップセラ (F)	01
	US145100	C. CE. CHP 0. 1uF 25V			チップセラ (F)	01

* New Parts (新規部品)

Note) Those parts marked with “#” are not included in the P.C.B. ass'y. (マーク#の部品は、基板に含まれません)

CHIP RESISTORS

Ref. No.	PART NO.	Description	Remarks	Markets	部品名	Rank
	RD350000	R. CHP 0Ω 1/16W			チップ抵抗	01
	RD353100	R. CHP 1Ω 1/16W			チップ抵抗	01
	RD353220	R. CHP 2.2Ω 1/16W			チップ抵抗	01
	RD353470	R. CHP 4.7Ω 1/16W			チップ抵抗	01
	RD354100	R. CHP 10Ω 1/16W			チップ抵抗	01
	RD354330	R. CHP 33Ω 1/16W			チップ抵抗	01
	RD354470	R. CHP 47Ω 1/16W			チップ抵抗	01
	RD354750	R. CHP 75Ω 1/16W			チップ抵抗	01
	RD355100	R. CHP 100Ω 1/16W			チップ抵抗	01
	RD355220	R. CHP 220Ω 1/16W			チップ抵抗	01
	RD355330	R. CHP 330Ω 1/16W			チップ抵抗	01
	RD355470	R. CHP 470Ω 1/16W			チップ抵抗	01
	RD355820	R. CHP 820Ω 1/16W			チップ抵抗	01
	RD356100	R. CHP 1KΩ 1/16W			チップ抵抗	01
	RD356120	R. CHP 1.2KΩ 1/16W			チップ抵抗	01
	RD356150	R. CHP 1.5KΩ 1/16W			チップ抵抗	01
	RD356160	R. CHP 1.6KΩ 1/16W			チップ抵抗	01
	RD356180	R. CHP 1.8KΩ 1/16W			チップ抵抗	01
	RD356200	R. CHP 2KΩ 1/16W			チップ抵抗	01
	RD356220	R. CHP 2.2KΩ 1/16W			チップ抵抗	01
	RD356270	R. CHP 2.7KΩ 1/16W			チップ抵抗	01
	RD356330	R. CHP 3.3KΩ 1/16W			チップ抵抗	01
	RD356360	R. CHP 3.6KΩ 1/16W			チップ抵抗	01
	RD356390	R. CHP 3.9KΩ 1/16W			チップ抵抗	01
	RD356470	R. CHP 4.7KΩ 1/16W			チップ抵抗	01
	RD356510	R. CHP 5.1KΩ 1/16W			チップ抵抗	01
	RD356560	R. CHP 5.6KΩ 1/16W			チップ抵抗	01
	RD356680	R. CHP 6.8KΩ 1/16W			チップ抵抗	01
	RD356820	R. CHP 8.2KΩ 1/16W			チップ抵抗	01
	RD356910	R. CHP 9.1KΩ 1/16W			チップ抵抗	01
	RD357100	R. CHP 10KΩ 1/16W			チップ抵抗	01
	RD357110	R. CHP 11KΩ 1/16W			チップ抵抗	01
	RD357120	R. CHP 12KΩ 1/16W			チップ抵抗	01
	RD357130	R. CHP 13KΩ 1/16W			チップ抵抗	01
	RD357150	R. CHP 15KΩ 1/16W			チップ抵抗	01
	RD357160	R. CHP 16KΩ 1/16W			チップ抵抗	01
	RD357180	R. CHP 18KΩ 1/16W			チップ抵抗	01
	RD357220	R. CHP 22KΩ 1/16W			チップ抵抗	01
	RD357240	R. CHP 24KΩ 1/16W			チップ抵抗	01
	RD357270	R. CHP 27KΩ 1/16W			チップ抵抗	01
	RD357330	R. CHP 33KΩ 1/16W			チップ抵抗	01
	RD357390	R. CHP 39KΩ 1/16W			チップ抵抗	01
	RD357470	R. CHP 47KΩ 1/16W			チップ抵抗	01
	RD357680	R. CHP 68KΩ 1/16W			チップ抵抗	01
	RD357820	R. CHP 82KΩ 1/16W			チップ抵抗	01
	RD357910	R. CHP 91KΩ 1/16W			チップ抵抗	01
	RD358100	R. CHP 100KΩ 1/16W			チップ抵抗	01
	RD358220	R. CHP 220KΩ 1/16W			チップ抵抗	01
	RD358470	R. CHP 470KΩ 1/16W			チップ抵抗	01
	RD359100	R. CHP 1MΩ 1/16W			チップ抵抗	01
	RF456470	R. CHP 4.7KΩ 1/16W			チップ抵抗	
	RF456820	R. CHP 8.2KΩ 1/16W			チップ抵抗	
	RF457100	R. CHP 10KΩ 1/16W			チップ抵抗	
	RF457180	R. CHP 18KΩ 1/16W			チップ抵抗	

* New Parts (新規部品)

(Note) Those parts marked with "#" are not included in the P.C.B. ass'y. (マーク#の部品は、基板に含まれません)

NX-SW200 MAIN P.C.B.

Ref. No.	PART NO.	Description	Remarks	Markets	部品名	Rank
*	WB910900	P. C. B.	MAIN	JUCR	P C B M A I N	
*	WB911000	P. C. B.	MAIN	KABGL	P C B M A I N	
CB1	VB389900	CN. BS. PIN	3P		ベースピン	01
CB3	VB390100	CN. BS. PIN	5P		ベースピン	01
CB7	VP206500	HOLDER. FUS	EYF-52BCT		ヒューズホルダー	01
CB8	VP206500	HOLDER. FUS	EYF-52BCT		ヒューズホルダー	01
C1	UA655100	C. MYLAR	0. 1uF 50V		マイラーコン	01
C2	UA655820	C. MYLAR	0. 82uF 50V		マイラーコン	01
C3	FG644100	C. CE	0. 01uF 50V		セラコン	01
C4	UR867100	C. EL	10uF 50V		ケミコン	01
C5	UA654220	C. MYLAR	0. 022uF 50V		マイラーコン	01
C6	UR867100	C. EL	10uF 50V		ケミコン	01
C7	UA655330	C. MYLAR	0. 33uF 50V		マイラーコン	01
C8	UA655150	C. MYLAR	0. 15uF 50V		マイラーコン	01
C9	UA654100	C. MYLAR	0. 01uF 50V		マイラーコン	01
C10	UR877100	C. EL	10uF 63V		ケミコン	01
C11	UR877100	C. EL	10uF 63V		ケミコン	01
C12	UR867470	C. EL	47uF 50V		ケミコン	01
C13	UA655100	C. MYLAR	0. 1uF 50V		マイラーコン	01
C14	UR868100	C. EL	100uF 50V		ケミコン	01
C15	UR838100	C. EL	100uF 16V		ケミコン	01
C16	UR867100	C. EL	10uF 50V		ケミコン	01
C17	UA655180	C. MYLAR	0. 18uF 50V		マイラーコン	01
C18	UA654680	C. MYLAR	0. 068uF 50V		マイラーコン	02
C19	FG652100	C. CE	100pF 50V		セラコン	01
C20	UR837470	C. EL	47uF 16V		ケミコン	01
C21	UR837470	C. EL	47uF 16V		ケミコン	01
C22	UR867220	C. EL	22uF 50V		ケミコン	01
C23	UR865470	C. EL	0. 47uF 50V		ケミコン	01
C24	UR828220	C. EL	220uF 10V		ケミコン	01
C25	WB540200	C. POL. MTL	0. 1uF ECQE2104KF3		メタライズドポリコン	
C26	WB540200	C. POL. MTL	0. 1uF ECQE2104KF3		メタライズドポリコン	
C27	UA655180	C. MYLAR	0. 18uF 50V		マイラーコン	01
C28	UR867100	C. EL	10uF 50V		ケミコン	01
C29	UR867220	C. EL	22uF 50V		ケミコン	01
C30	UR867220	C. EL	22uF 50V		ケミコン	01
C31	UR867220	C. EL	22uF 50V		ケミコン	01
C32	UR867220	C. EL	22uF 50V		ケミコン	01
C33	UA655100	C. MYLAR	0. 1uF 50V		マイラーコン	01
C34	FG644100	C. CE	0. 01uF 50V		セラコン	01
△	C35	V6185300	C. CE. SAFTY	0. 01uF 275V	規格認定コン	
C37	UA655470	C. MYLAR	0. 47uF 50V		マイラーコン	01
C38	UA653220	C. MYLAR	2200pF 50V		マイラーコン	01
C41	UR867100	C. EL	10uF 50V		ケミコン	01
C57	UR868100	C. EL	100uF 50V		ケミコン	01
C58	V7093400	C. EL	6800uF 63V		ケミコン	
C59	V7093400	C. EL	6800uF 63V		ケミコン	
C72	UR867100	C. EL	10uF 50V		ケミコン	01
△	D1	VN011300	DIODE. BRG	D3SBA20 4A 200V	ダイオード	03
D2	VG440900	DIODE. ZENR	MTZJ15C 15V		ツェナーダイオード	01
D3	VG440900	DIODE. ZENR	MTZJ15C 15V		ツェナーダイオード	01
D4	VD631600	DIODE	1SS133, 176		ダイオード	01
D5	VD631600	DIODE	1SS133, 176		ダイオード	01

* New Parts (新規部品)

NX-SW200 P.C.B. MAIN

Ref. No.	PART NO.	Description	Remarks	Markets	部品名	Rank
D6	VD631600	D100E ZENR			ダイオード	01
D7	VG442500	D100E	MITJ24B 24V		ツエナーダイオード	01
D9	VU264100	D100E	1SR139-400		ダイオード	01
D10	VD631600	D100E	1SS133,176		ダイオード	01
D11	VU264100	D100E	1SR139-400		ダイオード	01
D19	VD631600	D100E	1SS133,176		ダイオード	01
D20	VD631600	D100E	1SS133,176		ダイオード	01
D21	VD631600	D100E	1SS133,176		ダイオード	01
D22	VD631600	D100E	1SS133,176		ダイオード	01
D23	VD631600	D100E	1SS133,176		ダイオード	01
D24	VU264100	D100E	1SR139-400		ダイオード	01
D25	VU264100	D100E	1SR139-400		ダイオード	01
F1	VS822500	FUSE	2A 125V		ヒューズ	02
F1	KB001770	FUSE	T1.0A 250V	JUCR		
F1	V7235100	CN,GND	JG-11-T	KABCL		
IC1	X3830A00	IC	STK404-120 120W		アンプ I C S I P	02
IC2	XB247A00	IC	uPC4570HA		I C	02
IC3	X3869A00	IC	TA7317P		I C	04
IC4	XB247A00	IC	uPC4570HA		I C	02
IC5	XB247A00	IC	uPC4570HA		I C	02
JK1	VJ726800	JACK,MNI			モノラルミニジャック	01
PJ1	VL552600	JACK,PIN	1P		ピンジャック	01
PJ1	WB543700	PIN	WB54370 L=70 #18		スタドルピン	01
Q1	IC224030	TR	2SC2240 GR, BL		トランジスタ	01
Q2	IA097030	TR	2S4970 GR, BL		トランジスタ	01
Q3	IC224030	TR	2SC2240 GR, BL		トランジスタ	01
Q4	IA097030	TR	2S4970 GR, BL		トランジスタ	01
Q5	IC181510	TR	2SC1815 Y		トランジスタ	01
Q6	IA101510	TR	2SA1015 Y		トランジスタ	01
Q7	IC181510	TR	2SC1815 Y		トランジスタ	01
Q8	IA101510	TR	2SA1015 Y		トランジスタ	01
Q9	V6896700	TR	2SD2531		トランジスタ	03
Q10	V6896500	TR	2SB1642		トランジスタ	04
Q16	V3028000	FET	2SK304 E		F E T	01
R1	HV756390	R.CAR.FP	3.9KΩ		不燃化カーボン抵抗	01
R5	HV756120	R.CAR.FP	1.2KΩ		不燃化カーボン抵抗	01
R27	HB027100	R.MTL.FLM	10KΩ		金属被膜抵抗	01
R28	V6022600	R.WW	0.1Ω		メタリット抵抗	01
R30	HV756100	R.CAR.FP	1KΩ		不燃化カーボン抵抗	01
R31	HB027200	R.MTL.FLM	20KΩ		金属被膜抵抗	01
R32	HV755100	R.CAR.FP	100Ω		不燃化カーボン抵抗	01
R35	HB027100	R.MTL.FLM	10KΩ		金属被膜抵抗	01
R36	HB027100	R.MTL.FLM	10KΩ		金属被膜抵抗	01
R39	VCT61400	R.MTL.OXD	1KΩ		酸化金属被膜抵抗	01
R45	HV755390	R.CAR.FP	390Ω		不燃化カーボン抵抗	01
R46	HV755390	R.CAR.FP	390Ω		不燃化カーボン抵抗	01
R47	VZ092500	R.MTL.OXD	0.22Ω		金属被膜抵抗	01
R48	HV754100	R.CAR.FP	10Ω		不燃化カーボン抵抗	01
R66	HB026270	R.MTL.FLM	2.7KΩ		金属被膜抵抗	01
R67	HB028100	R.MTL.FLM	100KΩ		金属被膜抵抗	01
R95	HV755100	R.CAR.FP	100Ω		不燃化カーボン抵抗	01
R96	VZ092500	R.MTL.OXD	0.22Ω		酸化金属被膜抵抗	01
R121	HV755390	R.CAR.FP	390Ω		不燃化カーボン抵抗	01

* New Parts (新機部品)

Note) Those parts marked with "*" are not included in the P.C.B. ass'y. (マウスの部品は、基板に含まれません)

NX-SW200 P.C.B. MAIN

Ref. No.	PART NO.	Description	Remarks	Markets	部品名	Rank
R123	HV756100	R.CAR.FP	1KΩ		不燃化カーボン抵抗	01
R265	HV755390	R.CAR.FP	390Ω		不燃化カーボン抵抗	01
RX1	VU161600	RELAY	DC 05A-SS-224DM3		リレー 24V	05
RX2	V2712300	RELAY	DC SDT-S-112LMR		リレー 12V	05
ST1	V4040500	SCR.TERM	M3		スクリヤー/ターミナル	01
ST2	V4040500	SCR.TERM	M3		スクリヤー/ターミナル	01
ST3	V4040500	SCR.TERM	M3		スクリヤー/ターミナル	01
TE1	V7658100	TERMI.WRAP	352-TX119		ラッピン端子	01
TE2	V7658100	TERMI.WRAP	352-TX119		ラッピン端子	01
	V5995800	PLATE,GND			ラッピン端子	01

* New Parts (新機部品)

Note) Those parts marked with "*" are not included in the P.C.B. ass'y. (マウスの部品は、基板に含まれません)

■ DVR-S200 EXPLODED VIEW

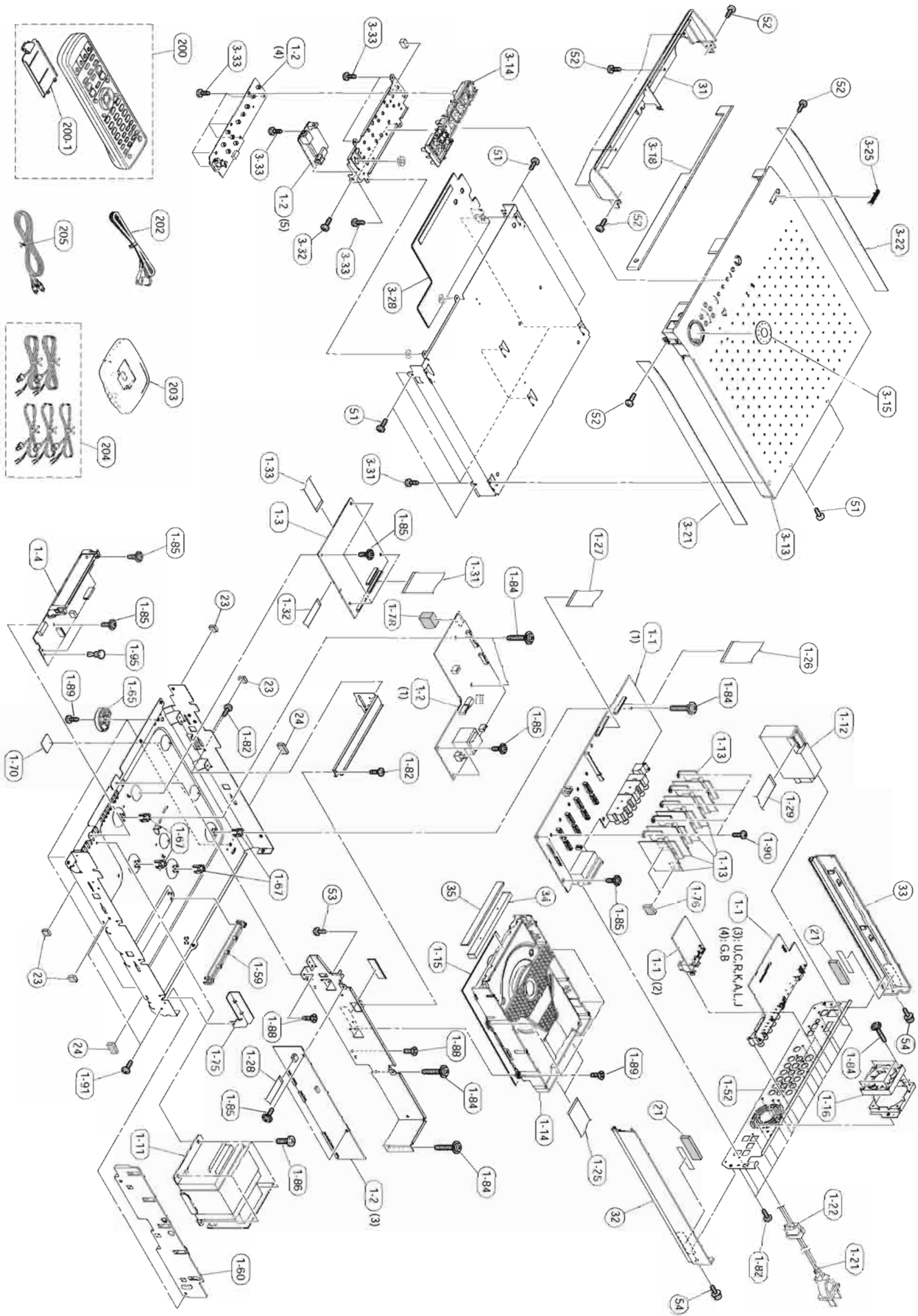

DVR-S200 MECHANICAL PARTS

Ref. No.	PART NO.	Description	Remarks	Markets	部品名	Rank
* 1-1	W601600	P.C.B. ASS'Y		J	P.C.B メイン	
* 1-1	W601700	P.C.B. ASS'Y		UKRKL	P.C.B メイン	
* 1-1	W601800	P.C.B. ASS'Y		BG	P.C.B メイン	
* 1-2	W601900	P.C.B. ASS'Y		J	P.C.B 集成 サブ	
* 1-2	W602000	P.C.B. ASS'Y		UC	P.C.B 集成 サブ	
* 1-2	W602100	P.C.B. ASS'Y		J	P.C.B 集成 サブ	
* 1-2	W602200	P.C.B. ASS'Y		R	P.C.B 集成 サブ	
* 1-2	W602300	P.C.B. ASS'Y		K	P.C.B 集成 サブ	
* 1-2	W602400	P.C.B. ASS'Y		A	P.C.B 集成 サブ	
* 1-2	W602500	P.C.B. ASS'Y		BG	P.C.B 集成 サブ	
* 1-2	W602600	P.C.B. ASS'Y		L	P.C.B 集成 サブ	
* 1-3	W602700	P.C.B. ASS'Y		J	P.C.B デジタル	
* 1-3	W602800	P.C.B. ASS'Y		UKRKL	P.C.B デジタル	
* 1-4	W602900	P.C.B. ASS'Y		J	P.C.B デジタル	
* 1-1	W603000	POWER TRANSFORMER		J	電源トランス	
* 1-1	W603100	POWER TRANSFORMER		UC	電源トランス	
* 1-1	W603200	POWER TRANSFORMER		R	電源トランス	
* 1-1	W603300	POWER TRANSFORMER		K	電源トランス	
* 1-1	W603400	POWER TRANSFORMER		A	電源トランス	
* 1-1	W603500	POWER TRANSFORMER		BG	電源トランス	
* 1-1	W603600	POWER TRANSFORMER		L	電源トランス	
* 1-2	W603700	AM/FM TUNER		J	AM/FM チューナー	
* 1-2	W603800	AM/FM TUNER		UKRKL	AM/FM チューナー	
* 1-2	W603900	AM/FM TUNER		BG	AM/FM チューナー	
* 1-3	W604000	D-AMP MODULE		A8G	D-アンプモジュール	
* 1-14	W604100	DVD MECHANISM			DVDメカニズム	
* 1-15	W604200	DVD MECHANISM			DVDメカニズム	
* 1-16	W604300	DC FAN MOTOR			モーター	
* 1-21	W604400	POWER CABLE		J	電源コード	
* 1-21	W604500	POWER CABLE		UC	電源コード	
* 1-21	W604600	POWER CABLE		K	電源コード	
* 1-21	W604700	POWER CABLE		R	電源コード	
* 1-21	W604800	POWER CABLE		A	電源コード	
* 1-21	W604900	POWER CABLE		B	電源コード	
* 1-21	W605000	POWER CABLE		GL	電源コード	
* 1-25	W605100	COND STRPPER			コードストッパー	
* 1-25	W605200	FLEXIBLE FLAT CABLE			電源コード	
* 1-26	W605300	FLEXIBLE FLAT CABLE			電源コード	
* 1-27	W605400	FLEXIBLE FLAT CABLE			電源コード	
* 1-28	W605500	FLEXIBLE FLAT CABLE			電源コード	
* 1-29	W605600	FLEXIBLE FLAT CABLE			電源コード	
* 1-31	W605700	FLEXIBLE FLAT CABLE			電源コード	
* 1-32	W605800	FLEXIBLE FLAT CABLE			電源コード	
* 1-33	W605900	FLEXIBLE FLAT CABLE			電源コード	
* 1-52	W606000	REAR PANEL		J	リアパネル	
* 1-52	W606100	REAR PANEL		UKRKL	リアパネル	
* 1-59	W606200	REAR PANEL		BG	リアパネル	
* 1-60	W606300	SLIPPERY/POWER-CODE			サボート/UCD	
* 1-67	W606400	LEG ASS'Y			サボート/UCD	
* 1-70	W606500	SHEET/SCREEN-MASK			スクリーン/シート	
* 1-73	W606600	SHEET/SCREEN-MASK			スクリーン/シート	
* 1-75	W606700	SHEET/SHIELD-UCD			スクリーン/シート	

Ref. No.	PART NO.	Description	Remarks	Markets	部品名	Rank
* 1-76	W606800	LEG		J	レッグ	
* 1-78	W606900	SPACER P.C.B-M		J	スペーサー-P.C.B-M	
* 1-82	W607000	BIND HEAD BONDING B-T. SCREW		J	ボンドヘッドボルトネジ	
* 1-84	W607100	PW HEAD B-TIGHT SCREW		BG	PWヘッドボルトネジ	
* 1-85	W607200	FLAT HEAD B-TIGHT SCREW		J	皿ヘッドボルトネジ	
* 1-86	W607300	BIND HEAD S-TIGHT SCREW		A8G	ヘッドボルトネジ	
* 1-88	W607400	FLAT HEAD S-TIGHT SCREW		J	皿ヘッドボルトネジ	
* 1-89	W607500	FLAT HEAD B-TIGHT SCREW		BG	皿ヘッドボルトネジ	
* 1-90	W607600	BIND HEAD P-TIGHT SCREW		J	ヘッドボルトネジ	
* 1-95	W607700	PUSH RIVET		J	押し留め	
* 3-13	W607800	TOP PANEL		UKRKL	トップパネル	
* 3-13	W607900	TOP PANEL		BG	トップパネル	
* 3-14	W608000	BUTTON/OPF			ボタンの押しボタン	
* 3-15	W608100	VOLUME Knob/035			ボリュームノブ	
* 3-18	W608200	WINDOW PANEL LID			ウインドウパネル	
* 3-21	W608300	SIDE/SHEET R			サイドシート R	
* 3-22	W608400	SIDE/SHEET L			サイドシート L	
* 3-25	W608500	EMBLEM			エンブレム	
* 3-28	W608600	SHEET/SHIELD TOP			シート/シールドトップ	
* 3-31	W608700	BIND HEAD P-TIGHT SCREW			ヘッドボルトネジ	
* 3-32	W608800	BIND HEAD BONDING B-T. SCREW			ボンドヘッドボルトネジ	
* 3-33	W608900	BIND HEAD P-TIGHT SCREW			ヘッドボルトネジ	
* 21	W609000	FRAME/SIDE			フレーム/サイド	
* 23	W609100	CUSHION/2			クッション/2	
* 24	W609200	DAMPER			ダンプ	
* 31	W609300	BOTTOM COVER			ボトムカバー	
* 32	W609400	SIDE COVER R			サイドカバー R	
* 33	W609500	SIDE COVER L			サイドカバー L	
* 34	W609600	LID HOLDER			リッドホルダー	
* 35	W609700	LID WINDOW			リッドウィンドウ	
* 51	W609800	BIND HEAD BONDING B-T. SCREW			ボンドヘッドボルトネジ	
* 52	W609900	BIND HEAD P-TIGHT SCREW			ヘッドボルトネジ	
* 53	W610000	BIND HEAD B-TIGHT SCREW			ヘッドボルトネジ	
* 54	W610100	BIND HEAD P-TIGHT SCREW			ヘッドボルトネジ	
* 200	W610200	ACCESSORIES			付属品	
* 200	W610300	REMOTE CONTROL			リモコン	
* 200	W610400	REMOTE CONTROL			リモコン	
* 200-1	W610500	BATTERY COVER			電池蓋	
* 202	W610600	INDOOR FM ANTENNA			F M 簡易アンテナ	
* 203	W610700	ANTENNA, AM LOOP			AMビルーアンテナ	
* 204	W610800	SPEAKER CABLE KIT			スピーカーケーブルキット	
* 205	W610900	VIDEO PIN CABLE BATTERY			ビデオ用ピンケーブル電池	

NX-P200 EXPLODED VIEW

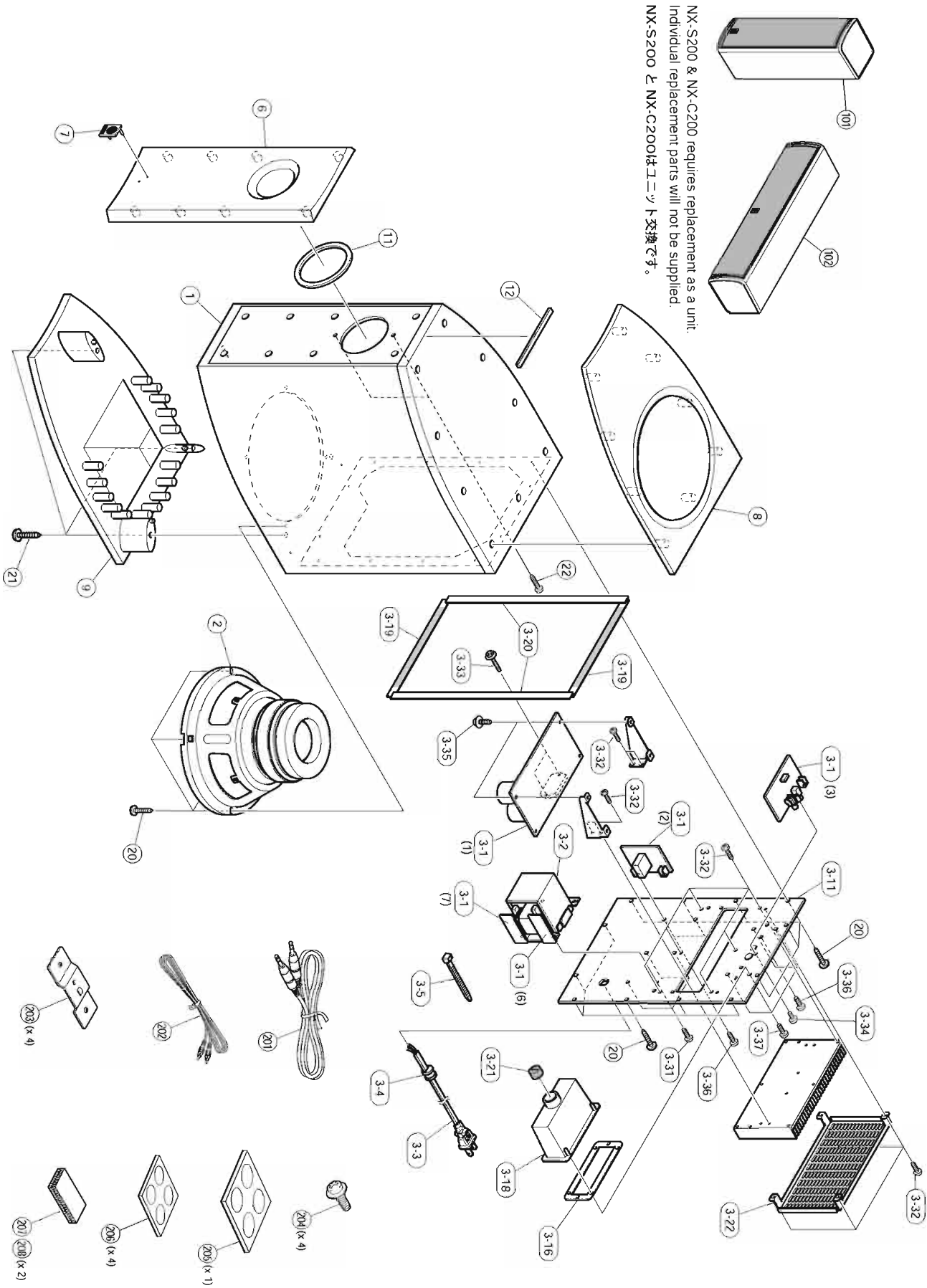

NX-S200 & NX-C200 requires replacement as a unit.
 Individual replacement parts will not be supplied.
 NX-S200 と NX-C200はユニット交換です。

■ NX-P200 MECHANICAL PARTS

Ref. No.	PART NO.	Description	Remarks	Markets	部品名	Rank
* 1	WB930700	CABINET ASS'Y		JUCR/CABL	キャビネット ASS'Y	
* 1	WK515000	CABINET ASS'Y		G	キャビネット ASS'Y	
* 2	YA939400	DRIVER, WOFFER		JUCR	スビーカーユニット	
* 3-1	WB910900	P.C.B. ASS'Y	JU2170	KABGL	P C B MAIN	
* 3-1	WB911000	P.C.B. ASS'Y		J	P C B MAIN	
△* 3-2	YA732400	POWER TRANSFORMER		J	電源トランス	
△* 3-2	YA733400	POWER TRANSFORMER		UC	電源トランス	
△* 3-2	YA734400	POWER TRANSFORMER		R	電源トランス	
△* 3-2	YA735400	POWER TRANSFORMER		K	電源トランス	
△* 3-2	YA736400	POWER TRANSFORMER		AL	電源トランス	
△* 3-2	YA737400	POWER TRANSFORMER		BG	電源トランス	
△* 3-3	V6893000	POWER CABLE		J	電源コード	
△* 3-3	VZ689600	POWER CABLE		UC	電源コード	
△* 3-3	WA507100	POWER CABLE		R	電源コード	
△* 3-3	WB012900	POWER CABLE		K	電源コード	
△* 3-3	V6792800	POWER CABLE		A	電源コード	
△* 3-3	V6797100	POWER CABLE		B	電源コード	
△* 3-3	V6893100	POWER CABLE		GL	電源コード	
3-4	CB072750	CORD STOPPER			コードストッパー	
3-5	CB069250	BINDING TIE	SR-4H-4		コードストッパー	
* 3-11	WB817200	REAR PANEL	BK-1	J	裏組止め	
* 3-11	WB817300	REAR PANEL		UC	リアパネル	
* 3-11	WB817400	REAR PANEL		BK	リアパネル	
* 3-11	WB817500	REAR PANEL		A	リアパネル	
* 3-11	WB817600	REAR PANEL		BG	リアパネル	
* 3-11	WB902700	REAR PANEL		L	リアパネル	
3-16	WB930900	PACKING			パッキン	
3-18	WB817100	COVER			カバー	
* 3-19	WB931500	PACKING			パッキン	
* 3-20	WB931600	PACKING			パッキン	
3-21	V5984900	BUSH, B			ワッシユ B	
* 3-22	WB852400	REAR COVER			リアカバー	
3-31	V6655200	BIND HEAD S-TIGHT SCREW	4x8		＋ハインツSタイト	
3-32	EP600190	BIND HEAD B-TIGHT SCREW	3x8		＋ハインツBタイトネジ	
3-33	WB909900	SCREW	SP 3x18		スクリユ・Tr	
3-34	EP630640	BIND HEAD P-TIGHT SCREW	3x10		＋ハインツPタイトネジ	
3-35	VT669300	PH HEAD B-TIGHT SCREW	3x8-8		PWヘッドBタイトネジ	
3-36	VC082800	BIND HEAD BONDING SCREW	3x6		ボツテインツ小ネジ	
3-37	VIA847600	BIND HEAD P-TIGHT SCREW	4x12		＋ハインツPタイトネジ	
* 6	WB816800	FRONT PANEL			フロントパネル	
7	V6307900	EMBLEM			エンブレム	
* 8	WB816900	TOP PANEL			トップパネル	
* 9	WB817000	BASE			ベース	
* 11	WB910200	PACKING			パッキン C	
* 12	WC330900	PACKING			パッキン F	
20	EP040070	BIND HEAD TAPPING SCREW	4x20		＋ハインツTPネジ	
* 22	VF573000	BIND HEAD TAPPING SCREW	4x25		＋ハインツTPネジ	
* 101	WB904600	SATELLITE SPEAKER UNIT	4x16		＋ハインツFPタイト	
* 101	WB904500	SATELLITE SPEAKER UNIT	NK-5200		サテライトSPユニット	
* 101	WB906500	SATELLITE SPEAKER UNIT	NK-5200		サテライトSPユニット	
* 102	WB906600	CENTER SPEAKER UNIT	NK-C200		センターSPユニット	
* 102	WB906700	CENTER SPEAKER UNIT	NK-C200		センターSPユニット	

*New Parts (新機部品)

Ref. No.	PART NO.	Description	Remarks	Markets	部品名	Rank
* 201	WB918300	ACCESSORIES			付属品	
* 202	WB918400	SYSTEM CONTROL CABLE			システム接続ケーブル	
* 203	WB993100	SUBWOOFER CABLE			サブウーハーケーブル	
* 204	V5046000	MOUNTING BRACKET	1P 5M BLACK 1pc		取付金具	
* 205	WC352300	BIND HEAD SCREW	4x10		＋ハインツ小ネジ	
* 206	WB931700	NON SKID PAD	M25 13 4pcs/set		滑止パッド	
* 207	V1923000	NON SKID PAD	M12 12 4pcs/set		滑止パッド	
* 208	V1923100	FASTENER	S1-3541		固定ネジ	
			S1-3542		固定ネジ	

*New Parts (新機部品)

REMOTE CONTROL

▼ J model

▼ U, C, R, A, K, L models

▼ B, G models

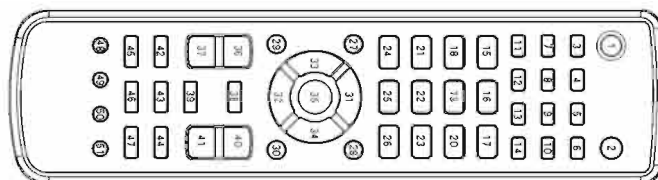
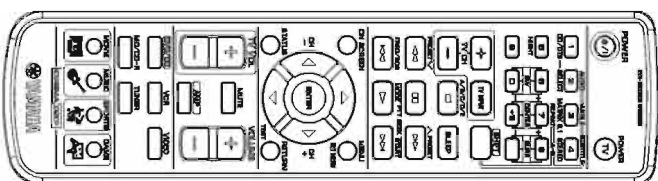
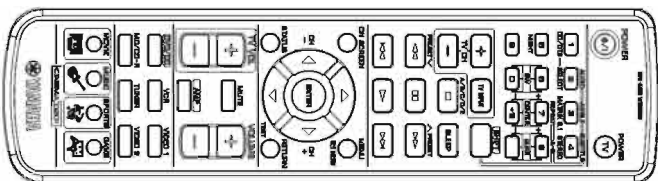
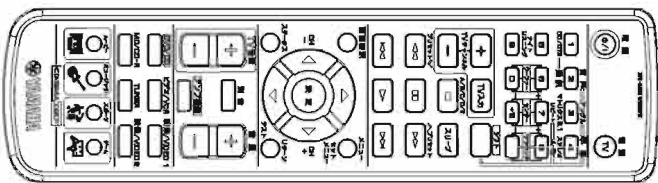

SCHEMATIC DIAGRAM

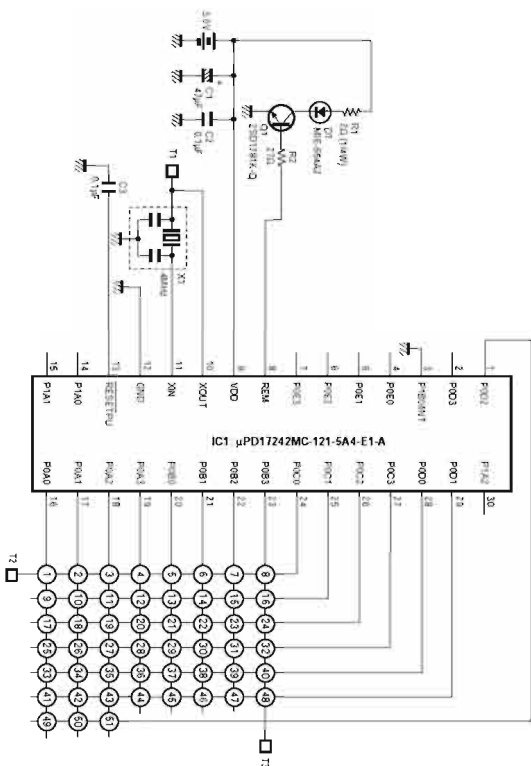

Key No.	Function	TUNER	DVD	SHIFT (DVD)	AMP	MD	CD-R
1	POWER	78-0F	78-0F	78-0F	78-0F	78-0F	78-0F
2	TV POWER	TV (Presel) Code Transmitt					
3	1	78-11	7C-94	-	78-99	79-85	7F-91
4	2	78-12	7C-95	7C-A0	78-9A	79-86	7F-92
5	3	78-13	7C-96	7C-AE	78-96	79-87	7F-93
6	4	78-14	7C-97	7C-AA	78-96	79-88	7F-94
7	5	78-15	7C-98	7C-E2	78-9A	79-89	7F-95
8	6	78-16	7C-99	7C-A1	78-9C	79-8A	7F-96
9	7	78-17	7C-9A	7C-A3	78-96	79-8A	7F-97
10	8	78-18	7C-9B	7C-A4	78-98	79-8C	7F-98
11	9	-	7C-9C	-	78-4D	79-8D	7F-99
12	0	-	7C-93	-	78-4D	79-8E	7F-90
13	*+10	-	-	-	78-87	79-8F	7F-9A
14	SURROUND	-	-	-	78-89	-	-
15	TV CH +	TV (Presel) Code Transmitt					
16	TV INPUT	TV (Presel) Code Transmitt					
17	SHIFT (CODE SET)	-	-	-	-	-	-
18	TV CH -	TV (Presel) Code Transmitt					
19	STOP	78-1D	7C-85	7C-85	-	79-AA	7F-84
20	SLEEP	78-4F	78-4F	78-4F	78-4F	78-4F	78-4F
21	SEARCH - (REW)	78-1C	7C-86	7C-86	-	79-AC	7F-88
22	PAUSE	-	7C-83	7C-83	-	79-AD	7F-83
23	SEARCH + (FF)	78-18	7C-87	7C-87	-	79-AD	7F-88
24	SKIP -	78-81	7C-89	7C-89	-	79-AB	7F-86
25	PLAY	78-82	7C-82	7C-82	-	79-AB	7F-82
26	SKIP +	78-83	7C-8A	7C-8A	-	79-AE	7F-87
27	ON SCREEN	-	7C-A6	7C-A6	-	-	-
28	MENU	-	7C-B2	7C-B2	78-9D	-	-
29	STATUS	-	7C-A7	7C-A7	-	-	-
30	RETURN	-	7C-B7	7C-B7	78-5F	-	-
31	UP	-	7C-B4	7C-B4	78-8E	-	-
32	DOWN	-	7C-B3	7C-B3	78-8F	-	-
33	LEFT	-	7C-B5	7C-B5	78-9F	-	-
34	RIGHT	-	7C-B6	7C-B6	78-9E	-	-
35	OK	-	7C-B8	7C-B8	-	-	-
36	TV VOLUME +	TV (Presel) Code Transmitt					
37	TV VOLUME -	TV (Presel) Code Transmitt					
38	MUTE	78-9C	78-9C	78-9C	78-9C	78-9C	78-9C
39	AMP	-	-	-	-	-	-
40	VOLUME UP	78-1E	78-1E	78-1E	78-1E	78-1E	78-1E
41	VOLUME DOWN	78-1F	78-1F	78-1F	78-1F	78-1F	78-1F
42	DVDCD	78-4A	78-4A	78-4A	78-4A	78-4A	78-4A
43	VCR	78-49	78-49	78-49	78-49	78-49	78-49
44	VIDEO1	78-DE	78-DE	78-DE	78-DE	78-DE	78-DE
45	MVDCDR	78-DD	78-DD	78-DD	78-DD	78-DD	78-DD
46	TUNER	78-4B	78-4B	78-4B	78-4B	78-4B	78-4B
47	VIDEO2	78-DE	78-DE	78-DE	78-DE	78-DE	78-DE
48	MOVIE	78-D9	78-D9	78-D9	78-D9	78-D9	78-D9
49	MUSIC	78-DA	78-DA	78-DA	78-DA	78-DA	78-DA
50	SPORTS	78-DB	78-DB	78-DB	78-DB	78-DB	78-DB
51	GAME	78-DC	78-DC	78-DC	78-DC	78-DC	78-DC