

AV RECEIVER/AV AMPLIFIER RX-V340/RX-V340RDS/ HTR-5630/HTR-5630RDS/DSP-AX340 SERVICE MANUAL

IMPORTANT NOTICE

This manual has been provided for the use of authorized YAMAHA Retailers and their service personnel. It has been assumed that basic service procedures inherent to the industry, and more specifically YAMAHA Products, are already known and understood by the users, and have therefore not been restated.

WARNING: Failure to follow appropriate service and safety procedures when servicing this product may result in personal injury, destruction of expensive components, and failure of the product to perform as specified. For these reasons, we advise all YAMAHA product owners that any service required should be performed by an authorized YAMAHA Retailer or the appointed service representative.

IMPORTANT: The presentation or sale of this manual to any individual or firm does not constitute authorization, certification or recognition of any applicable technical capabilities, or establish a principle-agent relationship of any form.

The data provided is believed to be accurate and applicable to the unit(s) indicated on the cover. The research, engineering, and service departments of YAMAHA are continually striving to improve YAMAHA products. Modifications are, therefore, inevitable and specifications are subject to change without notice or obligation to retrofit. Should any discrepancy appear to exist, please contact the distributor's Service Division.

WARNING: Static discharges can destroy expensive components. Discharge any static electricity your body may have accumulated by grounding yourself to the ground buss in the unit (heavy gauge black wires connect to this buss).

IMPORTANT: Turn the unit OFF during disassembly and part replacement. Recheck all work before you apply power to the unit.

■ CONTENTS

TO SERVICE PERSONNEL	2	CONFIRMATION OF IDLING CURRENT /	
FRONT PANELS	3~4	アイドリング電流の確認	36
REAR PANELS	4~7	DISPLAY DATA	37~38
REMOTE CONTROL PANELS	7	IC DATA	39~44
SPECIFICATIONS / 参考仕様	8~11	PRINTED CIRCUIT BOARD	45~53
INTERNAL VIEW	11	PIN CONNECTION DIAGRAM	54
DISASSEMBLY PROCEDURES / 分解手順	12~14	BLOCK DIAGRAM	55
SELF DIAGNOSIS FUNCTION (DIAG) /		SCHEMATIC DIAGRAM	56~60
自己診断機能 (ダイアグ)	15~35	PARTS LIST	61~79
		REMOTE CONTROL	80~81



このサービスマニュアルは、エコマーク認定の再生紙を使用しています。
This Service Manual uses recycled paper.

100848

Copyright 2003 YAMAHA CORPORATION □
This manual is copyrighted by YAMAHA and may not be copied or □
redistributed either in print or electronically without permission. □



YAMAHA
YAMAHA CORPORATION
P.O.Box 1, Hamamatsu, Japan

HTR-5630/HTR-5630RDS/DSP-AX340
RX-V340/RX-V340RDS/
HTR-5630/HTR-5630RDS/DSP-AX340

■ TO SERVICE PERSONNEL

1. Critical Components Information
Components having special characteristics are marked ⚠ and must be replaced with parts having specifications equal to those originally installed.
 2. Leakage Current Measurement (For 120V Models Only)
When service has been completed, it is imperative to verify that all exposed conductive surfaces are properly insulated from supply circuits.
- Meter impedance should be equivalent to 1500 ohm shunted by 0.15μF.

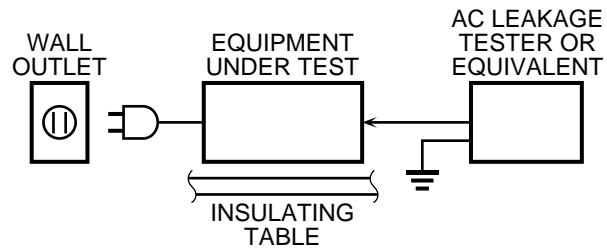

- Leakage current must not exceed 0.5mA.
- Be sure to test for leakage with the AC plug in both polarities.



“CAUTION”

“F681: FOR CONTINUED PROTECTION AGAINST RISK OF FIRE, REPLACE ONLY WITH SAME TYPE 5A, 125V FUSE.”

CAUTION

F681: REPLACE WITH SAME TYPE 5A, 125V FUSE.

ATTENTION

F681: UTILISER UN FUSIBLE DE RECHANGE DE MEME TYPE DE 5A, 125V.

WARNING: CHEMICAL CONTENT NOTICE!

The solder used in the production of this product contains LEAD. In addition, other electrical/electronic and/or plastic (where applicable) components may also contain traces of chemicals found by the California Health and Welfare Agency (and possibly other entities) to cause cancer and/or birth defects or other reproductive harm.

DO NOT PLACE SOLDER, ELECTRICAL/ELECTRONIC OR PLASTIC COMPONENTS IN YOUR MOUTH FOR ANY REASON WHATSOEVER!

Avoid prolonged, unprotected contact between solder and your skin! When soldering, do not inhale solder fumes or expose eyes to solder/flux vapor!

If you come in contact with solder or components located inside the enclosure of this product, wash your hands before handling food.

• DIMENSIONS / 寸法図

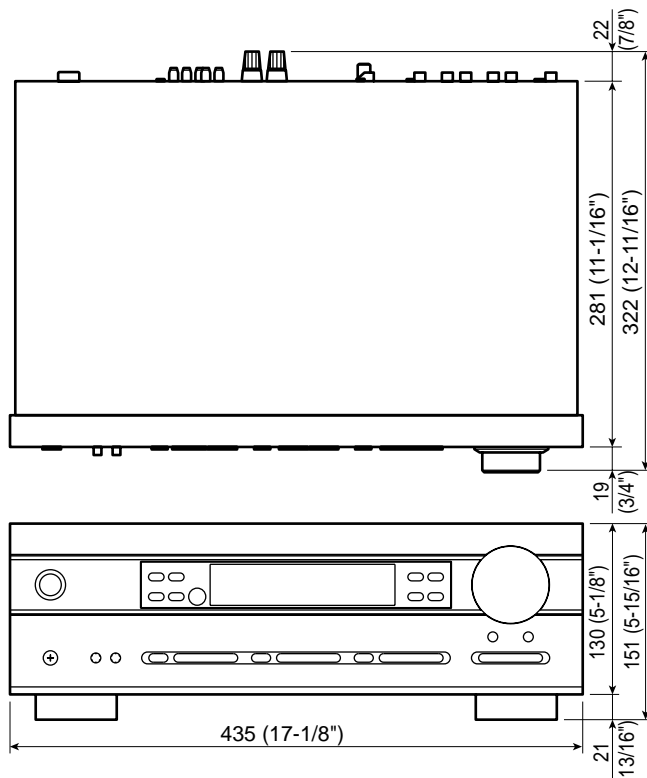

Unit : mm (inch)
単位: mm (インチ)

RX-V340/RX-V340RDS/
HTR-5630/HTR-5630RDS/DSP-AX340

FRONT PANELS

RX-V340 (C, L, R, T models)

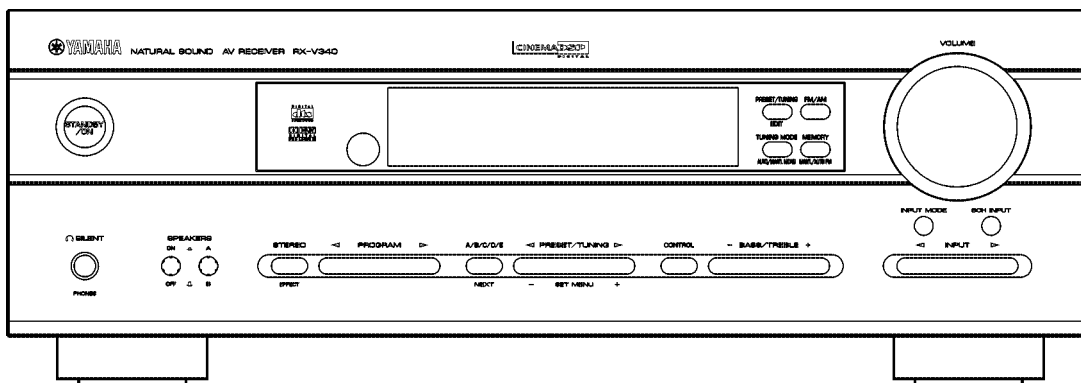

RX-V340RDS (B, G models)

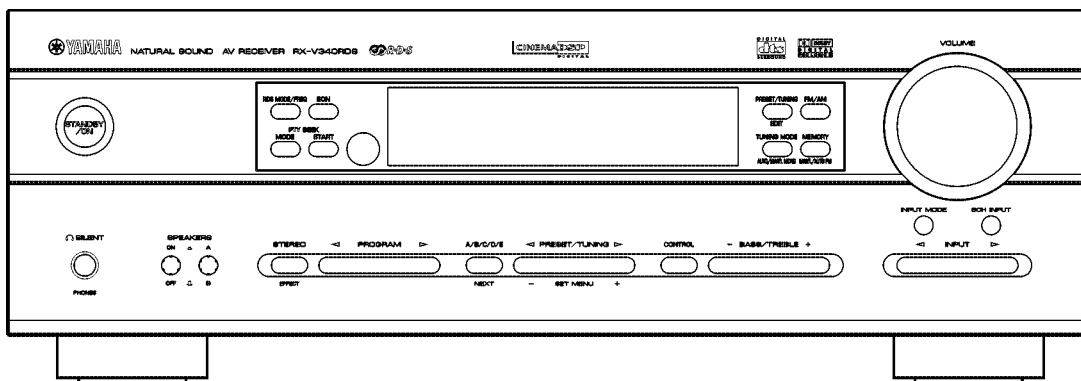

HTR-5630 (U, C, A, R, T, K models)

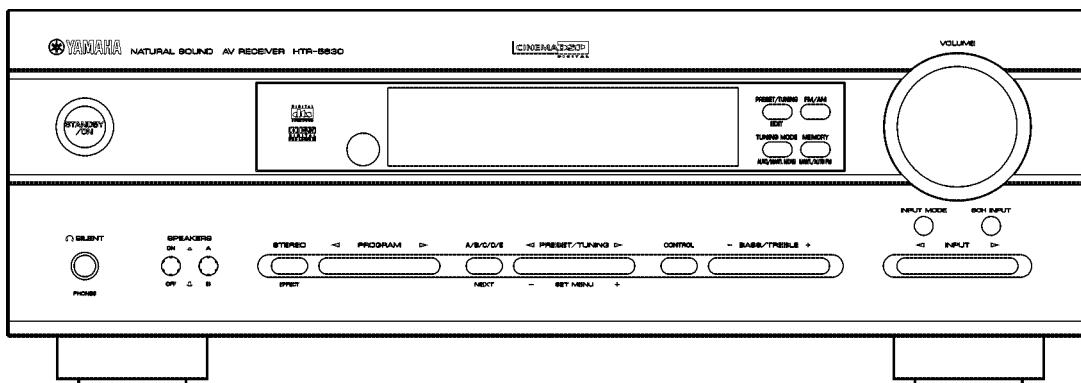

HTR-5630RDS (B, G models)

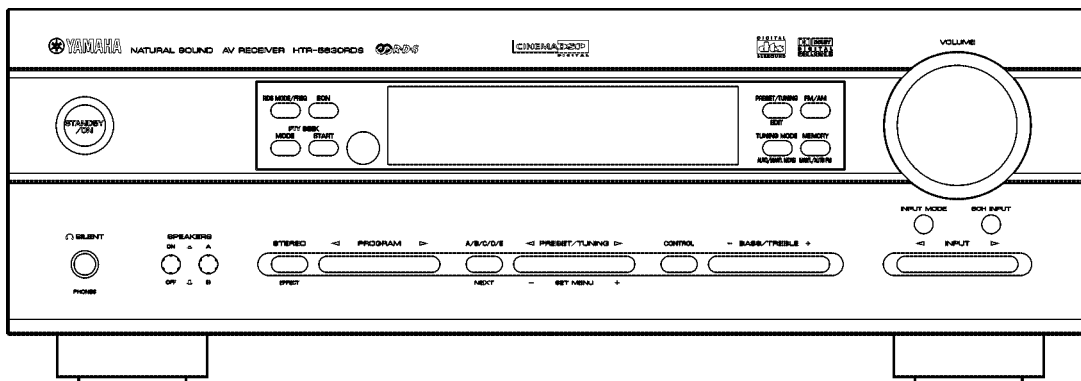

RX-V340/RX-V340RDS/
HTR-5630/HTR-5630RDS/DSP-AX340

RX-V340 (T model)

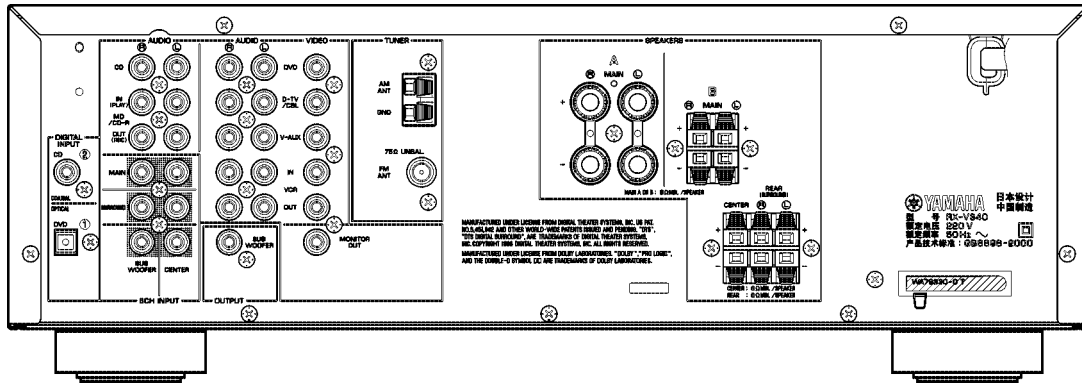

RX-V340RDS (B, G models)

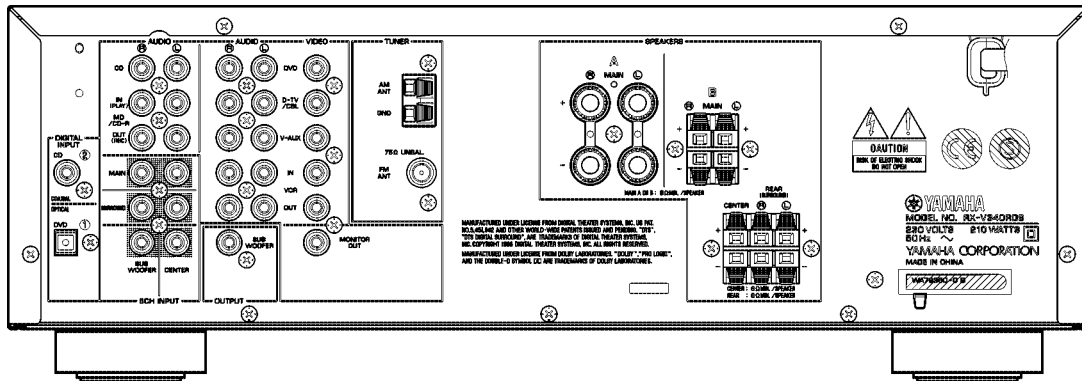

HTR-5630 (U, C models)

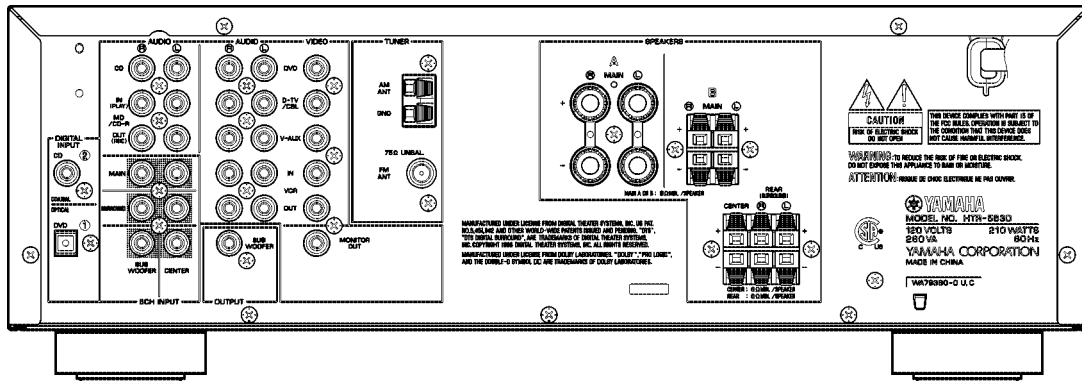

HTR-5630 (A model)

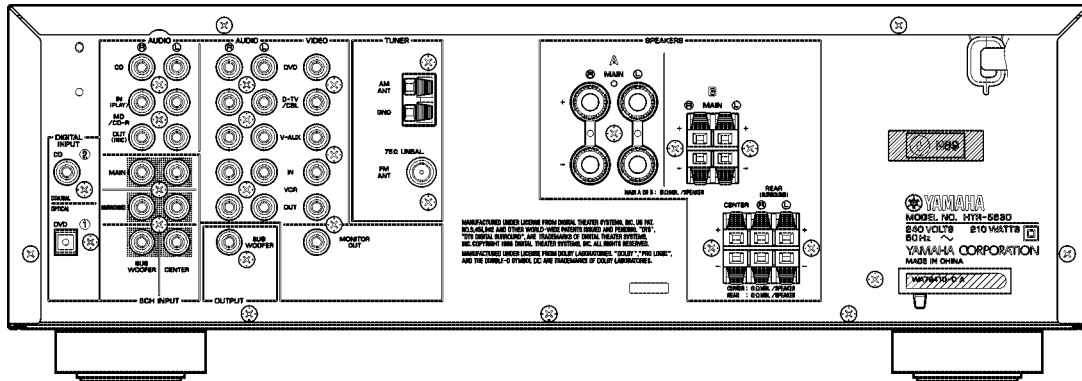

RX-V340/RX-V340RDS/HTR-5630/HTR-5630RDS/DSP-AX340

HTR-5630RDS (B, G model)

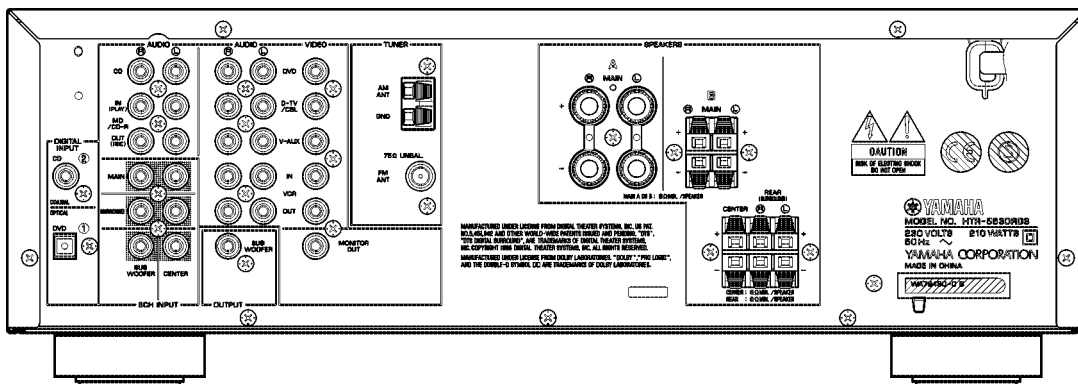

DSP-AX340 (J model)

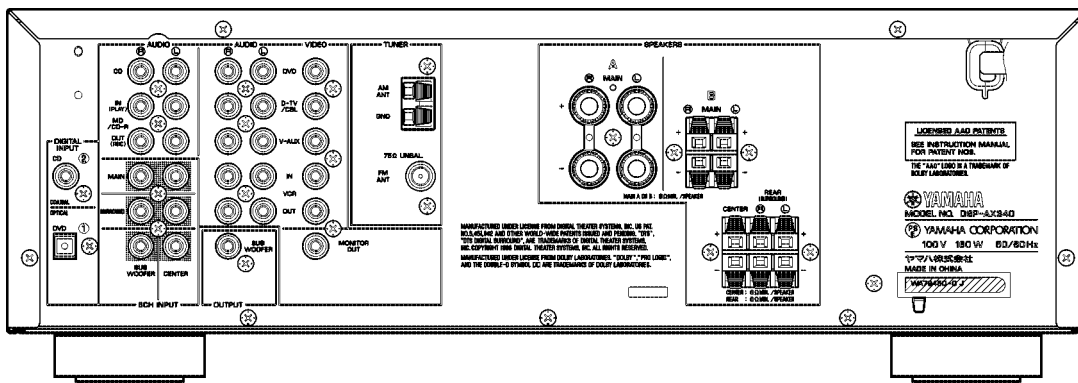

■ REMOTE CONTROL PANELS

RX-V340 (C, L, R, T models)
 HTR-5630 (U, C, A, L, R, T, K models)
 DSP-AX340 (J model)

RX-V340RDS (B, G models)
 HTR-5630RDS (B, G models)

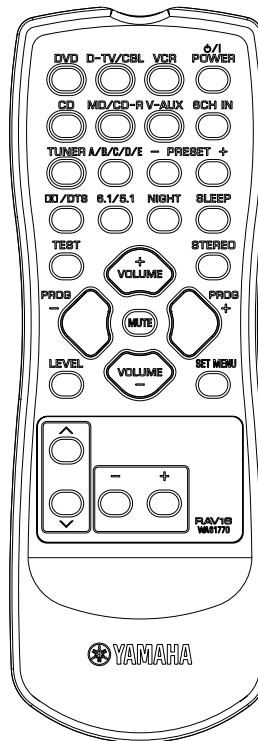
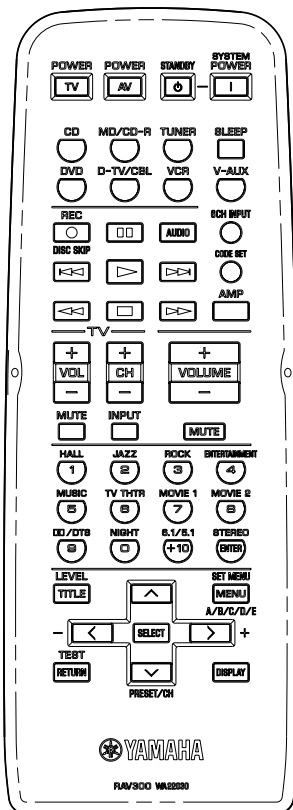

RX-V340/RX-V340RDS/
 HTR-5630/HTR-5630RDS/DSP-AX340

■ SPECIFICATIONS / 参考仕様

■ Audio Section / オーディオ部

Minimum RMS Output Power (Power Amp. Section) /

定格出力 (パワーアンプ部)

(1 kHz, 0.1 % THD, 6 ohms)

MAIN L/R	
U, C, J models	70 W + 70 W
A, B, G, L, R, T, K models	60 W + 60 W
CENTER	
U, C, J models	70 W
A, B, G, L, R, T, K models	60 W
REAR L/R	
U, C, J models	70 W + 70 W
A, B, G, L, R, T, K models	60 W + 60 W

(1 kHz, 0.7 % THD, 6 ohms)

MAIN L/R	
U, C models	75 W + 75 W
A, B, G, T, K models	65 W + 65 W
CENTER	
U, C models	75 W
A, B, G, T, K models	65 W
REAR L/R	
U, C models	75 W + 75 W
A, B, G, T, K models	65 W + 65 W

Maximum Power / 実用最大出力

(EIAJ, 1 kHz, 10 % THD, 6 ohms)

MAIN L/R	
R, T, K models	80 W + 80 W
J model	90 W + 90 W
CENTER	
R, T, K models	80 W
J model	90 W
REAR L/R	
R, T, K models	80 W + 80 W
J model	90 W + 90 W

DIN Standard Output Power Per Channel / DINパワー

[B, G, L models]

(1 kHz, 0.7 % THD, 4 ohms)

MAIN L/R	75 W + 75 W
CENTER	75 W
REAR L/R	75 W + 75 W

IEC Power / IECパワー [B, G, L models]

1 kHz, 0.1 % THD, 6 ohms 60 W + 60 W

Dynamic Power Per Channel / ダイナミックパワー (IHF)

U, C, J models (6/4/2 ohms) 85/100/115 W
A, B, G, L, R, T, K models (6/4/2 ohms) 75/95/105 W

Dynamic Headroom / ダイナミックヘッドルーム [U, C models]

6 ohms 0.84 dB

Input Sensitivity / Input Impedance (入力感度 / 入力インピーダンス)

CD, etc. 150 mV / 47 k-ohms
EXT. DECODER
MAIN L/R, CENTER, SURROUND L/R, SUB WOOFER
..... 150 mV / 47 k-ohms

Maximum Input Signal Level / 最大許容入力

(1 kHz, 0.5 % THD, Effect On)

CD, etc. 2.0 V or more

Output Level / Output Impedance (出力電圧/出力インピーダンス)

REC OUT 150 mV / 1.2 k-ohms
SUB WOOFER (MAIN SP: Small) 4 V / 1.2 k-ohms

Headphone Jack Rated Output / Impedance (ヘッドフォン出力/出力インピーダンス)

CD, etc. (1 kHz, 150 mV, 8 ohms) 0.3 V / 470 ohms

Frequency Response / 周波数特性

CD, etc. to MAIN L/R (10 Hz to 100 kHz) 0 / -3.0 dB

Total Harmonic Distortion / 全高調波歪率

(1 kHz, 30 W, 6 ohms)

CD, etc. (Effect Off) to MAIN L/R SP OUT 0.06 % or less

Signal to Noise Ratio / 信号対雑音比 (IHF-A network)

CD, etc. (Input shorted, EFFECT OFF) to MAIN L/R SP OUT

250mV 100 dB or more

Residual Noise / 残留ノイズ (IHF-A network)

MAIN L/R SP OUT 150 μ V or less

Channel Separation / チャンネルセパレーション

(Vol -30 dB, Effect Off)

CD, etc. (Input 5.1 k-ohms shorted, 1 kHz / 10 kHz)

..... 60 dB or more / 45 dB or more

Tone Control Characteristics / トーンコントロール特性

BASS

Boost/Cut \pm 10 dB (100Hz)

TREBLE

Boost/Cut \pm 10 dB (20 kHz)

Filter Characteristics / フィルター特性

MAIN, REAR L/R SP Small (H.P.F.) 90 Hz / 12 dB oct.

SUBWOOFER (L.P.F.) 90 Hz / 18 dB oct.

■ Video Section / ビデオ部

Video Signal Type / ビデオ信号方式

U, C, R, T, K, J models NTSC

A, B, G, L models PAL

Video Signal Level / ビデオ信号

..... 1 Vp-p / 75 ohms

Maximum Input Level / 最大許容入力

..... 1.5 Vp-p

Signal to Noise Ratio / 信号対雑音比

..... 50 dB or more

Monitor Out Frequency Response / モニターアウト周波数帯域

Video Signal Level 5 Hz to 10 MHz, -3 dB

■ FM Section / FM部

Tuning Range

U, C models 87.5 to 107.9 MHz

A, B, G, L, T, K models 87.50 to 108.00 MHz

R model 87.5 to 108.0 / 87.50 to 108.00 MHz

J model 76.0 to 90.0 MHz

50dB Quieting Sensitivity / 50dB SN感度 (IHF)

(1 kHz, 100 % Mod.)

Mono 2.0 μ V (17.3 dBf)

Stereo 25 μ V (39.2 dBf)

Usable Sensitivity / 実用感度 (IHF)

Mono 1.0 μ V (11.2 dBf)

Selectivity / 選択度

at 400 kHz 70 dB

Signal to Noise Ratio / 信号対雑音比 (IHF)

Mono / Stereo 76 dB / 70 dB

Harmonic Distortion / 歪率

(1 kHz)

Mono/Stereo 0.2 % / 0.3 %

Stereo Separation / ステレオセパレーション

1 kHz 42 dB

Frequency Response / 周波数特性

20 Hz to 15 kHz +0.5 / -2 dB

Antenna Input / アンテナ入力

..... 75 ohms unbalanced

■ AM Section / AM部

Tuning Range / 受信周波数範囲

U, C models	530 to 1,710 kHz
A, B, G, L, T, K, J models	531 to 1,611 kHz
R model	530 to 1,710 / 531 to 1,611 kHz

Usable Sensitivity / 実用感度

.....	300 μ V/m
-------	---------------

Antenna / アンテナ入力

.....	Loop Antenna
-------	--------------

■ General / 総合

Power Supply / 電源電圧

U, C models	AC 120 V, 60 Hz
A model	AC 240 V, 50 Hz
B, G, L models	AC 230 V, 50 Hz
R model	AC 110-120/220-240 V, 50/60 Hz
T model	AC 220 V, 50 Hz
K model	AC 220 V, 60 Hz
J model	AC 100V, 50/60 Hz

Power Consumption / 消費電力

U, C models	210 W / 280 VA
A, B, G, L, R, T, K models	210 W
J model	160 W

Standby Power Consumption (reference data) / 待機電力(参考値)

.....	0.8 W
-------	-------

Maximum Power Consumption [R model]

5ch Drive, 10 % THD	500 W
---------------------------	-------

Dimensions / 寸法 (W x H x D)

.....	435 x 151 x 322 mm (17-1/8" x 5-15/16" x 12-11/16")
-------	---

Weight / 重量

.....	8.0 kg (17 lbs. 10 oz.)
-------	-------------------------

Finish / 仕上げ

RX-V340	Gold color (L, T) models Silver color (C, L, R) models
RX-V340RDS	Silver color (B, G) models Black color (B, G) models
HTR-5630	Gold color (T) models Silver color (U, C, A, R, T, K) models Black color (U, C, A, R) models
HTR-5630RDS	Silver color (B, G) models Black color (B, G) models
DSP-AX340	Gold color (J) model Silver color (J) model

Accessories / 付属品

Remote Control, Batteries (Manganese Dry), Indoor FM Antenna,
AM Loop Antenna

* Specifications are subject to change without notice due to product improvements.

※ 参考仕様および外観は予告なく変更されることがあります。

U	U.S.A. model	C	Canadian model
A	Australian model	B	British model
G	European model	L	Singapore model
R	General model	T	Chinese model
K	Korean model	J	Japanese model



Manufactured under license from Dolby Laboratories.

"Dolby", "Pro Logic" and the double-D symbol are trademarks of Dolby Laboratories.



"DTS" and "DTS Digital Surround" are registered trademarks of Digital Theater Systems, Inc.



AACロゴマークはドルビーラボラトリーズの商標です。

"SILENT CINEMA" is a trademark of YAMAHA CORPORATION.
「サイレントシアター/SILENT THEATER」はヤマハ株式会社の登録商標です。

• Set Menu Table / セットメニュー

The inside of [] shows initialization.

[]内は初期設定を示します。

Category	No.	MAIN MENU	SUB MENU	VALUE [INITIAL]
BASIC	1	SETUP	ROOM : S >M L	S/[M]/L
			SUBWOOFER YES	[YES]/NONE
			SPEAKERS 5spk	2/3/4/[5]
			>SET CANCEL	[SET]/CANCEL
			Check : Test Tone	
			Check OK? Yes	[Yes]/No
	2	SP LEVEL	L ----- ----- R	[Center] ±10step
			C ----- -----	[Center] ±10step
			RL ----- -----	[Center] ±10step
			RR ----- -----	[Center] ±10step
SWFR -----			[0dB] -40step	
SOUND	1	SPEAKER SET	1A CENTER SML	LRG/[SML]/NON
			1B MAIN LARGE	[LARGE]/SMALL
			1C REAR LR SML	LRG/[SML]/NON
			1D BASS BOTH	MAIN/[BOTH]
	2	SP DISTANCE	UNIT	meters(m)/feet(ft)
			MAIN L/R 3.00m	0.3 to 24m [3.00m]/0.1m step
			CENTER 3.00m	0.3 to 24m [3.00m]/0.1m step (Effective distance difference 1.5m)
			REAR LR 3.00m	0.3 to 24m [3.00m]/0.1m step
			MAIN L/R 10.0	1 to 80feet [10.0feet]/0.5feet step
			CENTER 10.0	1 to 80feet [10.0feet]/0.5feet step (Effective distance difference 5feet)
			REAR LR 10.0	1 to 80feet [10.0feet]/0.5feet step
	3	LFE LEVEL	SP LFE 0	-20dB to [0dB]/1dB step
			HP LFE 0	-20dB to [0dB]/1dB step
	4	D. RANGE	SP D.R > MAX	MIN/STD/[MAX]
			HP D.R > MAX	MIN/STD/[MAX]
	5	CENTER GEQ	100Hz - - 0	-6dB to +6dB [0dB]/1dB step
			300Hz - - 0	-6dB to +6dB [0dB]/1dB step
			1kHz - - 0	-6dB to +6dB [0dB]/1dB step
			3kHz - - 0	-6dB to +6dB [0dB]/1dB step
			10kHz - - 0	-6dB to +6dB [0dB]/1dB step
	6	HP TONE CTRL	HP BASS 0	-6dB to +3dB [0dB]/1dB step
			HP TRBL 0	-6dB to +3dB [0dB]/1dB step
	INPUT	1	I/O ASSIGN	1A (1) DVD 1A (2) CD
INPUT MODE			2 >AUTO LAST	[AUTO]/LAST
OPTION	1	DISPLAY SET	1 DIMMER 0	-4 to [0]/1 step
	2	MEMORY GUARD	2 M GUARD OFF	[OFF]/ON
	3	AUDIO MUTE	3 MUTE: MUTE	[MUTE]/-50dB/-20dB
	4	DUAL MONO (J Only)		[MAIN]/SUB/ALL

• The variable range of the parameter (Min/Max/Step) / パラメーターの可変範囲 (最小/最大/ステップ)

		Unit
DSP LEVEL	-6/+3/1	dB
DELAY	1/99/1	ms

5ch Stereo Parameter		Unit
CT LEVEL	0/100/1	%
RL LEVEL	0/100/1	%
RR LEVEL	0/100/1	%

Pro Logic II Music Parameter		Unit
PANORAMA	OFF/ON	
DIMENSIONS	-3/+3/1	
CT WIDTH	0/7/1	

INTERNAL VIEW

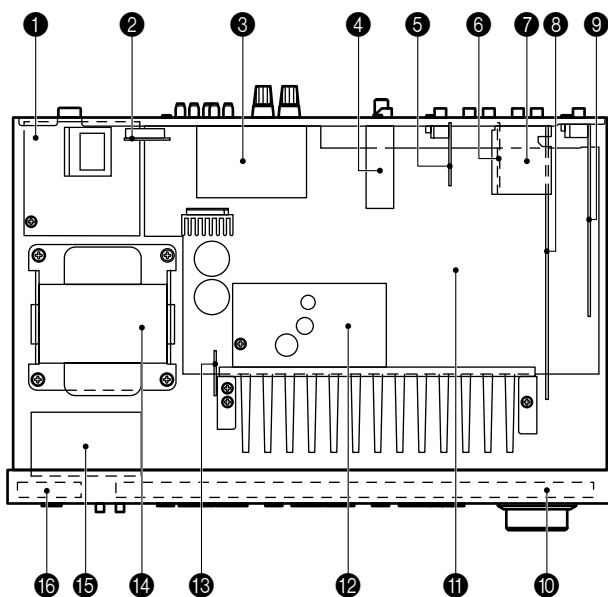

- ① MAIN (2) P.C.B.
- ② FUNCTION (7) P.C.B. (R model only)
- ③ MAIN (4) P.C.B.
- ④ Tuner
- ⑤ MAIN (3) P.C.B.
- ⑥ FUNCTION (3) P.C.B.
- ⑦ FUNCTION (6) P.C.B.
- ⑧ FUNCTION (1) P.C.B.
- ⑨ DSP P.C.B.
- ⑩ FUNCTION (2) P.C.B.
- ⑪ MAIN (1) P.C.B.
- ⑫ FUNCTION (4) P.C.B.
- ⑬ FUNCTION (8) P.C.B.
- ⑭ Power Transformer
- ⑮ MAIN (5) P.C.B.
- ⑯ FUNCTION (5) P.C.B.

■ DISASSEMBLY PROCEDURES / 分解手順

(Remove parts in the order as numbered.)

Disconnect the power cable from the AC outlet.

(番号順に部品を取り外してください。)

AC電源コンセントから、電源コードを抜いてください。

1. Removal of Top Cover

- a. Remove 4 screws (①) and 4 screws (②). (Fig. 1)
- b. Slide the Top Cover rearward to remove it. (Fig. 1)

1. トップカバーの外し方

- a. ①のネジ4本、②のネジ4本を外します。(Fig. 1)
- b. トップカバーを後方へスライドさせ、取り外します。(Fig. 1)

2. Removal of Front Panel Unit

- a. Loosen the harness fixture fixing the cable.
- b. Remove CB472 and CB654. (Fig. 1)
- c. Remove 5 screws (③).
- d. Release a hook on right side of the Front Panel Unit, then slide the Front Panel Unit forward. (Fig. 1)
- e. Remove 3 screws (④).
- f. Remove the MAIN (5) P.C.B. and then remove the Front Panel Unit. (Fig. 1)

2. フロントパネルユニットの外し方

- a. ケーブルを固定している束線止めをゆるめます。
- b. CB472、CB654を外します。(Fig. 1)
- c. ③のネジ5本を外します。
- d. 右側のフックをはずし、フロントパネルユニットを前方へ引き出します。(Fig. 1)
- e. ④のネジ3本を外します。
- f. MAIN(5)を外し、フロントパネルユニットを取り外します。(Fig. 1)

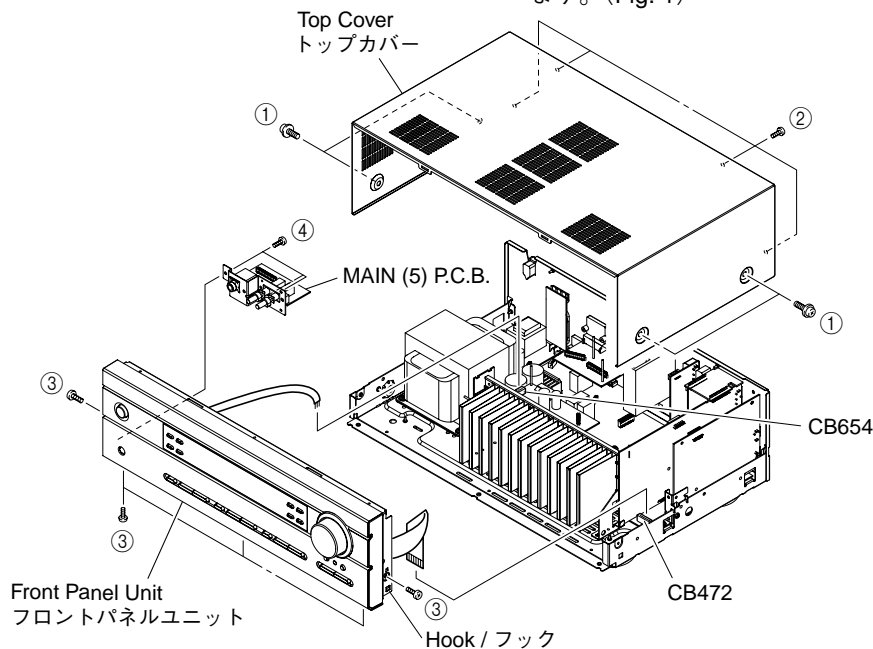

Fig. 1

3. Removal of DSP P.C.B.

- a. Remove 1 screw (⑤). (Fig. 2)
- b. Remove 2 screws (⑥). (Fig. 3)
- c. Remove CB803. (Fig. 2)
- d. Remove the DSP P.C.B. with the Support/DSP. (Fig. 2)

3. DSP P.C.B.の外し方

- a. ⑤のネジ1本を外します。(Fig. 2)
- b. ⑥のネジ2本を外します。(Fig. 3)
- c. CB803を外します。(Fig. 2)
- d. DSP P.C.B.をサポート/DSPと共に取り外します。(Fig. 2)

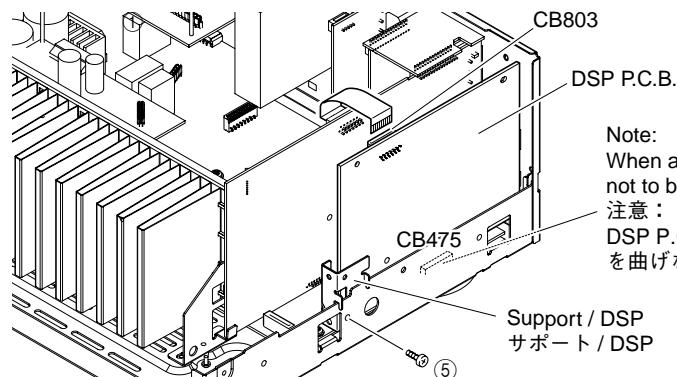

Note:

When assembling the DSP P.C.B., be careful not to bend the pin of the connector (CB475).

注意:

DSP P.C.B.を取り付けるとき、CB475のピンを曲げないように注意してください。

Fig. 2

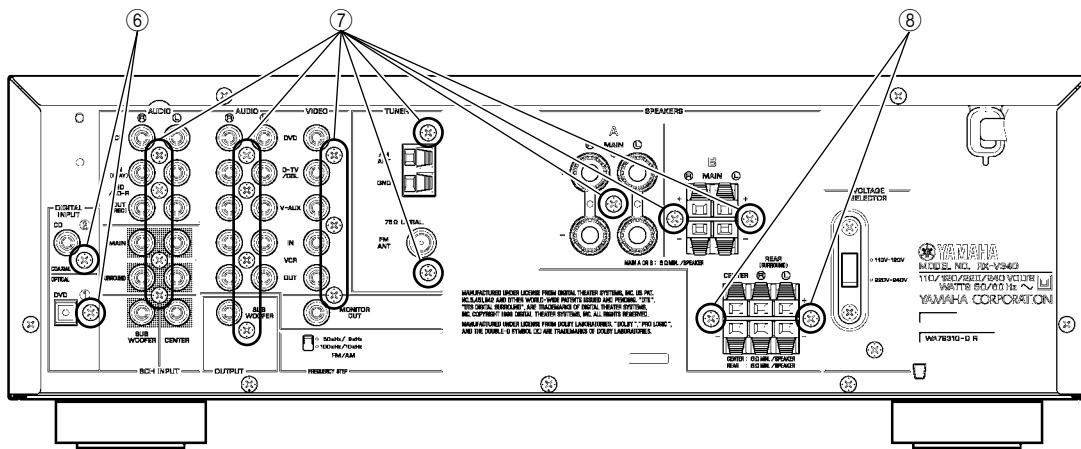

Fig. 3

4. Removal of MAIN (3), MAIN (4), FUNCTION (3), FUNCTION (6) P.C.B.s and Tuner

- a. Remove CB281 and CB471. (Fig. 4)
- b. Remove 16 screws (7). (Fig. 3)
- c. Remove MAIN (3), MAIN (4), FUNCTION (3), FUNCTION (6) P.C.B.s. and the Tuner. (Fig. 4)

4. MAIN (3)、MAIN (4)、FUNCTION (3)、FUNCTION (6)、TUNERの外し方

- a. CB281、CB471を外します。(Fig. 4)
- b. 7のネジ16本を外します。(Fig. 3)
- c. MAIN (3)、MAIN (4)、FUNCTION (3)、FUNCTION (6)、TUNERを取り外します。(Fig. 4)

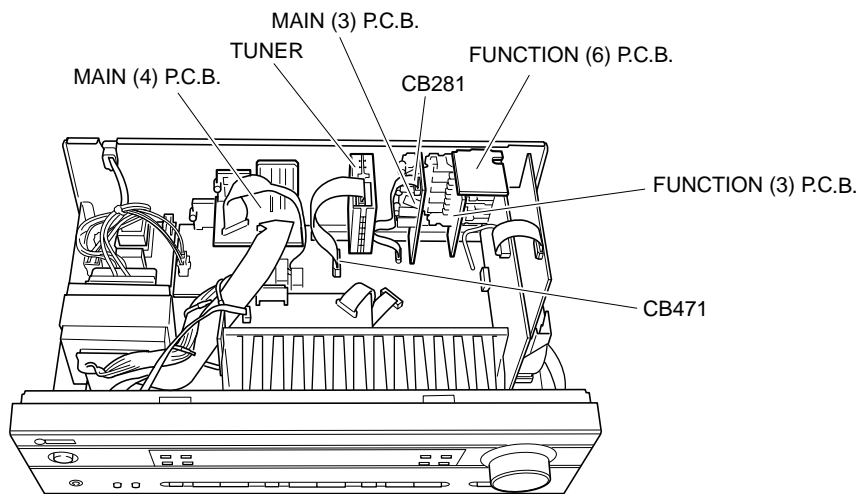

Fig. 4

5. Removal of MAIN (1), FUNCTION (1) and FUNCTION (8) P.C.B.s

- Remove CB303 and CB304. (Fig. 5)
- Remove 2 screws (⑧). (Fig. 3)
- Remove 7 screws (⑨). (Fig. 5)
- Remove MAIN (1), FUNCTION (1) and FUNCTION (8) P.C.B.s.. (Fig. 5)

5. MAIN (1)、FUNCTION (1)、FUNCTION (8) P.C.B.の外し方

- CB303、CB304を外します。(Fig. 5)
- ⑧のネジ2本を外します。(Fig. 3)
- ⑨のネジ7本を外します。(Fig. 5)
- MAIN (1)、FUNCTION (1)、FUNCTION (8) P.C.B.を取り外します。(Fig. 5)

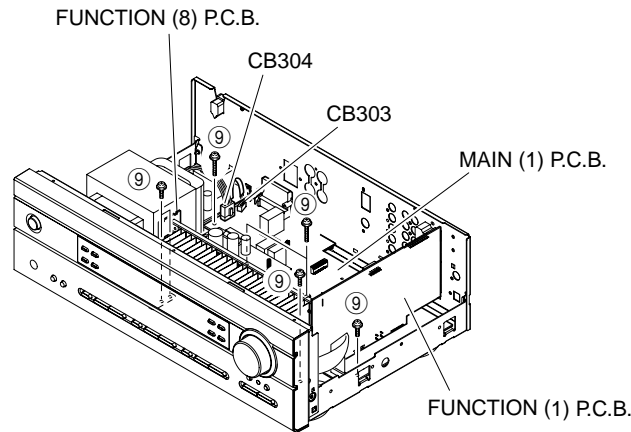

Fig. 5

When checking the P.C.B.:

- Reconnect all cables (connectors) that have been disconnected.
- When connecting the flat cable, use care for the polarity.
- The MAIN (1) P.C.B. removed from the rear panel does not work because its grounding is loose. Be sure to connect the ground (G302 and G471) of MAIN (1) P.C.B. to the chassis or Rear Panel with a jumper wire or the like.
- The P.C.B. removed from the rear panel does not work because its grounding is loose. Be sure to connect the ground of each P.C.B. to the chassis or GND with a jumper wire or the like.
- FUNCTION P.C.B. and MAIN P.C.B. works even with the DSP P.C.B. removed.

P.C.B.チェックをする場合には

- 外したケーブル(コネクタ)をすべて接続してください。
- フラットケーブルを接続する際、極性に注意してください。
- MAIN(1)P.C.B.のアース2箇所(G302、G471)をリード線等でシャーシまたはリアパネルに接続してください。
- リアパネルから外したP.C.B.はアースが浮いて動作しませんので、各P.C.B.のアースをリード線等でシャーシまたはGNDに接続してください。
- FUNCTION P.C.B.およびMAIN P.C.B.はDSP P.C.B.を外した状態でも動作します。

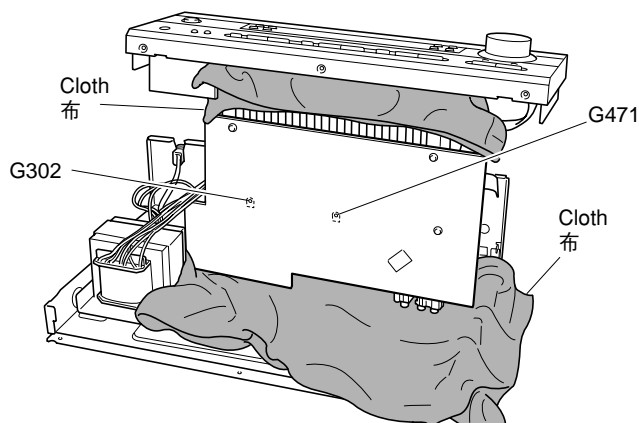

Fig. 6

■ SELF DIAGNOSIS FUNCTION (DIAG) / 自己診断機能 (ダイアグ)

There are 15 DIAG menu items, each of which has sub-menu items.

Listed in the table below are menu items and sub-menu items.

Note that not all menu items listed will apply to the models covered in this service manual.

本機には、検査、測定、不良個所の発見を目的にした自己診断機能(ダイアグ)があります。

ダイアグメニューは15個あり、そのそれぞれにサブメニューがあります。(ダイアグのメニュー操作は本体で行います。) 下表はメニュー一覧です。

No	DIAG menu	sub-menu
1	DSP THROUGH 1. ANALOG BYPASS	1. ANALOG BYPASS
		2. YSS 0dB
		3. YSS Front 0dB
		4. YSS FULL BIT
		5. YSS FULL BIT F
2	RAM THROUGH 2. RAM 0dB	RAM 0dB
3	PRO LOGIC / NEO6 3. PRO LOGIC I	1. PRO LOGIC I
		2. PRO LOGIC II
		3. Neo:6 (Not applied to these models / このモデルには適用されません)
4	SPEAKERS SET 4. MAIN: SML 0dB	1. MAIN: SMALL 0dB
		2. CENTER: NONE
		3. LFE/BASS: MAIN
		4. Front Mix: 5ch
		5. Rear Center power (Not applied to these models / このモデルには適用されません)
		6. Tone Control Flat
		7. Tone Control +10dB
		8. Tone Control -10dB
5	MARGIN CHECK 5. MAIN 12dB	1. MAIN 12 dB margin
		2. MAIN 15 dB margin
6	OTHER INPUT 6. EXTERNAL DEC	EXTERNAL DECODER
7	DISPLAY CHECK 7. VFD CHECK	1. VFD CHECK (Initial display / 初期表示)
		2. VFD DISP OFF (All segments OFF / 全セグメント消灯)
		3. VFD DISP ALL (All segments ON 100% / 全セグメント点灯100%)
		4. VFD DIMMER (All segments ON 50% / 全セグメント点灯50%)
		5. CHECKED PATTERN (ON in lattice / 格子状点灯)
8	MANUAL TEST 8. TEST ALL	1. TEST ALL
		2. TEST MAIN L
		3. TEST CENTER
		4. TEST MAIN R
		5. TEST REAR R
		6. TEST REAR CENTER (Not applied to these models / このモデルには適用されません)
		7. TEST REAR L
		8. TEST LFE
9	FACTORY PRESET 9. PRESET INHI	1. PRESET INHIBITED (memory initialization inhibited / メモリーの初期化禁止)
		2. PRESET RESERVED (memory initialized / メモリーの初期化)
10	AD DATA CHECK /FAN TEST DC: 98%PS: 98%	1. DC/PS (protection)
		2. THM/Fan (Not applied to these models / このモデルには適用されません)
		3. REC-OUT (Not applied to these models / このモデルには適用されません)
		4. IMP SW/POWER LIMIT
		5. K0/K1 (panel key)
		6. FAN DRIVE TEST: HIGH (Not applied to these models / このモデルには適用されません)
		7. FAN DRIVE TEST: MID (Not applied to these models / このモデルには適用されません)
		8. FAN DRIVE TEST: LOW (Not applied to these models / このモデルには適用されません)

No	DIAG menu	sub-menu
11	IF STATUS I Si: 440308C000	1. INSIDE STATUS 1 (5 Byte)
		2. INSIDE STATUS 2 (3 Byte)
		3. CHANNEL STATUS 1 (5 Byte)
		4. CHANNEL STATUS 2 (5 Byte)
		5. CHANNEL STATUS 3 (5 Byte)
		6. CHANNEL STATUS 4 (5 Byte)
		7. CHANNEL STATUS 5 (4 Byte)
		8. BSI (YSS) 1 (5 Byte)
		9. BSI (YSS) 2 (5 Byte)
		10. BSI (YSS) 3 (5 Byte)
		11. BSI (YSS) 4 (4 Byte)
		12. BSI (CS) 1 (5 Byte)
		13. BSI (CS) 2 (5 Byte)
		14. BSI (CS) 3 (5 Byte)
		15. BSI (CS) 4 (5 Byte)
		16. BSI (CS) 5 (1 Byte)
		17. YSS938-1 (5 Byte)
		18. YSS938-2 (5 Byte)
		19. YSS938-3 (4 Byte)
		20. SECOND DECODER (3 Byte)
		21. Mute Trigger (5 Byte)
12	DSP RAM CHECK YSS BUS: NoEr	1. YSS938 BUS CHECK 2. PLD/SRAM BUS CHECK
13	SD DL CODE RDV: XXXXXXXX	1. ROM DATA Version
		2. TOC Area 0
		3. TOC Area 1
		4. TOC Area 2
		5. TOC Area 3
		6. TOC Area 4
		7. TOC Area 5
		8. Sum check Area 0
		9. Sum check Area 1
		10. Sum check Area 2
		11. Sum check Area 3
		12. Sum check Area 4
		13. Sum check Area 5
14	SOFT SWITCH 14. SW : PCB	1. SW MODE
		2. MODEL SETTING
		3. TUNER DESTINATION
		4. RDS EXIST
		5. ZONE 2 EXIST
		6. VIDEO FORMAT
15	ROM VERSION/CHECK SUM/ PORT VER. XXXXX	1. VERSION
		2. CHECK SUM ALL/PROGRAM
		3. PORT
		4. AAC PORT

RX-V340/RX-V340RDS/
HTR-5630/HTR-5630RDS/DSP-AX340

● Starting DIAG

Press the "STANDBY/ON" key while simultaneously pressing those two keys of the main unit as indicated in the figure below.

Keys of main unit / 本体キー

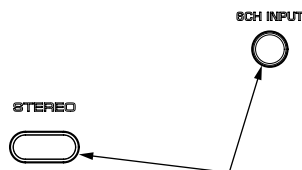

Turn on the power while pressing these keys.
これらのキーを同時に押しながら、パワーオンする。

● Starting DIAG in the protection cancel mode

If the protection function works and causes hindrance to trouble diagnosis, cancel the protection function as described below, and it will be possible to enter the DIAG mode. (The protection functions other than the excess current detect function will be disabled.)

Press the "STANDBY/ON" key while simultaneously pressing those two keys indicated in the figure above. At this time, keep pressing those two keys for 3 seconds or longer.

In this mode, the "SLEEP" segment of the FL display of the main unit flashes to indicate that the mode is DIAG mode with the protection functions disabled.

CAUTION!

Using this product with the protection function disabled may cause damage to itself. Use special care for this point when using this mode.

● Canceling DIAG

[1] Before canceling DIAG, execute setting for PRESET of DIAG menu No.9 (Memory initialization inhibited or Memory initialized).

* In order to keep the user memory stored, be sure to select PRESET INHIBITED (Memory initialization inhibited).

[2] Turn off the power by pressing the "STANDBY/ON" key of the main unit.

● ダイアグの起動

本体の下図に示すキーを同時に押しながら"STANDBY/ON"キーを押すと、ダイアグが起動します。

● プロテクション解除モードでの起動

プロテクションが動作することにより、故障箇所の診断に支障をきたすような場合は、次の方法によりプロテクションを解除した状態でダイアグモードに入ることが出来ます。(過電流検出以外のプロテクション動作を解除する)

上図のキーを同時に押しながら"STANDBY/ON"キーを押します。このとき、上図のキーを3秒以上押し続けてください。

このモードでは本体FLの"SLEEP"セグメントが点滅し、プロテクションを解除した状態でのダイアグモードであることを知らせます。

注意!

プロテクションを解除した状態でのダイアグモードは、危険な状態でもプロテクションが作動しないため、動作させると、機器を破壊することがあります。このモードを使用する場合は十分注意してください。

● ダイアグの解除

① ダイアグを解除する前に、ダイアグメニューNo.9のFACTORY PRESET (メモリーの初期化禁止/またはメモリーの初期化)の設定をします。

※ ユーザーメモリーを保持したい場合は、必PRESET INHIBITED (メモリー初期化禁止)を選択してください。

② 本体の"STANDBY/ON"キーを押し、パワーオフにします。

● Display provided when DIAG started

The FL display of the main unit displays the protection function history data and the version (1 alphabet) and the DIAG menu [sub-menu (ANALOG BYPASS) of DIAG menu No.1 DSP THROUGH] a few seconds later.

● ダイアグ起動時の表示

本体のFLディスプレイにプロテクション履歴情報とバージョン(英1文字)が表示され、数秒後にダイアグメニュー(No.1 DSP THROUGHのサブメニューANALOG BYPASS)になります。

When there is no history of protection function:

プロテクション履歴がない場合:

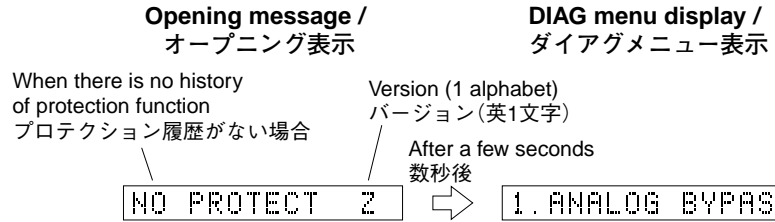

When there is a history of protection function:

プロテクション履歴がある場合:



Cause: An excessive current flowed through the power amplifier.

原因：パワーアンプに過電流が流れた。

Supplementary information: As current through the power transistor is detected, the abnormal channel can be identified by checking the current detect transistor.

補足：パワートランジスタの電流を検出していますので、電流検出トランジスタをチェックすれば異常チャネルが特定できます。

Turning on the power without correcting the abnormality will cause the protection function to work immediately and the power supply will instantly be shut off.

異常状態のままパワーオンすると、瞬時にプロテクションがかかり、すぐに電源が切れます。

Note)

- Applying the power to a unit without correcting the abnormality can be dangerous and cause additional circuit damage.
- The output transistors in each amplifier channel should be checked for damage before applying any power.
- Amplifier current should be monitored by measuring across the emitter resistors for each channel.

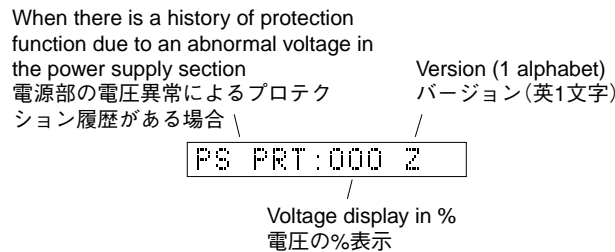

Cause: The voltage in the power supply section is abnormal.

原因：電源部の電圧が異常。

Supplementary information: The abnormal voltage is displayed in % based on 5V as 100%.

補足：異常時の電圧の状態を、5Vを100%とした値で%表示します。

Turning on the power without correcting the abnormality will cause the protection function to work 1 second later and the power supply will be shut off.

異常状態のままパワーオンすると、1秒後にプロテクションがかかり、電源が切れます。

When there is a history of protection function due to abnormal DC output
 DC出力異常によるプロテクション履歴がある場合

Version (1 alphabet)
バージョン(英1文字)

DC PRT: Z

Cause: DC output of the power amplifier is abnormal.

原因：パワーアンプのDC出力が異常。

Turning on the power without correcting the abnormality will cause the protection function to work 3 seconds later and the power supply will be shut off.

異常状態のままパワーオンすると、3秒後にプロテクションがかかり、電源が切れます。

When there is a history of protection function due to excessive heat sink temperature
 放熱器の異常温度によるプロテクション履歴がある場合

Version (1 alphabet)
バージョン(英1文字)

TMP PRT: 000 Z

Voltage display in %
電圧の%表示

Cause: The temperature of the heat sink is excessive.

原因：放熱器の温度が異常。

Supplementary information: The abnormal voltage is displayed in % based on 5V as 500%.

補足：異常時の電圧の状態を、5Vを500%とした値で%表示します。

Turning on the power without correcting the abnormality will cause the protection function to work 1 second later and the power supply will be shut off.

異常状態のままパワーオンすると、1秒後にプロテクションがかかり、電源が切れます。

- * Additional causes of protection can be due to loose connections, associated components, CPU, etc.
- * For the protection voltage value, refer to DIAG menu No.10 described later.

- ※ 前記の異常原因の他に、コネクタのはずれやCPU周辺などに原因があります。
- ※ プロテクションの電圧値に関しては、後述のダイアグメニューNo.10を参照してください。

● History of protection function

When the protection function has worked, its history is stored in memory with a backup. Even if no abnormality is noted while servicing the unit, an abnormality which has occurred previously can be defined as long as the backup data has been stored.

The history of the protection function is cleared when DIAG is cancelled by selecting PRESET RESERVED (Memory initialized) of DIAG menu No.9 or when the backup data is erased.

● プロテクションの履歴

プロテクションが働いた場合、履歴をバックアップして記憶しています。サービスのときに異常が認められなくても、バックアップが残っていれば、お客様のところで起きた異常を区別できます。

プロテクションの履歴は、ダイアグメニューNo.9でPRESET RESERVED(メモリーの初期化)を選んでダイアグを解除した場合や、バックアップが消えたときにはクリアされます。

● Display during menu operation

During the DIAG operation, the function at work is indicated on the FL indicator. The contents displayed during the function operation are described in the later section on details of functions.

● メニュー動作中の表示

ダイアグ中、本体のFLディスプレイに動作中の機能が表示されます。機能動作中の表示内容については、後述の機能詳細で記述します。

● Operation procedure of DIAG menu and SUB-MENU

There are 15 MENU items, each of which has some SUB-MENU items.

DIAG menu selection

Main unit: Select the menu using ▷ (Forward) and ◁ (Reverse) keys of PRESET/TUNING.

SUB-MENU selection

Main unit: Select the sub-menu using ▷ (Forward) and ◁ (Reverse) keys of PROGRAM.

● ダイアグメニューとサブメニューの操作

ダイアグにはNo.1～15のメニューがあり、そのそれぞれにサブメニューがあります。

ダイアグメニューの選択

本体キーでの操作：PRESET/TUNING ▷ (順送り), ◁ (逆送り)キーで選択します。

サブメニューの選択

本体キーでの操作：PROGRAM ▷ (順送り), ◁ (逆送り)キーで選択します。

Keys of main unit / 本体キー

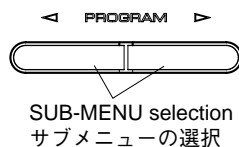

● Functions in DIAG mode

In addition to the DIAG menu items, functions as listed below are available.

- Input selection, 6CH input
- Center/Rear/Sub-woofer level adjustment
- Muting
- Power on/off
- Master volume

- * Functions related to the tuner and the set menu are not available.
- * It is possible to confirm Menu No.11 IF STATUS while keeping the signal process (operation status) of each DIAG menu by using the input mode key of the main unit.

● ダイアグ中の機能

ダイアグメニューの他に、以下の機能が動作します。

- インプット切り換え、6CHインプット
- センター、リア、サブウーファーレベル調整
- ミューティング
- パワーオン/オフ
- マスターボリューム

※ チューナー関連、セットメニュー関連は機能しません。

※ 本体のINPUT MODEキーにより、各ダイアグメニューの信号処理(動作状態)を維持したままメニューNo.11 “IF STATUS”の確認ができます。

● Initial settings used to start DIAG

The following initial settings are used when starting DIAG. When DIAG is canceled, these settings are restored to those before starting DIAG.

- Master volume: -40dB
- Input: DVD (6CH INPUT OFF)
- Effect level: 0dB
- Audio mute: OFF
- Speaker setting: LARGE / BASS OUT = BOTH
- DIAG menu: DSP THROUGH (1. ANALOG BYPASS)

● ダイアグ開始時の初期設定

ダイアグ開始時に以下のような設定になります。ダイアグ解除時にはダイアグ開始前の状態に戻ります。

- マスターボリューム：-40dB
- インプット：DVD (6CH INPUT オフ)
- エフェクトレベル：0dB
- オーディオミュート：オフ
- スピーカー設定：LARGE / BASS OUT = BOTH
- ダイアグメニュー：DSP THROUGH (1. ANALOG BYPASS)

● Details of DIAG menu

With full-bit output specified in some modes, it is possible to execute 0dBFS output without head margin in each channel.

1. DSP THROUGH

Main DSP of YSS938 is selected for MAIN L/R output.

ANALOG BYPASS

- The signal for L/R is output as it is without passing through the DSP section.

1. ANALOG BYPASS

Reference data

INPUT: DVD ANALOG

SWFR: 50Hz, Others: 1kHz

Input level	Volume	SPEAKER OUTPUT (1kHz)			SUBWOOFER OUTPUT (50Hz)
		MAIN L/R	CENTER	RL/RR	
Both ch, -20 dBm	-10 dB	+10.8 dBm	- ∞	- ∞	- ∞

YSS 0dB

- The signal is output including the head margin.
Head margin:
Main L/R: 0dBFS, Center: -6dBFS,
RL/RR: -12dBFS,
SWFR: Add L/R signal at -20dBFS.

YSS 0dB

- ヘッドマージンを含んで出力されます。
ヘッドマージン:
Main L/R: 0dBFS, Center: -6dBFS,
RL/RR: -12dBFS,
SWFR: L/Rを-20dBfsにて加算

1. YSS 0dB

Reference data

INPUT: DVD ANALOG

SWFR: 50Hz, Others: 1kHz

Input level	Volume	SPEAKER OUTPUT (1kHz)			SUBWOOFER OUTPUT (50Hz)
		MAIN L/R	CENTER	RL/RR	
Both ch, -20 dBm	-10 dB	+10.8 dBm	+10.8 dBm	+10.4 dBm	+0.8 dBm

YSS Front 0dB

- The front CH signal including the head margin is output at the main CH.
Head margin:
Main L/R: 0dBFS, Center: -6dBFS,
RL/RR: -12dBFS, SWFR: Add L/R signal at -20dBFS.

YSS Front 0dB

- ヘッドマージンを含んで、フロントCHがメインCHに出力されます。
ヘッドマージン:
Main L/R: 0dBFS, Center: -6dBFS,
RL/RR: -12dBFS,
SWFR: L/Rを-20dBfsにて加算

1. YSS Front0dB

Reference data

INPUT: DVD ANALOG

SWFR: 50Hz, Others: 1kHz

Input level	Volume	SPEAKER OUTPUT (1kHz)			SUBWOOFER OUTPUT (50Hz)
		MAIN L/R	CENTER	RL/RR	
Both ch, -20 dBm	-10 dB	+17.0 dBm	- ∞	- ∞	- ∞

YSS FULL BIT

- The signal is output in digital full bit without including the head margin. The SWFR signal is output but not in digital full bit.

YSS FULL BIT

- ヘッドマージンを含まず、デジタルフルビットで出力されます。SWFRは出力されますが、デジタルフルビットではありません。

1. YSS FULL BIT

Reference data

INPUT: DVD ANALOG

SWFR: 50Hz, Others: 1kHz

Input level	Volume	SPEAKER OUTPUT (1kHz)			SUBWOOFER OUTPUT (50Hz)
		MAIN L/R	CENTER	RL/RR	
Both ch, -20 dBm	-10 dB	+10.8 dBm	+10.8 dBm	+10.4 dBm	+0.8 dBm

YSS FULL BIT F

- The front CH signal is output in digital full bit at the main CH.

YSS FULL BIT F

- フロントCHがメインCHに、デジタルフルビットで出力されます

1. FULL BIT F

Reference data

INPUT: DVD ANALOG

SWFR: 50Hz, Others: 1kHz

Input level	Volume	SPEAKER OUTPUT (1kHz)			SUBWOOFER OUTPUT (50Hz)
		MAIN L/R	CENTER	RL/RR	
Both ch, -20 dBm	-10 dB	+10.8 dBm	- ∞	- ∞	- ∞

DSP THROUGH ~
YSS (Analog)

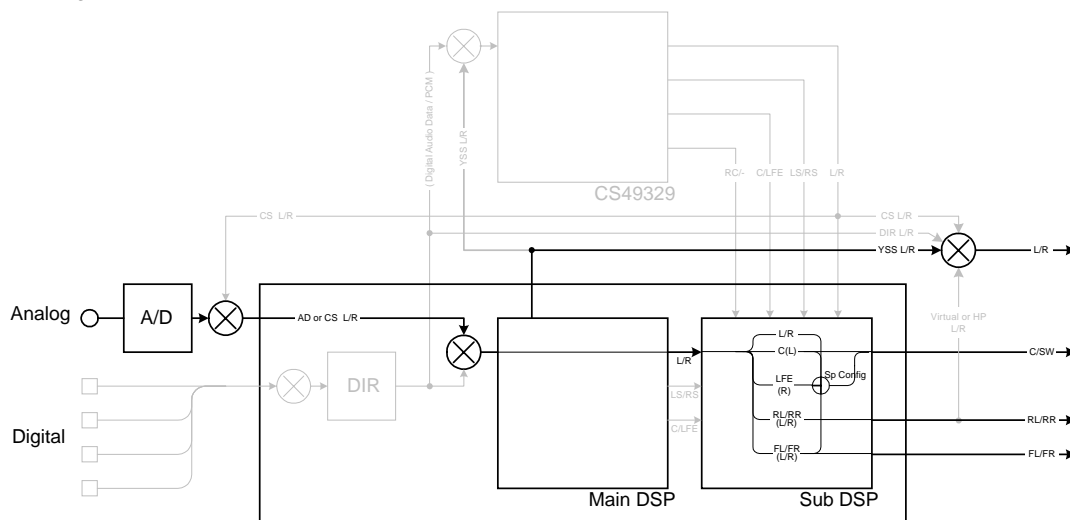

(Shaded items not used in this example)

2. RAM THROUGH

This function is for YSS938 only.

Only the CT signal is output through the Sub DSP – DRAM.

RAM 0dB

2. RAM 0dB

Reference data

INPUT: DVD ANALOG

SWFR: 50Hz, Others: 1kHz

Input level	Volume	SPEAKER OUTPUT (1kHz)			SUBWOOFER OUTPUT (50Hz)
		MAIN L/R	CENTER	RL/RR	
Both ch, -20 dBm	-10 dB	-∞	+5.0 dBm	-∞	-∞

2. RAM THROUGH

YSS938のみの動作です。

CTのみがSub DSP – DRAM経由で出力されます。

RAM 0dB

RAM THROUGH ~
(Auto)

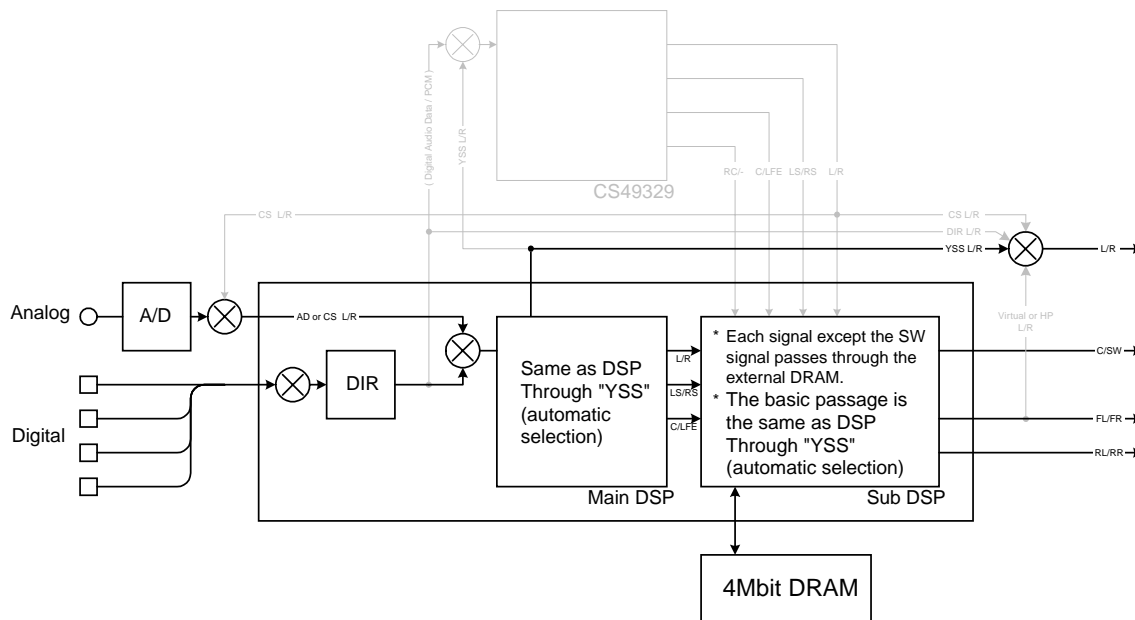

(Shaded items not used in this example)

3. PRO LOGIC

3. PRO LOGIC

PRO LOGIC I

PRO LOGIC I

3. PRO LOGIC I

Reference data
 INPUT: DVD ANALOG
 SWFR: 50Hz, Others: 1kHz

Input level	Volume	SPEAKER OUTPUT (1kHz)			SUBWOOFER OUTPUT (50Hz)
		MAIN L/R	CENTER	RL/RR	
Each ch, -20 dBm	-10 dB	+10.8 dBm	- ∞	- ∞	-9.2 dBm
Both ch, -20 dBm	-10 dB	- ∞	+13.8 dBm	- ∞	- ∞

PRO LOGIC II

PRO LOGIC II

3. PRO LOGIC II

Reference data
 INPUT: DVD ANALOG
 SWFR: 50Hz, Others: 1kHz

Input level	Volume	SPEAKER OUTPUT (1kHz)			SUBWOOFER OUTPUT (50Hz)
		MAIN L/R	CENTER	RL/RR	
Each ch, -20 dBm	-10 dB	+10.8 dBm	- ∞	- ∞	-9.2 dBm
Both ch, -20 dBm	-10 dB	- ∞	+13.8 dBm	- ∞	- ∞

The L/C/R/RL/RR signals undergo the Pro-Logic processing and C/RL/RR signals are output through Sub DSP-DRAM. Main DSP is selected for MAIN L/R output. Using the sub-menu, it is possible to select PRO LOGIC I, II (Movie). The Auto Input Balance function is always off. When the Dolby Digital Multi input is used, the function is the same as in the Dolby Digital Normal mode. The LFE signal is not output when decoding in the PRO LOGIC I, II mode.

L/C/R/RL/RRはYSS938によりプロロジック処理され、C/RL/RRはSub DSP-DRAM経由で出力されます。MAIN L/R出力にはMain DSPが選択されます。サブメニューでPRO LOGIC I、II (Movie)を選択可能です。常時Auto Input Balance offです。

AAC入力時はCS49329でデコード後、L/Rはプロロジック処理されます。(J modelのみ)

Dolby Digital Multi入力時は、通常のDolby Digital Normalと同じ動作をします。PRO LOGIC I、IIデコード時は、LFEは出力されません。

Dolby Pro Logic (Auto)

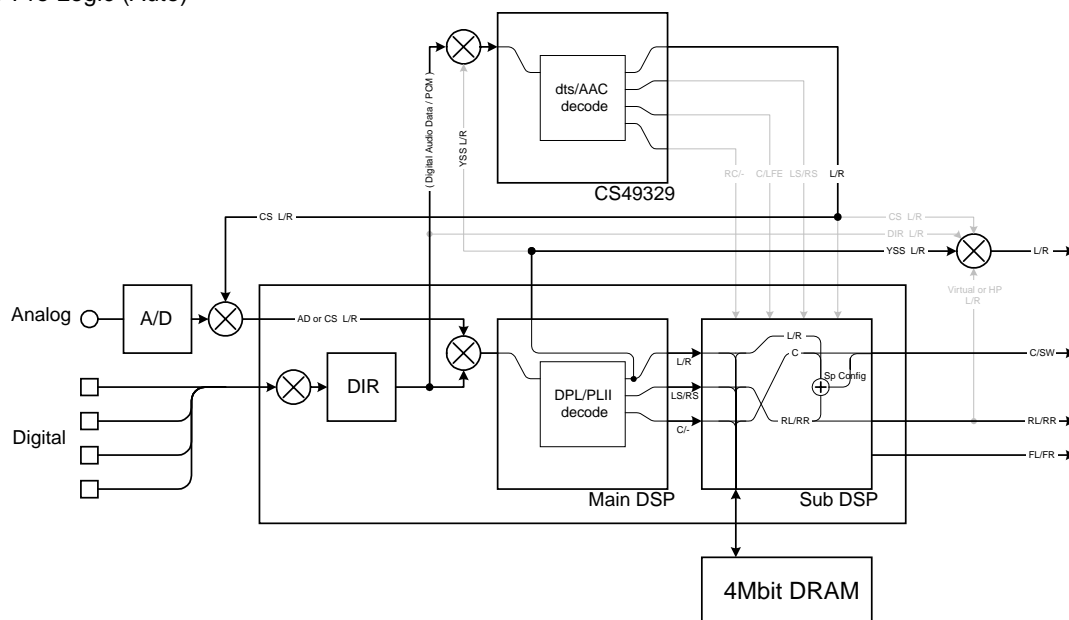

(Shaded items not used in this example)

Neo:6

(Not applied to these models.)

Neo:6

(このモデルには適用されません。)

3. Neo:6

4. SPEAKERS SET

The input signal is automatically identified and switched in the priority order of dts → DOLBY DIGITAL → AAC → PCM AUDIO → Analog (A/D) according to the signal detection.

The signals output from the DSP block are the same as 1.
DSP THROUGH: YSS 0dB.

4. SPEAKERS SET

入力は信号検出によって、dts → DOLBY DIGITAL → AAC → PCM AUDIO → アナログ(A/D)の優先順で自動判別切り換えされます。

DSP部からは、No.1 DSP THROUGHのYSS 0dBと同様の信号が出力されます。

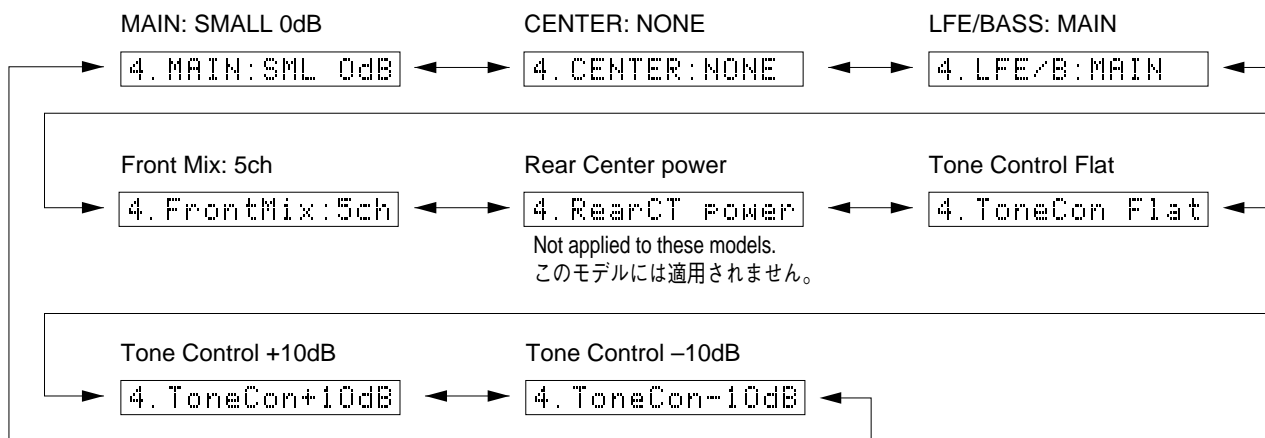

The analog switch settings for each sub-menu are as shown in the table below.

各サブメニューにおけるアナログスイッチの設定は以下の通りです。

Sub-menu		CENTER SP	REAR SP	MAIN SP	MAIN LEVEL	LFE/BASS
1	MAIN: SMALL 0dB	LARGE	LARGE	SMALL	0dB	SWFR
2	CENTER: NONE	NONE	LARGE	LARGE	0dB	BOTH
3	LFE/BASS: MAIN	SMALL	SMALL	LARGE	0dB	MAIN
4	FRONT MIX: 5CH	LARGE	LARGE	LARGE	0dB	BOTH
5	REAR CENTER: POWER (Not applied to these models. / このモデルには適用されません。)	LARGE	LARGE	LARGE	0dB	BOTH

LARGE: This mode is used with a speaker with high bass reproduction performance (a large unit). Full bandwidth signals are output.

SMALL: This mode is used with a speaker with low bass reproduction performance (a small unit). The signals of 90Hz or less are mixed into the channel specified by LFE/BASS.

NONE: This mode is used with no center speaker. The center content is reduced by 3dB and distributed to MAIN L/R.

LARGE : 低音再生能力の高い(ユニットの大きい)スピーカーを使用するモードです。全帯域が出力されます。

SMALL : 低音再生能力の低い(ユニットの小さい)スピーカーを使用するモードです。90Hz以下がLFE/BASSで指定したチャンネルにミックスされます。

NONE : スピーカーを使用しないモードです。センター成分は-3dBされて、MAIN L/R に振り分けられます。

Sub-menu		Treble	Bass
6	Tone Control Flat	0 dB	0 dB
7	Tone Control +10dB	+10 dB	+10 dB
8	Tone Control -10dB	-10 dB	-10 dB

Reference data

INPUT: DVD ANALOG (Both ch)

Sub-menu	Input level	Volume	SPEAKER OUTPUT (1kHz)			SUBWOOFER OUTPUT (50Hz)
			MAIN L/R	CENTER	RL/RR	
1 MAIN: SMALL 0dB	1kHz Both ch, -20 dBm	-10 dB	+10.8 dBm	- ∞	- ∞	- ∞
2 CENTER: NONE	1kHz Both ch, -20 dBm	-10 dB	+8.0 dBm	+10.8 dBm	- ∞	- ∞
3 LFE/BASS: MAIN	50Hz Both ch, -20 dBm	-10 dB	- ∞	- ∞	- ∞	+7.8 dBm
4 Front Mix: 5ch	1kHz Both ch, -20 dBm	-10 dB	+10.8 dBm	- ∞	- ∞	- ∞
5 Rear Center Power (Not applied to these models. /このモデルには適用されません。)	1kHz Both ch, -20 dBm	-10 dB	- ∞	- ∞	- ∞	- ∞
6 Tone Control Flat	1kHz Both ch, -20 dBm	-10 dB	+10.8 dBm	+10.8 dBm	+10.4 dBm	+0.8 dBm
7 Tone Control +10dB	1kHz Both ch, -20 dBm	-10 dB	+13.0 dBm	+10.8 dBm	+10.4 dBm	+0.8 dBm
8 Tone Control -10dB	1kHz Both ch, -20 dBm	-10 dB	+8.8 dBm	+10.8 dBm	+10.4 dBm	+0.8 dBm

5. MARGIN CHECK

The signal is output including the head margin.

MAIN 12dB MARGIN

Reference data

INPUT: DVD ANALOG

SWFR: 50Hz, Others: 1kHz

Input level	Volume	SPEAKER OUTPUT (1kHz)			SUBWOOFER OUTPUT (50Hz)
		MAIN L/R	CENTER	RL/RR	
Both ch, -20 dBm	-10 dB	+10.8 dBm	- ∞	- ∞	- ∞

MAIN 18dB MARGIN

Reference data

INPUT: DVD ANALOG

SWFR: 50Hz, Others: 1kHz

Input level	Volume	SPEAKER OUTPUT (1kHz)			SUBWOOFER OUTPUT (50Hz)
		MAIN L/R	CENTER	RL/RR	
Both ch, -20 dBm	-10 dB	+13.8 dBm	- ∞	- ∞	- ∞

5. MAIN 12dB

5. MAIN 18dB

5. MARGIN CHECK

ヘッドマージンを含んで出力されます。

MAIN 12dB MARGIN

MAIN 18dB MARGIN

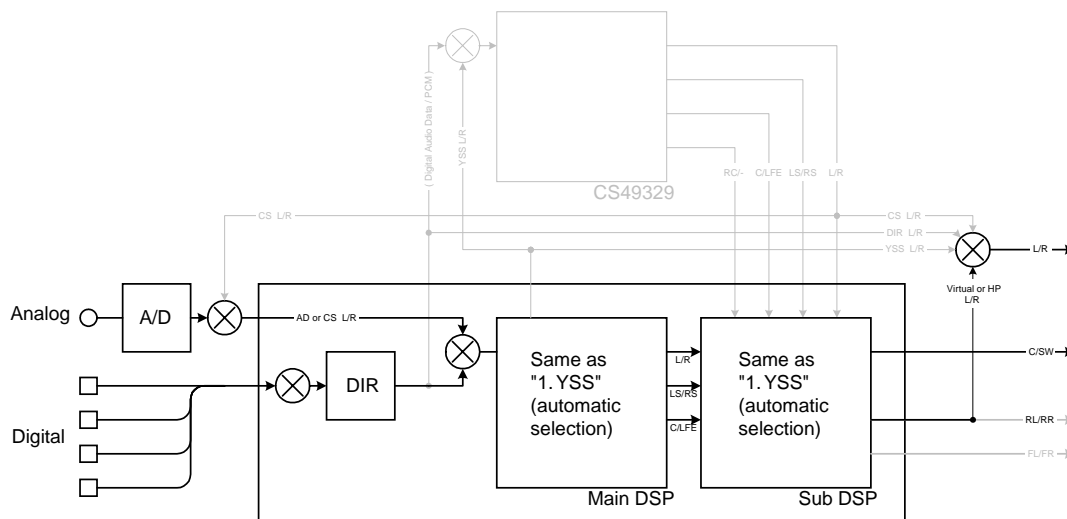

(Shaded items not used in this example)

6. OTHER INPUT

The signal input through the 6CH INPUT terminals is output.

6. OTHER INPUT

6CH入力した信号が出力されます。

EXTERNAL DECODER

EXTERNAL DECODER

6. EXTERNAL DEC

Reference data

INPUT: 6CH INPUT

SWFR: 50Hz, Others: 1kHz

Input level	Volume	SPEAKER OUTPUT (1kHz)			SUBWOOFER OUTPUT (50Hz)
		MAIN L/R	CENTER	RL/RR	
Both ch, -20 dBm	-10 dB	+10.8 dBm	+10.8 dBm	+10.8 dBm	-9.2 dBm

7. DISPLAY CHECK

This program is used to check the FL display section. The display condition varies as shown below according to the sub-menu operation. The signals are processed using EFFECT OFF (The L/R signal is output using ANALOG MAIN BYPASS.)

7. DISPLAY CHECK

FL表示部のチェックプログラムです。サブメニュー操作により、表示状態が以下のように変わります。

信号処理はEFFECT OFF (ANALOG MAIN BYPASSでL/Rを出力)です。

Regarding internal/external synchronization selection of the image signals by the microprocessor control, the internal synchronization is selected when the initial display is provided and when all FL's light up and the external synchronization at any other time.

マイコン制御による映像信号の内部/外部同期切替は、初期表示とFL 全点灯時に内部同期となり、それ以外は強制外部同期となります。

Also, except when the initial display is provided, 128 characters for confirmation of the OSD driver are displayed as the image output.

また、初期表示以外で映像出力にOSDドライバ確認用128文字表示が出ます。

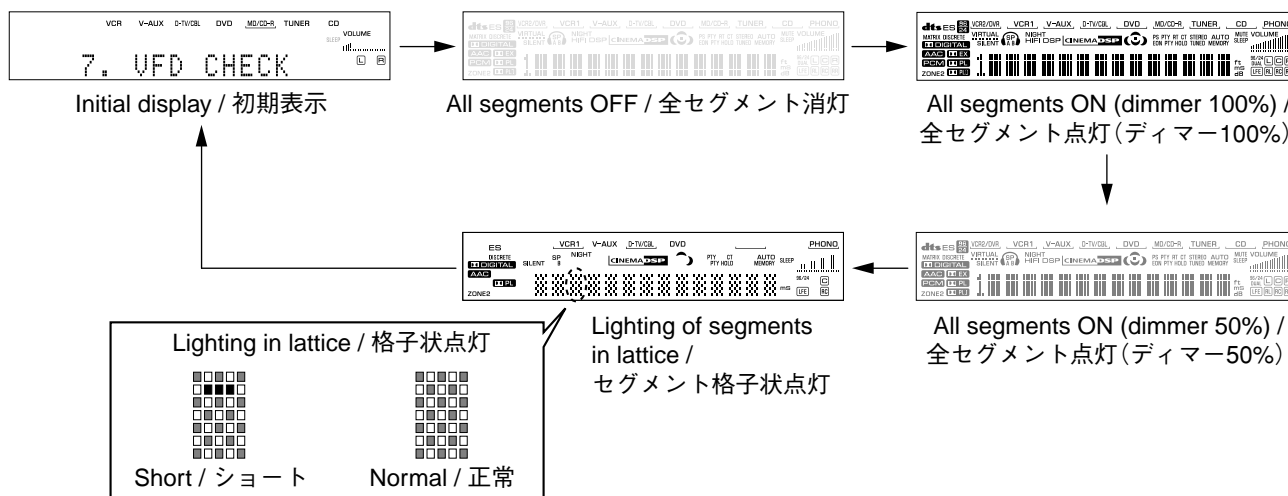

Segment conditions of the FL driver and the FL tube are checked by turning ON and OFF all segments. Next, the operation of the FL driver is checked by using the dimmer control. Then a short between segments next to each other is checked by turning ON and OFF all segments alternately (in lattice). (In the above example, the segments in the second row from the top are shorted.)

全セグメント消灯・全セグメント点灯によりFLドライバー、FL管のセグメントの不良を確認します。次に、ディマーコントロールによってFLドライバーの動作チェックを行います。さらに全セグメントを交互(格子状)に点灯/消灯することで、隣り合うセグメントのショートをチェックします。

8. MANUAL TEST

The noise generator built into the DSP outputs the test noise through the channels specified by the sub-menu. The noise frequency for LFE is 35 to 250 Hz. Other than that, the center frequency is 800Hz.

8. MANUAL TEST

DSP内蔵のノイズ発生回路によって、サブメニューで指定したチャンネルへテストノイズを出力します。LFE用のノイズ周波数は35～250Hz、それ以外は中心周波数800Hzとなります。

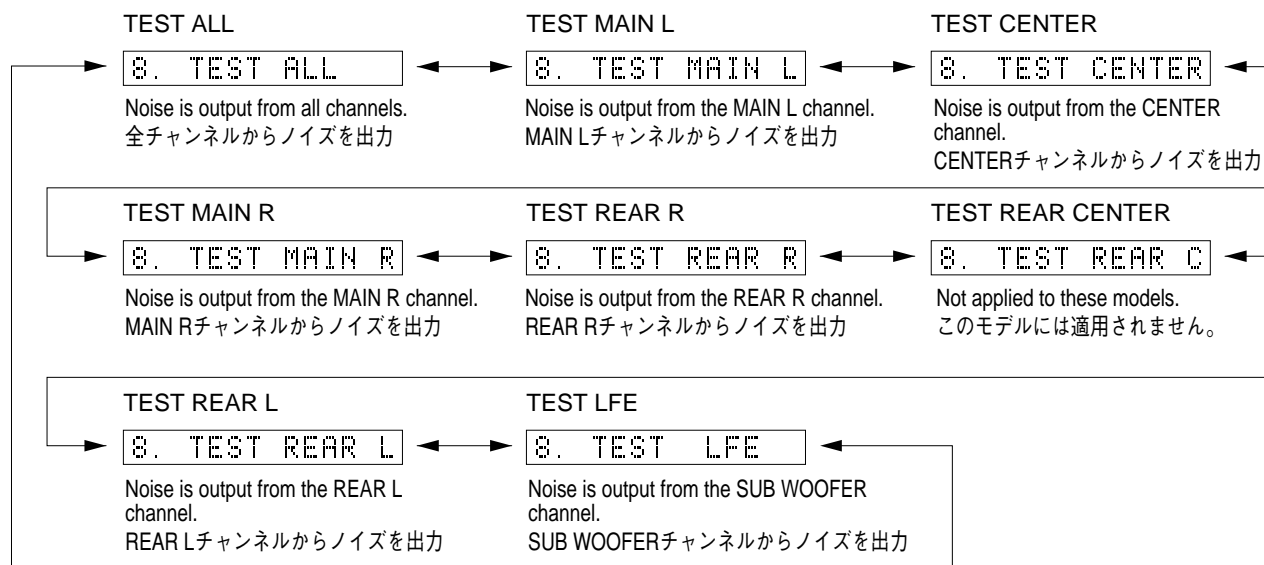

9. FACTORY PRESET

This menu is used to reserve and inhibit initialization of the back-up RAM. The signals are processed using EFFECT OFF. (The L/R signal is output using ANALOG MAIN BYPASS.)

9. FACTORY PRESET

バックアップ用RAM（音場プログラムのパラメーターやセットメニュー内容等）の初期化を予約/禁止します。信号処理はEFFECT OFFと同じです（ANALOG MAIN BYPASSで、L/Rを出力）。

9. PRESET INHI

PRESET INHIBIT (Initialization inhibited) / **PRESET INHIBIT** (初期化禁止)

RAM initialization is not executed. Select this sub-menu to protect the values set by the user. RAMの初期化は行われません。ユーザーの設定値を保護するときは、こちらを選択してください。

9. PRESET RSRV

PRESET RESERVED (Initialization reserved) / **PRESET RESERVED** (初期化予約)

Initialization of the back-up RAM is reserved. (Actually, initialization is executed the next time that the power is turned on.) Select this sub-menu to reset to the original factory settings or to reset the RAM.

バックアップRAMの初期化が予約されます。（実際に初期化されるのは、次回の電源投入時です。）工場出荷時やRAMをリセットしたいときは、こちらを選択してください。

CAUTION: Before setting to the PRESET RESERVED, write down the existing preset memory content of the Tuner in a table as shown below. (This is because setting to the PRESET RESERVED will cause the user memory content to be erased.)

注意：PRESET RESERVEDを選んで初期化をする前に、チューナーのユーザーメモリー内容を下表に書き写してください。（初期化をすると、ユーザーメモリーの内容は消えてしまいます。）

Preset group	P1	P2	P3	P4	P5	P6	P7	P8
A								
B								
C								
D								
E								

• PRESET STATIONS / プリセット局

STATION		FM FACTORY PRESET DATA (MHz)		
PAGE	NO.	U, C	R, T, K, A, B, G, L	J
A/C/E	1	87.5	87.5	76.0
	2	90.1	90.1	83.0
	3	95.1	95.1	84.0
	4	98.1	98.1	86.0
	5	107.9	108.0	90.0
	6	88.1	88.1	78.0
	7	106.1	106.1	88.0
	8	107.9	108.0	82.1

STATION		AM FACTORY PRESET DATA (kHz)		
PAGE	NO.	U, C, R, T, K	A, B, G, L	J
B/D	1	630	630	630
	2	1080	1080	1080
	3	1440	1440	1440
	4	530	531	531
	5	1710	1611	1611
	6	900	900	900
	7	1350	1350	1350
	8	1400	1404	1404

10. AD DATA CHECK/FAN TEST

This menu is used to display the A/D conversion value of the terminals which detects panel keys of the main unit and protection functions in % using the sub-menu. During signal processing, the condition before execution is maintained.

When K0/K1 menu is selected, keys become non-operable due to detection of the values of all keys. However, it is possible to advance to the next sub-menu by turning the VOLUME of the main unit. When using this function, note that turning the VOLUME more than 2 clicks will cause the volume value to change.

* The figures in the diagram are given as reference only.

DC/PS (protection detection)

DC: DC protection value (Normal value: 7 to 100)

If DC is out of the normal value range, the protection function works to turn off the power.

PS: Power supply voltage protection value (Normal value: 28 to 47)

If PS is out of the normal value range, the protection function works to turn off the power.

DC: 98%PS: 38%

THM/Fan (temperature detection/fan drive level)

THM: 500% display of the voltage based on the temperature detected value. Reference voltage : 5V (Normal value: 30 to 147)

Fan: Current fan drive level on the left and the past fan drive history on the right.
(Not applied to these models.)

THM 98%5Fan_/_/...

REC-OUT

Not applied to these models.

REC-OUT:

10. AD DATA CHECK/FAN TEST

本体パネルキー、プロテクションなどを検出している端子のA/D変換の値を、サブメニューで%表示します。信号処理は実行前の状態を維持します。

K0/K1のメニューにすると、全キーの値を検出するためキー操作はできなくなりますが、本体のVOLUMEを回すことにより、次のサブメニューに進めることができます。このとき2クリック以上回すと、ボリューム値が変化するので注意してください。

※図中の数値は参考例です。

DC/PS (プロテクションの検出)

DC: DCプロテクションの値(正常値7~100)

DCは正常値を外れるとプロテクションが働き、電源オフされます。

PS: 電源電圧プロテクションの値(正常値28~47)

PSは正常値を外れるとプロテクションが働き、電源オフされます。

THM/Fan (温度検出/ファン駆動レベル)

THM: 温度検出値で電圧の500%表示、基準電圧は5V (正常値30~147)

Fan: 左側は現在のファン駆動レベル、右側は過去のファン駆動履歴
(このモデルには適用されません。)

REC-OUT

このモデルには適用されません。

IMP SW/POWER LIMIT (Impedance/power limiter detection)

IMP: 8 or 4 ohm impedance switch setting
(Not applied to these models.)

PL: Power limiter detection value

The voltage value of pin No. 91 of IC472 is displayed, using 5V/256 as standard.

The port output is controlled by using the input voltage value of pin No. 91 of IC472.

When higher than VthH, the port output is changed from H to L.

When lower than VthL, the port output is changed from L to H.

IMP SW/POWER LIMIT (インピーダンス/パワーリミッターの検出)

IMP: インピーダンスSW検出の値
(このモデルには適用されません。)

PL: パワーリミッター検出の値

IC472 91ピンの電圧値を5V/256を基準にして表示します。

IC472 91ピンの入力電圧値により、ポート出力を制御します。

VthHを越えた場合、ポート出力をHからLにします。

VthLを下回った場合、ポート出力をLからHにします。

Note:

Vth = Threshold voltage

PORT	VthL	VthH	
No.87	2.48V	3.08V	U, C, J models
	2.70V	3.30V	A, B, G, R, T, K models

IMP:8 PL:55%

なお、出力が無い状態ではIC472 91ピンの入力電圧は約4.9Vです。

K0/K1 (Panel key of main unit)

A/D of the key fails to function properly when the standard value is deviated. In this case, check the constant of partial pressure resistor, solder condition, etc. Refer to table 1.

K0/K1 (本体パネルキー)

キーのA/Dは基準値から外れると、正常な動きをしません。Table 1をご覧ください。各キーの分圧抵抗の定数、ハンダ不良等の確認をしてください。

K0:100%K1:100%

[Table 1]

Display (%)	K0	K1
0 - 6	INPUT SELECT LEFT	INPUT MODE
7 - 13	INPUT SELECT RIGHT	6CH INPUT
14 - 21	STEREO	EDIT PRESET
22 - 31	◁ PROGRAM	FM/AM
32 - 41	PROGRAM ▷	TUNING MODE
42 - 53	PRESET PAGE	MEMORY
54 - 63	◁ PRESET/TUNING	PTY SEEK MODE
64 - 72	PRESET/TUNING ▷	PTY SEEK START
73 - 80	TONE SELECT	EON
81 - 88	TONE DOWN	RDS MODE
89 - 95	TONE UP	-

FAN DRIVE TEST (For models so equipped)

HIGH (Not applied to these models.)

FAN TEST:HIGH

FAN DRIVE TEST (ファン駆動テスト)

HIGH: ファン駆動強(このモデルには適用されません。)

FAN DRIVE TEST (For models so equipped)

MID (Not applied to these models.)

FAN TEST:MID

FAN DRIVE TEST (ファン駆動テスト)

MID: ファン駆動中(このモデルには適用されません。)

FAN DRIVE TEST (For models so equipped)

LOW (Not applied to these models.)

FAN TEST:LOW

FAN DRIVE TEST (ファン駆動テスト)

LOW: ファン駆動弱(このモデルには適用されません。)

11. IF STATUS (Input function status)

Using the sub-menu, the status data is displayed one after another in the hexadecimal notation.

During signal processing, the status before execution of this menu is maintained.

* Numeric values in the figure example are for reference.

IS1, 2 (Internal status):

Indicates the status information of the microprocessor.

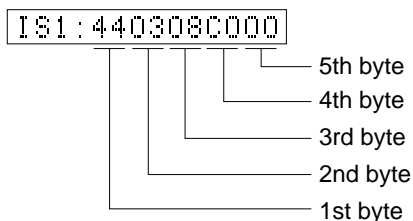

<1st byte> Digital input/output setting value
Upper 4 bits: REC OUT selected /
lower 4 bits: INPUT selected

11. IF STATUS

サブメニュー操作により、以下のステータス情報を順次16進数で表示します。信号処理は、本メニュー実行前の状態を維持します。

※図中の数値は参考例です。

IS 1, 2 (内部ステータス):

マイコンのステータス情報を表示します。

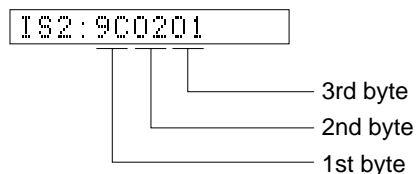

<第1バイト> デジタル入出力設定値
上位4bit REC OUT選択 /
下位4bit INPUT選択

Value	Choice	Preset name
0	NONE	
1	OPTA	V-AUX
2	OPTB	MD/CD-R
3	OPTC	DVD
4	OPTD	D-TV/CBL
8	COAXA	CD

<2nd byte> Fs information of reproduction signal

<第2バイト> 再生信号のFs情報

Display	00	01	02	03	04	05	06	0A	0B	0C	0D
Fs (kHz)	Analog	32	44.1	48	64	88.2	96	Unknown NRM	Unknown DBL	Unknown QUAD	Not defined

<3rd byte> Audio code mode information of reproduction signal

<第3バイト> 再生信号のオーディオコードモード情報

Display	00	01	02	03	04	05	06	07	08	09	0A	0B	0C	0D
Audio Code	1+1	1/0	2/0	3/0	2/1	3/1	2/2	3/2	2/3	3/3	OVER 6.1	MULTI MONO	MULTI PCE	Unknown

<4th byte> Format information of reproduction signal

<第4バイト> 再生信号のフォーマット情報

*1: Analog processing used for digital reproduction is not possible because of a commercial bit or 4-ch audio reason.

*1: 業務用ビットや4chオーディオなどの理由で、デジタル再生できずアナログ処理されます。

Display	Signal format
00	Analog (Unlock)
01	Incorrect digital (*1)
10	PCM Audio
20	Digital Data
21	IEC1937 Data
22	None PCM
23	Unknown
50	dts
51	Red dts
54	dts-ES MATRIX
58	dts-ES DISCRETE
5C	dts-ES (Both flag)
60	AAC
C0	Dolby Digital
C1	D.D. Karaoke
C4	D.D.6.1 (D.D.EX)

<5th byte> Signal processing status information
 *2: With digital signals other than 32kHz, 44.1kHz and 48kHz, through processing method is used for reproducible signals.

<第5バイト>信号処理ステータス情報
 *2: 32kHz、44.1kHz、48kHz以外のデジタル信号の場合、再生可能な信号についてはスルー処理されます。

bit7	MUTE request	bit3	-
bit6	Red dts flashing	bit2	Through & bypass (*2)
bit5	6.1/EX processing	bit1	-
bit4	FULL MUTE (ON: 1)	bit0	dts analog mute

CS1-5: Indicates channel status information of the input signal (IEC60958).

CS 1-5: 入力信号のIEC60958チャンネルステータス情報を表示します。

CS1:0299000200 ----- CS5:00000000

BY1-4: Indicates information of the bit stream included in the DOLBY DIGITAL signal.

BY1-4: DOLBY DIGITAL信号に含まれるビットストリームインフォメーション情報を表示します。

BY1:1E40E1301B ----- BY4:01FFFFFF

BS1-5: Indicates information of the bit stream included in the dts signal.

BS1-5: dts信号に含まれるビットストリームインフォメーション情報を表示します。

BS1:000070FFFF ----- BS5:C4

YS1-3: Indicates device status information of YSS938 (IC601).
 * The numeric value in the figure is an example for reference.

YS1-3: YSS938 (IC601)のデバイスステータス情報を表示します
 ※ 図中数値は参考例です。

YS1:FED2004F97

YS2:0101418000

YS3:1A41803D

Byte No.	Function
1	YSS MUTE Reg
2	YSS MODE Reg
3	YSS IPORT BIT 7-0
4	YSS IPORT BIT 14-8
5	YSS OPORT

Byte No.	Function
1	IEC 1937 Preamble Pc
2	Data Stream Reg
3	Status Reg
4	YSS ZERO Reg
5	MIREG

Byte No.	Function
1	DIR Status
2	DIR fs
3	DIR fs count
4	YSS ZEROBF

SD: CS49329 Unsolicited Messages (AUTODETECT_RESPONSE)

SD: CS49329 Unsolicited Messages (AUTODETECT_RESPONSE)

SD :000001

MTT: Mute Trigger

MTT: Mute Trigger

MTT:0020000007

Byte No.	Function
1	Mute condition
2	Factor of the last mute
3	Error count of YSS938-FSCNT
4	Mute count by YSS938-FSCNT
5	Error factor of down load of CS49329

12. DSP RAM CHECK

This menu is used to self-diagnose whether or not the bus connection for the YSS938 and the external RAM is made properly.

During signal processing, the status before execution of this menu is maintained.

The address bus and the data bus are checked and the connection condition is displayed.

When no error is detected, "NoEr" appears on display.

YSS938 Bus Check

```
YSS  BUS:NoEr
```

Display	Description
WAIT	Bus is being checked.
NoEr	No error detected.
DATA	Data bus shorted or open.
RSCS	/RAS or /CAS shorted, or open.
ADDR	Address bus shorted or open.

PLD/SRAM BUS CHECK

```
SD  BUS:None
```

Display	Description
WAIT	Bus is being checked.
None	No error detected.
EDxx	Data bus shorted or open. (XX: 00-07)
EAXx	Address bus shorted or open. (XX: 00-0E)

13. SD DL CODE

This menu is used to display the data version of the FLASH ROM, TOC information and sum calculated value for the second decoder.

RDV

Displays the data version.

```
RDV:XXXXXXXX
```

TA 0-5

Displays the TOC information.

```
TA0:0502629A  -----  TA5:FFFFFFFF
```

SA 0-5

Displays the sum calculated value.

```
SA0:984E984E  -----  SA5:FFFFFFFF
```

12. DSP RAM CHECK

YSS938と外付けRAMとのバス接続の正否を自己診断します。

信号処理は、このメニューを実行する前の状態を維持します。

アドレスバス、データバスのチェックを行い、接続正否を表示します。

エラーが検出されなかった場合は、“NoEr”と表示されません。

YSS938 BUS CHECK

PLD/SRAM BUS CHECK

13. SD DL CODE

2ndデコーダ用FLASH ROMのデータバージョン、TOC情報およびサム算出値を表示します。

RDV

データバージョンを表示します。

TA 0-5

TOC情報を表示します。

SA 0-5

サム算出値を表示します。

14. SOFT SW

This menu is used to switch the function settings on P.C.B. through the software so as to activate the product.

The protection function follows the P.C.B. settings. When connected to AC or in the maker preset state, the unit is initialized to the P.C. B. setting. Display of each function after initialization varies depending on settings on P.C.B. The operation mode can be changed by selecting the sub-menu and then using the EFFECT key. With SOF selected for the SW mode, the settings become effective.

SW MODE: PCB or SOFT can be selected.

14. SW : PCB

MODEL SETTING: V340 or V340T can be selected.

14. MODEL: V340

TUNER DESTINATION: J, UC, ALG or R can be selected.

14. DEST : UC

TUNER: NOT or EXIST can be selected.

14. TUNER: NOT

RDS: NOT or EXIST can be selected.

14. RDS : NOT

ZONE2: NOT or EXIST can be selected.

14. ZONE2: NOT

VIDEO FORMAT: NTSC or PAL can be selected.
(J model only)

14. VIDED: PAL

14. SOFT SW

P.C.B.上の機能設定をソフト的に切り替えて、製品を動作させる機能です。

プロテクション機能は、P.C.B.の設定に従います。AC接続またはメーカープリセットで、P.C.B.の設定に初期化されます。初期化後の各機能の表示は、P.C.B.上の設定によります。操作は、サブメニューを選んだ後、EFFECTキーで切り替えます。SWモードをSOFTにすると、設定が有効になります。

SW MODE : PCBまたはSOFTを選択できます。

MODEL SETTING : V340、V340Tのいずれかを選択できます。

TUNER DESTINATION : J、UC、ALG、Rのいずれかを選択できます。

TUNER : NOTまたはEXISTを選択できます。

RDS : NOTまたはEXISTを選択できます。

ZONE2 : NOTまたはEXISTを選択できます。

VIDEO FORMAT : NTSCまたはPALを選択できます。
(Jモデルのみに適用)

15. MICROPROCESSOR INFORMATION

The version, checksum and the port specified by the microprocessor are displayed. The signal is processed using EFFECT OFF. The checksum is obtained by adding the data at every 8 bits for each program area and expressing the result as a 4-figure hexadecimal data.

15. マイコン情報

サブメニューは4つあります。プログラムのバージョン、チェックサム、マイコンの指定ポートを表示します。信号はエフェクトOFFです。チェックサムは、プログラムエリア別にデータを8ビットごとに加算していき、4桁の16進データで現したものです。

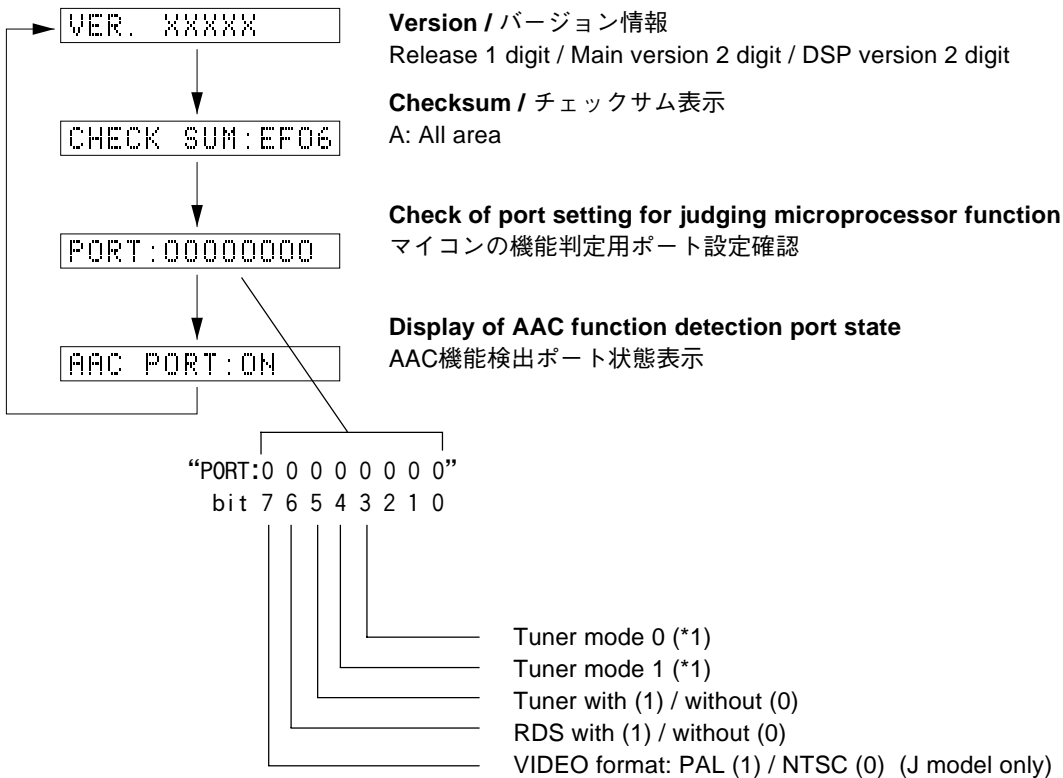

*1

Type	Tuner mode		Port 3 (type 2)	Frequency range	
	1	0		FM	AM
0	0	0	-	76.0-90.0MHz / 100kHz	531-1611kHz / 9kHz
1	1	0	-	87.5-108.0MHz / 50kHz	531-1611kHz / 9kHz
2	0	1	-	87.5-107.9MHz / 200kHz	530-1710kHz / 10kHz
3	1	1	Low	87.5-108.0MHz / 100kHz	530-1710kHz / 10kHz
			High	87.5-108.0MHz / 50kHz	531-1611kHz / 9kHz

■ CONFIRMATION OF IDLING CURRENT / アイドリング電流の確認

Confirmation of Idling Current of Main (1) P. C. B.

- Right after power is turned on, confirm that the voltage across the terminals of R359 (Main Lch), R360 (Main Rch), R350 (Center), R358 (Rear Lch), R361 (Rear Rch) are between 0.1mV and 10.0mV.

メイン(1)基板のアイドリング電流の確認

- 電源投入直後、R359 (MAIN Lch)、R360 (MAIN Rch)、R350 (CENTER)、R358 (REAR Lch)、R361 (REAR Rch)の端子間電圧を測定し、0.1mVから10.0mVの間であることを確認してください。

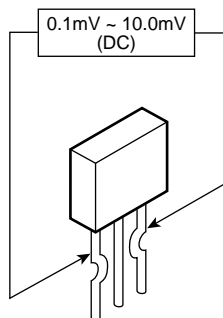

R359 (MAIN Lch)
R360 (MAIN Rch)
R350 (CENTER)
R358 (REAR Lch)
R361 (REAR Rch)

Note:

Before the confirmation, remove the FUNCTION (4) P.C.B. and connect the G651 of the FUNCTION (4) P.C.B. to the chassis with a jumper wire or the like.

注意:

確認の前にFUNCTION(4)P.C.B.を取り外し、FUNCTION(4) P.C.B.のG651とシャーシをリード線等で接続してください。

■ DISPLAY DATA

● V581 : HNA-16MM43 (WA531200)

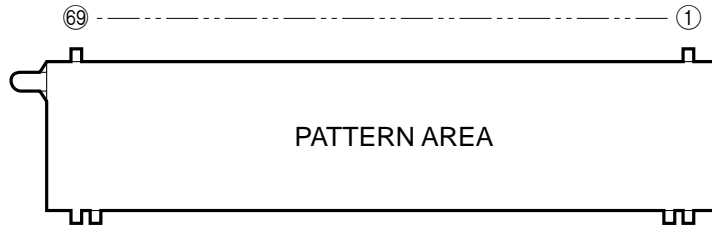

● PIN CONNECTION

Pin No.	69	68	67	66	65	64	63	62	61	60	59	58	57	56	55	54	53	52	51	50	49	48	47	46	45	44	43	42	41	40	39	38	37	36	35
Connection	F2	F2	NP	NP	P1	P2	P3	P4	P5	P6	P7	P8	P9	P10	P11	P12	P13	P14	P15	P16	P17	P18	P19	P20	P21	P22	P23	P24	P25	P26	P27	P28	P29	P30	P31

Pin No.	34	33	32	31	30	29	28	27	26	25	24	23	22	21	20	19	18	17	16	15	14	13	12	11	10	9	8	7	6	5	4	3	2	1
Connection	P32	P33	P34	P35	P36	P37	P38	NX	NX	NX	NX	NX	NX	NX	16G	15G	14G	13G	12G	11G	10G	9G	8G	7G	6G	5G	4G	3G	2G	1G	NP	NP	F1	F1

Note : 1) F1, F2 Filament 2) NP No pin 3) G1 ~ 16 Grid 4) NX No extened 5) P1 ~ 38 Anode

● GRID ASSIGNMENT

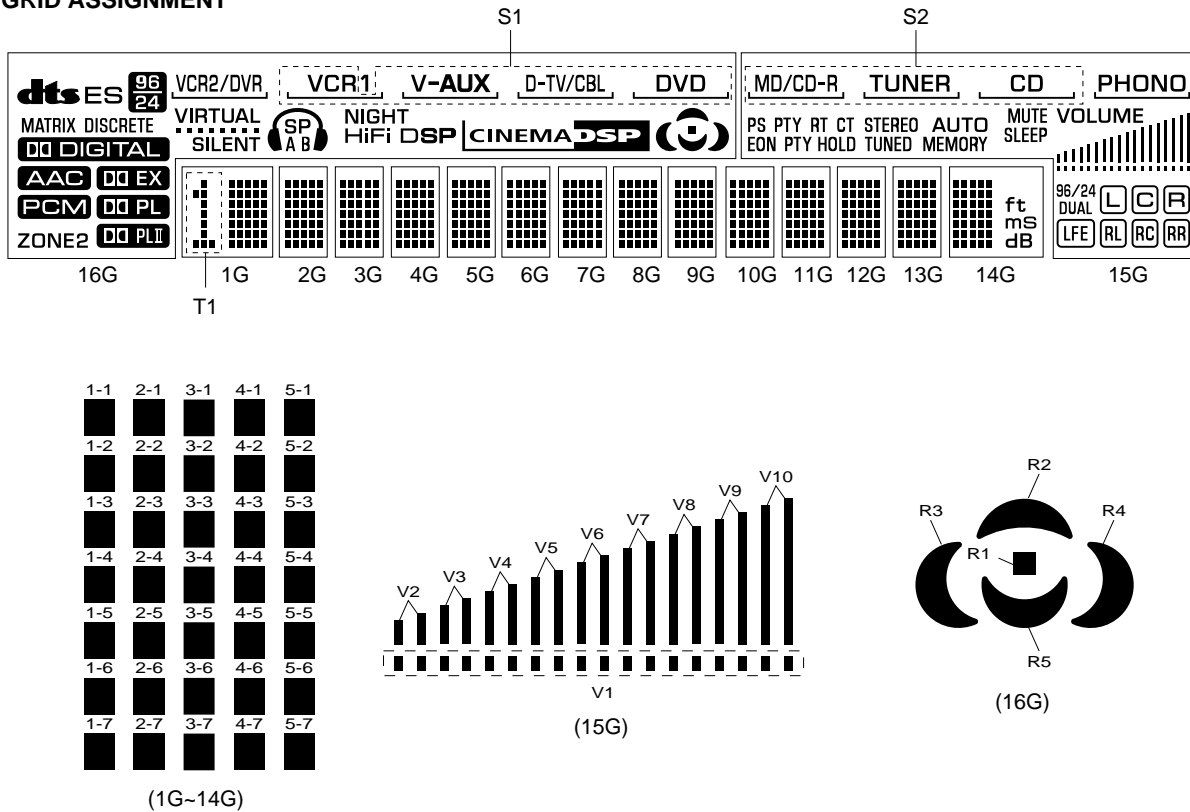

RX-V340/RX-V340RDS/HTR-5630/HTR-5630RDS/DSP-AX340

● ANODE CONNECTION

	16G	15G	14G	13G~2G	1G
P1	dts	S2	1-1	1-1	1-1
P2	ES	PHONO	2-1	2-1	2-1
P3	MATRIX	<u>(MD/CD-R)</u>	3-1	3-1	3-1
P4	DISCRETE	<u>(TUNER)</u>	4-1	4-1	4-1
P5	96/24	<u>(CD)</u>	5-1	5-1	5-1
P6	DD DIGITAL	<u>(PHONO)</u>	1-2	1-2	1-2
P7	DD EX	PS	2-2	2-2	2-2
P8	DD PL	PTY	3-2	3-2	3-2
P9	DD PLII	RT	4-2	4-2	4-2
P10	AAC	CT	5-2	5-2	5-2
P11	PCM	EON	1-3	1-3	1-3
P12	ZONE2	PTY HOLD	2-3	2-3	2-3
P13	VIRTUAL	STEREO	3-3	3-3	3-3
P14	SILENT	AUTO	4-3	4-3	4-3
P15		TUNED	5-3	5-3	5-3
P16	SP	MEMORY	1-4	1-4	1-4
P17	A	MUTE	2-4	2-4	2-4
P18	B	SLEEP	3-4	3-4	3-4
P19	HiFi DSP	VOLUME	4-4	4-4	4-4
P20	CINEMA DSP	V1	5-4	5-4	5-4
P21	R1	V2	1-5	1-5	1-5
P22	R2	V3	2-5	2-5	2-5
P23	R3	V4	3-5	3-5	3-5
P24	R4	V5	4-5	4-5	4-5
P25	R5	V6	5-5	5-5	5-5
P26	S1	V7	1-6	1-6	1-6
P27	<u>VCR2/DVR</u>	V8	2-6	2-6	2-6
P28	<u>(VCR) 1</u>	V9	3-6	3-6	3-6
P29	<u>(VCR2/DVR)</u>	V10	4-6	4-6	4-6
P30	<u>(VCR1)</u>	96/24	5-6	5-6	5-6
P31	<u>(V-AUX)</u>	DUAL	1-7	1-7	1-7
P32	<u>(D-TV/CBL)</u>	LFE	2-7	2-7	2-7
P33	<u>(DVD)</u>	L	3-7	3-7	3-7
P34	NIGHT	C	4-7	4-7	4-7
P35	–	R	5-7	5-7	5-7
P36	–	RL	ft	–	T1
P37	–	RC	ms	–	–
P38	–	RR	dB	–	–

IC DATA

IC472: M3062VMGP (MAIN P.C.B.)

16bit μ -COM (Main CPU)

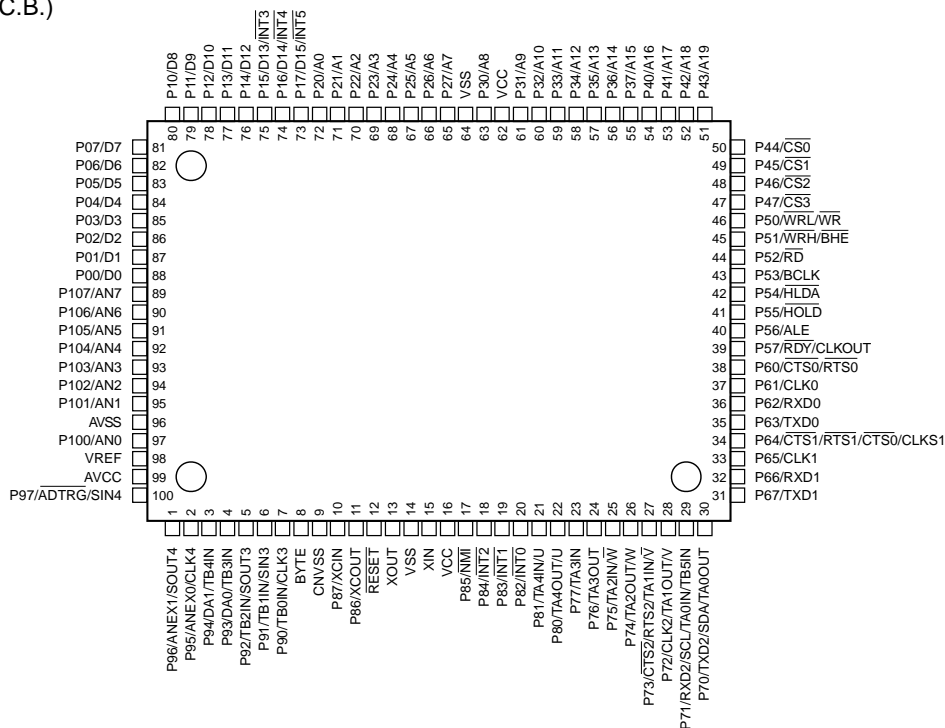

No.	Port No.	Function name	I/O	Detail of function
1	SOUT4	DTFD	SO	FL Driver TxD
2	CLK4	CKFD	SCK	FL Driver CLOCK
3	P94	/BLK	O	FL Driver OFF
4	P93		O	Open
5	SOUT3	SDM	SO	YSS938 TxD
6	SIN3	SDD	SI	YSS938 RxD
7	CLK3	YSSCK	SCK	YSS938 CLOCK
8	BYTE	YSS	VSS	Vss: when single chip mode is used
9	CNVss	CNVss	Vss/Vcc	Vss: when single chip mode is used, Vcc: when flash writing is used
10	P87	CSY	O	YSS938 CE
11	P86	/ICD	O	YSS938/DA/AD/CODEC/DEM
12	RESET	RESET	I	Reset
13	Xout	Xout		Oscillator Out
14	Vss	Vss	Vss	μ -COM Ground
15	Xin	Xin	16MHz	Oscillator in
16	Vcc	Vcc	Vcc (BU)	μ -COM power supply, +5V
17	NMI	NMI	Vcc (BU)	Connect to Vcc because it is unused.
18	INT2	INT938	INT	YSS928 IPINT/MUTE/DIR
19	INT1	PSW	INT	Standby SW Input
20	INT0	REM1	INT	Remote Control Input
21	P81		O	Open
22	P80		O	Open
23	P77	/HP	I (IPU)	Headphone Detect
24	P76	VRA	I (IPU)	Volume Rotary A
25	P75	VRB	I (IPU)	Volume Rotary B
26	P74	CSN	O	Chip Select for DAC
27	P73	/ICCDK	O	CODEC Reset
28	CLK2		SCK	Open
29	P71		O (External PU)	Open
30	TXD2		SO (External PU)	Open
31	TXD1	TXDF	FLASH	Flash ROM Serial Write Data Transmission
32	RXD1	RXDF	FLASH	Flash ROM Serial Write Data Reception
33	CLK1	CLKF	FLASH	Flash ROM Serial Clock
34	P64	BSY	FLASH	Flash BUSY Signal Output
35	TXD0	CSR	SO	CS493x RxD
36	RXD0	CST	SI	CS493x TxD
37	CLK0	CSC	CLK	CS493x Clock
38	P60	/CEEEP	O	EEPROM CE
39	P57	SDTR	O	RDS/OSD TxD
40	P56	SDRR	SI/I (IPU)	RDS RxD / Frequency SW (Dest R)
41		/EMP	GND	For Flash Writing (LO)
42	P54	SCKR	SCK	RDS/OSD Clock
43	P53	/CSCS	O	CS493x CS

RX-V340/RX-V340RDS/HTR-5630/HTR-5630RDS/DSP-AX340

IC472: M3062VMGP (MAIN P.C.B.)

16bit μ -COM (Main CPU)

No.	Port No.	Function name	I/O	Detail of function
44	P52	/ICCS	O	CS493x Reset
45	P51	/CSPLD	O	Digital External Control IC CE
46		/CE	I	For Flash Writing (HI)
47	P47	CSINT	I/O	CS-DSP INT/ABOOT
48	P46	/FMT	O	Mute Main/Rear
49	P45	/CMT	O	Mute Center
50	P44		O	Open
51	P43	/MTSW	O	Mute LFE
52	P42	/SWMIX	O	SW Mix
53	P41	/CTMIX	O	CT Mix
54	P40		O	Open
55	P37		O/I	Open
56	P36	HPF	O	HPF
57	P35		O	Open
58	P34	CKBD	O	Clock Line for BD38xx System Control
59	P33	DTBD	O	Data Line for BD38xx System Control
60	P32	VIA	O	Video Selector A
61	P31	VIB	O	Video Selector B
62	Vcc	Vcc	Vcc (BU)	μ -COM Power Supply, +5V
63	P30		O	Open
64	Vss	Vss	Vss	μ -COM Ground
65	P27	/VR1	O	Video Rec Out Selector 1
66	P26		O	Open
67	P25		O	Open
68	P24		O	Open
69	P23		O	Open
70	P22		O/I	Open
71	P21		O	Open
72	P20	RDSE	O/I	RDS Enble, RDS Present/Absent
73	P17	CEP/TUN1	O/I	PLL IC Enable/Destination Discriminate 1
74	INT4	PDET	INT	Power Down Detect INT
75	INT3		INT	Open
76	P14	SCKP/TUN0	O/I	PLL IC Clock/Destination Discriminate 0
77	P13	SDTP	O	PLL IC TxD
78	P12	SDRP	I (IPU)	PLL IC RxD
79	P11	TUNED	I (IPU)	Tuned
80	P10	/ST	I (IPU)	Tuner/ST
81	P07	TMT	O	Tuner Mute
82	P06	PRY	O	Power Relay Output
83	P05	ERY	O	Effect SP Relay Output
84	P04		O	Open
85	P03	MARY	O	Main A SP Relay Output
86	P02	PRI	I	Protection Excess Current Detect
87	P01	LIMA	O	Power Limiter A
88	P00		O	Open
89	AN7	MODEL	AD	Connection Discriminate
90	AN6	PRD	AD	Protection DC Detect
91	AN5	PREMT	AD	Power Limiter Detect
92	AN4	THM	AD	Temperature Detect
93	AN3		AD	Open
94	AN2	ADKEY0	AD	Key AD Input 0
95	AN1	ADKEY1	AD	Key AD Input 1
96	Avss	Avss	Vss	AD Ground
97	AN0	PRV	AD	Protection Power Supply Voltage Detect
98	Vref	Vref	(+5v)	AD Reference
99	Avcc	Avcc	Vcc (BU)	AD Power Supply
100	P97	CEFD	O	FL Driver CE

IC803 : YSS938 (DSP P.C.B.)
DSP

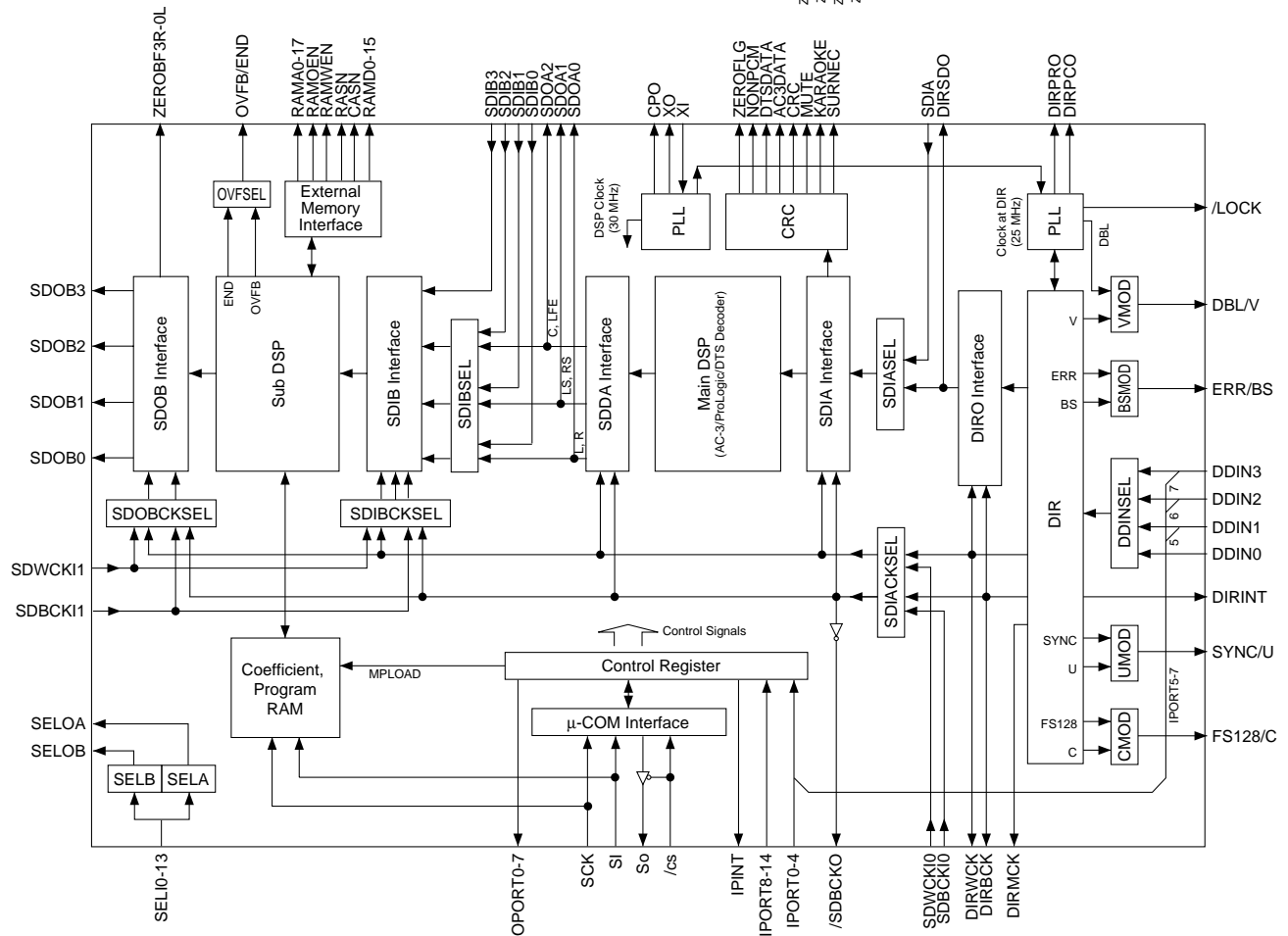
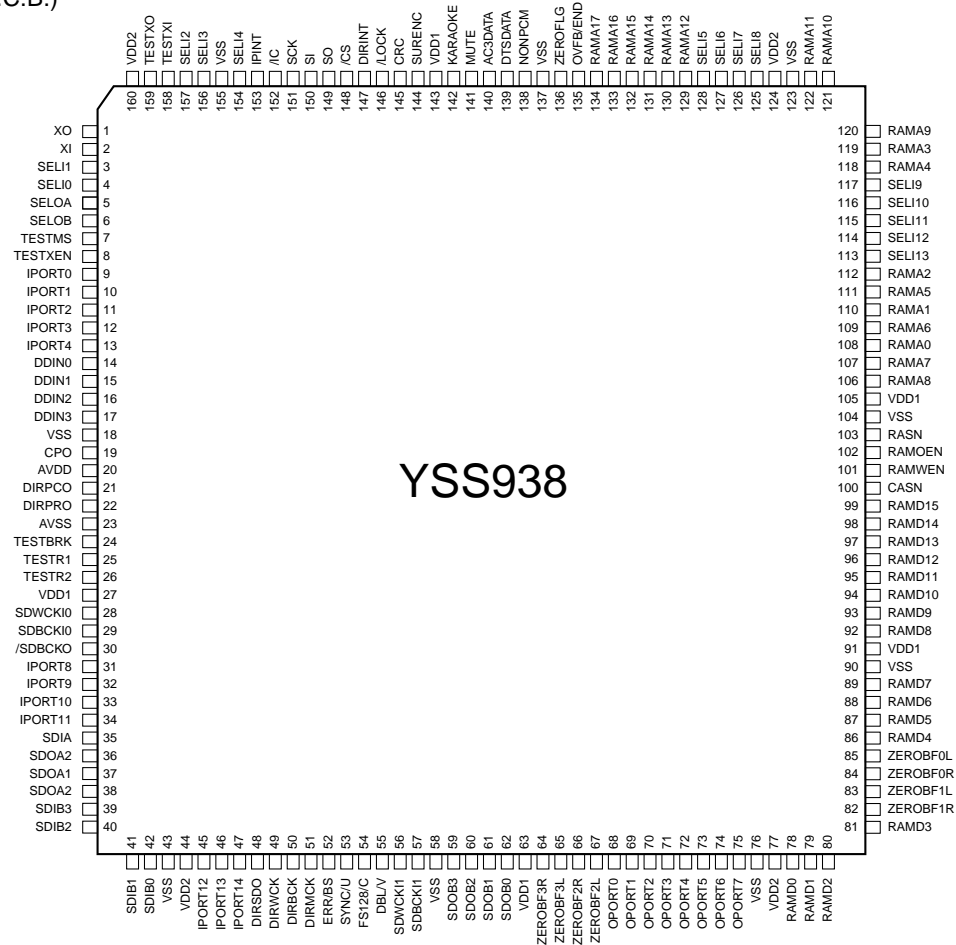

RX-V340/RX-V340RDS/HTR-5630/HTR-5630RDS/DSP-AX340

IC803 : YSS938 (DSP P.C.B.)

DSP

No.	Name	I/O	Function
1	XO	O	Crystal oscillator connecting terminal
2	XI	I	Crystal oscillator connecting terminal (24.576MHz)
3	SELI1	I+	Built-in selector input 1 (AXD)
4	SELI0	I+	Built-in selector input 0 (GND)
5	SELOA	O+	Built-in selector output A (ISEL)
6	SELOB	O+	Built-in selector output B (RSEL)
7	TESTMS	I+	Test terminal (unconnected)
8	TESTXEN	I+	Test terminal (unconnected)
9	IPOINT0	I+	General purpose input terminal (CXDTA)
10	IPOINT1	I+	General purpose input terminal (CXDTB)
11	IPOINT2	I+	General purpose input terminal
12	IPOINT3	I+	General purpose input terminal
13	IPOINT4	I+	General purpose input terminal
14	DDIN0	Is	DIR: Digital audio interface data input terminal 0 (ISEL)
15	DDIN1	Is	DIR: Digital audio interface data input terminal 1/General purpose input terminal (Pull down)
16	DDIN2	Is	DIR: Digital audio interface data input terminal 2/General purpose input terminal (Pull down)
17	DDIN3	Is	DIR: Digital audio interface data input terminal 3/General purpose input terminal (Pull down)
18	VSS		Ground terminal
19	CPO	A	PLL filter connecting terminal
20	AVDD		+3.3V power terminal (for DIR)
21	DIRPCO	A	DIR: PLL filter connecting terminal
22	DIRPRO	A	DIR: PLL filter connecting terminal
23	AVSS		Ground terminal (for DIR)
24	TESTBRK	I+	Test terminal (unconnected)
25	TESTR1	I+	PLL initialization signal input terminal for DSP (/ICD)
26	TESTR2	I+	Test terminal (unconnected)
27	VDD1		+3.3V power terminal (for terminal section)
28	SDWCKI0	I+	Word clock input terminal for SDIA, SDOA, SDIB, SDOB interface (WCKG)
29	SDBCKI0	I+	Bit clock input terminal for SDIA, SDOA, SDIB, SDOB interface (BCKG)
30	/SDBCK0	O	DIRBCK or SDBCKI0 invert clock output terminal (Unconnected)
31	IPOINT8	I+	IPINT general purpose input terminal
32	IPOINT9	I+	IPINT general purpose input terminal (NONPCM)
33	IPOINT10	I+	IPINT general purpose input terminal (NONPCM)
34	IPOINT11	I+	IPINT general purpose input terminal (MUTE)
35	SDIA	I	AC-3/DTS bit stream (or PCM) data input terminal to Main DSP (SDIA)
36	SDOA2	O	PCM output terminal from Main DSP (C/LFE output)
37	SDOA1	O	PCM output terminal from Main DSP (LS/RS output)
38	SDOA0	O	PCM output terminal from Main DSP (L/R output)
39	SDIB3	I+	PCM input terminal 3 to Sub DSP
40	SDIB2	I+	PCM input terminal 2 to Sub DSP
41	SDIB1	I+	PCM input terminal 1 to Sub DSP
42	SDIB0	I+	PCM input terminal 0 to Sub DSP
43	VSS		Ground terminal
44	VDD2		+2.5V power terminal (for internal circuit)
45	IPOINT12	I+	IPINT general purpose input terminal (DIRINT)
46	IPOINT13	I+	IPINT general purpose input terminal (DBL)
47	IPOINT14	I+	IPINT general purpose input terminal (DBL)
48	DIRSDO	O	AC-3/DTS bit stream (or PCM) data output terminal from DIR
49	DIRWCK	O	DIR: Serial data word clock (fs) output terminal (WCK)
50	DIRBCK	O	DIR: Serial data bit clock (64fs) output terminal (BCK)
51	DIRMCK	O	DIR: Serial data master clock (256fs or 128fs) output terminal (MCK)
52	ERR/BS	O	DIR: Data error detect output/block start output terminal (Unconnected)
53	SYNC/U	O	DIR: Serial data synchronous timing output/user data output terminal (Unconnected)
54	FS128/C	O	DIR: Serial data master clock 128fs output/channel status output terminal (FS128)
55	DBL/V	O	DIR: Double rate clock output/validity flag output terminal (DBL)

IC803 : YSS938 (DSP P.C.B.)

DSP

No.	Name	I/O	Function	
56	SDWCKI1	I+	Word clock input terminal for SDIB, SDOB interface	(WCKG)
57	SDBCKI1	I+	Bit clock input terminal for SDIB, SDOB interface	(BCKG)
58	VSS		Ground terminal	
59	SDOB3	O	PCM output terminal from Sub DSP	
60	SDOB2	O	PCM output terminal from Sub DSP	
61	SDOB1	O	PCM output terminal from Sub DSP	
62	SDOB0	O	PCM output terminal from Sub DSP	
63	VDD1		+3.3V power terminal (for terminal section)	
64	ZEROBF3R	O+	SDOB3 Rch zero flag output terminal	(ZF3R)
65	ZEROBF3L	O+	SDOB3 Lch zero flag output terminal	(ZF3L)
66	ZEROBF2R	O+	SDOB2 Rch zero flag output terminal	(ZF2R)
67	ZEROBF2L	O+	SDOB2 Lch zero flag output terminal	(ZF2L)
68	OPORT0	O	General purpose output terminal	(/RINH1)
69	OPORT1	O	General purpose output terminal	(/RINH2)
70	OPORT2	O	General purpose output terminal	(/ICDA)
71	OPORT3	O	General purpose output terminal	(/ICAD)
72	OPORT4	O	General purpose output terminal	(DPS)
73	OPORT5	O	General purpose output terminal	(RST)
74	OPORT6	O	General purpose output terminal	(ERROR)
75	OPORT7	O	General purpose output terminal	(/PRST)
76	VSS		Ground terminal	
77	VDD2		+2.5V power terminal (for internal circuit)	
78	RAMD0	I+/O	Sub DSP: External memory data terminal 0	
79	RAMD1	I+/O	Sub DSP: External memory data terminal 1	
80	RAMD2	I+/O	Sub DSP: External memory data terminal 2	
81	RAMD3	I+/O	Sub DSP: External memory data terminal 3	
82	ZEROBF1R	O+	SDOB1 Rch zero flag output terminal	(ZF1R)
83	ZEROBF1L	O+	SDOB1 Lch zero flag output terminal	(ZF1L)
84	ZEROBF0R	O+	SDOB0 Rch zero flag output terminal	(ZF0R)
85	ZEROBF0L	O+	SDOB0 Lch zero flag output terminal	(ZF0L)
86	RAMD4	I+/O	Sub DSP: External memory data terminal 4	
87	RAMD5	I+/O	Sub DSP: External memory data terminal 5	
88	RAMD6	I+/O	Sub DSP: External memory data terminal 6	
89	RAMD7	I+/O	Sub DSP: External memory data terminal 7	
90	VSS		Ground terminal	
91	VDD1		+3.3V power terminal (for terminal section)	
92	RAMD8	I+/O	Sub DSP: External memory data terminal 8	
93	RAMD9	I+/O	Sub DSP: External memory data terminal 9	
94	RAMD10	I+/O	Sub DSP: External memory data terminal 10	
95	RAMD11	I+/O	Sub DSP: External memory data terminal 11	
96	RAMD12	I+/O	Sub DSP: External memory data terminal 12	
97	RAMD13	I+/O	Sub DSP: External memory data terminal 13	
98	RAMD14	I+/O	Sub DSP: External memory data terminal 14	
99	RAMD15	I+/O	Sub DSP: External memory data terminal 15	
100	CASN	O	Sub DSP: Column address strobe output terminal for external DRAM	
101	RAMWEN	O	Sub DSP: Write enable terminal for external memory	
102	RAMOEN	O	Sub DSP: Output enable terminal for external memory	
103	RASN	O	Sub DSP: Low address strobe output terminal for external DRAM	
104	VSS		Ground terminal	
105	VDD1		+3.3V power terminal (for terminal section)	
106	RAMA8	O	Sub DSP: External memory address terminal 8	
107	RAMA7	O	Sub DSP: External memory address terminal 7	
108	RAMA0	O	Sub DSP: External memory address terminal 0	
109	RAMA6	O	Sub DSP: External memory address terminal 6	
110	RAMA1	O	Sub DSP: External memory address terminal 1	

IC803 : YSS938 (DSP P.C.B.)

DSP

No.	Name	I/O	Function
111	RAMA5	O	Sub DSP: External memory address terminal 5
112	RAMA2	O	Sub DSP: External memory address terminal 2
113	SELI13	I+	Built-in selector input 13 (Unconnected)
114	SELI12	I+	Built-in selector input 12
115	SELI11	I+	Built-in selector input 11 (Unconnected)
116	SELI10	I+	Built-in selector input 10 (Unconnected)
117	SELI9	I+	Built-in selector input 9 (CXB)
118	RAMA4	O	Sub DSP: External memory address terminal 4
119	RAMA3	O	Sub DSP: External memory address terminal 3
120	RAMA9	O	Sub DSP: External memory address terminal 9 (Unconnected)
121	RAMA10	O	Sub DSP: External memory address terminal 10 (Unconnected)
122	RAMA11	O	Sub DSP: External memory address terminal 11 (Unconnected)
123	VSS		Ground terminal
124	VDD2		+2.5V power terminal (for internal circuit)
125	SELI8	I+	Built-in selector input 8 (CXA)
126	SELI7	I+	Built-in selector input 7 (GND)
127	SELI6	I+	Built-in selector input 6 (OPTF)
128	SELI5	I+	Built-in selector input 5 (Unconnected)
129	RAMA12	O	Sub DSP: External memory address terminal 12 (Unconnected)
130	RAMA13	O	Sub DSP: External memory address terminal 13 (Unconnected)
131	RAMA14	O	Sub DSP: External memory address terminal 14 (Unconnected)
132	RAMA15	O	Sub DSP: External memory address terminal 15 (Unconnected)
133	RAMA16	O	Sub DSP: External memory address terminal 16 (Unconnected)
134	RAMA17	O	Sub DSP: External memory address terminal 17 (Unconnected)
135	OVFB/END	O	Sub DSP: Overflow/program end detect terminal (Unconnected)
136	ZEROFLG	O	Main DSP: Zero flag output terminal (Unconnected)
137	VSS		Ground terminal
138	NONPCM	O	Main DSP: Non-PCM data detect terminal
139	DTSDATA	O	Main DSP: DTS data detect terminal (Unconnected)
140	AC3DATA	O	Main DSP: AC3 data detect terminal (Unconnected)
141	MUTE	O	Main DSP: Auto mute detect terminal
142	KARAOKE	O	Main DSP: AC3 KARAOKE data detect terminal (Unconnected)
143	VDD1	+3.3V	power terminal (for terminal section)
144	SURENC	O	Main DSP: AC-3 2/0 mode Dolby surround encode input detect terminal (Unconnected)
145	CRC	O	Main DSP: AC3 CRC error detect terminal (Unconnected)
146	/LOCK	O	DIR: PLL lock detect terminal (Unconnected)
147	DIRINT	O	DIR: Interrupt output terminal
148	/CS	Is	Microprocessor interface chip select input terminal (/CSY)
149	SO	Ot	Microprocessor interface data output terminal (SDDY)
150	SI	Is	Microprocessor interface data input terminal (SDMYB)
151	SCK	Is	Microprocessor interface clock input terminal (SCKYB)
152	/IC	Is	Initial clear input terminal (/ICYP)
153	IPINT	O+	Interrupt output terminal by IPORT 8-14
154	SELI4	I+	Built-in selector input 4 (OPTD)
155	VSS		Ground terminal
156	SELI3	I+	Built-in selector input 3 (OPTC)
157	SELI2	I+	Built-in selector input 2 (OPTB)
158	TESTXI	I	Test terminal (should be always connected to VSS)
159	TESTXO	O	Test terminal (Unconnected)
160	VDD2	+2.5V	power terminal (for internal circuit)

Is: Schmidt trigger input terminal
I+: Input terminal with pull-up resistor
O: Digital output terminal
Ot: 3-state digital output terminal
A: Analog terminal

1 ■ PRINTED CIRCUIT BOARD (Foil side)

DSP P. C. B. (Lead Type Device)

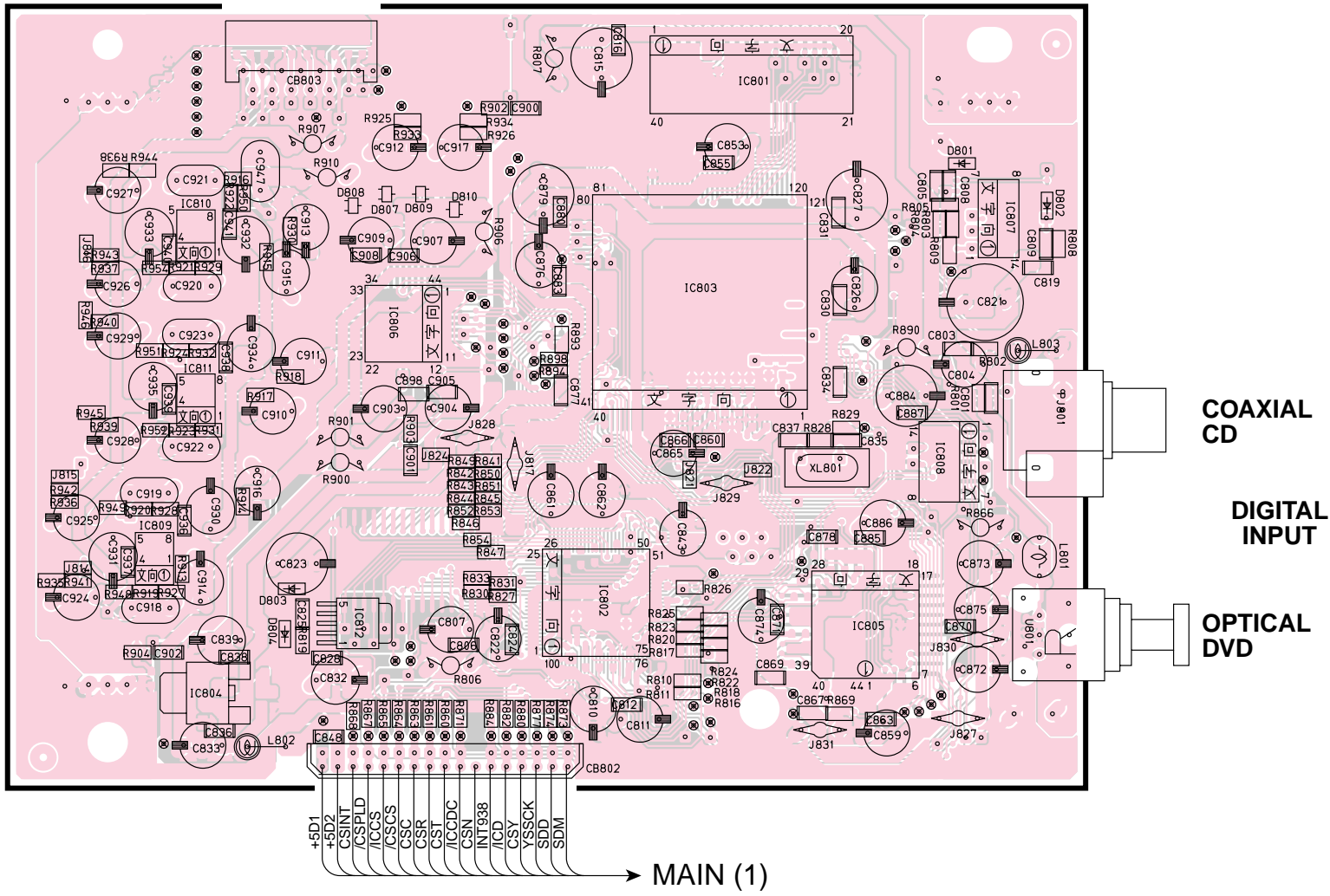
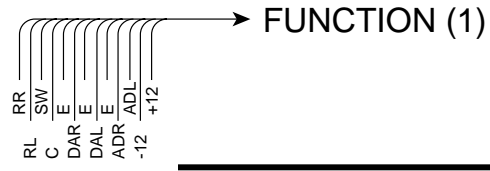

DSP P. C. B. (Surface Mount Device)

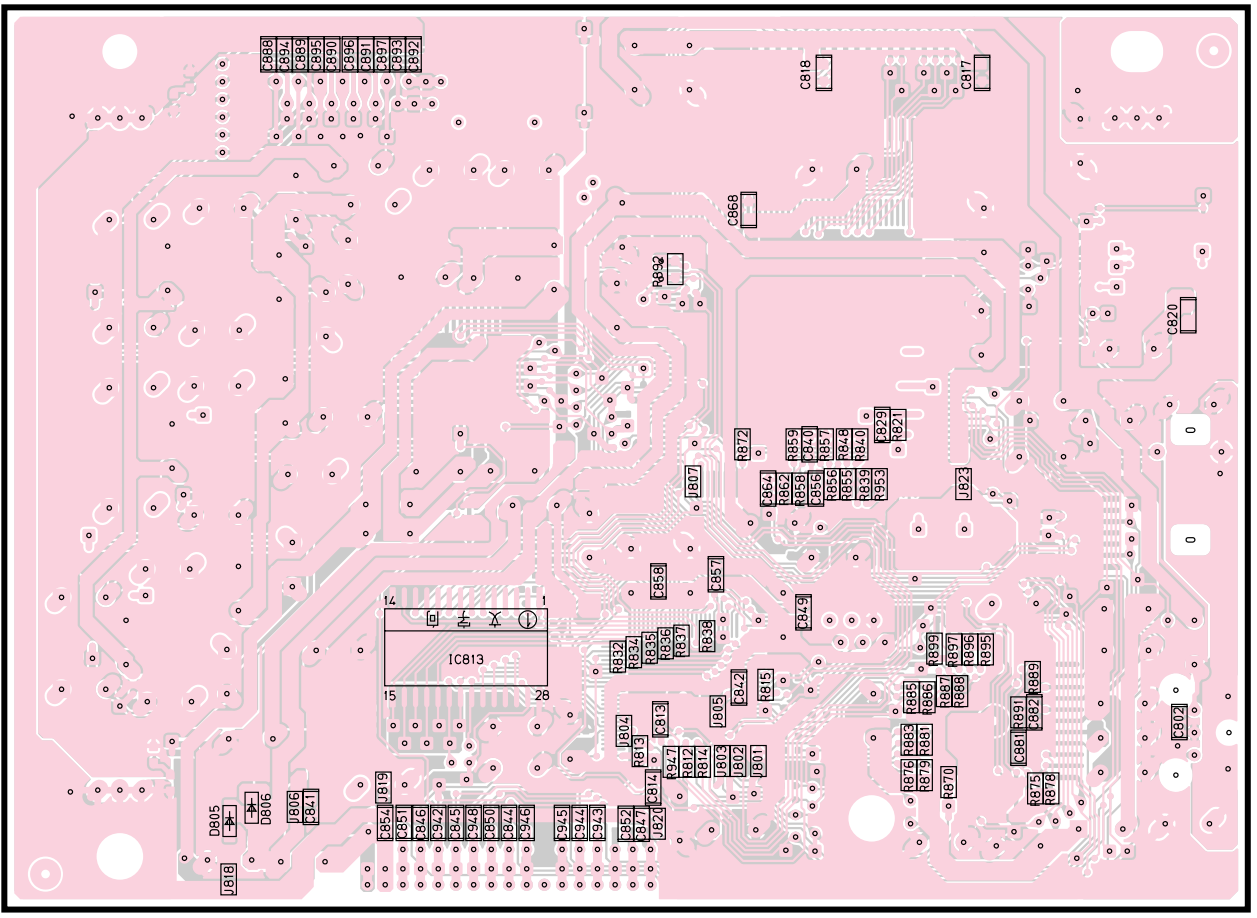

• Semiconductor Location

Ref. No.	Location	Ref. No.	Location
D801	D3	IC803	C3
D802	E3	IC804	B5
D803	B4	IC805	D5
D804	B5	IC806	B3
D805	G5	IC807	E3
D806	G5	IC808	D4
D807	B3	IC809	A4
D808	B3	IC810	A3
D809	B3	IC811	A4
D810	B3	IC812	B5
IC801	D3	IC813	H4
IC802	C5		

PRINTED CIRCUIT BOARD (Foil side)

FUNCTION (2) P.C.B. (Lead Type Device)

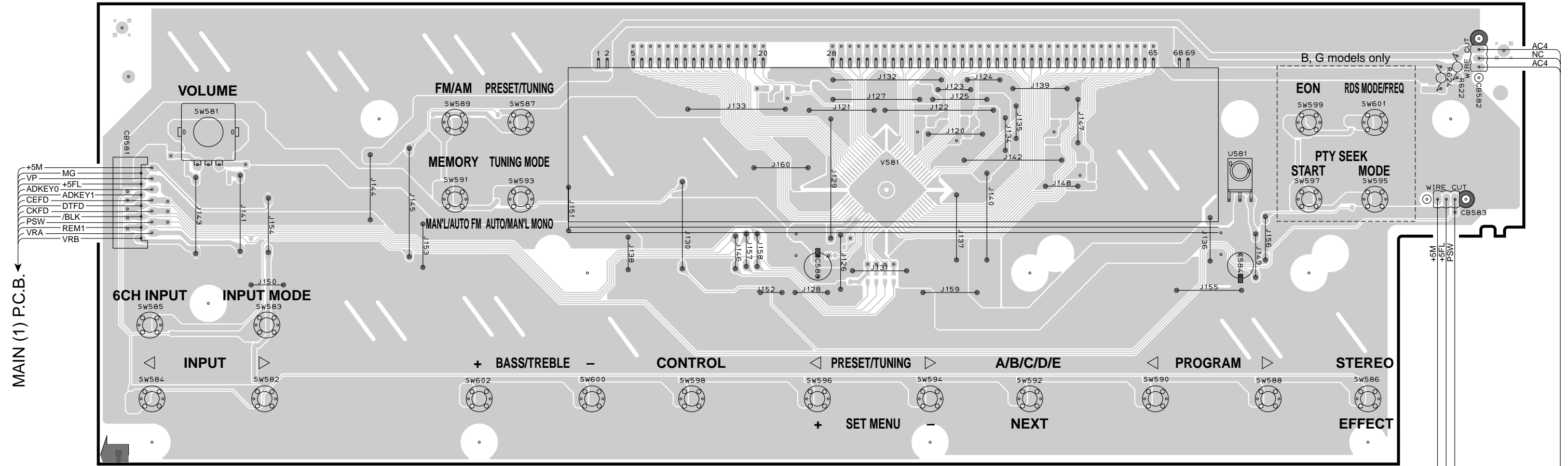

MAIN (1) P.C.B.

FUNCTION (4) P.C.B. (Lead Type Device)

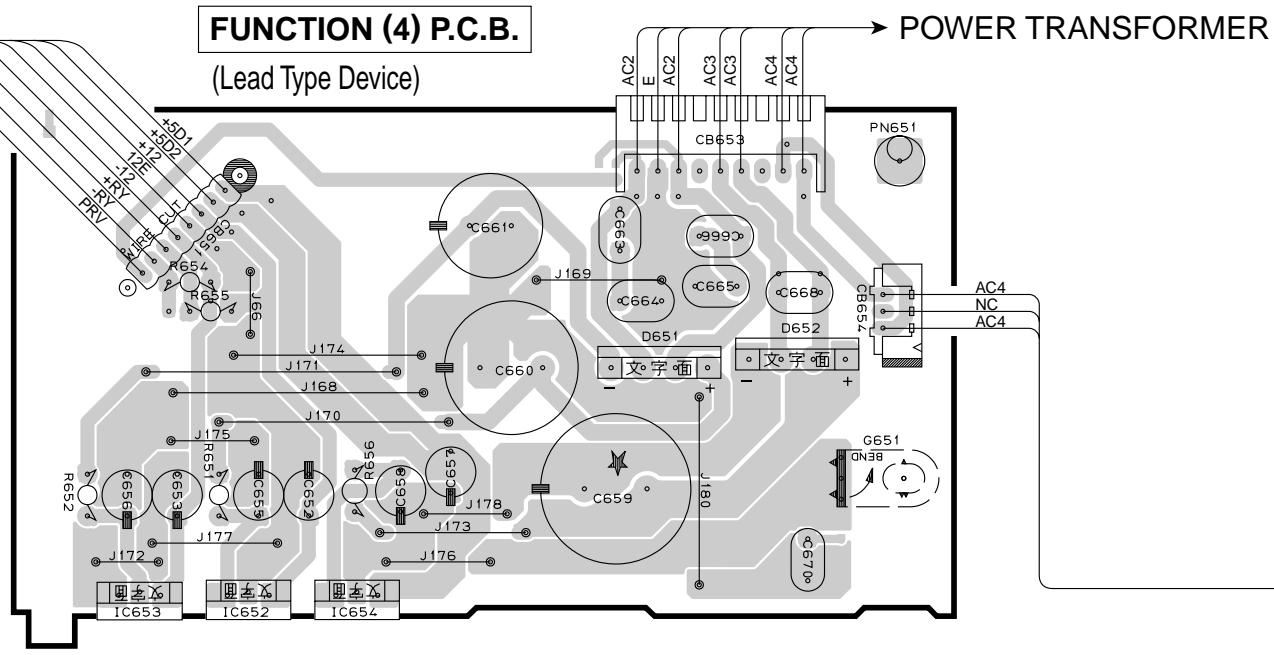

FUNCTION (5) P.C.B. (Lead Type Device)

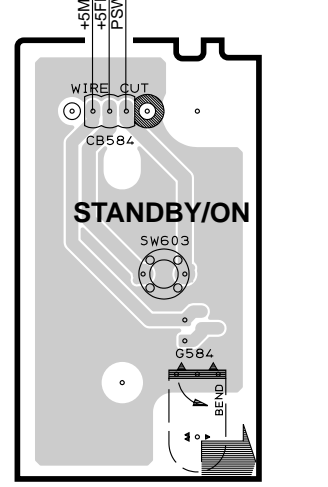

• Semiconductor Location

Ref. No.	Location
D651	F6
D652	F6
IC652	E7
IC653	D7
IC654	E7

1 ■ PRINTED CIRCUIT BOARD (Foil side)

FUNCTION (2) P.C.B. (Surface Mount Device)

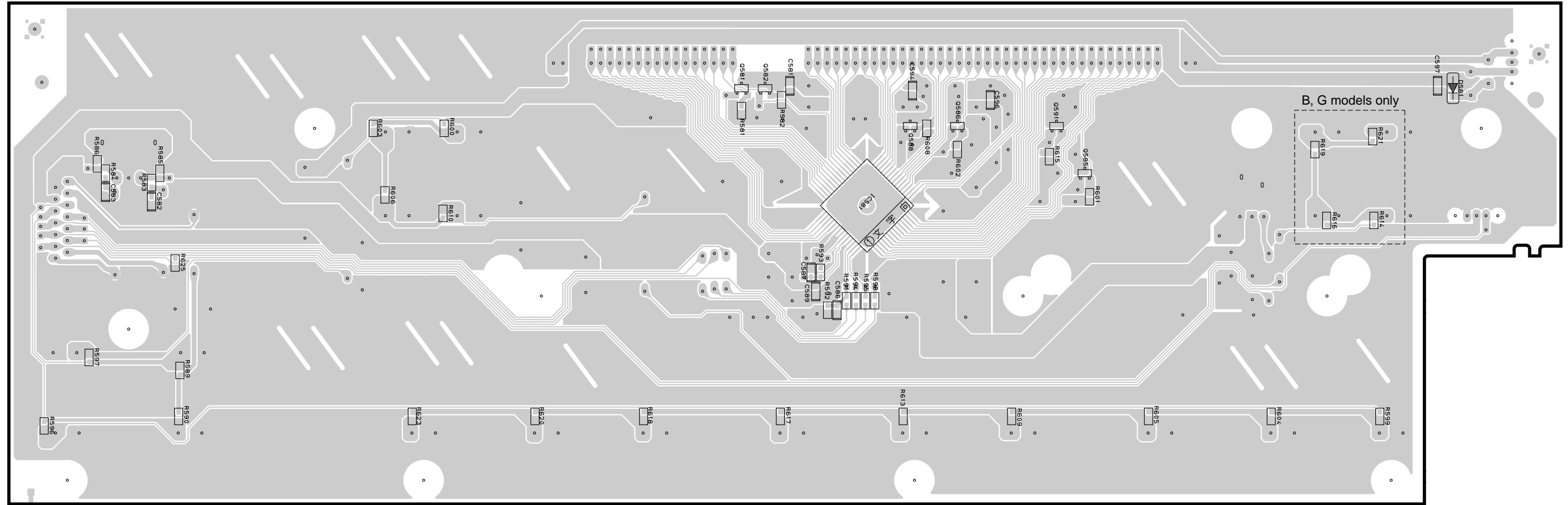

FUNCTION (4) P.C.B. (Surface Mount Device)

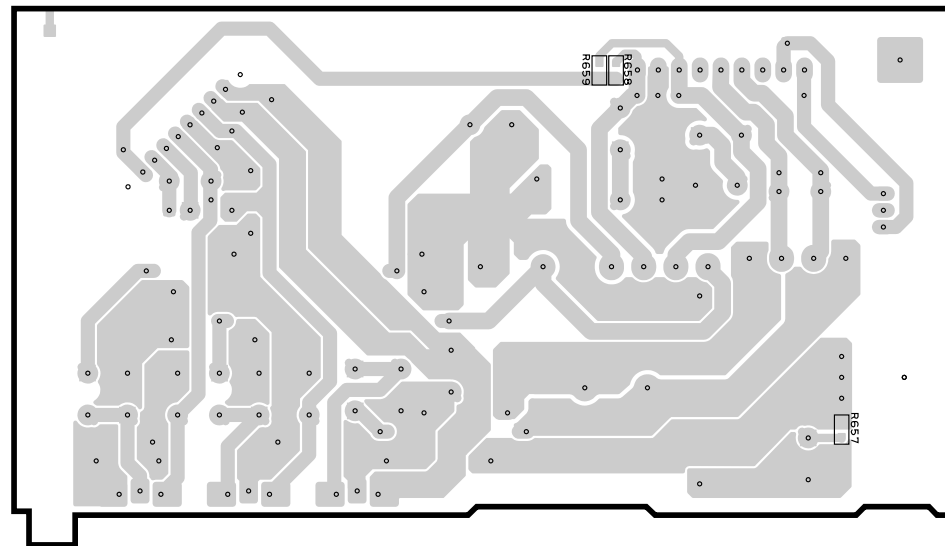

FUNCTION (5) P.C.B. (Surface Mount Device)

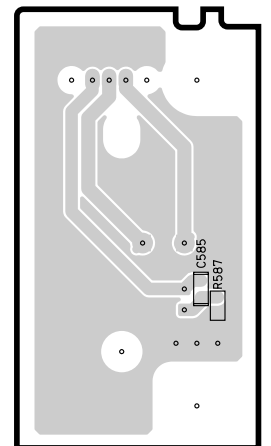

• Semiconductor Location

Ref. No.	Location
D581	I2
IC581	F3
Q581	E2
Q582	E2
Q585	G2
Q586	F2
Q588	F2

PRINTED CIRCUIT BOARD (Foil side)

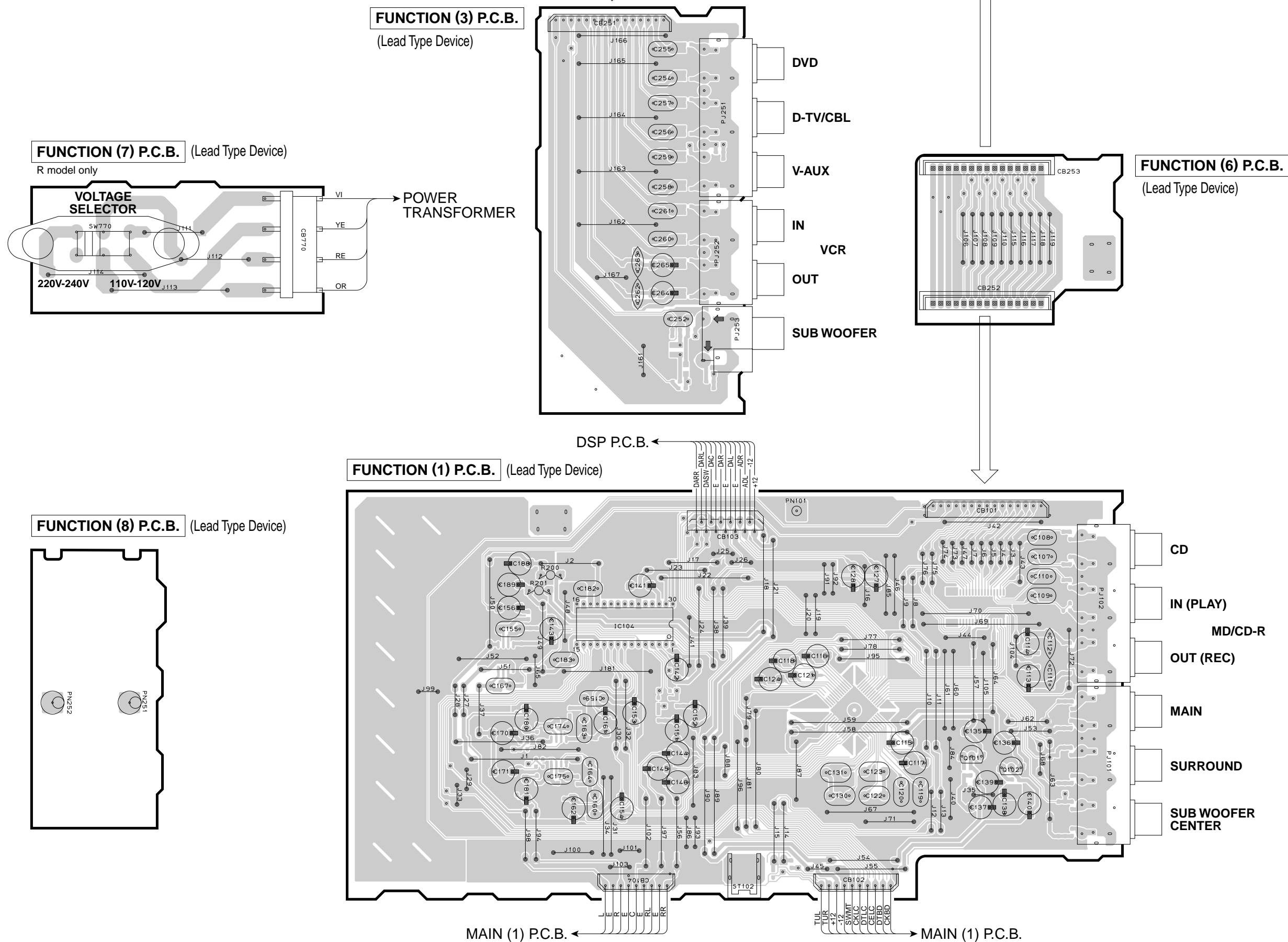

• Semiconductor Location

Ref. No.	Location
IC104	E5
Q101	G6
Q102	G6

1

PRINTED CIRCUIT BOARD (Foil side)

2

3

4

5

6

7

FUNCTION (3) P.C.B.

(Surface Mount Device)

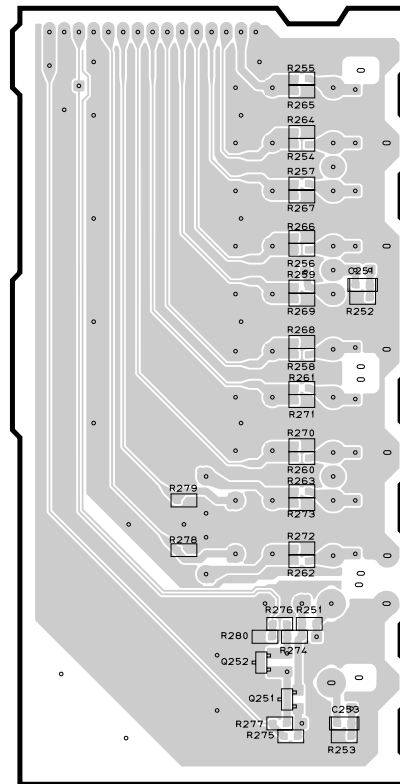

FUNCTION (1) P.C.B.

(Surface Mount Device)

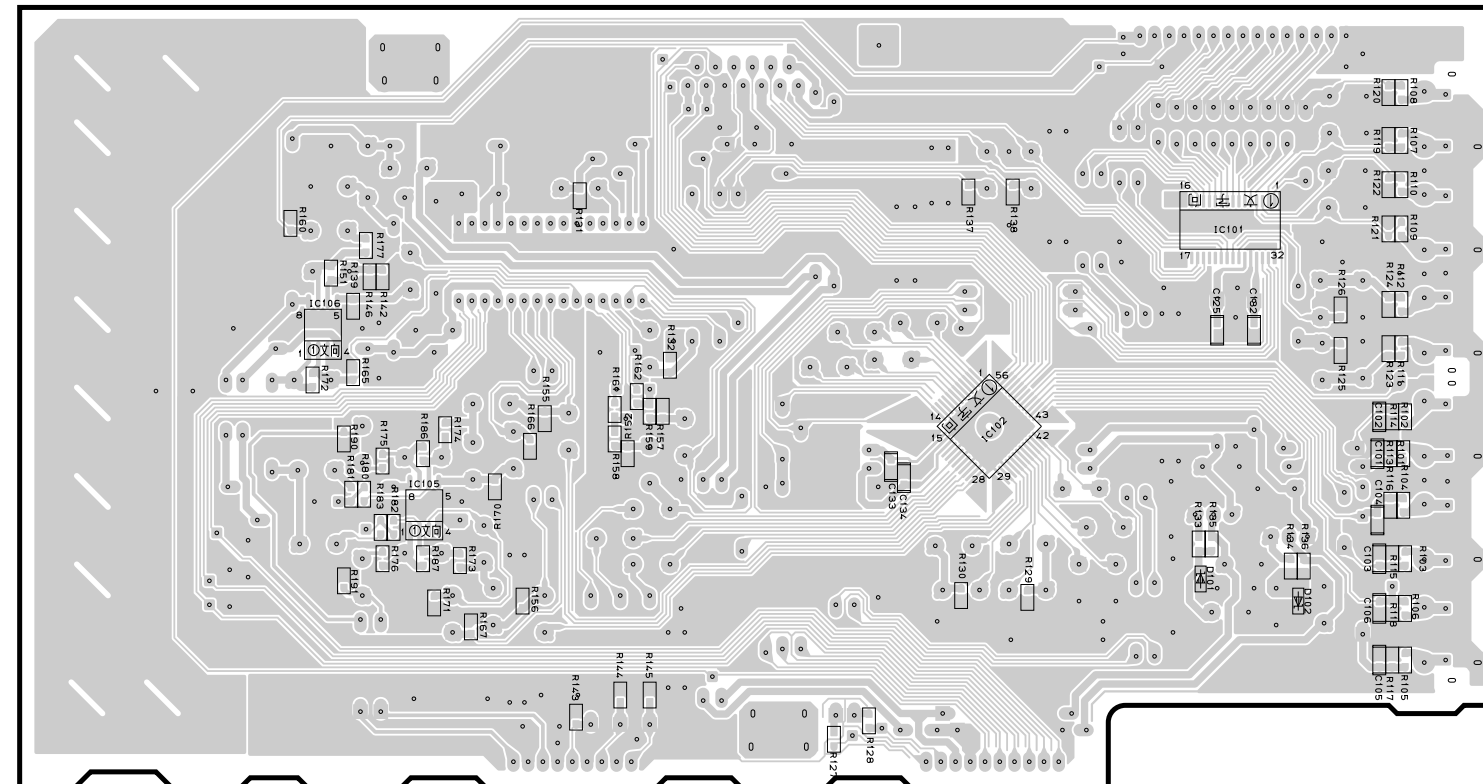

• Semiconductor Location

Ref. No.	Location
D101	F6
D102	G6
IC101	F5
IC102	F6
IC105	D6
IC106	C5
Q251	E4
Q252	D4
Q591	G2

PRINTED CIRCUIT BOARD (Foil side)

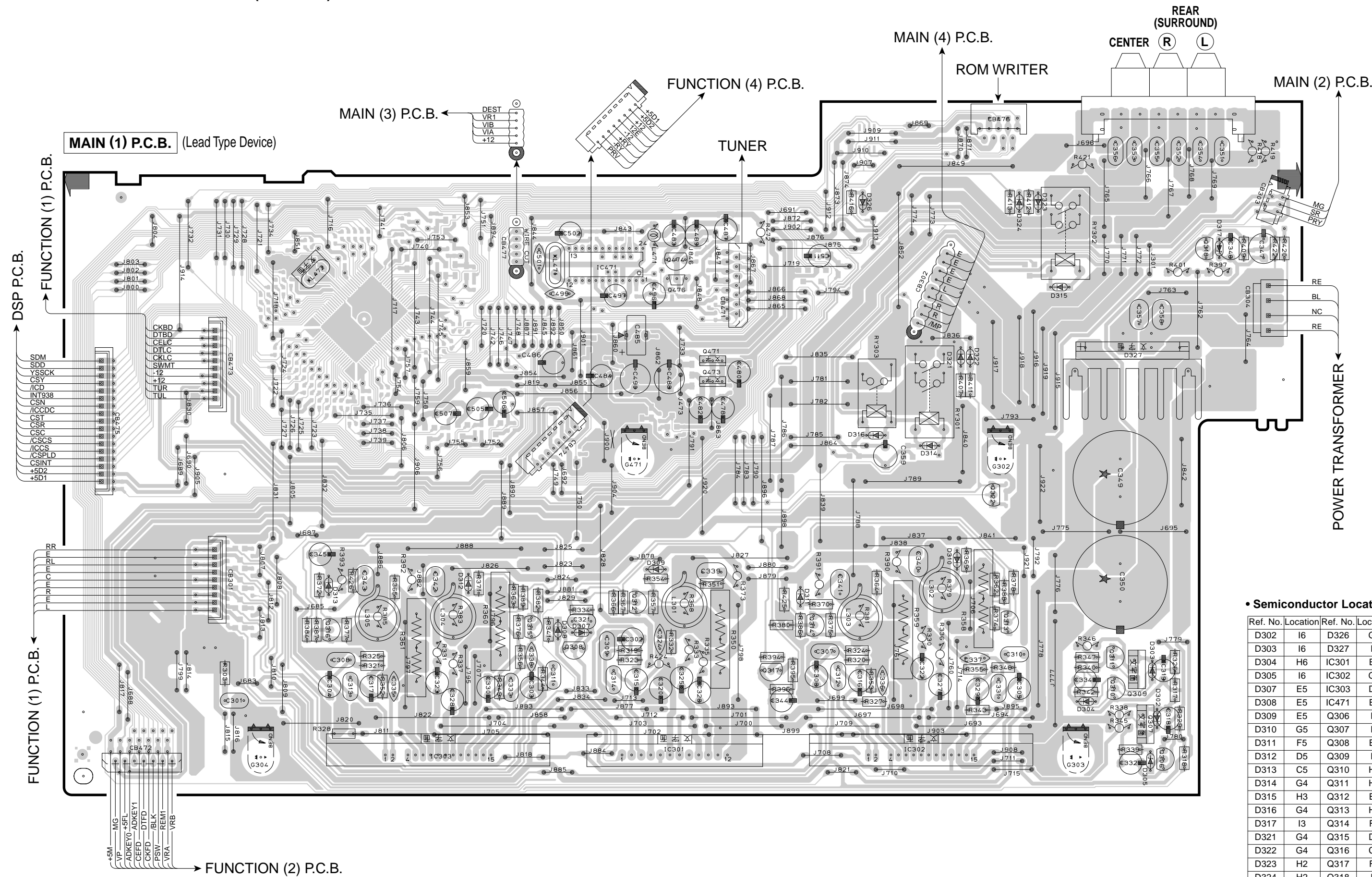

• Semiconductor Location

Ref. No.	Location	Ref. No.	Location
D302	I6	D326	G2
D303	I6	D327	I4
D304	H6	IC301	E6
D305	I6	IC302	G6
D307	E5	IC303	D6
D308	E5	IC471	E3
D309	E5	Q306	I6
D310	G5	Q307	I6
D311	F5	Q308	E6
D312	D5	Q309	I6
D313	C5	Q310	H6
D314	G4	Q311	H6
D315	H3	Q312	E5
D316	G4	Q313	H5
D317	I3	Q314	F5
D321	G4	Q315	D5
D322	G4	Q316	C5
D323	H2	Q317	F6
D324	H2	Q318	I3

1 ■ PRINTED CIRCUIT BOARD (Foil side)

2 **MAIN (1) P.C.B.** (Surface Mount Device)

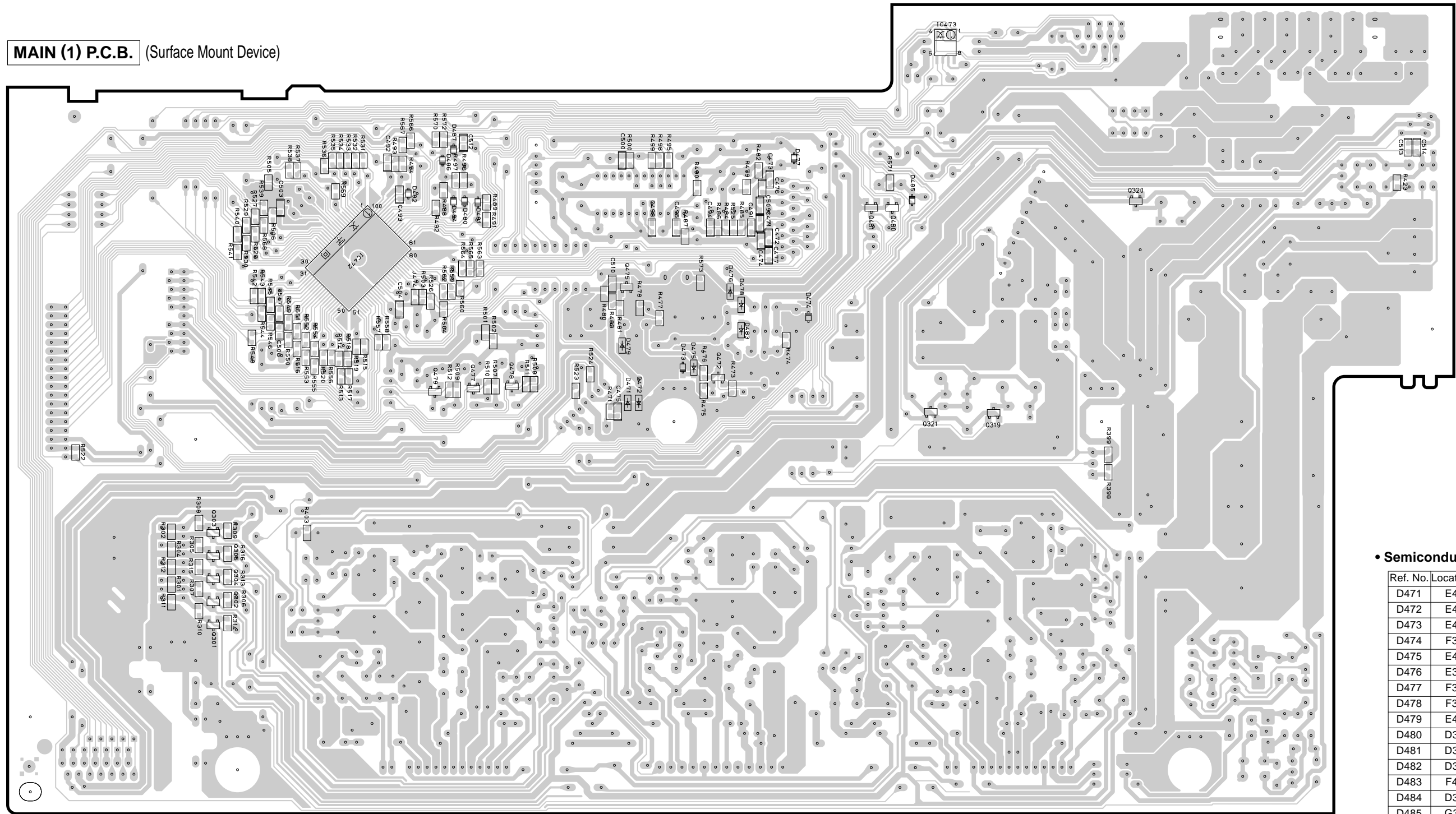

• Semiconductor Location

Ref. No.	Location
D471	E4
D472	E4
D473	E4
D474	F3
D475	E4
D476	E3
D477	F3
D478	F3
D479	E4
D480	D3
D481	D3
D482	D3
D483	F4
D484	D3
D485	G3
D486	D3
D487	D2
IC472	C3
Q301	B5
Q302	B5
Q303	B5
Q304	B5
Q305	B5

PRINTED CIRCUIT BOARD (Foil side)

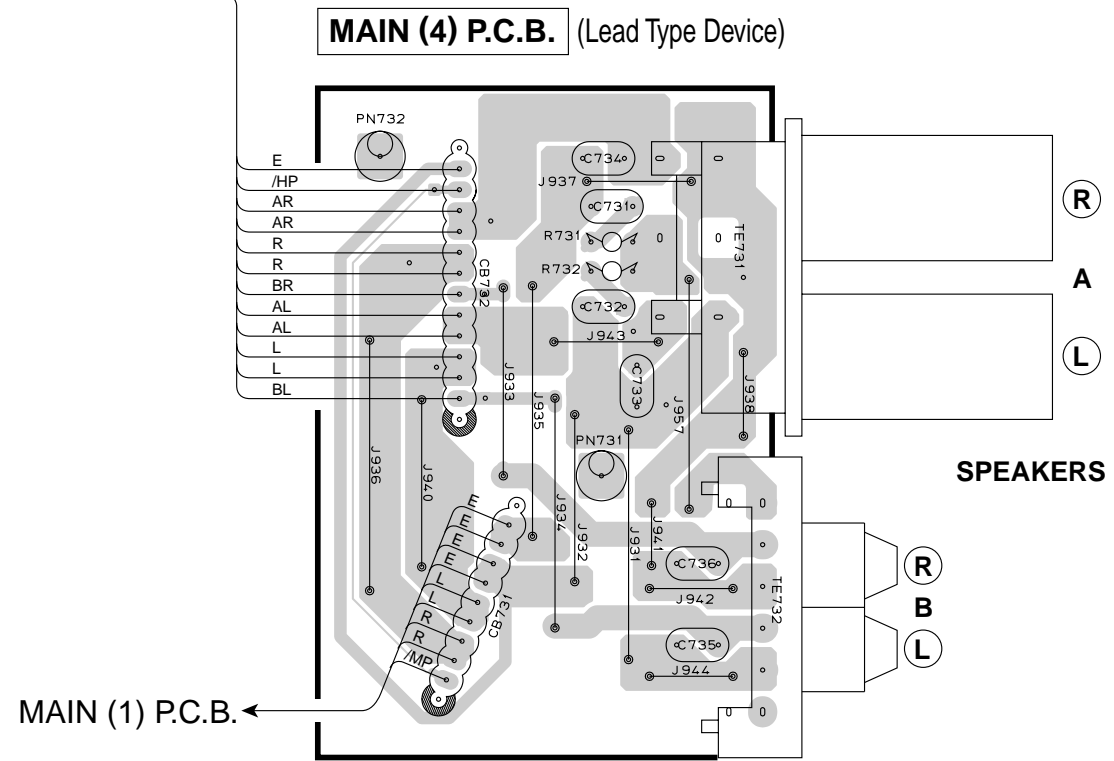
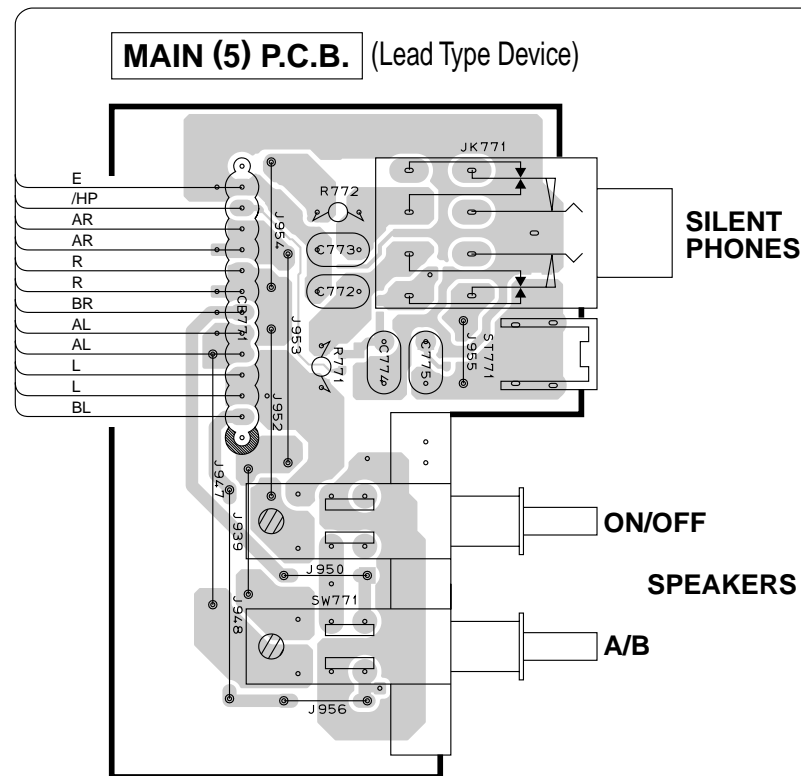
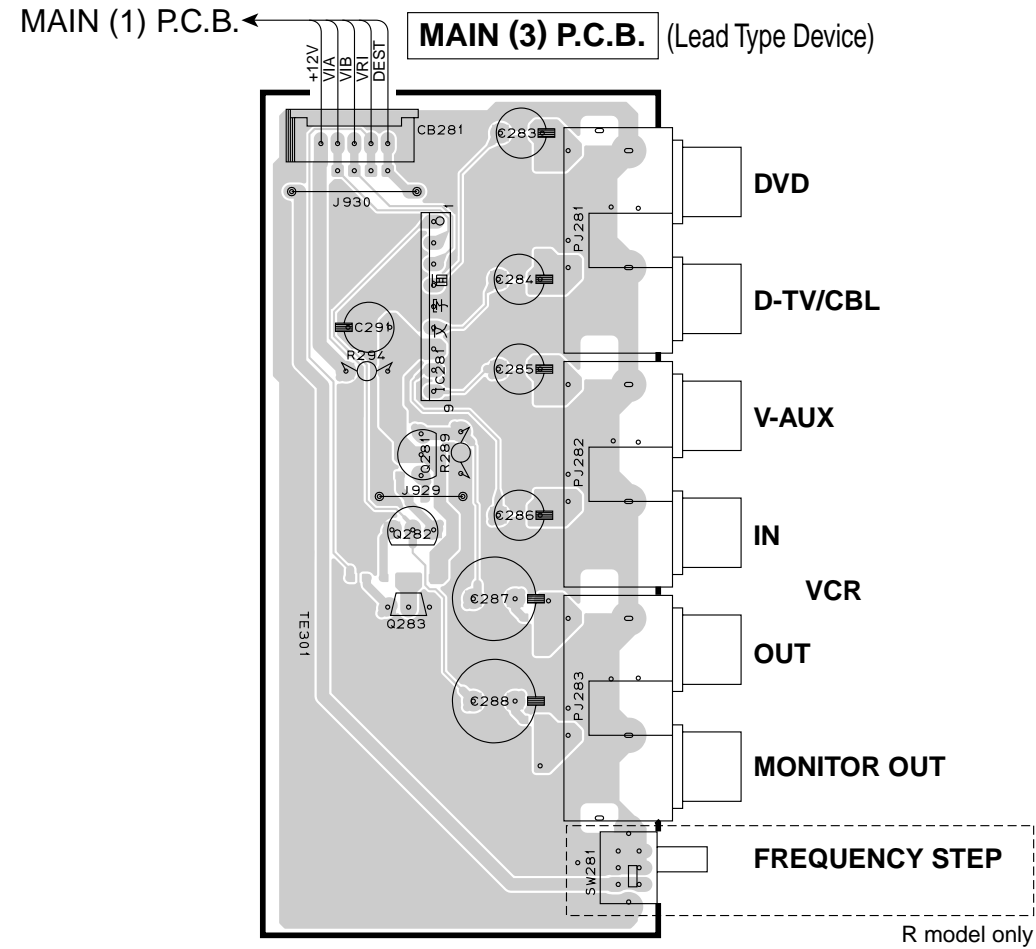
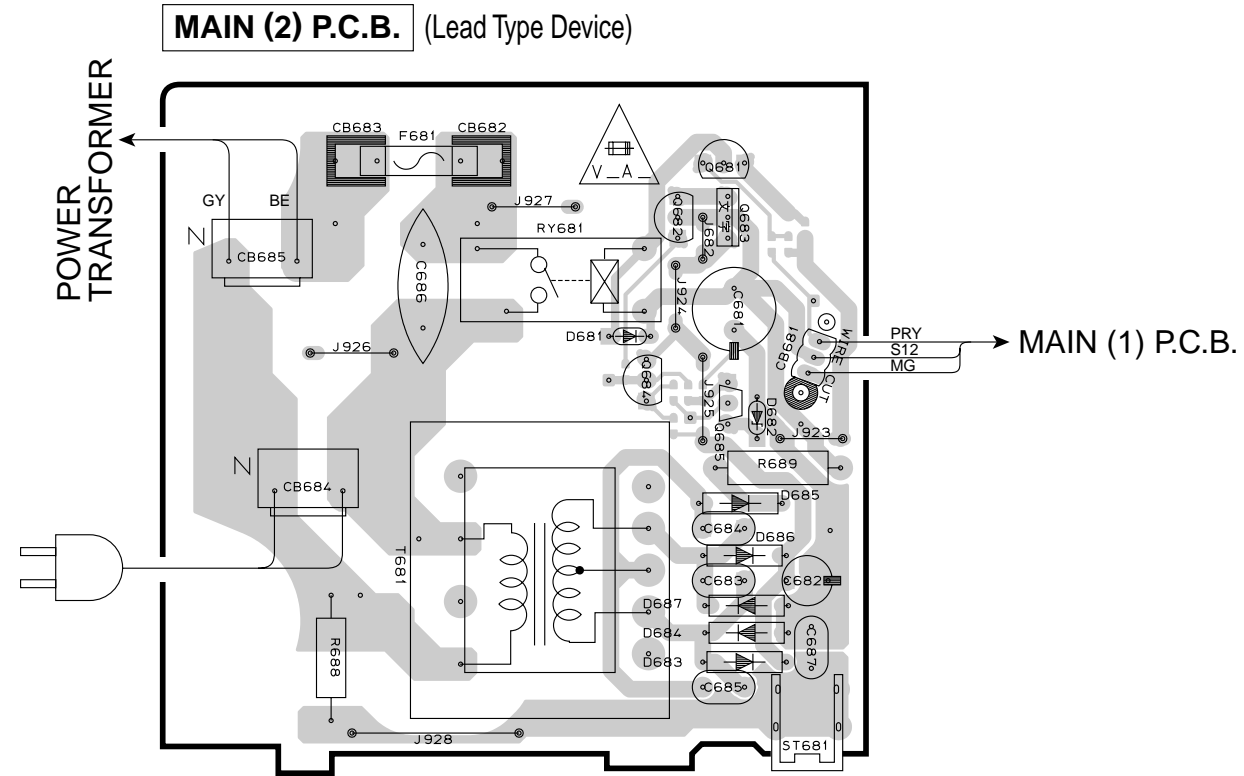

• Semiconductor Location

Ref. No.	Location
D681	C2
D682	D3
D683	D3
D684	D3
D685	D3
D686	D3
D687	D3
IC281	G2
Q281	G3
Q282	G3
Q283	G3

■ PIN CONNECTION DIAGRAM

• ICs

<p>KIA7805PI5V KIA7812PI</p>	<p>KIA7912PI</p>	<p>μPC29M33T-E1</p>	<p>PQ025EZ5MZP</p>	<p>NJM2068MD</p>	<p>LA7956</p>	<p>MM74HCU04 TC74HCT08AF</p>
<p>LC72722</p>	<p>TC74HC4053AF</p>	<p>CY62556LL</p>	<p>BD3841FS</p>	<p>MSM514260E-60JS</p>		
<p>STK404-120</p>	<p>STK402-120Y</p>	<p>BD3815KS</p>	<p>LC75712E</p>	<p>CS493292-CLR</p>		
<p>AK4529VQ</p>	<p>M3062VMGP-070FP</p>	<p>XC9572XL-10TQ100C</p>	<p>YSS938</p>			

• Diodes

<p>1SS133 1SS270A 1T2</p>	<p>MTZJ20B MTZJ22A MTZJ4.7A MTZJ30A</p>	<p>1SS355 MA8075-H RLZ6.2B UDZ5.1B UDZ6.8B UDZS5.6BTE-17 UDZS6.2B UDZS9.1B</p>
<p>TS6P03G</p>	<p>KBP103G</p>	<p>SB01-05Q</p>

• Transistors

<p>2SA893A 2SA1015 2SB949 2SC1815 2SC1890A 2SC2705</p>	<p>2SC1740S DTC114ES</p>	<p>2SB1274 2SD1913</p>
<p>2SA1037K 2SC2412K 2SC3326 DTA144EKA</p>	<p>2SA1708 2SC4488</p>	

BLOCK DIAGRAM

1
2
3
4
5
6
7
8
9

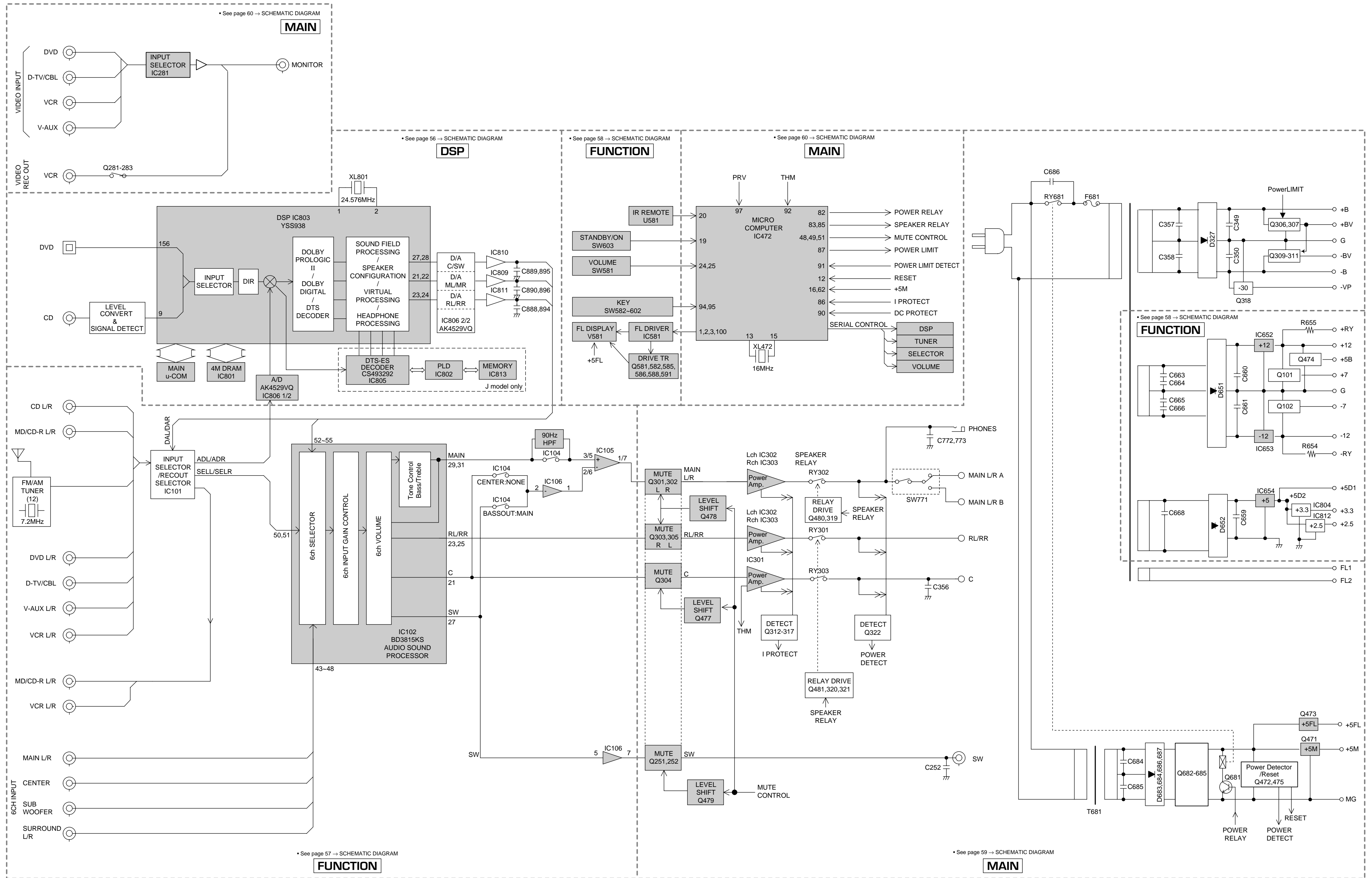

SCHEMATIC DIAGRAM (DSP)

RESISTOR

REMARKS	PARTS NAME
NO MARK	CARBON FILM RESISTOR (P=5)
□	CARBON FILM RESISTOR (P=10)
△	METAL OXIDE FILM RESISTOR
◇	METAL FILM RESISTOR
○	METAL PLATE RESISTOR
⊕	FINE PROOF CARBON FILM RESISTOR
⊙	CEMENT MOLDED RESISTOR
⊚	SEMI-VARIABLE RESISTOR
⊛	CHIP RESISTOR

CAPACITOR

REMARKS	PARTS NAME
NO MARK	ELECTROLYTIC CAPACITOR
⊗	TANTALUM CAPACITOR
NO MARK	CERAMIC CAPACITOR
⊙	CERAMIC TUBULAR CAPACITOR
⊚	POLYESTER FILM CAPACITOR
○	POLYSTYRENE FILM CAPACITOR
◇	MICA CAPACITOR
⊕	POLYPROPYLENE FILM CAPACITOR
⊙	SEMICONDUCTIVE CERAMIC CAPACITOR
⊚	POLYPHENYLENE SULFIDE FILM CAPACITOR

Interchangeable Parts at Manufacture-Stage

Mark	Reference Parts Number	Parts Name
1	IC801	M96F48002-60J5 6L744018-40J4 15A1C16297-39K 1C41C16297-60K
2	UB01	GP1FA5912Z GP1FA5932Z T084179
3	IC807	MM74HC045JX TC74HC04AFEL
4	IC808	AX4529VQ AK4628VQ

U.C.R.T.K.A.B.G
J: JAPAN
U: U.S.A
C: CANADA
R: GENERAL
T: CHINA
K: KOREA
A: AUSTRALIA
B: BRITISH
G: EUROPE
L: SINGAPORE

NOTICE (model)

S	Parts Number	J	U.C.R.T.K.A.B.G	MEMO
1	RB39	×	4.7K RD39647	AAC
2	JB07	×	0 RD39000	AAC
3	RB60-861-863	×	100 RB6010	AAC
4	RB60-863-866	×	27 RB6010	AAC
5	CB44-B45-B46	×	US05L47	AAC
6	811 Parts enclosed	×	Assemble	AAC
7	CB48	×	US05L10	AAC
8	JB17	×	WA03450	EMC
9	JB21-B22-B23-B24	×	RD35000	EMC
10	LB02-B03	×	WA03450	V476950 EMC

X: NOT USED
O: USED/APPLICABLE

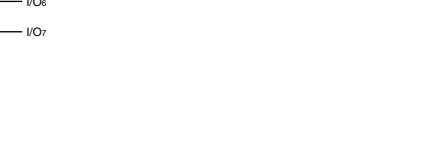
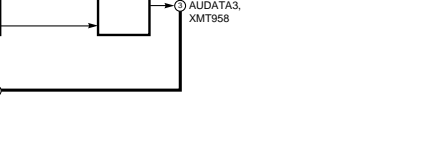
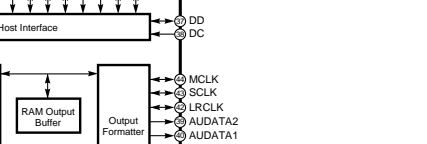
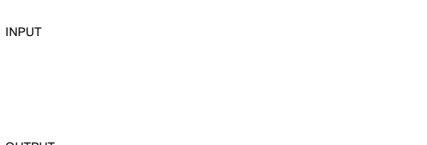
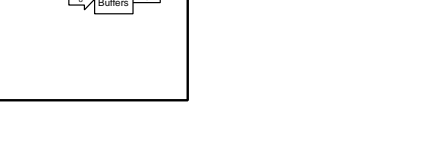
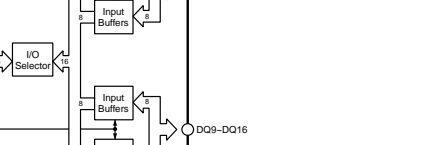
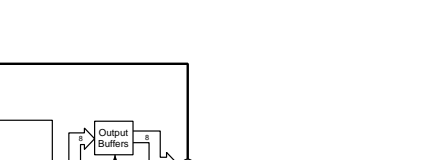
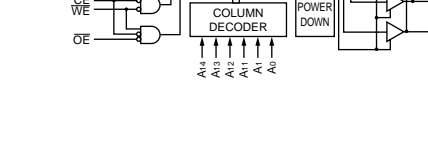
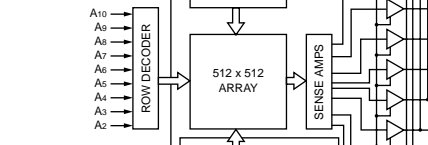
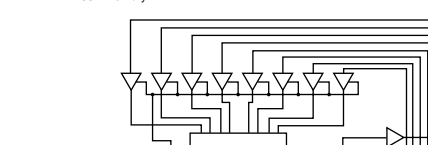
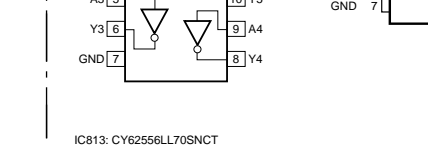
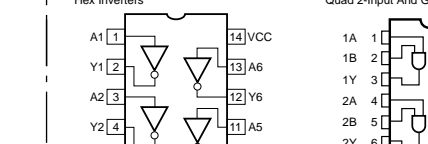
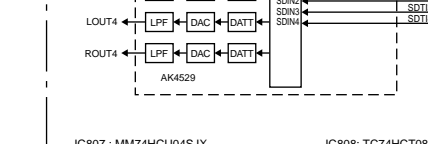
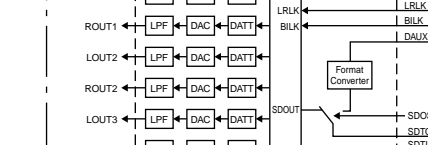
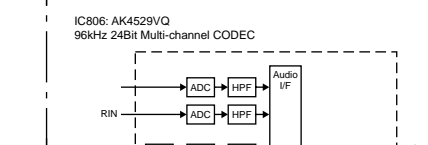
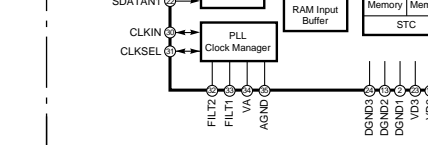
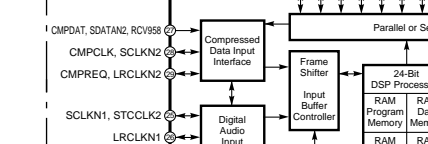
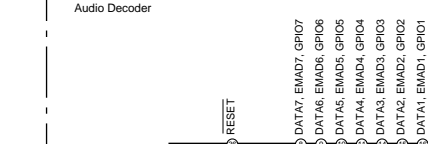
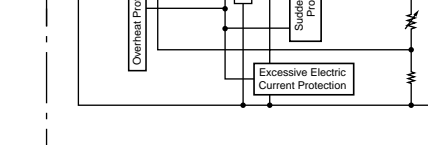
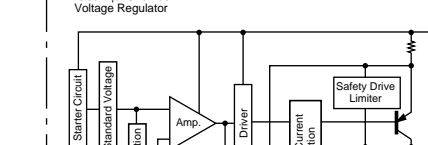
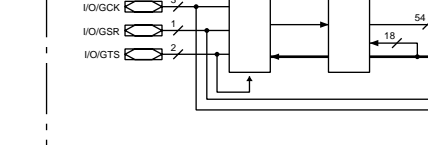
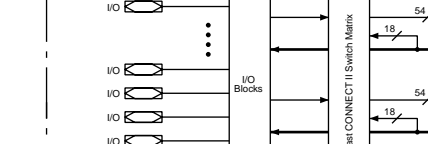
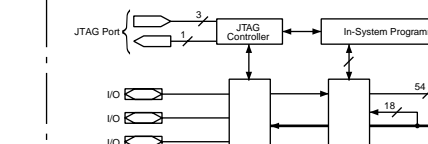
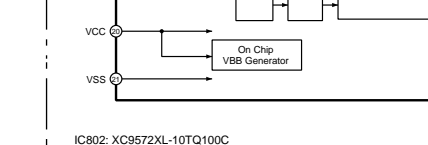
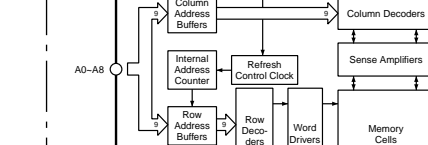
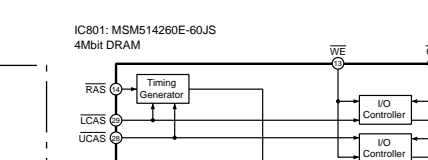
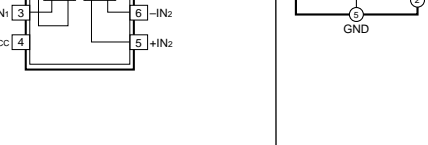
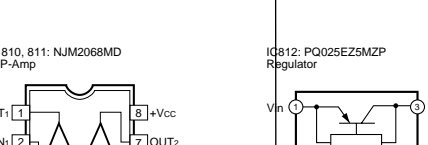
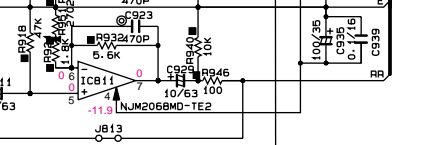
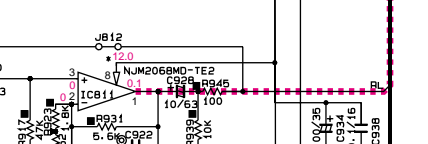
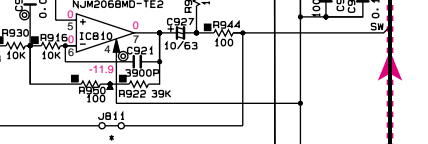
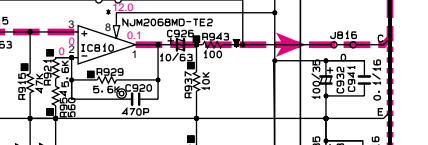
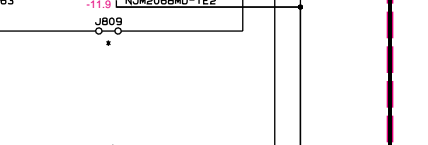
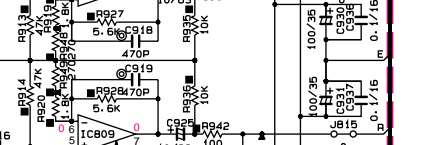
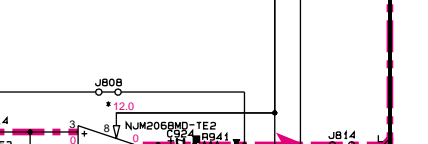
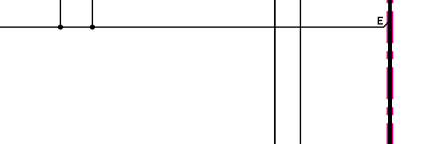
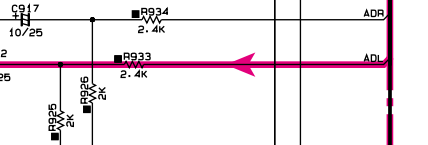
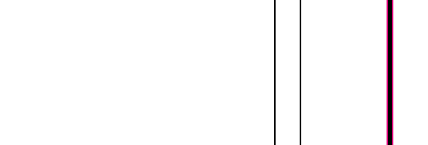
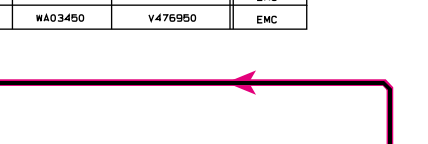
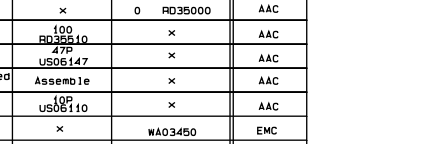
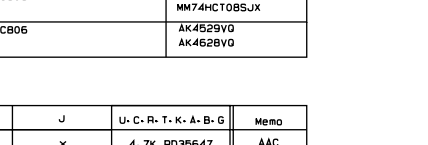
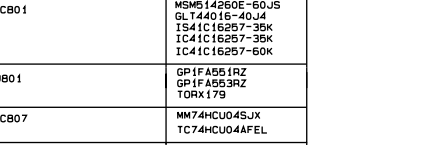
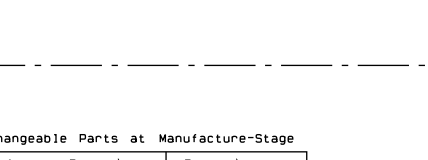
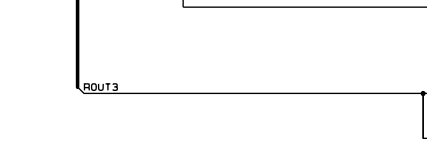
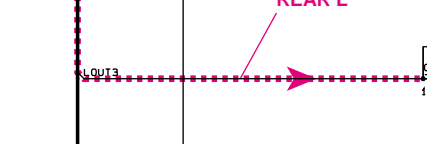
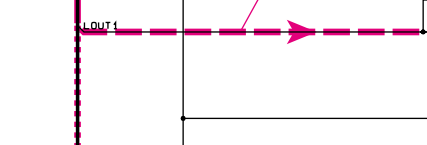
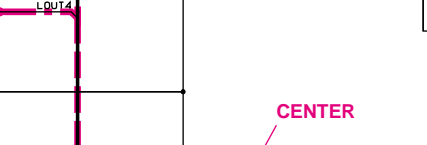
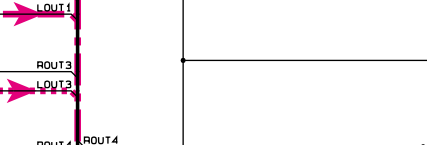
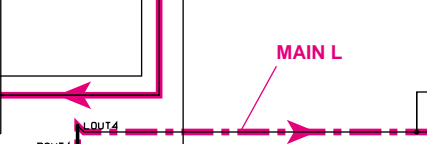
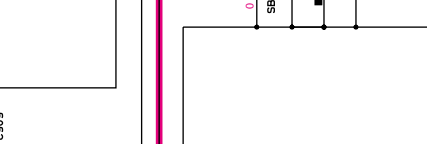
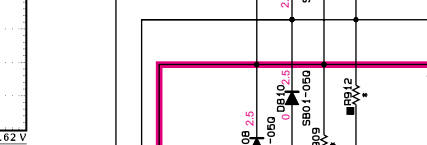
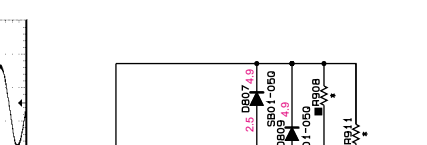
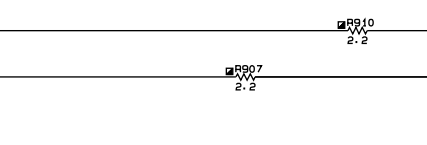
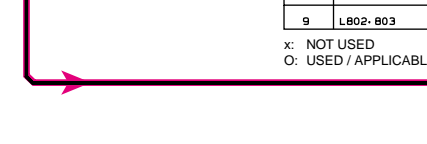
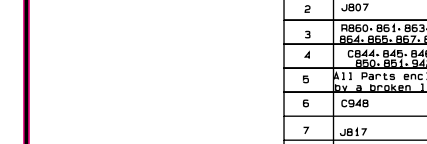
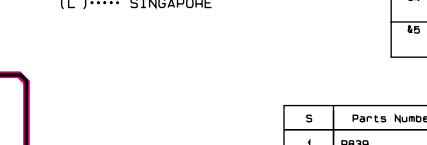
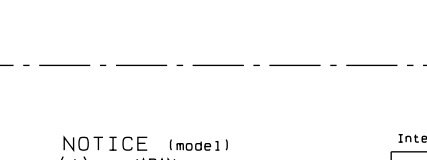
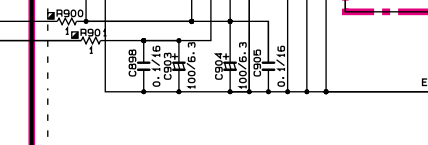
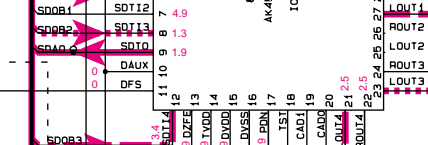
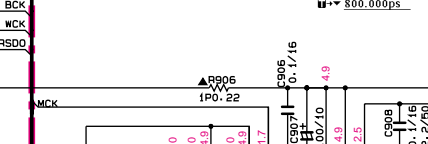
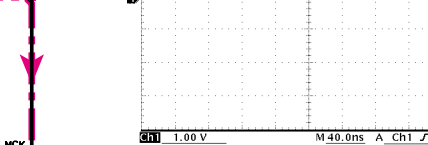
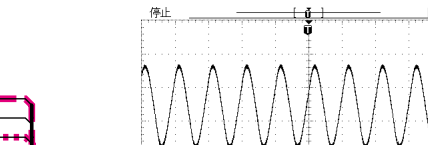
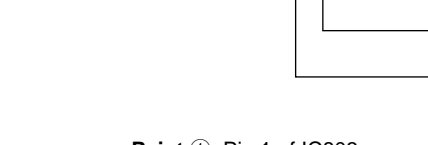
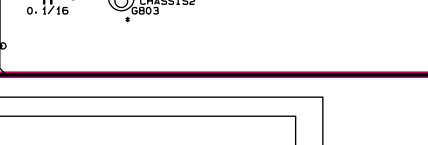
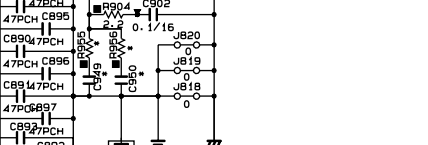
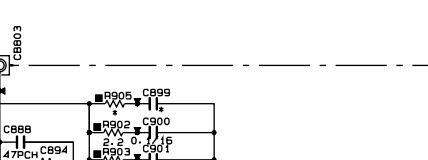
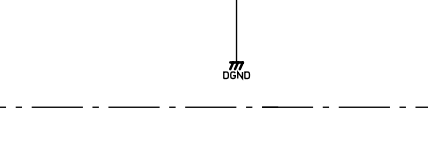
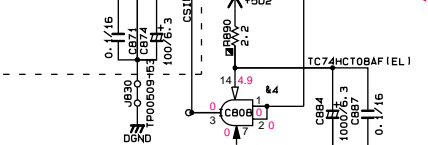
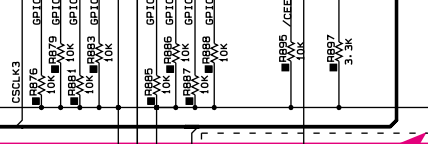
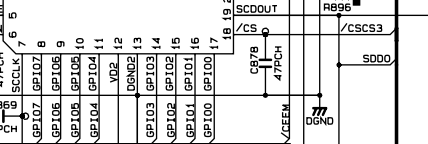
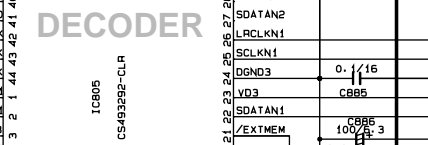
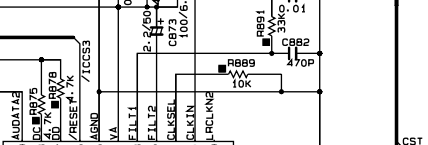
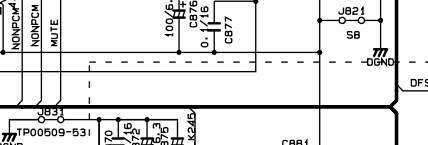
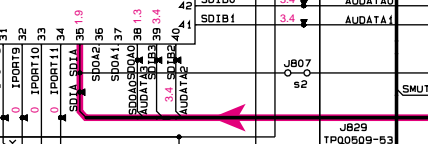
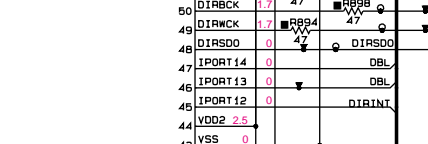
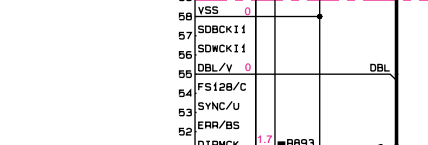
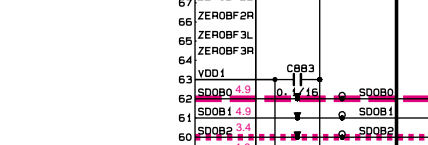
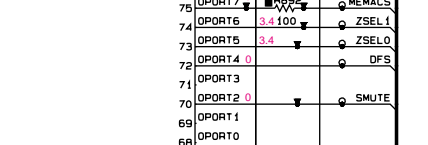
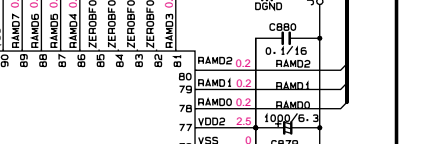
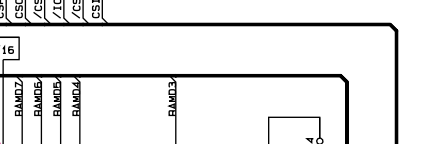
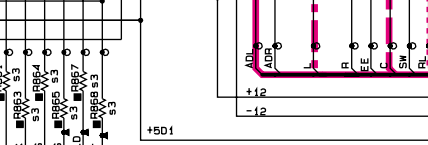
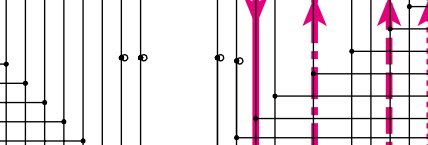
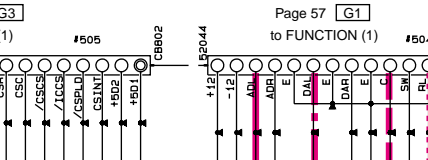
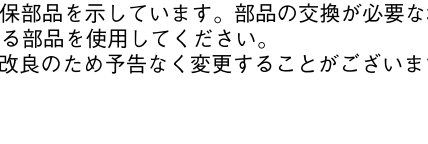
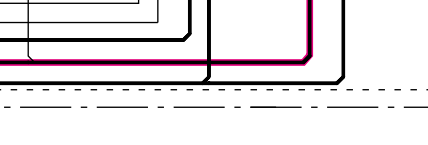
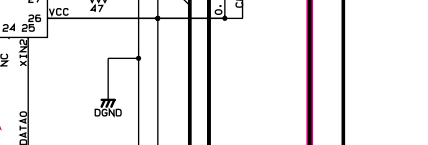
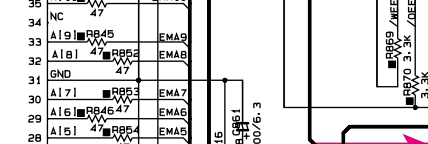
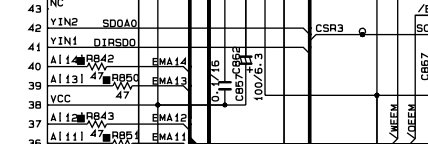
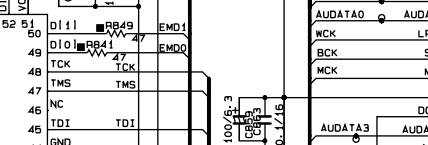
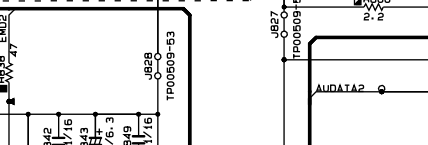
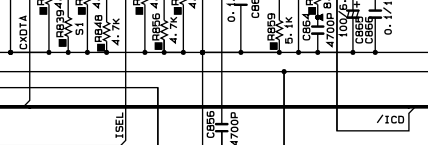
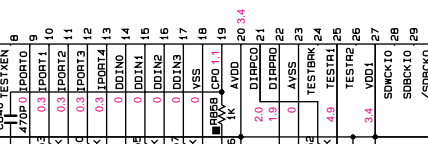
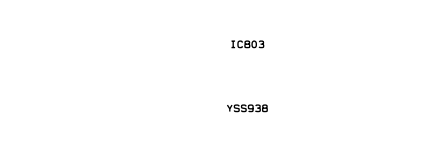
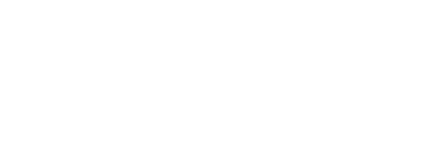
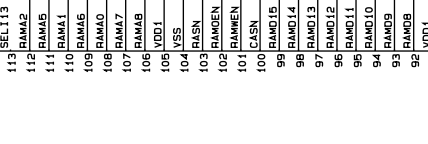
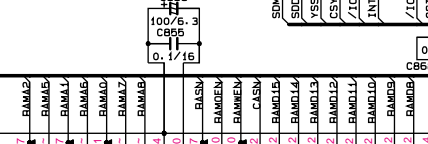
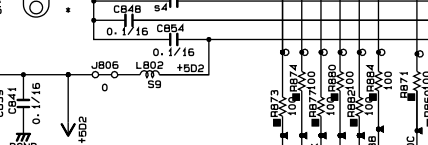
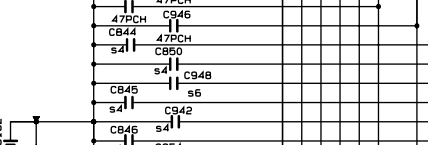
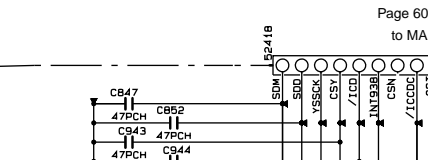
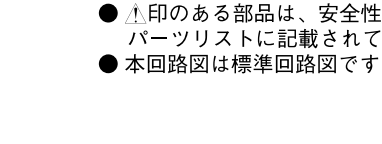
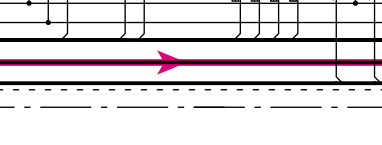
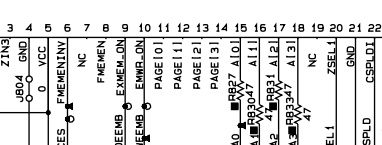
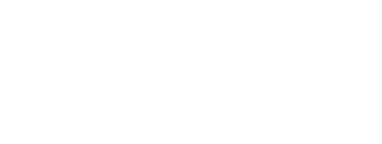
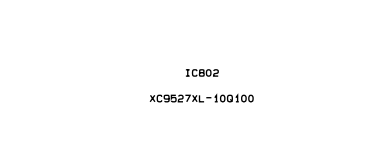
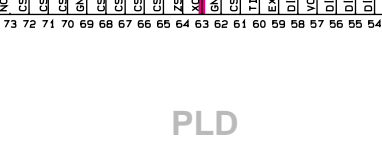
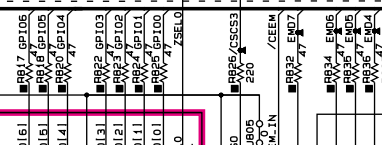
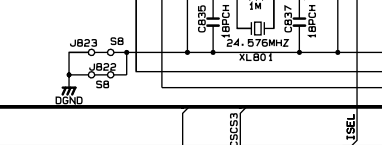
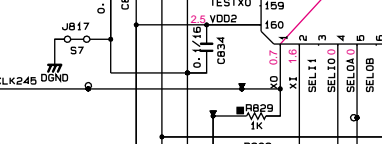
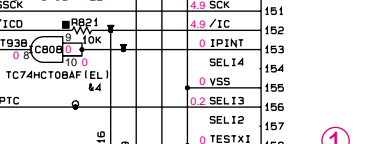
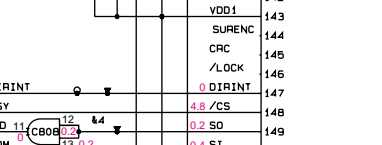
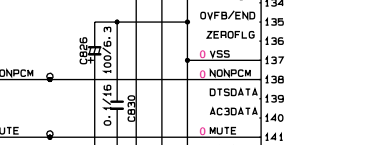
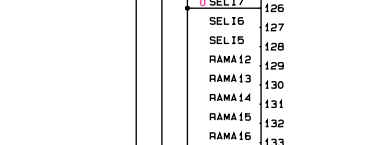
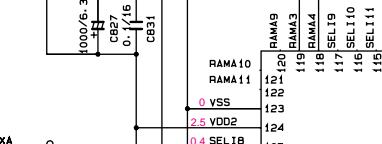
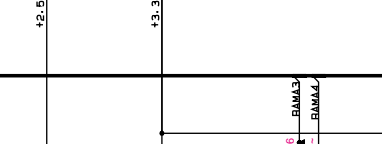
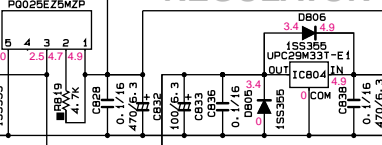
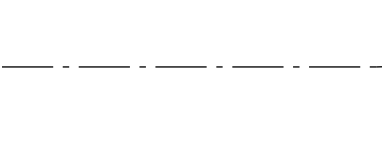
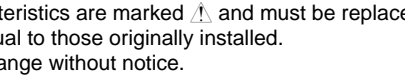
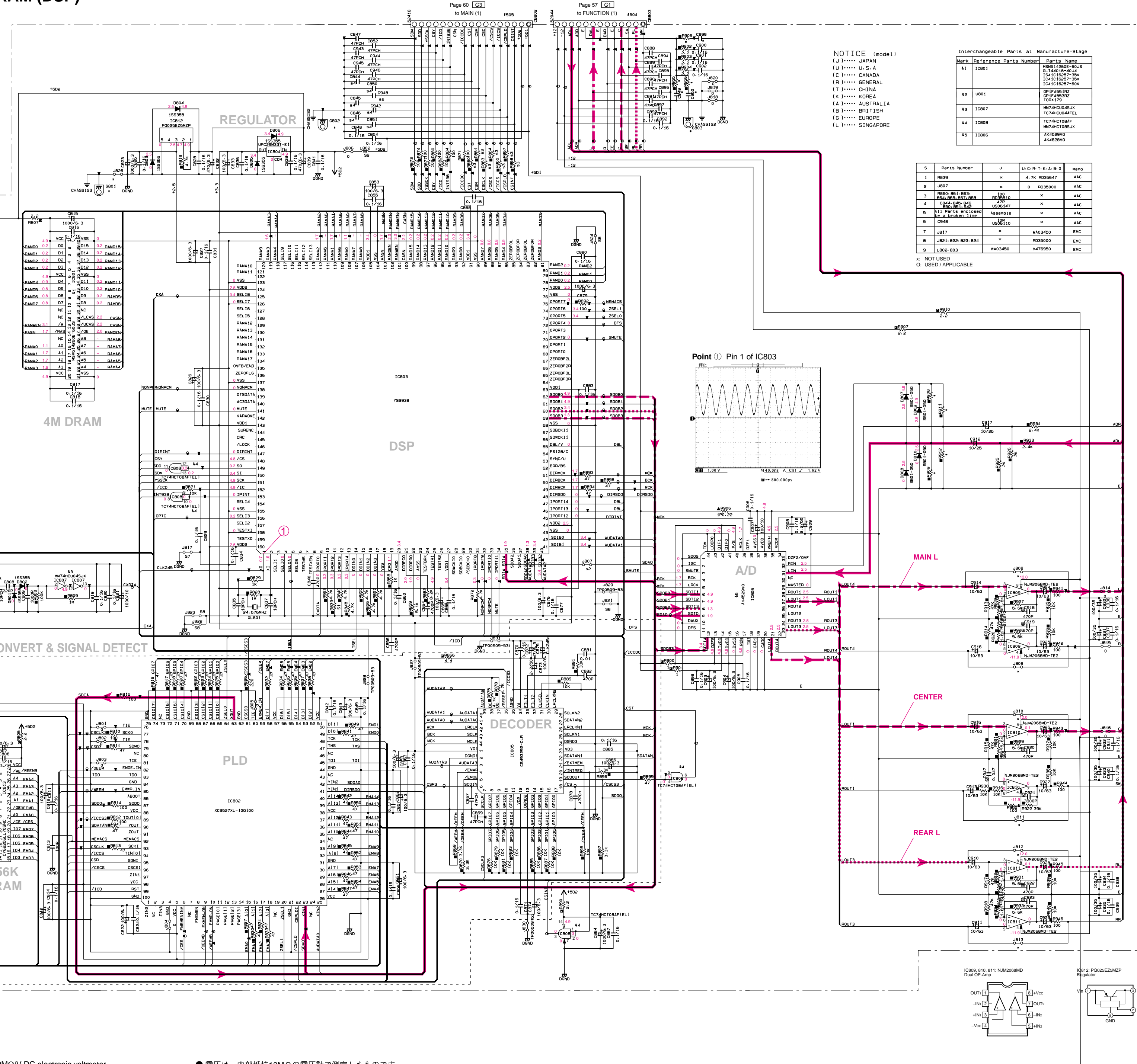
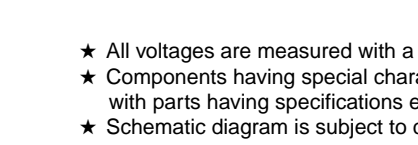
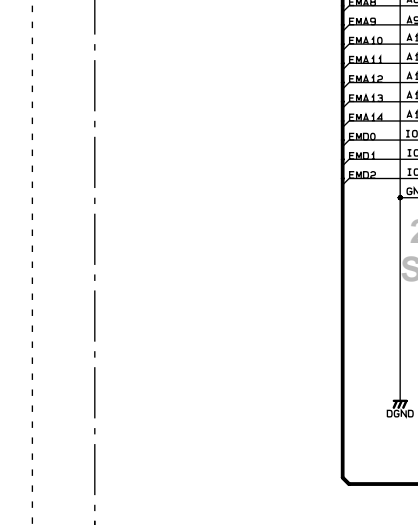
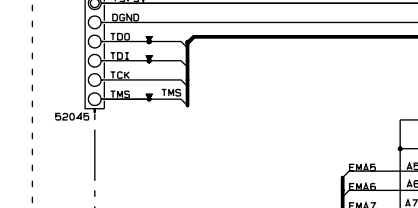
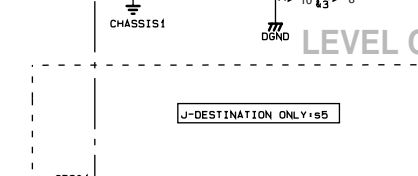
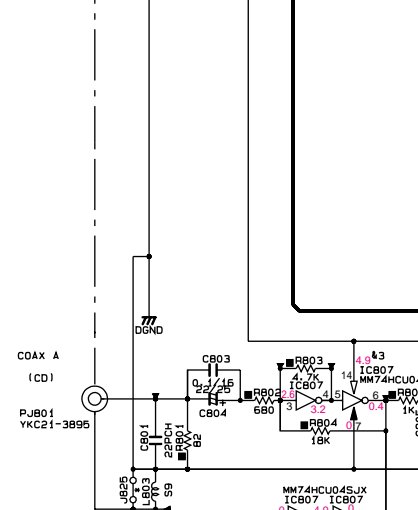

★ All voltages are measured with a 10MΩ/V DC electronic voltmeter.
 ★ Components having special characteristics are marked with a triangle and must be replaced with parts having specifications equal to those originally installed.
 ★ Schematic diagram is subject to change without notice.

● 電圧は、内部抵抗10MΩの電圧計で測定したものです。
 ● 印のある部品は、安全性確保部品を示しています。部品の交換が必要な場合、パーツリストに記載されている部品を使用してください。
 ● 本回路図は標準回路図です。改良のため予告なく変更することがございます。

SCHEMATIC DIAGRAM (FUNCTION 1/2)

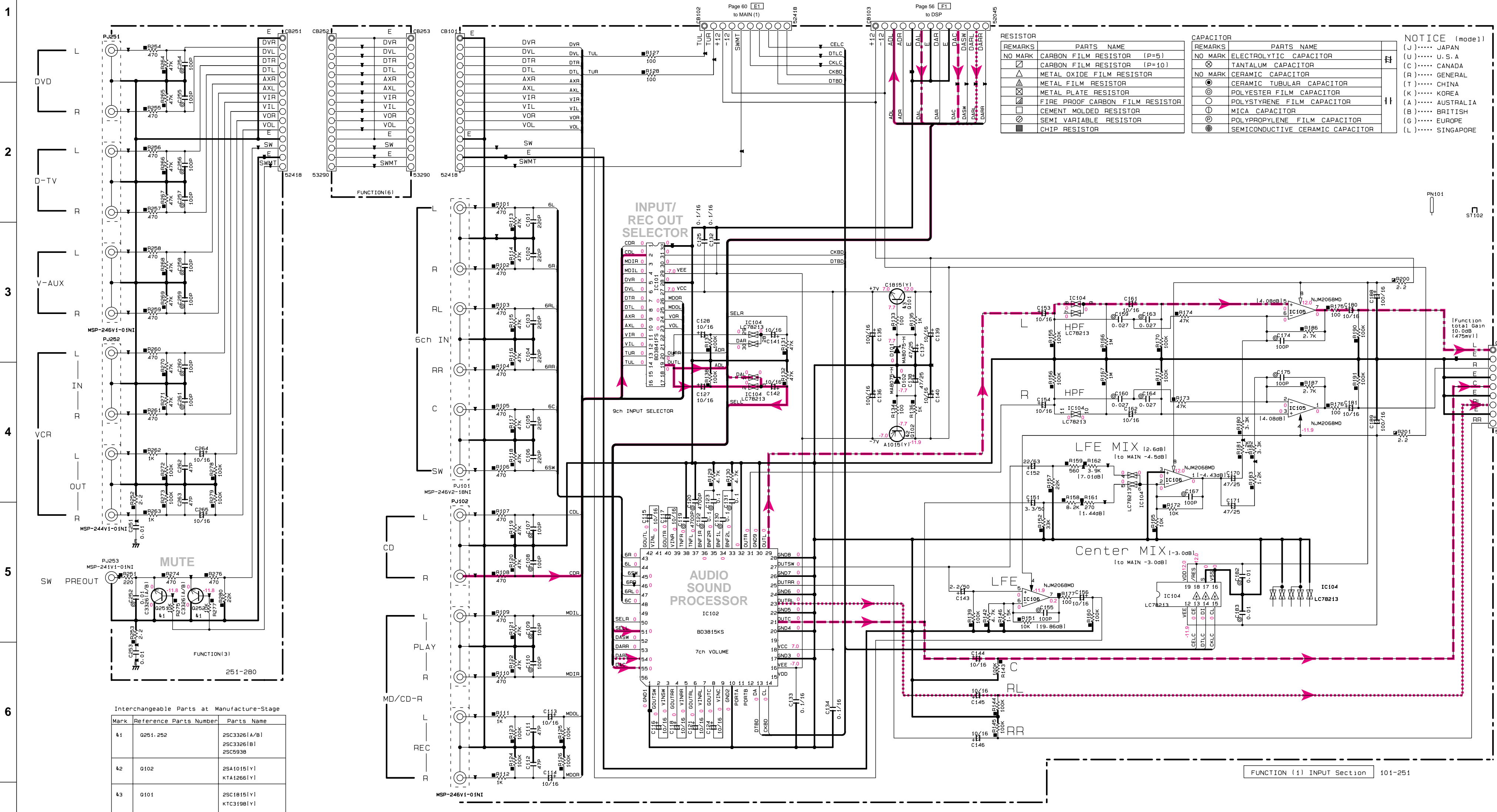

REMARKS	PARTS NAME	CAPACITOR	PARTS NAME
NO MARK	CARBON FILM RESISTOR (P=5)	NO MARK	ELECTROLYTIC CAPACITOR
□	CARBON FILM RESISTOR (P=10)	⊗	TANTALUM CAPACITOR
△	METAL OXIDE FILM RESISTOR	NO MARK	CERAMIC CAPACITOR
⊠	METAL FILM RESISTOR	⊙	CERAMIC TUBULAR CAPACITOR
⊞	METAL PLATE RESISTOR	⊖	POLYESTER FILM CAPACITOR
⊚	FIRE PROOF CARBON FILM RESISTOR	⊕	POLYSTYRENE FILM CAPACITOR
⊛	CEMENT MOLDED RESISTOR	Ⓜ	MICA CAPACITOR
Ⓜ	SEMI VARIABLE RESISTOR	Ⓜ	POLYPROPYLENE FILM CAPACITOR
Ⓜ	CHIP RESISTOR	Ⓜ	SEMICONDUCTIVE CERAMIC CAPACITOR

NOTICE (mode1)

(J)..... JAPAN
 (U)..... U.S.A
 (C)..... CANADA
 (R)..... GENERAL
 (T)..... CHINA
 (K)..... KOREA
 (A)..... AUSTRALIA
 (B)..... BRITISH
 (G)..... EUROPE
 (L)..... SINGAPORE

Interchangeable Parts at Manufacture-Stage

Mark	Reference Parts Number	Parts Name
k1	0261.252	25C33261A/B1 25C33261B1 25C5938
k2	0102	25A10151Y1 KT412561Y1
k3	0101	25C18151Y1 KTC31981Y1

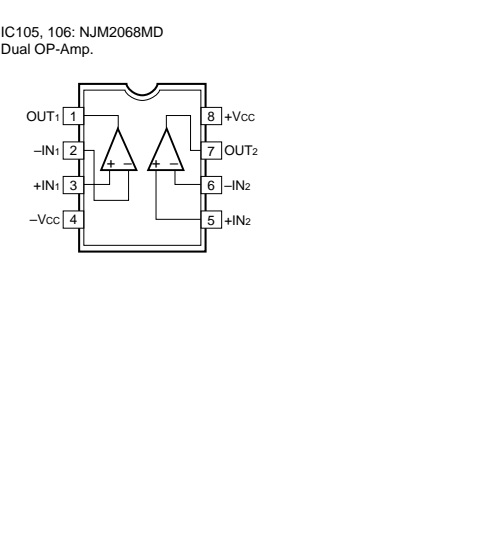
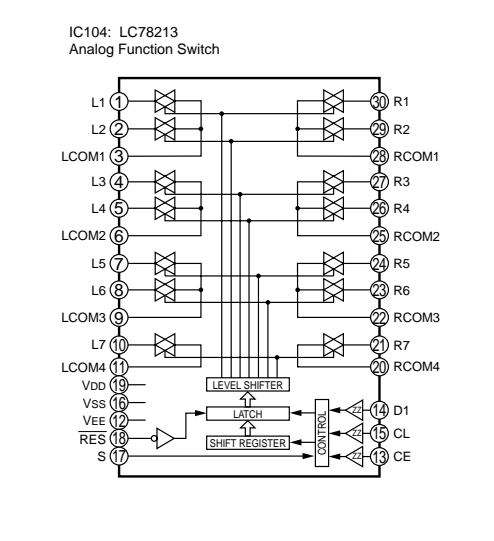
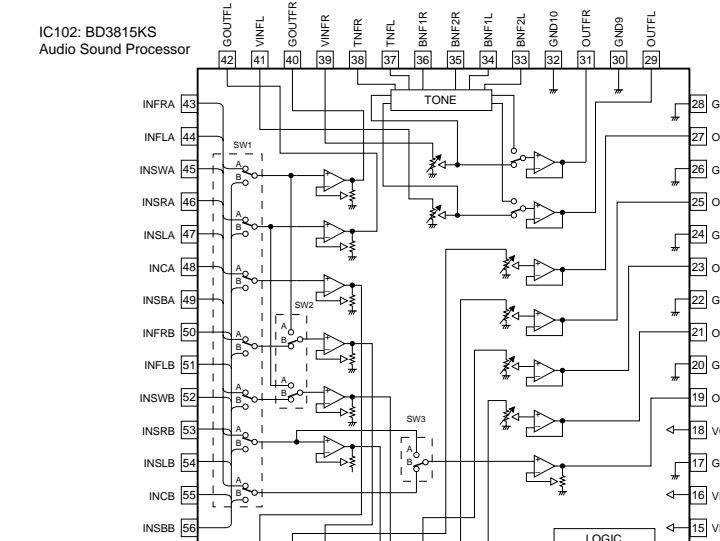
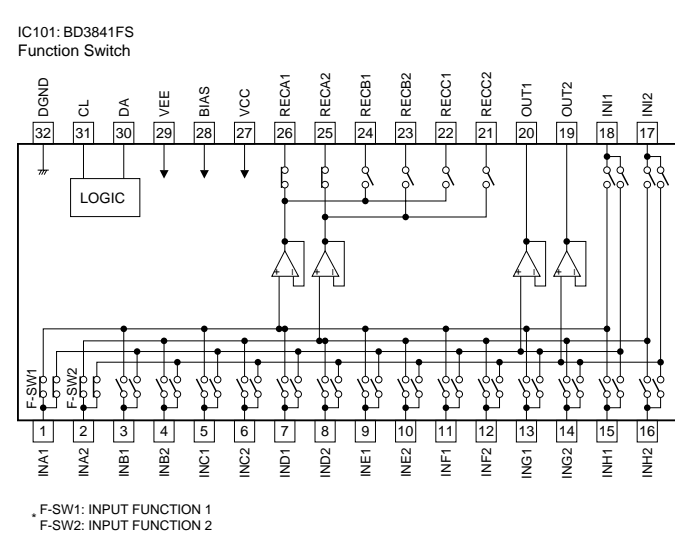

- * All voltages are measured with a 10MΩ/V DC electronic voltmeter.
 - * Components having special characteristics are marked with a triangle and must be replaced with parts having specifications equal to those originally installed.
 - * Schematic diagram is subject to change without notice.
- 電圧は、内部抵抗10MΩの電圧計で測定したものです。
 ● 印のある部品は、安全性確保部品を示しています。部品の交換が必要な場合、パーツリストに記載されている部品を使用してください。
 ● 本回路図は標準回路図です。改良のため予告なく変更することがございます。

SCHEMATIC DIAGRAM (FUNCTION 2/2)

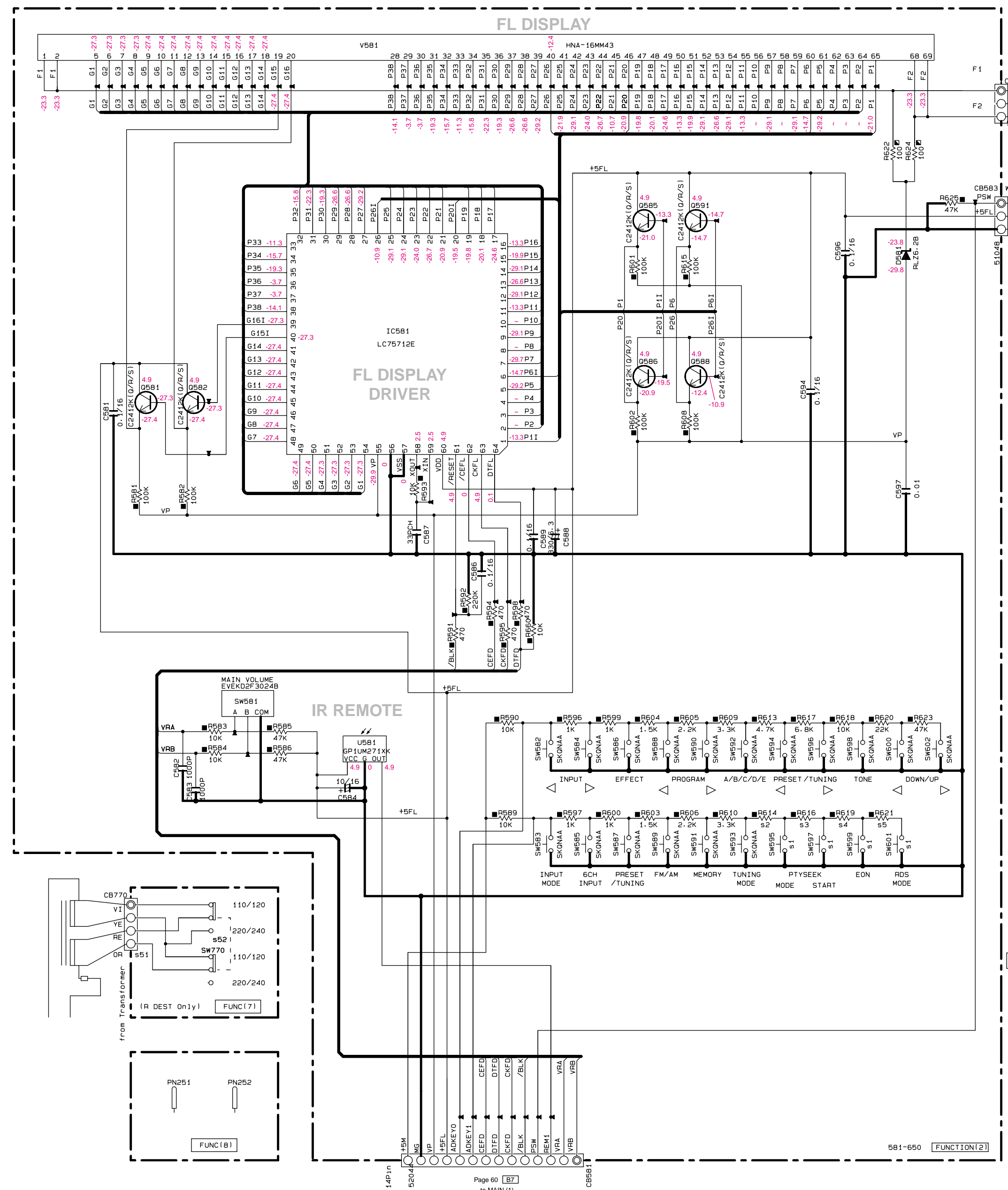

NO	REMARKS	PARTS NAME	J. U. C T. K. A. L.	R	B. G
s1		SW595-597-599-601	X	X	VV02030
s2		R614	X	X	4.7K RD35647
s3		R616	X	X	6.8K RD35668
s4		R619	X	X	10K RD35710
s5		R621	X	X	22K RD35722
s52		SW770	X		VZ07550 SL14-22AM5F X
s51		CB770	X		V937790 B4P7S-VH X

X: NOT USED
O: USED / APPLICABLE

REMARKS	PARTS NAME
NO MARK	CARBON FILM RESISTOR (P=5)
△	CARBON FILM RESISTOR (P=10)
□	METAL OXIDE FILM RESISTOR
▢	METAL FILM RESISTOR
⊠	METAL PLATE RESISTOR
⊞	FIRE PROOF CARBON FILM RESISTOR
⊞	CEMENT MOLDED RESISTOR
⊞	SEMI VARIABLE RESISTOR
⊞	CHIP RESISTOR

REMARKS	PARTS NAME
NO MARK	ELECTROLYTIC CAPACITOR
⊗	TANTALUM CAPACITOR
NO MARK	CERAMIC CAPACITOR
●	CERAMIC TUBULAR CAPACITOR
○	POLYESTER FILM CAPACITOR
⊖	POLYSTYRENE FILM CAPACITOR
⊖	POLYPROPYLENE FILM CAPACITOR
⊖	SEMICONDUCTIVE CERAMIC CAPACITOR
⊖	POLYPHENYLENE SULFIDE FILM CAPACITOR

Interchangeable Parts at Manufacture-Stage

Mark	Reference Parts Number	Parts Name
411	D651-652	KBP1036 RS103

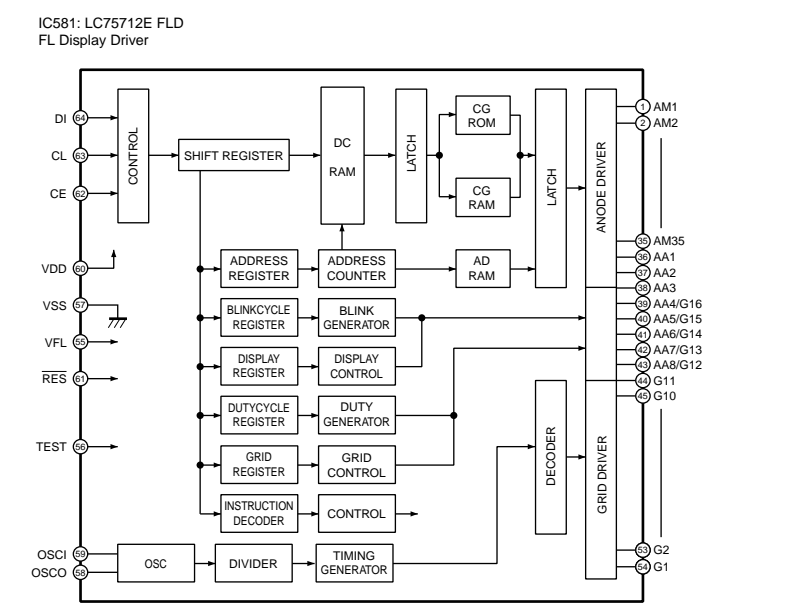

NOTICE (model)
(J)..... JAPAN
(U)..... U. S. A
(C)..... CANADA
(R)..... GENERAL
(T)..... CHINA
(K)..... KOREA
(A)..... AUSTRALIA
(B)..... BRITISH
(G)..... EUROPE
(L)..... SINGAPORE

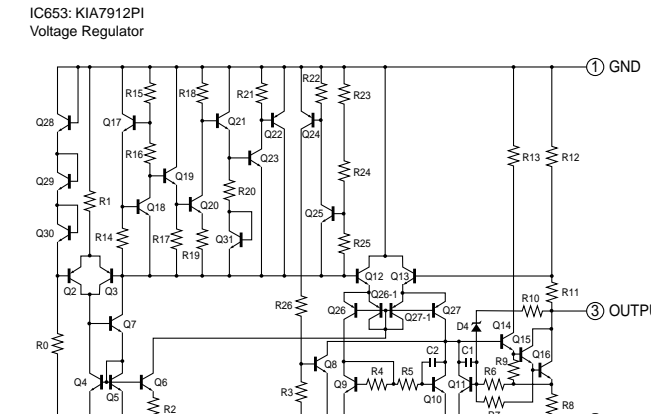
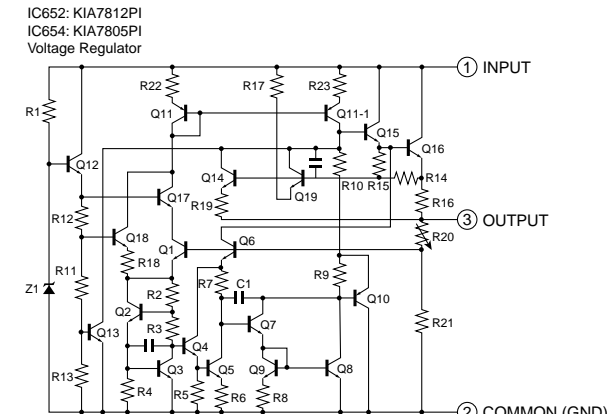
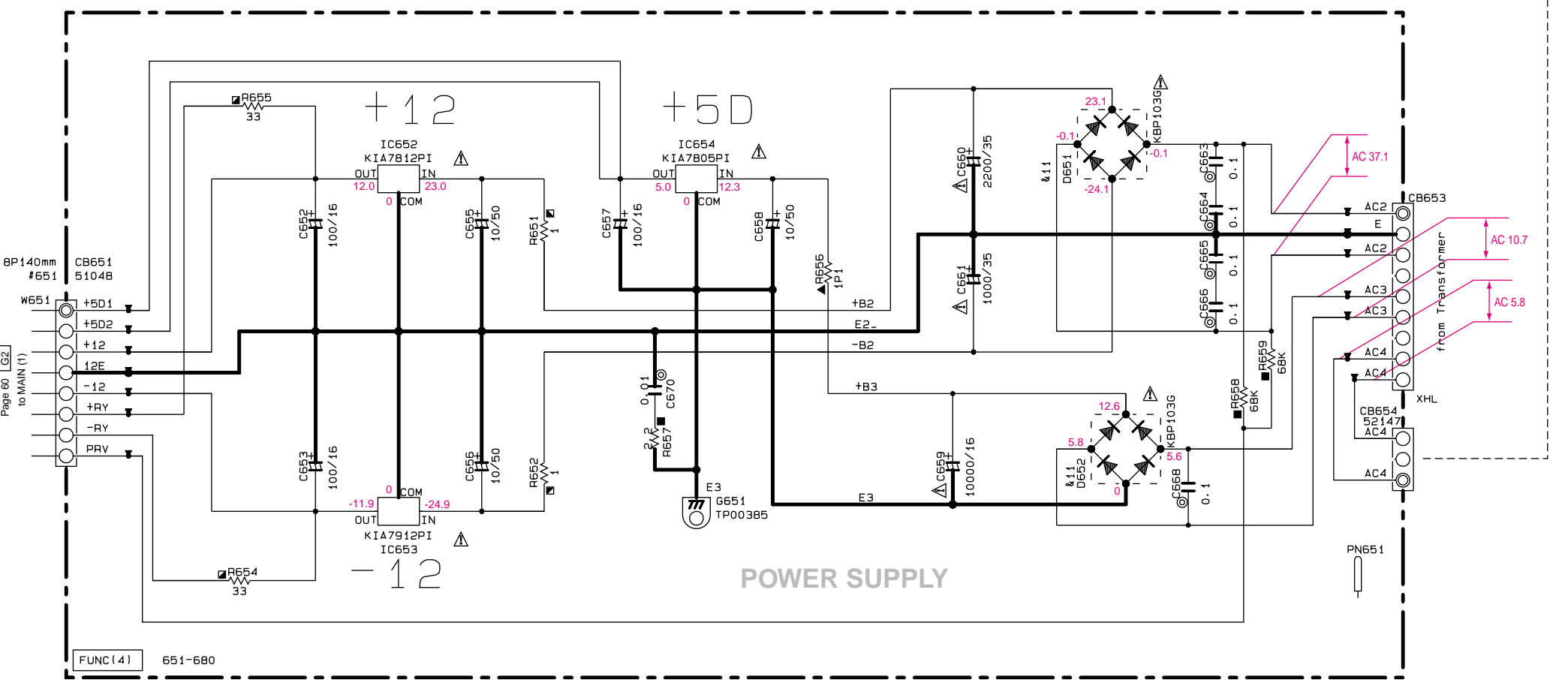

★ All voltages are measured with a 10MΩ/DC electronic voltmeter.
★ Components having special characteristics are marked with a triangle and must be replaced with parts having specifications equal to those originally installed.
★ Schematic diagram is subject to change without notice.
● 電圧は、内部抵抗10MΩの電圧計で測定したものです。
● △印のある部品は、安全性確保部品を示しています。部品の交換が必要な場合、パーツリストに記載されている部品を使用してください。
● 本回路図は標準回路図です。改良のため予告なく変更することがございます。

SCHEMATIC DIAGRAM (MAIN 1/2)

RX-V340/RX-V340RDS/HTR-5630/HTR-5630RDS/DSP-AX340

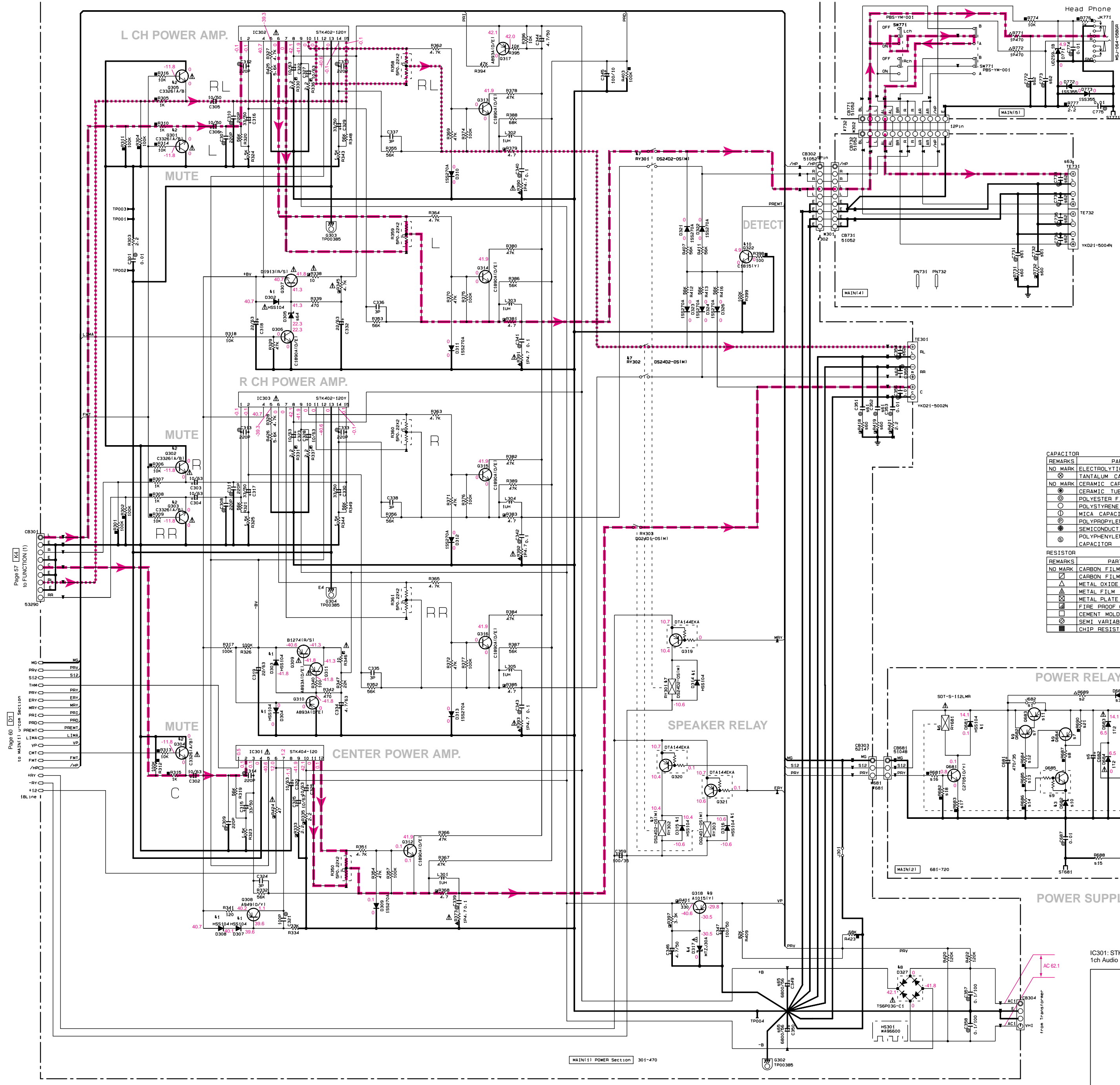

Part No.	QTY	U-C	R	T	A	K-L	B-G
S1 J682	0	0	X	0	0	0	0
S2 R699	X	X	X	0	X	X	X
S3 D685	X	X	112 V039780	X	X	X	X
S4 C683	0-01 UA65410	0-01 UA65410	X	0-01 UA65410	0-01 UA65410	0-01 UA65410	0-01 UA65410
S5 C684-685	X	X	0-01 UA65410	X	X	X	X
S6 C682	X	X	10/70 UR85710	X	X	X	X
S7 D682-684	X	X	A10151Y1 I410151	X	X	X	X
S8 R687	X	X	47K RD30747	X	X	X	X
S9 D680	X	X	DTC144E5 V087870	X	X	X	X
S10 D682	X	X	MTZJ4-7A V032700	X	X	X	X
S11 D683	X	X	A170815Y11 V072800	X	X	X	X
S12 R684	X	X	1K RD30510	X	X	X	X
S13 R685	X	X	33K RD35733	X	X	X	X
S14 R686	X	X	5.6K RD35656	X	X	X	X
S15 R688	X	X	1/250 2M V073000	X	X	X	X
S16 R681	4.7K RD35647	4.7K RD35647	1.8K RD35618	4.7K RD35647	4.7K RD35647	4.7K RD35647	4.7K RD35647
S17 R683	0 RD35600	15 RD35415	0 RD35600	0 RD35600	0 RD35600	0 RD35600	0 RD35600
S18 R682	100K RD35610	100K RD35610	560 RD35610	100K RD35610	100K RD35610	100K RD35610	100K RD35610
S19 F681	5A125V WB22110	5A125V WB22110	12-5AL250V VV07160	12-5AL250V VV07160	12-5AL250V VV07160	12-5AL250V VV07160	12-5AL250V VV07160
S20 T681	XW608 X4276	XW608 X4277	XW608 X4278	XW608 X4279	XW608 X4280	XW608 X4281	XW608 X4282
S21 R690	X	X	100K RD35610	X	X	X	X
S22 R418-419-731-732	X	X	2-2 HV75322	2-2 HV75322	2-2 HV75322	2-2 HV75322	2-2 HV75322
S23 C351-352-731-732	X	X	0-01 UA65410	0-01 UA65410	0-01 UA65410	0-01 UA65410	0-01 UA65410
S24 C354-355-733-732	X	X	0-01 X	0-01 X	0-01 X	0-01 X	0-01 X
S25 TE731	C-95414-06 -0201 Y156930	C-95414-06 -0201 Y156930	C-95414-06 -0201 Y156930	C-95414-06 -0201 Y156930	C-95414-06 -0201 Y156930	C-95414-06 -0201 Y156930	C-95414-06 -0201 Y156930
S26 C305	MTZJ02A V044200	MTZJ02A V044200	MTZJ02B V044170	MTZJ02B V044170	MTZJ02B V044170	MTZJ02B V044170	MTZJ02B V044170
S27 C349-350	WB22890	WB12150	WB12150	WB12150	WB12150	WB12150	WB22890

REMARKS: NO MARK ELECTROLYTIC CAPACITOR, NO MARK CERAMIC CAPACITOR, CERAMIC TUBULAR CAPACITOR, POLYESTER FILM CAPACITOR, POLYSTYRENE FILM CAPACITOR, MICA CAPACITOR, POLYPROPYLENE FILM CAPACITOR, SEMICONDUCTIVE CERAMIC CAPACITOR, POLYPHENYLENE SULFIDE FILM CAPACITOR

REMARKS: NO MARK CARBON FILM RESISTOR (P=5), CARBON FILM RESISTOR (P=10), METAL OXIDE FILM RESISTOR, METAL FILM RESISTOR, FINE PROOF CARBON FILM RESISTOR, CEMENT MOLDED RESISTOR, SEMI VARIABLE RESISTOR, CHIP RESISTOR

NOTICE (model): (J) JAPAN, (U) U.S.A, (C) CANADA, (R) GENERAL, (T) CHINA, (K) KOREA, (A) AUSTRALIA, (B) BRITISH, (G) EUROPE, (L) SINGAPORE

Interchangeable Parts at Manufacture-Stage

Mark	Reference Parts Number	Parts Name
41	0302-304, 307, 308, 314-316-681	H55104, I55133, I55176
42	0301-305	25C3381A/B, 25C3381B1, 25C5938
43	0682	MTZJ4-7A, GOZJ4-7A
44	0317	MTZJ30A, GOZJ30A
45		
46	R681	S07-5-112LNR, D01001-01M-11, ALK3321
47	R301-302	DS2402-051M, G0PA-28
48	0327	T56P035-C1, R6603M
49	0318, 0682-684	25A10151V1, *1412661V1
50	0322	25C18151V1, *1C31981V1
51		

Page 57 [LX] TO FUNCTION (1)
Page 68 [DT] to MAIN11 POWER SECTION

* All voltages are measured with a 10MΩ/V DC electronic voltmeter.
* Components having special characteristics are marked with a triangle and must be replaced with parts having specifications equal to those originally installed.
* Schematic diagram is subject to change without notice.

● 電圧は、内部抵抗10MΩの電圧計で測定したものです。
● 印のある部品は、安全性確保部品を示しています。部品の交換が必要な場合、パーツリストに記載されている部品を使用してください。
● 本回路図は標準回路図です。改良のため予告なく変更することがございます。

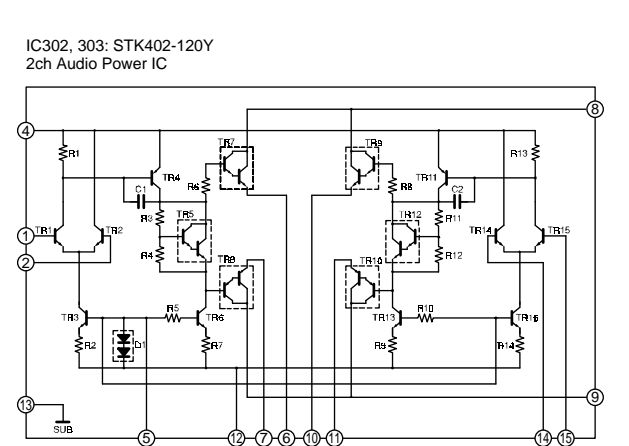
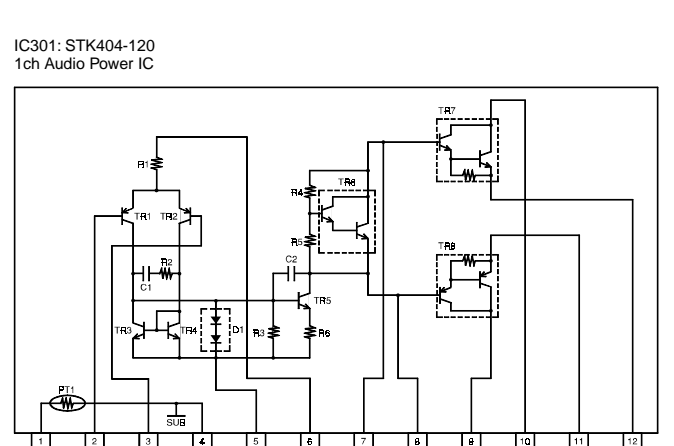

SCHEMATIC DIAGRAM (MAIN 2/2)

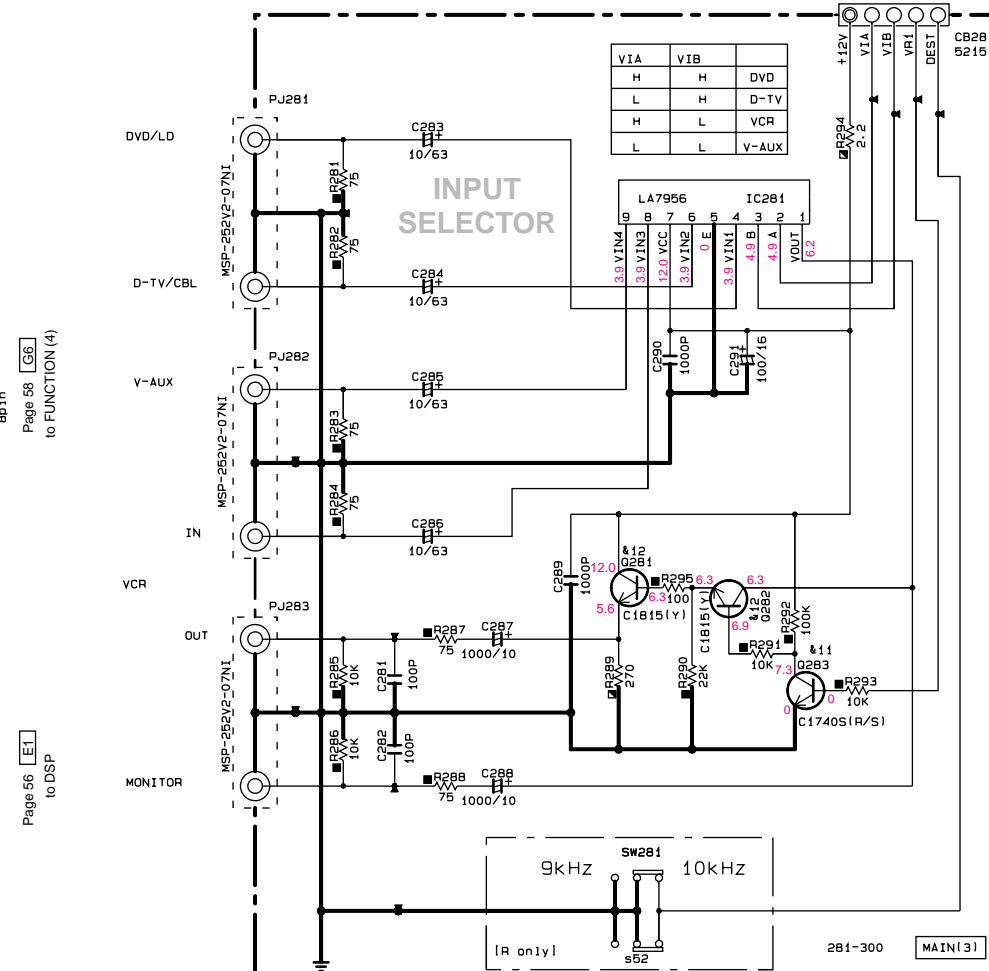
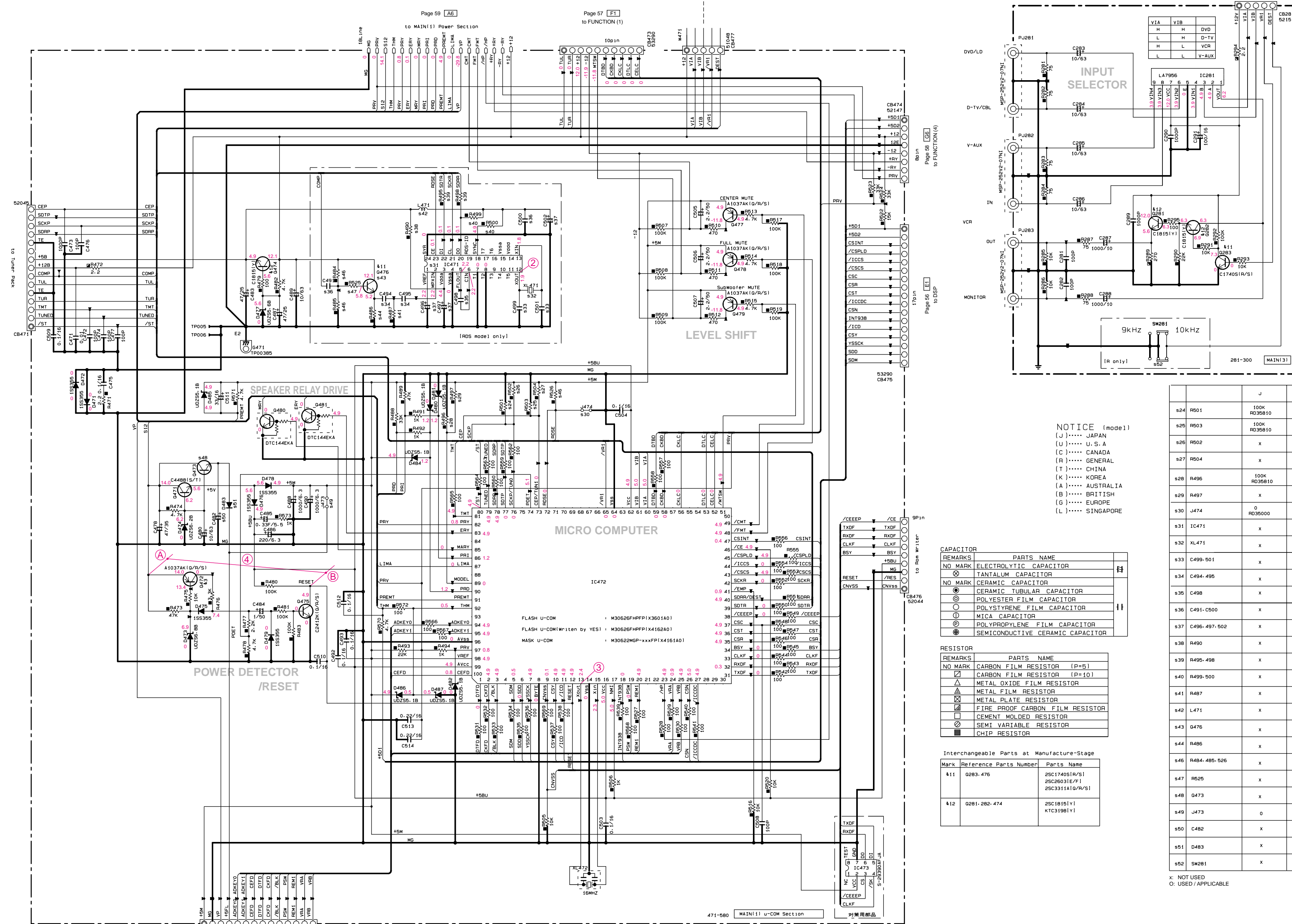

NOTICE (model)

(J)..... JAPAN
 (U)..... U. S. A
 (C)..... CANADA
 (R)..... GENERAL
 (T)..... CHINA
 (K)..... KOREA
 (A)..... AUSTRALIA
 (B)..... BRITISH
 (G)..... EUROPE
 (L)..... SINGAPORE

Part No.	Value	J	U-C	R	T	K-A-L	B-G
R501	100K RD35810		100K RD35810	X	X	X	X
R503	100K RD35810		X	X	100K RD35810	100K RD35810	100K RD35810
R502	X	X	100K RD35810	100K RD35810	100K RD35810	100K RD35810	100K RD35810
R504	X	100K RD35810	100K RD35810	X	X	X	X
R496	100K RD35810	100K RD35810	100K RD35810	X	100K RD35810	100K RD35810	100K RD35810
R497	X	X	X	X	100K RD35810	X	X
J474	0 RD35000	0 RD35000	0 RD35000	0 RD35000	0 RD35000	0 RD35000	X
IC471	X	X	X	X	X	X	LC72722 X1534A0
XL471	X	X	X	X	X	X	4.33MHz V393090
C499-501	X	X	X	X	X	X	27pH 1476110
C494-495	X	X	X	X	X	X	US06233
C498	X	X	X	X	X	X	560P US06266
C491-C500	X	X	X	X	X	X	0.1/16 US13510
C496-497-502	X	X	X	X	X	X	47/25 UR84747
R490	X	X	X	X	X	X	100 RD35510
R495-498	X	X	X	X	X	X	470 RD35547
R499-500	X	X	X	X	X	X	10K RD35710
R487	X	X	X	X	X	X	22K RD35722
L471	X	X	X	X	X	X	220uH VU89950
Q476	X	X	X	X	X	X	2SC174051R/S1 IC17402
R486	X	X	X	X	X	X	3.3K RD35633
R484-485-526	X	X	X	X	X	X	100K RD35810
R525	X	X	X	X	X	X	RD35610
Q473	X	X	C448B15/T1 VPB7270	X	X	X	X
J473	0	0	X	0	0	0	0
C482	X	X	10/63 UR87710	X	X	X	X
D483	X	X	1S5355 VT33290	X	X	X	X
SW281	X	X	S5029-P022M-JB V362430	X	X	X	X

CAPACITOR

REMARKS	PARTS NAME
NO MARK	ELECTROLYTIC CAPACITOR
⊗	TANTALUM CAPACITOR
NO MARK	CERAMIC CAPACITOR
○	CERAMIC TUBULAR CAPACITOR
⊙	POLYESTER FILM CAPACITOR
⊚	POLYSTYRENE FILM CAPACITOR
⊕	MICA CAPACITOR
⊖	POLYPROPYLENE FILM CAPACITOR
⊗	SEMICONDUCTIVE CERAMIC CAPACITOR

RESISTOR

REMARKS	PARTS NAME
NO MARK	CARBON FILM RESISTOR (P=5)
⊗	CARBON FILM RESISTOR (P=10)
⊕	METAL OXIDE FILM RESISTOR
⊖	METAL FILM RESISTOR
⊙	METAL PLATE RESISTOR
⊚	FIRE PROOF CARBON FILM RESISTOR
⊕	CEMENT MOLDED RESISTOR
⊖	SEMI VARIABLE RESISTOR
⊗	CHIP RESISTOR

Interchangeable Parts at Manufacture-Stage

Mark	Reference Parts Number	Parts Name
K11	0283-476	2SC174051R/S1 2SC26031E/F1 2SC33111G/R/S1
K12	0281-262-474	2SC18151V1 KTC31981V1

★ All voltages are measured with a 10MΩ/V DC electronic voltmeter.
 ★ Components having special characteristics are marked with a triangle and must be replaced with parts having specifications equal to those originally installed.
 ★ Schematic diagram is subject to change without notice.

● 電圧は、内部抵抗10MΩの電圧計で測定したものです。
 ● 印のある部品は、安全性確保部品を示しています。部品の交換が必要な場合、パーツリストに記載されている部品を使用してください。
 ● 本回路図は標準回路図です。改良のため予告なく変更することがございます。

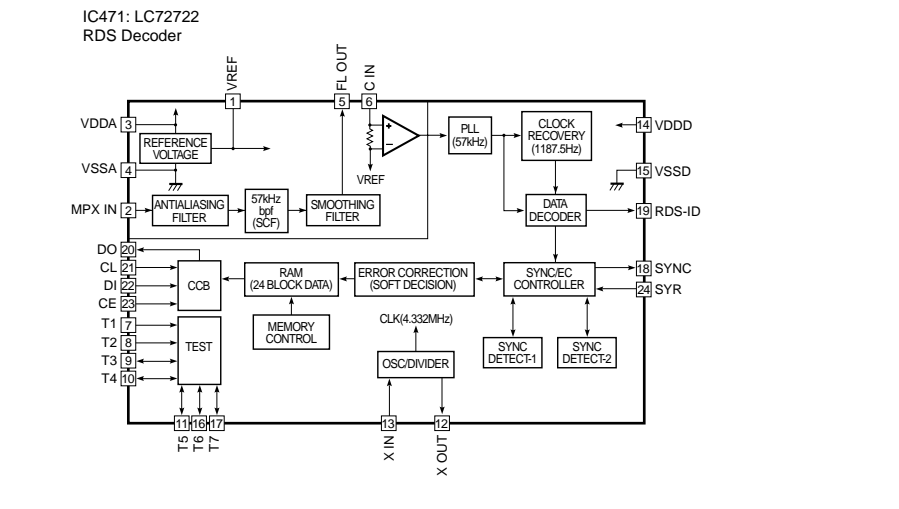
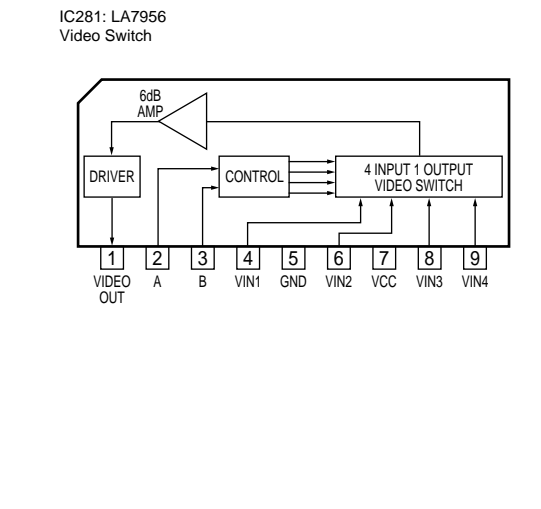
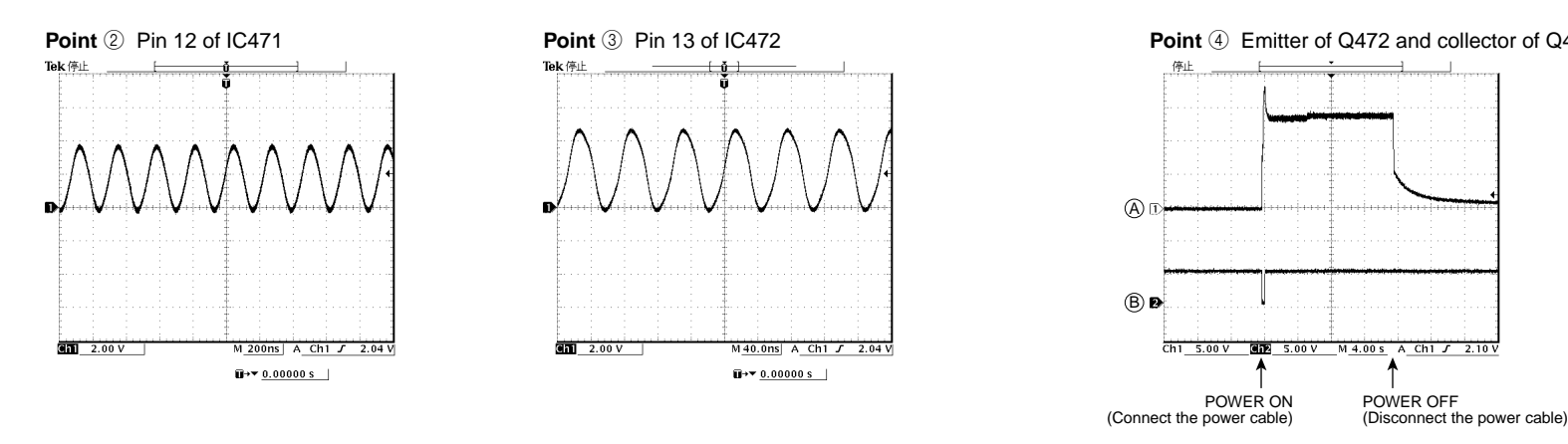

PARTS LIST

■ ELECTRICAL PARTS

■ WARNING

● Components having special characteristics are marked \triangle and must be replaced with parts having specifications equal to those originally installed.

● \triangle 印のある部分は、安全確保部品を示しています。部品の交換が必要な場合、パーツリストに記載されている部品を使用してください。

● 部品価格ランクは、予告なく変更することがあります。

ABBREVIATIONS IN THIS LIST ARE AS FOLLOWS:

C.A.EL.CHP	: CHIP ALUMI.ELECTROLYTIC CAP	L.EMIT	: LIGHT EMITTING MODULE
C.CE	: CERAMIC CAP	LED.DSPLY	: LED DISPLAY
C.CE.ARRAY	: CERAMIC CAP ARRAY	LED.INFRD	: LED,INFRARED
C.CE.CHP	: CHIP CERAMIC CAP	MODUL.RF	: MODULATOR,RF
C.CE.ML	: MULTILAYER CERAMIC CAP	PHOT.CPL	: PHOTO COUPLER
C.CE.M.CHP	: CHIP MULTILAYER CERAMIC CAP	PHOT.INTR	: PHOTO INTERRUPTER
C.CE.SAFTY	: RECOGNIZED CERAMIC CAP	PHOT.RFLCT	: PHOTO REFLECTOR
C.CE.TUBLR	: CERAMIC TUBULAR CAP	PIN.TEST	: PIN,TEST POINT
C.CE.SMI	: SEMI CONDUCTIVE CERAMIC CAP	PLST.RIVET	: PLASTIC RIVET
C.EL	: ELECTROLYTIC CAP	R.ARRAY	: RESISTOR ARRAY
C.MICA	: MICA CAP	R.CAR.	: CARBON RESISTOR
C.ML.FLM	: MULTILAYER FILM CAP	R.CAR.CHP	: CHIP RESISTOR
C.MP	: METALLIZED PAPER CAP	R.CAR.FP	: FLAME PROOF CARBON RESISTOR
C.MYLAR	: MYLAR FILM CAP	R.FUS	: FUSABLE RESISTOR
C.MYLAR.ML	: MULTILAYER MYLAR FILM CAP	R.MTL.CHP	: CHIP METAL FILM RESISTOR
C.PAPER	: PAPER CAPACITOR	R.MTL.FLM	: METAL FILM RESISTOR
C.PLS	: POLYSTYRENE FILM CAP	R.MTL.OXD	: METAL OXIDE FILM RESISTOR
C.POL	: POLYESTER FILM CAP	R.MTL.PLAT	: METAL PLATE RESISTOR
C.POLY	: POLYETHYLENE FILM CAP	RSNR.CE	: CERAMIC RESONATOR
C.PP	: POLYPROPYLENE FILM CAP	RSNR.CRYS	: CRYSTAL RESONATOR
C.TNTL	: TANTALUM CAP	R.TW.CEM	: TWIN CEMENT FIXED RESISTOR
C.TNTL.CHP	: CHIP TANTALUM CAP	R.WW	: WIRE WOUND RESISTOR
C.TRIM	: TRIMMER CAP	SCR.BND.HD	: BIND HEAD B-TITE SCREW
CN	: CONNECTOR	SCR.BW.HD	: BW HEAD TAPPING SCREW
CN.BS.PIN	: CONNECTOR,BASE PIN	SCR.CUP	: CUP TITE SCREW
CN.CANNON	: CONNECTOR,CANNON	SCR.TERM	: SCREW TERMINAL
CN.DIN	: CONNECTOR,DIN	SCR.TR	: SCREW,TRANSISTOR
CN.FLAT	: CONNECTOR,FLAT CABLE	SUPRT.PCB	: SUPPORT,P.C.B.
CN.POST	: CONNECTOR,BASE POST	SURG.PRTCT	: SURGE PROTECTOR
COIL.MX.AM	: COIL,AM MIX	SW.TACT	: TACT SWITCH
COIL.AT.FM	: COIL,FM ANTENNA	SW.LEAF	: LEAF SWITCH
COIL.DT.FM	: COIL,FM DETECT	SW.LEVER	: LEVER SWITCH
COIL.MX.FM	: COIL,FM MIX	SW.MICRO	: MICRO SWITCH
COIL.OUTPT	: OUTPUT COIL	SW.PUSH	: PUSH SWITCH
DIOD.ARRAY	: DIODE ARRAY	SW.RT.ENC	: ROTARY ENCODER
DIODE.BRG	: DIODE BRIDGE	SW.RT.MTR	: ROTARY SWITCH WITH MOTOR
DIODE.CHP	: CHIP DIODE	SW.RT	: ROTARY SWITCH
DIODE.VAR	: VARACTOR DIODE	SW.SLIDE	: SLIDE SWITCH
DIOD.Z.CHP	: CHIP ZENER DIODE	TERM.SP	: SPEAKER TERMINAL
DIODE.ZENR	: ZENER DIODE	TERM.WRAP	: WRAPPING TERMINAL
DSCR.CE	: CERAMIC DISCRIMINATOR	THRMST.CHP	: CHIP THERMISTOR
FER.BEAD	: FERRITE BEADS	TR.CHP	: CHIP TRANSISTOR
FER.CORE	: FERRITE CORE	TR.DGT	: DIGITAL TRANSISTOR
FET.CHP	: CHIP FET	TR.DGT.CHP	: CHIP DIGITAL TRANSISTOR
FL.DSPLY	: FLUORESCENT DISPLAY	TRANS	: TRANSFORMER
FLTR.CE	: CERAMIC FILTER	TRANS.PULS	: PULSE TRANSFORMER
FLTR.COMB	: COMB FILTER MODULE	TRANS.PWR	: POWER TRANSFORMER ASS'Y
FLTR.LC.RF	: LC FILTER,EMI	TUNER.AM	: TUNER PACK,AM
GND.MTL	: GROUND PLATE	TUNER.FM	: TUNER PACK,FM
GND.TERM	: GROUND TERMINAL	TUNER.PK	: FRONT-ENDTUNER PACK
HOLDER.FUS	: FUSE HOLDER	VR	: ROTARY POTENTIOMETER
IC.PRTCT	: IC PROTECTOR	VR.MTR	: POTENTIOMETER WITH MOTOR
JUMPER.CN	: JUMPER CONNECTOR	VR.SW	: POTENTIOMETER WITH ROTARY SW
JUMPER.TST	: JUMPER,TEST POINT	VR.SLIDE	: SLIDE POTENTIOMETER
L.DTCT	: LIGHT DETECTING MODULE	VR.TRIM	: TRIMMER POTENTIOMETER

Note) Those parts marked with “#” are not included in the P.C.B. ass'y.

P.C.B. DSP

*
*

Schm Ref.	PART NO.	Description	Remarks	Markets	部 品 名	Rank
	WB139200	P. C. B.	DSP		P C B D S P	
	WB139300	P. C. B.	DSP		P C B D S P	
CB802	VQ962000	CN. BS. PIN	17P		ハウジング	
CB803	VQ044600	CN. BS. PIN	13P		F F Cコネクター	
C801	US061220	C. CE. M. CHP	22pF 50V		チップセラコン	
C802	US135100	C. CE. CHP	0. 1uF 16V		チップセラコン	
C803	US135100	C. CE. CHP	0. 1uF 16V		チップセラコン	
C804	UR847220	C. EL	22uF 25V		ケミコン	
C805	US061100	C. CE. M. CHP	10pF 50V		チップセラコン	
C806	US135100	C. CE. CHP	0. 1uF 16V	J	チップセラコン	
C807	UR818100	C. EL	100uF 6. 3V	J	ケミコン	01
C808	US062220	C. CE. CHP	220pF 50V		チップセラコン	
C809	US063100	C. CE. M. CHP	1000pF 50V		チップセラコン	
C810	UR818100	C. EL	100uF 6. 3V	J	ケミコン	01
C811	UR818100	C. EL	100uF 6. 3V	J	ケミコン	01
C812	US135100	C. CE. CHP	0. 1uF 16V	J	チップセラコン	
C813	US062100	C. CE. M. CHP	100pF 50V	J	チップセラコン	
C814	US135100	C. CE. CHP	0. 1uF 16V	J	チップセラコン	
C815	UR819100	C. EL	1000uF 6. 3V		ケミコン	01
C816	US135100	C. CE. CHP	0. 1uF 16V		チップセラコン	
C817	US135100	C. CE. CHP	0. 1uF 16V		チップセラコン	
C818	US135100	C. CE. CHP	0. 1uF 16V		チップセラコン	
C819	US135100	C. CE. CHP	0. 1uF 16V		チップセラコン	
C820	US135100	C. CE. CHP	0. 1uF 16V		チップセラコン	
C821	UR829100	C. EL	1000uF 10V		ケミコン	
C822	UR818100	C. EL	100uF 6. 3V	J	ケミコン	01
C823	UR819100	C. EL	1000uF 6. 3V		ケミコン	01
C824	US135100	C. CE. CHP	0. 1uF 16V	J	チップセラコン	
C825	US135100	C. CE. CHP	0. 1uF 16V		チップセラコン	
C826	UR818100	C. EL	100uF 6. 3V		ケミコン	01
C827	UR819100	C. EL	1000uF 6. 3V		ケミコン	01
C828	US135100	C. CE. CHP	0. 1uF 16V		チップセラコン	
C829	US135100	C. CE. CHP	0. 1uF 16V		チップセラコン	
C830	US135100	C. CE. CHP	0. 1uF 16V		チップセラコン	
C831	US135100	C. CE. CHP	0. 1uF 16V		チップセラコン	
C832	UR818470	C. EL	470uF 6. 3V		ケミコン	
C833	UR818100	C. EL	100uF 6. 3V		ケミコン	01
C834	US135100	C. CE. CHP	0. 1uF 16V		チップセラコン	
C835	US061180	C. CE. CHP	18pF 50V		チップセラコン	
C836	US135100	C. CE. CHP	0. 1uF 16V		チップセラコン	
C837	US061180	C. CE. CHP	18pF 50V		チップセラコン	
C838	US135100	C. CE. CHP	0. 1uF 16V		チップセラコン	
C839	UR818470	C. EL	470uF 6. 3V		ケミコン	
C840	US062470	C. CE. M. CHP	470pF 50V		チップセラコン	
C841	US135100	C. CE. CHP	0. 1uF 16V		チップセラコン	
C842	US135100	C. CE. CHP	0. 1uF 16V	J	チップセラコン	
C843	UR818100	C. EL	100uF 6. 3V	J	ケミコン	01
C844	US061470	C. CE. M. CHP	47pF 50V	J	チップセラコン	
C845	US061470	C. CE. M. CHP	47pF 50V	J	チップセラコン	
C846	US061470	C. CE. M. CHP	47pF 50V	J	チップセラコン	
C847	US061470	C. CE. M. CHP	47pF 50V		チップセラコン	
C848	US135100	C. CE. CHP	0. 1uF 16V		チップセラコン	
C849	US135100	C. CE. CHP	0. 1uF 16V	J	チップセラコン	

* New Parts * 新規部品(マーク#の部品は、基板に含まれません)

RX-V340/RX-V340RDS/
HTR-5630/HTR-5630RDS/DSP-AX340

P.C.B. DSP

Schm Ref.	PART NO.	Description	Remarks	Markets	部 品 名	Rank	
C850	US061470	C. CE. M. CHP	47pF 50V		J	チップセラコン	
C851	US061470	C. CE. M. CHP	47pF 50V		J	チップセラコン	
C852	US061470	C. CE. M. CHP	47pF 50V			チップセラコン	
C853	UR818100	C. EL	100uF 6.3V			ケミコン	01
C854	US135100	C. CE. CHP	0.1uF 16V			チップセラコン	
C855	US135100	C. CE. CHP	0.1uF 16V			チップセラコン	
C856	US063470	C. CE. CHP	4700pF 50V			チップセラコン	
C857	US135100	C. CE. CHP	0.1uF 16V		J	チップセラコン	
C858	US135100	C. CE. CHP	0.1uF 16V		J	チップセラコン	
C859	UR818100	C. EL	100uF 6.3V		J	ケミコン	01
C860	US135100	C. CE. CHP	0.1uF 16V			チップセラコン	
C861	UR818100	C. EL	100uF 6.3V		J	ケミコン	01
C862	UR818100	C. EL	100uF 6.3V		J	ケミコン	01
C863	US135100	C. CE. CHP	0.1uF 16V		J	チップセラコン	
C864	US063470	C. CE. CHP	4700pF 50V			チップセラコン	
C865	UR818100	C. EL	100uF 6.3V			ケミコン	01
C866	US135100	C. CE. CHP	0.1uF 16V			チップセラコン	
C867	US061470	C. CE. M. CHP	47pF 50V		J	チップセラコン	
C868	US135100	C. CE. CHP	0.1uF 16V			チップセラコン	
C869	US061470	C. CE. M. CHP	47pF 50V		J	チップセラコン	
C870	US135100	C. CE. CHP	0.1uF 16V		J	チップセラコン	
C871	US135100	C. CE. CHP	0.1uF 16V		J	チップセラコン	
C872	UR817470	C. EL	47uF 6.3V		J	ケミコン	
C873	UR866220	C. EL	2.2uF 50V		J	ケミコン	
C874	UR818100	C. EL	100uF 6.3V		J	ケミコン	01
C875	UR818100	C. EL	100uF 6.3V		J	ケミコン	01
C876	UR818100	C. EL	100uF 6.3V			ケミコン	01
C877	US135100	C. CE. CHP	0.1uF 16V			チップセラコン	
C878	US061470	C. CE. M. CHP	47pF 50V		J	チップセラコン	
C879	UR819100	C. EL	1000uF 6.3V			ケミコン	01
C880	US135100	C. CE. CHP	0.1uF 16V			チップセラコン	
C881	US064100	C. CE. M. CHP	0.01uF 50V		J	チップセラコン	
C882	US062470	C. CE. M. CHP	470pF 50V		J	チップセラコン	
C883	US135100	C. CE. CHP	0.1uF 16V			チップセラコン	
C884	UR819100	C. EL	1000uF 6.3V			ケミコン	01
C885	US135100	C. CE. CHP	0.1uF 16V		J	チップセラコン	
C886	UR818100	C. EL	100uF 6.3V		J	ケミコン	01
C887	US135100	C. CE. CHP	0.1uF 16V			チップセラコン	
C888	US061470	C. CE. M. CHP	47pF 50V			チップセラコン	
C889	US061470	C. CE. M. CHP	47pF 50V			チップセラコン	
C890	US061470	C. CE. M. CHP	47pF 50V			チップセラコン	
C891	US061470	C. CE. M. CHP	47pF 50V			チップセラコン	
C892	US135100	C. CE. CHP	0.1uF 16V			チップセラコン	
C893	US135100	C. CE. CHP	0.1uF 16V			チップセラコン	
C894	US061470	C. CE. M. CHP	47pF 50V			チップセラコン	
C895	US061470	C. CE. M. CHP	47pF 50V			チップセラコン	
C896	US061470	C. CE. M. CHP	47pF 50V			チップセラコン	
C897	US061470	C. CE. M. CHP	47pF 50V			チップセラコン	
C898	US135100	C. CE. CHP	0.1uF 16V			チップセラコン	
C900	US135100	C. CE. CHP	0.1uF 16V			チップセラコン	
C901	US135100	C. CE. CHP	0.1uF 16V			チップセラコン	
C902	US135100	C. CE. CHP	0.1uF 16V			チップセラコン	
C903	UR818100	C. EL	100uF 6.3V			ケミコン	01

* New Parts * 新規部品(マーク#の部品は、基板に含まれません)

P.C.B. DSP

Schm Ref.	PART NO.	Description	Remarks	Markets	部 品 名	Rank
C904	UR818100	C. EL	100uF 6.3V		ケミコン	01
C905	US135100	C. CE. CHP	0.1uF 16V		チップセラコン	
C906	US135100	C. CE. CHP	0.1uF 16V		チップセラコン	
C907	UR828100	C. EL	100uF 10V		ケミコン	01
C908	US135100	C. CE. CHP	0.1uF 16V		チップセラコン	
C909	UR866220	C. EL	2.2uF 50V		ケミコン	
C910	UR877100	C. EL	10uF 63V		ケミコン	
C911	UR877100	C. EL	10uF 63V		ケミコン	
C912	UR847100	C. EL	10uF 25V		ケミコン	
C913	UR877100	C. EL	10uF 63V		ケミコン	
C914	UR877100	C. EL	10uF 63V		ケミコン	
C915	UR877100	C. EL	10uF 63V		ケミコン	
C916	UR877100	C. EL	10uF 63V		ケミコン	
C917	UR847100	C. EL	10uF 25V		ケミコン	
C918	UA652470	C. MYLAR	470pF 50V		マイラーコン	01
C919	UA652470	C. MYLAR	470pF 50V		マイラーコン	01
C920	UA652470	C. MYLAR	470pF 50V		マイラーコン	01
C921	UA653390	C. MYLAR	3900pF 50V		マイラーコン	
C922	UA652470	C. MYLAR	470pF 50V		マイラーコン	01
C923	UA652470	C. MYLAR	470pF 50V		マイラーコン	01
C924	UR877100	C. EL	10uF 63V		ケミコン	
C925	UR877100	C. EL	10uF 63V		ケミコン	
C926	UR877100	C. EL	10uF 63V		ケミコン	
C927	UR877100	C. EL	10uF 63V		ケミコン	
C928	UR877100	C. EL	10uF 63V		ケミコン	
C929	UR877100	C. EL	10uF 63V		ケミコン	
C930	UR858100	C. EL	100uF 35V		ケミコン	
C931	UR858100	C. EL	100uF 35V		ケミコン	
C932	UR858100	C. EL	100uF 35V		ケミコン	
C933	UR858100	C. EL	100uF 35V		ケミコン	
C934	UR858100	C. EL	100uF 35V		ケミコン	
C935	UR858100	C. EL	100uF 35V		ケミコン	
C936	US135100	C. CE. CHP	0.1uF 16V		チップセラコン	
C937	US135100	C. CE. CHP	0.1uF 16V		チップセラコン	
C938	US135100	C. CE. CHP	0.1uF 16V		チップセラコン	
C939	US135100	C. CE. CHP	0.1uF 16V		チップセラコン	
C940	US135100	C. CE. CHP	0.1uF 16V		チップセラコン	
C941	US135100	C. CE. CHP	0.1uF 16V		チップセラコン	
C942	US061470	C. CE. M. CHP	47pF 50V	J	チップセラコン	
C943	US061470	C. CE. M. CHP	47pF 50V		チップセラコン	
C944	US061470	C. CE. M. CHP	47pF 50V		チップセラコン	
C945	US061470	C. CE. M. CHP	47pF 50V		チップセラコン	
C946	US061470	C. CE. M. CHP	47pF 50V		チップセラコン	
C947	UA654470	C. MYLAR	0.047uF 50V		マイラーコン	01
C948	US061100	C. CE. M. CHP	10pF 50V	J	チップセラコン	
D801	VT332900	D10DE	1SS355		ダイオード	
D802	VT332900	D10DE	1SS355		ダイオード	
D803	VT332900	D10DE	1SS355		ダイオード	
D804	VT332900	D10DE	1SS355		ダイオード	
D805	VT332900	D10DE	1SS355		ダイオード	
D806	VT332900	D10DE	1SS355		ダイオード	
D807	WB081800	D10DE	SB01-050		ショットキダイオード	
D808	WB081800	D10DE	SB01-050		ショットキダイオード	

* New Parts * 新規部品(マーク#の部品は、基板に含まれません)

P.C.B. DSP & P.C.B. FUNCTION

Schm Ref.	PART NO.	Description	Remarks	Markets	部 品 名	Rank	
* *	D809	WB081800	D10DE	SB01-05Q		ショットキダイオード	
	D810	WB081800	D10DE	SB01-05Q		ショットキダイオード	
	IC801	XV077B00	IC	MSM514260E-60JS		メモリ IC 4M	
	IC802	X4075A00	IC	XC9572XL-10Q100C	J	IC	
	IC803	X0238B00	IC	YSS938		IC	
	IC804	XU965A00	IC	uPC29M33T-E1 3.3V		電源IC	
	IC805	X3473A00	IC	CS493292-CLR	J	IC	
	IC806	X3820A00	IC	AK4529VQ		IC	
	IC807	XY070A00	IC	MM74HCU04SJX INVER		ロジックIC SOP	
	IC808	XZ012A00	IC	TC74HCT08AF(EL)		ロジックIC SOP	01
	IC809	X3505A00	IC	NJM2068MD-TE2		アンプIC SOP	
	IC810	X3505A00	IC	NJM2068MD-TE2		アンプIC SOP	
	IC811	X3505A00	IC	NJM2068MD-TE2		アンプIC SOP	
	IC812	XZ003A00	IC	PQ025EZ5MZP 2.5V		電源IC QFP	
	IC813	X4318A00	IC	CY62556LL70SNCT	J	メモリIC 256K	
	L801	V2726500	COIL	68uH		コイル	
	L802	V4769500	FER. BEAD	RH03506BT-B-1B	UCRTKABGL	フェライトビーズ	
	L802	V4769500	FER. BEAD	RH03506BT-B-1B		フェライトビーズ	
	L803	V4769500	FER. BEAD	RH03506BT-B-1B		フェライトビーズ	
	L803	V4769500	FER. BEAD	RH03506BT-B-1B	UCRTKABGL	フェライトビーズ	
	PJ801	V4483900	JACK. PIN	YKC21-3895		ピンジャック 1P	
	R806	HV753220	R. CAR. FP	2.2Ω 1/4W	J	不燃化カーボン抵抗	01
	R807	HV753220	R. CAR. FP	2.2Ω 1/4W		不燃化カーボン抵抗	01
	R866	HV753220	R. CAR. FP	2.2Ω 1/4W	J	不燃化カーボン抵抗	01
	R890	HV753220	R. CAR. FP	2.2Ω 1/4W		不燃化カーボン抵抗	01
	R900	HV753100	R. CAR. FP	1Ω 1/4W		不燃化カーボン抵抗	
	R901	HV753100	R. CAR. FP	1Ω 1/4W		不燃化カーボン抵抗	
	R906	VU224000	R. MTL. FLM	0.22Ω 1W		金属被膜抵抗	
	R907	HV753220	R. CAR. FP	2.2Ω 1/4W		不燃化カーボン抵抗	01
	R910	HV753220	R. CAR. FP	2.2Ω 1/4W		不燃化カーボン抵抗	01
	U801	V5478200	CN. PHOT. SN	1P GP1FA551RZ		光ファイバ受信器	
	XL801	V3625700	RSNR. CRYST	24.576MHz		水晶振動子	
* * *		WB138900	P. C. B.	FUNCTION	JUCTKAL	P C B ファンクション	
		WB139000	P. C. B.	FUNCTION	R	P C B ファンクション	
		WB139100	P. C. B.	FUNCTION	BG	P C B ファンクション	
	CB101	VQ961800	CN. BS. PIN	15P		ハウジング	
	CB102	VQ961300	CN. BS. PIN	10P		ハウジング	
	CB103	VM923600	CN. BS. PIN	13P		FFCコネクタ	01
	CB104	VQ961200	CN. BS. PIN	9P		ハウジング	
	CB251	VQ961800	CN. BS. PIN	15P		ハウジング	
	CB252	VQ963600	CN. BS. PIN	15P		ウエハー	
	CB253	VQ963600	CN. BS. PIN	15P		ウエハー	
	CB581	VF982200	CN. BS. PIN	14P		コネクタ	
	CB582	Vi878100	CN. BS. PIN	3P		ケーブルホルダー	01
	CB583	Vi878100	CN. BS. PIN	3P		ケーブルホルダー	01
	CB584	Vi878100	CN. BS. PIN	3P		ケーブルホルダー	01
	CB651	Vi878600	CN. BS. PIN	8P		ケーブルホルダー	04
* *	CB653	LB919090	CN. BS. PIN	9P		ベースツキポスト	
	CB654	VK024700	CN. BS. PIN	3P		ワイヤートラップ	01
	CB770	V9377900	CN. BS. PIN	4P SE VH SERIES	R	ベース付ポスト	

* New Parts * 新規部品(マーク#の部品は、基板に含まれません)

P.C.B. FUNCTION

Schm Ref.	PART NO.	Description	Remarks	Markets	部 品 名	Rank	
C101	US062220	C. CE. CHP	220pF	50V		チップセラコン	
C102	US062220	C. CE. CHP	220pF	50V		チップセラコン	
C103	US062220	C. CE. CHP	220pF	50V		チップセラコン	
C104	US062220	C. CE. CHP	220pF	50V		チップセラコン	
C105	US062220	C. CE. CHP	220pF	50V		チップセラコン	
C106	US062220	C. CE. CHP	220pF	50V		チップセラコン	
C107	UA652100	C. MYLAR	100pF	50V		マイラーコン	01
C108	UA652100	C. MYLAR	100pF	50V		マイラーコン	01
C109	UA652100	C. MYLAR	100pF	50V		マイラーコン	01
C110	UA652100	C. MYLAR	100pF	50V		マイラーコン	01
C111	FG651470	C. CE	47pF	50V		セラコン	01
C112	FG651470	C. CE	47pF	50V		セラコン	01
C113	UR837100	C. EL	10uF	16V		ケミコン	01
C114	UR837100	C. EL	10uF	16V		ケミコン	01
C115	UR837100	C. EL	10uF	16V		ケミコン	01
C116	UR837100	C. EL	10uF	16V		ケミコン	01
C117	UR837100	C. EL	10uF	16V		ケミコン	01
C118	UR837100	C. EL	10uF	16V		ケミコン	01
C119	UA653470	C. MYLAR	4700pF	50V		マイラーコン	01
C120	UA653470	C. MYLAR	4700pF	50V		マイラーコン	01
C121	UR837100	C. EL	10uF	16V		ケミコン	01
C122	VE326000	C. MYLAR. ML	0.1uF	50V		積層マイラーコン	01
C123	VE326000	C. MYLAR. ML	0.1uF	50V		積層マイラーコン	01
C124	UR837100	C. EL	10uF	16V		ケミコン	01
C125	US135100	C. CE. CHP	0.1uF	16V		チップセラコン	
C127	UR837100	C. EL	10uF	16V		ケミコン	01
C128	UR837100	C. EL	10uF	16V		ケミコン	01
C130	VE326000	C. MYLAR. ML	0.1uF	50V		積層マイラーコン	01
C131	VE326000	C. MYLAR. ML	0.1uF	50V		積層マイラーコン	01
C132	US135100	C. CE. CHP	0.1uF	16V		チップセラコン	
C133	US135100	C. CE. CHP	0.1uF	16V		チップセラコン	
C134	US135100	C. CE. CHP	0.1uF	16V		チップセラコン	
C135	UR838100	C. EL	100uF	16V		ケミコン	01
C136	UR838100	C. EL	100uF	16V		ケミコン	01
C137	UR847470	C. EL	47uF	25V		ケミコン	
C138	UR847470	C. EL	47uF	25V		ケミコン	
C139	UR837100	C. EL	10uF	16V		ケミコン	01
C140	UR837100	C. EL	10uF	16V		ケミコン	01
C141	UR837100	C. EL	10uF	16V		ケミコン	01
C142	UR837100	C. EL	10uF	16V		ケミコン	01
C143	UR866220	C. EL	2.2uF	50V		ケミコン	
C144	UR837100	C. EL	10uF	16V		ケミコン	01
C145	UR837100	C. EL	10uF	16V		ケミコン	01
C146	UR837100	C. EL	10uF	16V		ケミコン	01
C151	UR866330	C. EL	3.3uF	50V		ケミコン	
C152	UR877220	C. EL	22uF	63V		ケミコン	
C153	UR837100	C. EL	10uF	16V		ケミコン	01
C154	UR837100	C. EL	10uF	16V		ケミコン	01
C155	UA652100	C. MYLAR	100pF	50V		マイラーコン	01
C156	UR837100	C. EL	10uF	16V		ケミコン	01
C159	UA654270	C. MYLAR	0.027uF	50V		マイラーコン	01
C160	UA654270	C. MYLAR	0.027uF	50V		マイラーコン	01
C161	UR837100	C. EL	10uF	16V		ケミコン	01

* New Parts * 新規部品(マーク#の部品は、基板に含まれません)

P.C.B. FUNCTION

Schm Ref.	PART NO.	Description	Remarks	Markets	部 品 名	Rank	
C162	UR837100	C. EL	10uF	16V		ケミコン	01
C163	UA654270	C. MYLAR	0.027uF	50V		マイラーコン	01
C164	UA654270	C. MYLAR	0.027uF	50V		マイラーコン	01
C167	UA652100	C. MYLAR	100pF	50V		マイラーコン	01
C170	UR847470	C. EL	47uF	25V		ケミコン	
C171	UR847470	C. EL	47uF	25V		ケミコン	
C174	UA652100	C. MYLAR	100pF	50V		マイラーコン	01
C175	UA652100	C. MYLAR	100pF	50V		マイラーコン	01
C180	UR837100	C. EL	10uF	16V		ケミコン	01
C181	UR837100	C. EL	10uF	16V		ケミコン	01
C182	UA654100	C. MYLAR	0.01uF	50V		マイラーコン	01
C183	UA654100	C. MYLAR	0.01uF	50V		マイラーコン	01
C188	UR838100	C. EL	100uF	16V		ケミコン	01
C189	UR838100	C. EL	100uF	16V		ケミコン	01
C251	US064100	C. CE. M. CHP	0.01uF	50V		チップセラコン	
C252	UA654100	C. MYLAR	0.01uF	50V		マイラーコン	01
C253	US064100	C. CE. M. CHP	0.01uF	50V		チップセラコン	
C254	UA652100	C. MYLAR	100pF	50V		マイラーコン	01
C255	UA652100	C. MYLAR	100pF	50V		マイラーコン	01
C256	UA652100	C. MYLAR	100pF	50V		マイラーコン	01
C257	UA652100	C. MYLAR	100pF	50V		マイラーコン	01
C258	UA652100	C. MYLAR	100pF	50V		マイラーコン	01
C259	UA652100	C. MYLAR	100pF	50V		マイラーコン	01
C260	UA652100	C. MYLAR	100pF	50V		マイラーコン	01
C261	UA652100	C. MYLAR	100pF	50V		マイラーコン	01
C262	FG651470	C. CE	47pF	50V		セラコン	01
C263	FG651470	C. CE	47pF	50V		セラコン	01
C264	UR837100	C. EL	10uF	16V		ケミコン	01
C265	UR837100	C. EL	10uF	16V		ケミコン	01
C581	US135100	C. CE. CHP	0.1uF	16V		チップセラコン	
C582	US063100	C. CE. M. CHP	1000pF	50V		チップセラコン	
C583	US063100	C. CE. M. CHP	1000pF	50V		チップセラコン	
C584	UR837100	C. EL	10uF	16V		ケミコン	01
C585	US064100	C. CE. M. CHP	0.01uF	50V		チップセラコン	
C586	US135100	C. CE. CHP	0.1uF	16V		チップセラコン	
C587	US061330	C. CE. M. CHP	33pF	50V		チップセラコン	
C588	UR818330	C. EL	330uF	6.3V		ケミコン	01
C589	US135100	C. CE. CHP	0.1uF	16V		チップセラコン	
C594	US135100	C. CE. CHP	0.1uF	16V		チップセラコン	
C596	US135100	C. CE. CHP	0.1uF	16V		チップセラコン	
C597	US064100	C. CE. M. CHP	0.01uF	50V		チップセラコン	
C652	UR838100	C. EL	100uF	16V		ケミコン	01
C653	UR838100	C. EL	100uF	16V		ケミコン	01
C655	UR867100	C. EL	10uF	50V		ケミコン	
C656	UR867100	C. EL	10uF	50V		ケミコン	
C657	UR838100	C. EL	100uF	16V		ケミコン	01
C658	UR867100	C. EL	10uF	50V		ケミコン	
C659	UR73A100	C. EL	10000uF	16V		ケミコン	
* C660	UR759220	C. EL	2200uF	35V		ケミコン	
* C661	UR759100	C. EL	1000uF	35V		ケミコン	02
C663	VE326000	C. MYLAR. ML	0.1uF	50V		積層マイラーコン	01
C664	VE326000	C. MYLAR. ML	0.1uF	50V		積層マイラーコン	01
C665	VE326000	C. MYLAR. ML	0.1uF	50V		積層マイラーコン	01

* New Parts * 新規部品(マーク#の部品は、基板に含まれません)

P.C.B. FUNCTION

Schm Ref.	PART NO.	Description	Remarks	Markets	部 品 名	Rank
C666	VE326000	C. MYLAR. ML	0.1uF 50V		積層マイラーコン	01
C668	VE326000	C. MYLAR. ML	0.1uF 50V		積層マイラーコン	01
C670	UA654100	C. MYLAR	0.01uF 50V		マイラーコン	01
D101	VU994300	DIODE. ZENR	MA8075-H 7.7V		ツェナーダイオード	
D102	VU994300	DIODE. ZENR	MA8075-H 7.7V		ツェナーダイオード	
D581	VV658700	DIODE. ZENR	RLZ6.2B 6.2V		ツェナーダイオード	
△ D651	WA653100	DIODE. BRG	KBP103G 1.0A 200V		ダイオードブリッジ	
△ D652	WA653100	DIODE. BRG	KBP103G 1.0A 200V		ダイオードブリッジ	
G584	VR463400	TERM. GND	D3.5		アース端子	01
G651	VR463400	TERM. GND	D3.5		アース端子	01
IC101	X3547A00	IC	BD3841FS		IC	
IC102	X3546A00	IC	BD3815KS		IC	
IC104	XP896A00	IC	LC78213		IC	
IC105	XJ553A00	IC	NJM2068MD		IC	02
IC106	XJ553A00	IC	NJM2068MD		IC	02
IC581	XV160A00	IC	LC75712E FLD		ロジックICフラット	
* △ IC652	X4153A00	IC	K1A7812P1		電源IC	
* △ IC653	X4154A00	IC	K1A7912P1		電源IC	
△ IC654	XN169A00	IC	K1A7805P1 5V		電源IC	
PJ101	V7190400	JACK. PIN	6P		ピンジャック 6P	
PJ102	V7046800	JACK. PIN	MSP-246V1-01N1		ピンジャック 6P	
PJ251	V7046800	JACK. PIN	MSP-246V1-01N1		ピンジャック 6P	
PJ252	V7046700	JACK. PIN	MSP-244V1-01N1		ピンジャック 4P	
PJ253	V7189700	JACK. PIN	1P		ピンジャック 1P	
* PN101	WB213200	PIN	L=70 WB21320		スタイルピン	
* PN251	WB213200	PIN	L=70 WB21320		スタイルピン	
* PN252	WB213200	PIN	L=70 WB21320		スタイルピン	
* PN651	WB213200	PIN	L=70 WB21320		スタイルピン	
Q101	iC181510	TR	2SC1815 Y		トランジスタ	01
Q102	iA101510	TR	2SA1015 Y		トランジスタ	01
Q251	VD303700	TR	2SC3326 A,B		トランジスタ	01
Q252	VD303700	TR	2SC3326 A,B		トランジスタ	01
Q581	VV556400	TR	2SC2412K Q, R, S		トランジスタ	
Q582	VV556400	TR	2SC2412K Q, R, S		トランジスタ	
Q585	VV556400	TR	2SC2412K Q, R, S		トランジスタ	
Q586	VV556400	TR	2SC2412K Q, R, S		トランジスタ	
Q588	VV556400	TR	2SC2412K Q, R, S		トランジスタ	
Q591	VV556400	TR	2SC2412K Q, R, S		トランジスタ	
R200	HV753220	R. CAR. FP	2.2Ω 1/4W		不燃化カーボン抵抗	01
R201	HV753220	R. CAR. FP	2.2Ω 1/4W		不燃化カーボン抵抗	01
R622	HV755100	R. CAR. FP	100Ω 1/4W		不燃化カーボン抵抗	01
R624	HV755100	R. CAR. FP	100Ω 1/4W		不燃化カーボン抵抗	01
R651	HV753100	R. CAR. FP	1Ω 1/4W		不燃化カーボン抵抗	
R652	HV753100	R. CAR. FP	1Ω 1/4W		不燃化カーボン抵抗	
R654	HV754330	R. CAR. FP	33Ω 1/4W		不燃化カーボン抵抗	01
R655	HV754330	R. CAR. FP	33Ω 1/4W		不燃化カーボン抵抗	01
R656	VP939500	R. MTL. FLM	1Ω 1W		金属被膜抵抗	
ST102	V4040500	SCR. TERM	M3		スクリューターミナル	
SW581	V9281300	SW. RT. ENC	EVEKD2F3024B		ロータリーエンコーダ	
SW582	VV020300	SW. TACT	SKQNAA		タクトSW	01
SW583	VV020300	SW. TACT	SKQNAA		タクトSW	01
SW584	VV020300	SW. TACT	SKQNAA		タクトSW	01
SW585	VV020300	SW. TACT	SKQNAA		タクトSW	01

* New Parts * 新規部品(マーク#の部品は、基板に含まれません)

P.C.B. FUNCTION & P.C.B. MAIN

Schm Ref.	PART NO.	Description	Remarks	Markets	部 品 名	Rank
SW586	VV020300	SW. TACT	SKQNAA		タクトSW	01
SW587	VV020300	SW. TACT	SKQNAA		タクトSW	01
SW588	VV020300	SW. TACT	SKQNAA		タクトSW	01
SW589	VV020300	SW. TACT	SKQNAA		タクトSW	01
SW590	VV020300	SW. TACT	SKQNAA		タクトSW	01
SW591	VV020300	SW. TACT	SKQNAA		タクトSW	01
SW592	VV020300	SW. TACT	SKQNAA		タクトSW	01
SW593	VV020300	SW. TACT	SKQNAA		タクトSW	01
SW594	VV020300	SW. TACT	SKQNAA		タクトSW	01
SW595	VV020300	SW. TACT	SKQNAA	BG	タクトSW	01
SW597	VV020300	SW. TACT	SKQNAA	BG	タクトSW	01
SW598	VV020300	SW. TACT	SKQNAA		タクトSW	01
SW599	VV020300	SW. TACT	SKQNAA	BG	タクトSW	01
SW600	VV020300	SW. TACT	SKQNAA		タクトSW	01
SW601	VV020300	SW. TACT	SKQNAA	BG	タクトSW	01
SW602	VV020300	SW. TACT	SKQNAA		タクトSW	01
SW603	VV020300	SW. TACT	SKQNAA		タクトSW	01
SW770	VZ075500	SW. SLIDE	SL14-22AM5F	R	スライドSW	
U581	V8444900	L. DTCT	GP1UM271XK		リモコン受光ユニット	
V581	WA531200	FL. DSPLY	HNA-16MM43		蛍光表示管	
	V6880300	SHEET			シート/FL	
	V6071000	SPACER	4.6/10/32		スペーサ FL	
	WB138200	P. C. B.	MAIN	J	PCB メイン	
	WB138300	P. C. B.	MAIN	UC	PCB メイン	
	WB138400	P. C. B.	MAIN	R	PCB メイン	
	WB138500	P. C. B.	MAIN	T	PCB メイン	
	WB138600	P. C. B.	MAIN	KL	PCB メイン	
	WB138700	P. C. B.	MAIN	A	PCB メイン	
	WB138800	P. C. B.	MAIN	BG	PCB メイン	
CB281	VK026400	CN. BS. PIN	5P		ワイヤートラップ	
CB301	VQ963000	CN. BS. PIN	9P		ウエハー	
CB302	VQ585100	CN. BS. PIN	9P		ケーブルホルダー	
CB303	VK024700	CN. BS. PIN	3P		ワイヤートラップ	01
CB304	LB932040	CN. BS. PIN	4P		ベースポスト	01
CB471	VM859600	CN. BS. PIN	15P		FFCコネクタ	01
CB472	VN394900	CN. BS. PIN	14P		FFCコネクタ	
CB473	VQ963100	CN. BS. PIN	10P		ウエハー	
CB474	VK025200	CN. BS. PIN	8P		ワイヤートラップ	
CB475	VQ963800	CN. BS. PIN	17P		ウエハー	
CB476	VQ044400	CN. BS. PIN	9P		FFCコネクタ	
CB477	Vi878300	CN. BS. PIN	5P		ケーブルホルダー	
CB681	Vi878100	CN. BS. PIN	3P		ケーブルホルダー	01
CB682	VP206500	HOLDER. FUS	EYF-52BCT		ヒューズホルダー	01
CB683	VP206500	HOLDER. FUS	EYF-52BCT		ヒューズホルダー	01
CB684	VG879900	CN. BS. PIN	2P		ベースピン	01
CB685	VG879900	CN. BS. PIN	2P		ベースピン	01
CB731	VQ585100	CN. BS. PIN	9P		ケーブルホルダー	
CB732	VQ585400	CN. BS. PIN	12P TE		ケーブルホルダー	
CB771	VQ585400	CN. BS. PIN	12P TE		ケーブルホルダー	
C281	US062100	C. CE. M. CHP	100pF 50V		チップセラコン	

* New Parts * 新規部品(マーク#の部品は、基板に含まれません)

P.C.B. MAIN

Schm Ref.	PART NO.	Description	Remarks	Markets	部 品 名	Rank
C282	US062100	C. CE. M. CHP	100pF 50V		チップセラコン	
C283	UR877100	C. EL	10uF 63V		ケミコン	
C284	UR877100	C. EL	10uF 63V		ケミコン	
C285	UR877100	C. EL	10uF 63V		ケミコン	
C286	UR877100	C. EL	10uF 63V		ケミコン	
C287	UR829100	C. EL	1000uF 10V		ケミコン	
C288	UR829100	C. EL	1000uF 10V		ケミコン	
C289	US063100	C. CE. M. CHP	1000pF 50V		チップセラコン	
C290	US063100	C. CE. M. CHP	1000pF 50V		チップセラコン	
C291	UR838100	C. EL	100uF 16V		ケミコン	01
C301	UA654100	C. MYLAR	0.01uF 50V		マイラーコン	01
C302	UR877100	C. EL	10uF 63V		ケミコン	
C303	UR877100	C. EL	10uF 63V		ケミコン	
C304	UR877100	C. EL	10uF 63V		ケミコン	
C305	UR867100	C. EL	10uF 50V		ケミコン	
C306	UR867100	C. EL	10uF 50V		ケミコン	
C307	UA652220	C. MYLAR	220pF 50V		マイラーコン	01
C308	UA652220	C. MYLAR	220pF 50V		マイラーコン	01
C309	UA652220	C. MYLAR	220pF 50V		マイラーコン	01
C310	UA652220	C. MYLAR	220pF 50V		マイラーコン	01
C311	UA652220	C. MYLAR	220pF 50V		マイラーコン	01
C312	UA652220	C. MYLAR	220pF 50V		マイラーコン	01
C313	UA652220	C. MYLAR	220pF 50V		マイラーコン	01
C314	UA652220	C. MYLAR	220pF 50V		マイラーコン	01
C315	UR867330	C. EL	33uF 50V		ケミコン	
C316	UR867330	C. EL	33uF 50V		ケミコン	
C317	UR867330	C. EL	33uF 50V		ケミコン	
C318	UR877220	C. EL	22uF 63V		ケミコン	
C319	UR877220	C. EL	22uF 63V		ケミコン	
C320	UR877100	C. EL	10uF 63V		ケミコン	
C321	UA652100	C. MYLAR	100pF 50V		マイラーコン	01
C322	UR877100	C. EL	10uF 63V		ケミコン	
C323	UR877100	C. EL	10uF 63V		ケミコン	
C324	FG650300	C. CE	3pF 50V		セラコン	01
C325	UR877100	C. EL	10uF 63V		ケミコン	
C326	UR877100	C. EL	10uF 63V		ケミコン	
C327	UR877100	C. EL	10uF 63V		ケミコン	
C328	UR877100	C. EL	10uF 63V		ケミコン	
C329	UR867330	C. EL	33uF 50V		ケミコン	
C330	UR867330	C. EL	33uF 50V		ケミコン	
C331	UA652220	C. MYLAR	220pF 50V		マイラーコン	01
C332	UR877220	C. EL	22uF 63V		ケミコン	
C333	UA652220	C. MYLAR	220pF 50V		マイラーコン	01
C334	UR876470	C. EL	4.7uF 63V		ケミコン	
C335	FG650300	C. CE	3pF 50V		セラコン	01
C336	FG650300	C. CE	3pF 50V		セラコン	01
C337	FG650300	C. CE	3pF 50V		セラコン	01
C338	FG650300	C. CE	3pF 50V		セラコン	01
C339	VE326000	C. MYLAR. ML	0.1uF 50V		積層マイラーコン	01
C340	VE326000	C. MYLAR. ML	0.1uF 50V		積層マイラーコン	01
C341	VE326000	C. MYLAR. ML	0.1uF 50V		積層マイラーコン	01
C342	VE326000	C. MYLAR. ML	0.1uF 50V		積層マイラーコン	01
C343	VE326000	C. MYLAR. ML	0.1uF 50V		積層マイラーコン	01

* New Parts * 新規部品(マーク#の部品は、基板に含まれません)

P.C.B. MAIN

Schm Ref.	PART NO.	Description	Remarks	Markets	部 品 名	Rank
C344	UR866470	C. EL	4. 7uF 50V		ケミコン	01
C345	UR828100	C. EL	100uF 10V		ケミコン	01
C346	UR866470	C. EL	4. 7uF 50V		ケミコン	01
C347	UR868100	C. EL	100uF 50V		ケミコン	01
* C349	WB121500	C. EL	6800uF 56V	UCRTKAL	ケミコン	
* C349	WB228900	C. EL	6800uF 56V	JBG	ケミコン	
* C350	WB121500	C. EL	6800uF 56V	UCRTKAL	ケミコン	
* C350	WB228900	C. EL	6800uF 56V	JBG	ケミコン	
C351	UA654100	C. MYLAR	0. 01uF 50V	RTKABGL	マイラーコン	01
C352	UA654100	C. MYLAR	0. 01uF 50V	RTKABGL	マイラーコン	01
C354	UA654100	C. MYLAR	0. 01uF 50V	ABG	マイラーコン	01
C355	UA654100	C. MYLAR	0. 01uF 50V	ABG	マイラーコン	01
C356	UA654100	C. MYLAR	0. 01uF 50V		マイラーコン	01
C357	VT898000	C. MYLAR	0. 1uF 100V		マイラーコン	01
C358	VT898000	C. MYLAR	0. 1uF 100V		マイラーコン	01
C359	UR858100	C. EL	100uF 35V		ケミコン	
C471	US064100	C. CE. M. CHP	0. 01uF 50V		チップセラコン	
C472	US062100	C. CE. M. CHP	100pF 50V		チップセラコン	
C473	US063100	C. CE. M. CHP	1000pF 50V		チップセラコン	
C474	US062100	C. CE. M. CHP	100pF 50V		チップセラコン	
C475	US135100	C. CE. CHP	0. 1uF 16V		チップセラコン	
C476	US062100	C. CE. M. CHP	100pF 50V		チップセラコン	
C477	US062100	C. CE. M. CHP	100pF 50V		チップセラコン	
C478	UR857470	C. EL	47uF 35V		ケミコン	
C480	UR877100	C. EL	10uF 63V		ケミコン	
C482	UR877100	C. EL	10uF 63V	R	ケミコン	
C483	UR847470	C. EL	47uF 25V		ケミコン	
C484	UR866100	C. EL	1uF 50V		ケミコン	01
C485	WB165500	C. EL	0. 33F 5. 5V		ゴールドキャパシタ	
C486	UR818220	C. EL	220uF 6. 3V		ケミコン	
C487	UR847470	C. EL	47uF 25V		ケミコン	
C488	UR819100	C. EL	1000uF 6. 3V		ケミコン	01
C489	UR877100	C. EL	10uF 63V		ケミコン	
C490	UR819100	C. EL	1000uF 6. 3V		ケミコン	01
C491	US135100	C. CE. CHP	0. 1uF 16V	BG	チップセラコン	
C492	US135100	C. CE. CHP	0. 1uF 16V		チップセラコン	
C493	US135100	C. CE. CHP	0. 1uF 16V		チップセラコン	
C494	US062330	C. CE. M. CHP	330pF 50V	BG	チップセラコン	
C495	US062330	C. CE. M. CHP	330pF 50V	BG	チップセラコン	
C496	UR847470	C. EL	47uF 25V	BG	ケミコン	
C497	UR847470	C. EL	47uF 25V	BG	ケミコン	
C498	US062560	C. CE. CHP	560pF 50V	BG	チップセラ (S L)	
C499	VA761100	C. CE	27pF 50V	BG	セラコン	01
C500	US135100	C. CE. CHP	0. 1uF 16V	BG	チップセラコン	
C501	VA761100	C. CE	27pF 50V	BG	セラコン	01
C502	UR847470	C. EL	47uF 25V	BG	ケミコン	
C503	US135100	C. CE. CHP	0. 1uF 16V		チップセラコン	
C504	US135100	C. CE. CHP	0. 1uF 16V		チップセラコン	
C505	UR866220	C. EL	2. 2uF 50V		ケミコン	
C506	UR866220	C. EL	2. 2uF 50V		ケミコン	
C507	UR866220	C. EL	2. 2uF 50V		ケミコン	
C508	US062100	C. CE. M. CHP	100pF 50V		チップセラコン	
C509	US135100	C. CE. CHP	0. 1uF 16V		チップセラコン	

* New Parts * 新規部品(マーク#の部品は、基板に含まれません)

P.C.B. MAIN

Schm Ref.	PART NO.	Description	Remarks	Markets	部 品 名	Rank
C510	US135100	C. CE. CHP	0. 1uF 16V		チップセラコン	
C511	UR837330	C. EL	33uF 16V		ケミコン	01
C512	US135100	C. CE. CHP	0. 1uF 16V		チップセラコン	
C513	US135220	C. CE. CHP	0. 22uF 16V		チップセラ (F)	
C514	US135220	C. CE. CHP	0. 22uF 16V		チップセラ (F)	
* C681	UR658470	C. EL	470uF 35V		ケミコン	
C682	UR867100	C. EL	10uF 50V	R	ケミコン	
C683	UA654100	C. MYLAR	0. 01uF 50V	JUCTKABGL	マイラーコン	01
C684	UA654100	C. MYLAR	0. 01uF 50V	R	マイラーコン	01
C685	UA654100	C. MYLAR	0. 01uF 50V	R	マイラーコン	01
* ⚠ C686	WB121400	C. CE. SAFTY	0. 01uF 295V		規格認定コン	
C687	UA654100	C. MYLAR	0. 01uF 50V		マイラーコン	01
C731	UA654100	C. MYLAR	0. 01uF 50V	T	マイラーコン	01
C731	UA654100	C. MYLAR	0. 01uF 50V	RTKABGL	マイラーコン	01
C732	UA654100	C. MYLAR	0. 01uF 50V	RTKABGL	マイラーコン	01
C733	UA654100	C. MYLAR	0. 01uF 50V	ABG	マイラーコン	01
C734	UA654100	C. MYLAR	0. 01uF 50V	ABG	マイラーコン	01
C735	UA654100	C. MYLAR	0. 01uF 50V	ABG	マイラーコン	01
C736	UA654100	C. MYLAR	0. 01uF 50V	ABG	マイラーコン	01
C772	UA654100	C. MYLAR	0. 01uF 50V	ABG	マイラーコン	01
C773	UA654100	C. MYLAR	0. 01uF 50V	ABG	マイラーコン	01
C773	UA654100	C. MYLAR	0. 01uF 50V		マイラーコン	01
C774	UA654100	C. MYLAR	0. 01uF 50V		マイラーコン	01
C775	UA654100	C. MYLAR	0. 01uF 50V		マイラーコン	01
⚠ D302	VD631600	D10DE	1SS133, 176		ダイオード	01
D303	VD631600	D10DE	1SS133, 176		ダイオード	01
D304	VD631600	D10DE	1SS133, 176		ダイオード	01
D305	VG441700	D10DE. ZENR	MTZJ20B 20V	RTKABGL	ツェナーダイオード	
D305	VG442000	D10DE. ZENR	MTZJ22A 22V	JUC	ツェナーダイオード	03
D307	VD631600	D10DE	1SS133, 176		ダイオード	01
D308	VD631600	D10DE	1SS133, 176		ダイオード	01
D309	VN008700	D10DE	1SS270A		ダイオード	01
D310	VN008700	D10DE	1SS270A		ダイオード	01
D311	VN008700	D10DE	1SS270A		ダイオード	01
D312	VN008700	D10DE	1SS270A		ダイオード	01
D313	VN008700	D10DE	1SS270A		ダイオード	01
D314	VD631600	D10DE	1SS133, 176		ダイオード	01
D315	VD631600	D10DE	1SS133, 176		ダイオード	01
D316	VD631600	D10DE	1SS133, 176		ダイオード	01
⚠ D317	VG443200	D10DE. ZENR	MTZJ30A 30V		ツェナーダイオード	
D321	VN008700	D10DE	1SS270A		ダイオード	01
D322	VN008700	D10DE	1SS270A		ダイオード	01
D323	VN008700	D10DE	1SS270A		ダイオード	01
D324	VN008700	D10DE	1SS270A		ダイオード	01
D326	VN008700	D10DE	1SS270A		ダイオード	01
⚠ D327	WA653200	D10DE. BRG	TS6P03G 6. 0A 200V		ダイオードブリッジ	
D471	VT332900	D10DE	1SS355		ダイオード	
D472	VT332900	D10DE	1SS355		ダイオード	
D473	VU172200	D10DE. ZENR	UDZ6. 8B 6. 8V		ツェナーダイオード	
D474	VU172100	D10DE. ZENR	UDZS6. 2B 6. 2V		ツェナーダイオード	
D475	VT332900	D10DE	1SS355		ダイオード	
D476	VT332900	D10DE	1SS355		ダイオード	
D477	VU172000	D10DE. ZENR	UDZS5. 6BTE-17 5. 6V		ツェナーダイオード	01

* New Parts * 新規部品(マーク#の部品は、基板に含まれません)

P.C.B. MAIN

Schm Ref.	PART NO.	Description	Remarks	Markets	部 品 名	Rank
D478	VT332900	D10DE	1SS355		ダイオード	
D479	VT332900	D10DE	1SS355		ダイオード	
D480	VU171900	D10DE. ZENR	UDZ5.1B 5.1V		ツェナーダイオード	01
D481	VU171900	D10DE. ZENR	UDZ5.1B 5.1V		ツェナーダイオード	01
D482	VU171900	D10DE. ZENR	UDZ5.1B 5.1V		ツェナーダイオード	01
D483	VT332900	D10DE	1SS355	R	ダイオード	
D484	VU171900	D10DE. ZENR	UDZ5.1B 5.1V		ツェナーダイオード	01
D485	VU171900	D10DE. ZENR	UDZ5.1B 5.1V		ツェナーダイオード	01
D486	VU171900	D10DE. ZENR	UDZ5.1B 5.1V		ツェナーダイオード	01
D487	VU171900	D10DE. ZENR	UDZ5.1B 5.1V		ツェナーダイオード	01
D681	VD631600	D10DE	1SS133, 176		ダイオード	01
D682	VG437000	D10DE. ZENR	MTZJ4.7A 4.7V	R	ツェナーダイオード	01
⚠ D683	VS997800	D10DE	1T2		ダイオード	
⚠ D684	VS997800	D10DE	1T2		ダイオード	
⚠ D685	VS997800	D10DE	1T2	R	ダイオード	
⚠ D686	VS997800	D10DE	1T2		ダイオード	
⚠ D687	VS997800	D10DE	1T2		ダイオード	
D771	VU172500	D10DE. ZENR	UDZS9.1B		ツェナーダイオード	
D772	VT332900	D10DE	1SS355		ダイオード	
D773	VT332900	D10DE	1SS355		ダイオード	
* ⚠ F681	VV071600	FUSE	2.5A 250V	TKABGL	ヒューズ 2 5 0 V	
* ⚠ F681	WB221100	FUSE	5.0A 125V	JUCR	ヒューズ 1 2 5 V	
G302	VR463400	TERM. GND	D3.5		アース端子	01
G303	VR463400	TERM. GND	D3.5		アース端子	01
G304	VR463400	TERM. GND	D3.5		アース端子	01
G471	VR463400	TERM. GND	D3.5		アース端子	01
IC281	XH436A00	IC	LA7956		IC	03
* ⚠ IC301	X3830A00	IC	STK404-120 120W		アンプ IC SIP	
* ⚠ IC302	X3829A00	IC	STK402-120Y 120W		アンプ IC SIL	
* ⚠ IC303	X3829A00	IC	STK402-120Y 120W		アンプ IC SIL	
IC471	XY534A00	IC	LC72722		RDSデコーダ IC	
* IC472	X4660A00	IC, CPU	M3062VMGP-070FP	MASK ROM	IC、CPU	
JK771	V9408200	JACK. PHONE	MSJ-064-05B GR		ホーンジャック	
* L301	WB121000	COIL	LSSYM02C-001		空芯コイル	
* L302	WB121000	COIL	LSSYM02C-001		空芯コイル	
* L303	WB121000	COIL	LSSYM02C-001		空芯コイル	
* L304	WB121000	COIL	LSSYM02C-001		空芯コイル	
* L305	WB121000	COIL	LSSYM02C-001		空芯コイル	
L471	VU889500	COIL	220uH	BG	円筒形固定コイル	
PJ281	V7190000	JACK. PIN	2P		ピンジャック 2 P	
PJ282	V7190000	JACK. PIN	2P		ピンジャック 2 P	
PJ283	V7190000	JACK. PIN	2P		ピンジャック 2 P	
* PN731	WB213200	PIN	L=70 WB21320		スタイルピン	
* PN732	WB213200	PIN	L=70 WB21320		スタイルピン	
Q281	iC181510	TR	2SC1815 Y		トランジスタ	01
Q282	iC181510	TR	2SC1815 Y		トランジスタ	01
Q283	iC174020	TR	2SC1740S R, S		トランジスタ	01
⚠ Q301	VD303700	TR	2SC3326 A, B		トランジスタ	01
⚠ Q302	VD303700	TR	2SC3326 A, B		トランジスタ	01
⚠ Q303	VD303700	TR	2SC3326 A, B		トランジスタ	01
⚠ Q304	VD303700	TR	2SC3326 A, B		トランジスタ	01
⚠ Q305	VD303700	TR	2SC3326 A, B		トランジスタ	01
⚠ Q306	VP883100	TR	2SC1890A D, E		トランジスタ	01

* New Parts * 新規部品(マーク#の部品は、基板に含まれません)

P.C.B. MAIN

Schm Ref.	PART NO.	Description	Remarks	Markets	部 品 名	Rank	
△ Q307	VC407900	TR	2SD1913 R, S			トランジスタ	01
Q308	V3966800	TR	2SB949 O, Y			トランジスタ	
△ Q309	VC614000	TR	2SB1274 O, R, S			トランジスタ	02
Q310	VP883000	TR	2SA893A D, E			トランジスタ	
△ Q311	VP883000	TR	2SA893A D, E			トランジスタ	
Q312	VP883100	TR	2SC1890A D, E			トランジスタ	01
Q313	VP883100	TR	2SC1890A D, E			トランジスタ	01
Q314	VP883100	TR	2SC1890A D, E			トランジスタ	01
Q315	VP883100	TR	2SC1890A D, E			トランジスタ	01
Q316	VP883100	TR	2SC1890A D, E			トランジスタ	01
Q317	VP883000	TR	2SA893A D, E			トランジスタ	
Q318	iA101510	TR	2SA1015 Y			トランジスタ	01
Q319	VV655300	TR. DGT	DTA144EKA			デジタルトランジスタ	01
Q320	VV655300	TR. DGT	DTA144EKA			デジタルトランジスタ	01
Q321	VV655300	TR. DGT	DTA144EKA			デジタルトランジスタ	01
Q322	iC181510	TR	2SC1815 Y			トランジスタ	01
Q471	VP872700	TR	2SC4488 S, T			トランジスタ	
Q472	VV556500	TR	2SA1037K O, R, S			トランジスタ	
Q473	VP872700	TR	2SC4488 S, T		R	トランジスタ	
Q474	iC181510	TR	2SC1815 Y			トランジスタ	01
Q475	VV556400	TR	2SC2412K O, R, S			トランジスタ	
Q476	iC174020	TR	2SC1740S R, S		BG	トランジスタ	01
Q477	VV556500	TR	2SA1037K O, R, S			トランジスタ	
Q478	VV556500	TR	2SA1037K O, R, S			トランジスタ	
Q479	VV556500	TR	2SA1037K O, R, S			トランジスタ	
Q480	VV655700	TR. DGT	DTC144EKA			デジタルトランジスタ	01
Q481	VV655700	TR. DGT	DTC144EKA			デジタルトランジスタ	01
Q681	VE198800	TR	2SC2705 O, Y			トランジスタ	01
Q682	iA101510	TR	2SA1015 Y		R	トランジスタ	01
Q683	VP872600	TR	2SA1708 S, T		R	トランジスタ	
Q684	iA101510	TR	2SA1015 Y		R	トランジスタ	01
Q685	VD678700	TR. DGT	DTC114ES		R	デジタルトランジスタ	03
R289	HV755270	R. CAR. FP	270Ω 1/4W			不燃化カーボン抵抗	01
R294	HV753220	R. CAR. FP	2.2Ω 1/4W			不燃化カーボン抵抗	01
R330	HV753220	R. CAR. FP	2.2Ω 1/4W			不燃化カーボン抵抗	01
R331	HV753220	R. CAR. FP	2.2Ω 1/4W			不燃化カーボン抵抗	01
R333	HV753220	R. CAR. FP	2.2Ω 1/4W			不燃化カーボン抵抗	01
R335	HV753220	R. CAR. FP	2.2Ω 1/4W			不燃化カーボン抵抗	01
R336	HV753220	R. CAR. FP	2.2Ω 1/4W			不燃化カーボン抵抗	01
R337	HV753220	R. CAR. FP	2.2Ω 1/4W			不燃化カーボン抵抗	01
△ R338	HV754100	R. CAR. FP	10Ω 1/4W			不燃化カーボン抵抗	01
△ R345	HV756470	R. CAR. FP	4.7KΩ 1/4W			不燃化カーボン抵抗	01
△ R346	HV754100	R. CAR. FP	10Ω 1/4W			不燃化カーボン抵抗	01
R350	WB279900	R. WW	RGC55C 0.22+0.22			セメント抵抗	
R358	WB279900	R. WW	RGC55C 0.22+0.22			セメント抵抗	
R359	WB279900	R. WW	RGC55C 0.22+0.22			セメント抵抗	
R360	WB279900	R. WW	RGC55C 0.22+0.22			セメント抵抗	
R361	WB279900	R. WW	RGC55C 0.22+0.22			セメント抵抗	
R368	HV753470	R. CAR. FP	4.7Ω 1/4W			不燃化カーボン抵抗	01
△ R373	VP939700	R. MTL. FLM	4.7Ω 1W			金属被膜抵抗	01
R379	HV753470	R. CAR. FP	4.7Ω 1/4W			不燃化カーボン抵抗	01
R381	HV753470	R. CAR. FP	4.7Ω 1/4W			不燃化カーボン抵抗	01
R383	HV753470	R. CAR. FP	4.7Ω 1/4W			不燃化カーボン抵抗	01

* New Parts * 新規部品(マーク#の部品は、基板に含まれません)

P.C.B. MAIN

Schm Ref.	PART NO.	Description	Remarks	Markets	部 品 名	Rank	
	R385	HV753470	R. CAR. FP	4.7Ω 1/4W		不燃化カーボン抵抗	01
△	R390	VP939700	R. MTL. FLM	4.7Ω 1W		金属被膜抵抗	01
△	R391	VP939700	R. MTL. FLM	4.7Ω 1W		金属被膜抵抗	01
△	R392	VP939700	R. MTL. FLM	4.7Ω 1W		金属被膜抵抗	01
△	R393	VP939700	R. MTL. FLM	4.7Ω 1W		金属被膜抵抗	01
	R397	HV756330	R. CAR. FP	3.3KΩ 1/4W		不燃化カーボン抵抗	01
	R401	HV755330	R. CAR. FP	330Ω 1/4W		不燃化カーボン抵抗	01
	R418	HV753220	R. CAR. FP	2.2Ω 1/4W	RTKABGL	不燃化カーボン抵抗	01
	R419	HV753220	R. CAR. FP	2.2Ω 1/4W	RTKABGL	不燃化カーボン抵抗	01
	R421	HV753220	R. CAR. FP	2.2Ω 1/4W		不燃化カーボン抵抗	01
△	R424	HV754470	R. CAR. FP	47Ω 1/4W		不燃化カーボン抵抗	01
	R472	HV753220	R. CAR. FP	2.2Ω 1/4W		不燃化カーボン抵抗	01
*	R683	RD354150	R. CAR. CHP	15Ω 1/16W	R	チップ抵抗	
	R688	V6730000	R. CAR.	2.2MΩ 1/2W	UC	放電抵抗	
	R689	VC757900	R. MTL. OXD	47Ω 2W	R	酸化金属被膜抵抗	01
	R731	HV753220	R. CAR. FP	2.2Ω 1/4W	RTKABGL	不燃化カーボン抵抗	01
	R732	HV753220	R. CAR. FP	2.2Ω 1/4W	RTKABGL	不燃化カーボン抵抗	01
	R771	VP940800	R. MTL. OXD	470Ω 1W		酸化金属被膜抵抗	01
	R772	VP940800	R. MTL. OXD	470Ω 1W		酸化金属被膜抵抗	01
	RY301	V5966300	RELAY	DS24D2-0S(M)		リレー 24V	
	RY302	V5966300	RELAY	DS24D2-0S(M)		リレー 24V	
*	RY303	V5178900	RELAY	DC DQ24D1-0S(M)		リレー 24V	
△	RY681	V2712300	RELAY	DC SDT-S-112LMR		リレー 12V	
	ST681	V4040500	TERM	M3		スクリューターミナル	
	ST771	V4040500	TERM	M3		スクリューターミナル	
	SW281	V3624300	SW. SLIDE	SS029-P022MJB-PA6	R	スライドSW	
	SW771	VV523900	SW. PUSH	PBS-YM-001		プッシュSW	
△	T681	XW605A00	TRANS. PWR		J	電源トランス	
△	T681	XW606A00	TRANS. PWR		UC	電源トランス	
△	T681	XW608A00	TRANS. PWR		TKABGL	電源トランス	
△	T681	XW974A00	TRANS. PWR		R	電源トランス	
*	TE301	WB054000	TERM. SP	YKD21-5002N		スピーカターミナル	
	TE731	VY696300	TERM. SP	4P	JUCRTA	スピーカターミナル	
	TE731	VY696400	TERM. SP	4P	KBGL	スピーカターミナル	06
*	TE732	WB054100	TERM. SP	YKD21-5004N		スピーカターミナル	
	XL471	V3930900	RSNR. CRYST	4.332MHz	BG	水晶振動子	
*	XL472	WB213000	RSNR. CE	16.0MHz		セラミック振動子	
		EP600140	SCR. BND. HD	3x10 MFZ2BL		バインドBタイトネジ	01

* New Parts * 新規部品(マーク#の部品は、基板に含まれません)

Chip Resistors

Schm Ref.	PART NO.	Description	Remarks	Markets	部 品 名	Rank	
	RD350000	R. CHP	0Ω	1/16W		チップ抵抗	01
	RD353220	R. CHP	2.2Ω	1/16W		チップ抵抗	01
	RD354470	R. CHP	47Ω	1/16W		チップ抵抗	01
	RD354750	R. CHP	75Ω	1/16W		チップ抵抗	01
	RD354820	R. CHP	82Ω	1/16W		チップ抵抗	01
	RD355100	R. CHP	100Ω	1/16W		チップ抵抗	01
	RD355220	R. CHP	220Ω	1/16W		チップ抵抗	01
	RD355270	R. CHP	270Ω	1/16W		チップ抵抗	01
	RD355470	R. CHP	470Ω	1/16W		チップ抵抗	01
	RD355560	R. CHP	560Ω	1/16W		チップ抵抗	01
	RD355680	R. CHP	680Ω	1/16W		チップ抵抗	01
	RD356100	R. CHP	1KΩ	1/16W		チップ抵抗	01
	RD356120	R. CHP	1.2KΩ	1/16W		チップ抵抗	01
	RD356150	R. CHP	1.5KΩ	1/16W		チップ抵抗	01
	RD356180	R. CHP	1.8KΩ	1/16W		チップ抵抗	01
	RD356200	R. CHP	2KΩ	1/16W		チップ抵抗	01
	RD356220	R. CHP	2.2KΩ	1/16W		チップ抵抗	01
	RD356240	R. CHP	2.4KΩ	1/16W		チップ抵抗	01
	RD356270	R. CHP	2.7KΩ	1/16W		チップ抵抗	01
	RD356330	R. CHP	3.3KΩ	1/16W		チップ抵抗	01
	RD356390	R. CHP	3.9KΩ	1/16W		チップ抵抗	01
	RD356470	R. CHP	4.7KΩ	1/16W		チップ抵抗	01
	RD356510	R. CHP	5.1KΩ	1/16W		チップ抵抗	01
	RD356560	R. CHP	5.6KΩ	1/16W		チップ抵抗	01
	RD356680	R. CHP	6.8KΩ	1/16W		チップ抵抗	01
	RD356820	R. CHP	8.2KΩ	1/16W		チップ抵抗	01
	RD357100	R. CHP	10KΩ	1/16W		チップ抵抗	01
	RD357150	R. CHP	15KΩ	1/16W		チップ抵抗	01
	RD357180	R. CHP	18KΩ	1/16W		チップ抵抗	01
	RD357220	R. CHP	22KΩ	1/16W		チップ抵抗	01
	RD357330	R. CHP	33KΩ	1/16W		チップ抵抗	01
	RD357390	R. CHP	39KΩ	1/16W		チップ抵抗	01
	RD357470	R. CHP	47KΩ	1/16W		チップ抵抗	01
	RD357680	R. CHP	68KΩ	1/16W		チップ抵抗	01
	RD358100	R. CHP	100KΩ	1/16W		チップ抵抗	01
	RD358220	R. CHP	220KΩ	1/16W		チップ抵抗	01
	RD359100	R. CHP	1MΩ	1/16W		チップ抵抗	01

* New Parts * 新規部品(マーク#の部品は、基板に含まれません)

Parts List for Carbon Resistors

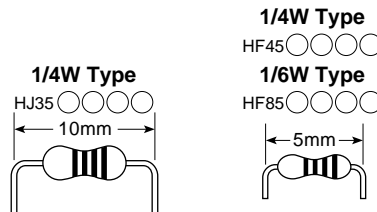
Value	1/4W Type Part No.	1/6W Type Part No.	Value	1/4W Type Part No.	1/6W Type Part No.
1.0 Ω	HJ35 3100	HF85 3100	10 kΩ	HF45 7100	HF45 7100
1.8 Ω	HJ35 3180	*	11 kΩ	HF45 7110	HF45 7110
2.2 Ω	HJ35 3220	HF85 3220	12 kΩ	HJ35 7120	HF85 7120
3.3 Ω	HJ35 3330	HF85 3330	13 kΩ	HF45 7130	HF45 7130
4.7 Ω	HJ35 3470	HF85 3470	15 kΩ	HF45 7150	HF45 7150
5.6 Ω	HJ35 3560	HF85 3560	18 kΩ	HF45 7180	HF45 7180
10 Ω	HF45 4100	HF45 4100	22 kΩ	HF45 7220	HF45 7220
15 Ω	HJ35 4150	HF85 4150	24 kΩ	HF45 7240	HF45 7240
22 Ω	HF45 4220	HF45 4220	27 kΩ	HJ35 7270	HF85 7270
27 Ω	HJ35 4270	HF85 4270	30 kΩ	HF45 7300	HF45 7300
33 Ω	HF45 4330	HF45 4330	33 kΩ	HF45 7330	HF45 7330
39 Ω	HJ35 4470	HF85 4390	36 kΩ	HF45 7360	HF45 7360
47 Ω	HF45 4470	HF45 4470	39 kΩ	HF45 7390	HF45 7390
56 Ω	HF45 4560	HF45 4560	47 kΩ	HF45 7470	HF45 7470
68 Ω	HF45 4680	HF45 4680	51 kΩ	HF45 7510	HF45 7510
75 Ω	HF45 4750	HF45 4750	56 kΩ	HF45 7560	HF45 7560
82 Ω	HF45 4820	HF45 4820	62 kΩ	HF45 7620	HF45 7620
91 Ω	HF45 4910	HF45 4910	68 kΩ	HF45 7680	HF45 7680
100 Ω	HF45 5100	HF45 5100	82 kΩ	HF45 7820	HF45 7820
110 Ω	HJ35 5110	HF85 5110	91 kΩ	HF45 7910	HF45 7910
120 Ω	HF45 5120	HF45 5120	100 kΩ	HF45 8100	HF45 8100
150 Ω	HF45 5150	HF45 5150	110 kΩ	HF45 8110	HF45 8110
160 Ω	HJ35 5160	*	120 kΩ	HF45 8120	HF45 8120
180 Ω	HF45 5180	HF45 5180	150 kΩ	HF45 8150	HF45 8150
200 Ω	HF45 5200	HF45 5200	180 kΩ	HF45 8180	HF45 8180
220 Ω	HF45 5220	HF45 5220	220 kΩ	HJ35 8220	HF85 8220
270 Ω	HF45 5270	HF45 5270	270 kΩ	HF45 8270	HF45 8270
330 Ω	HF45 5330	HF45 5330	300 kΩ	HF45 8300	HF45 8300
390 Ω	HF45 5390	HF45 5390	330 kΩ	HF45 8330	HF45 8330
430 Ω	HF45 5430	HF45 5430	390 kΩ	HJ35 8390	HF85 8390
470 Ω	HF45 5470	HF45 5470	470 kΩ	HF45 8470	HF45 8470
510 Ω	HF45 5510	HF45 5510	560 kΩ	HJ35 8560	HF85 8560
560 Ω	HF45 5560	HF45 5560	680 kΩ	HJ35 8680	HF85 8680
680 Ω	HF45 5680	HF45 5680	820 kΩ	HJ35 8820	HF85 8820
820 Ω	HF45 5820	HF45 5820	1.0 MΩ	HF45 9100	HF45 9100
910 Ω	HF45 5910	HF45 5910	1.2 MΩ	HJ35 9120	*
1.0 kΩ	HF45 6100	HF45 6100	1.5 MΩ	HJ35 9150	HF85 9150
1.2 kΩ	HF45 6120	HF45 6120	1.8 MΩ	HJ35 9180	HF85 9180
1.5 kΩ	HF45 6150	HF45 6150	2.2 MΩ	HJ35 9220	HF85 9220
1.8 kΩ	HF45 6180	HF45 6180	3.3 MΩ	HJ35 9330	HF85 9330
2.0 kΩ	HJ35 6200	HF85 6200	3.9 MΩ	HJ35 9390	*
2.2 kΩ	HF45 6220	HF45 6220	4.7 MΩ	HJ35 9470	HF85 9470
2.4 kΩ	HJ35 6240	HF85 6240			
2.7 kΩ	HF45 6270	HF45 6270			
3.0 kΩ	HF45 6300	HF45 6300			
3.3 kΩ	HF45 6330	HF45 6330			
3.6 kΩ	HJ35 6360	HF85 6360			
3.9 kΩ	HF45 6390	HF45 6390			
4.7 kΩ	HF45 6470	HF45 6470			
5.1 kΩ	HF45 6510	HF45 6510			
5.6 kΩ	HF45 6560	HF45 6560			
6.8 kΩ	HF45 6680	HF45 6680			
8.2 kΩ	HF45 6820	HF45 6820			
9.1 kΩ	HF45 6910	HF45 6910			
					

* : Not available

EXPLODED VIEW

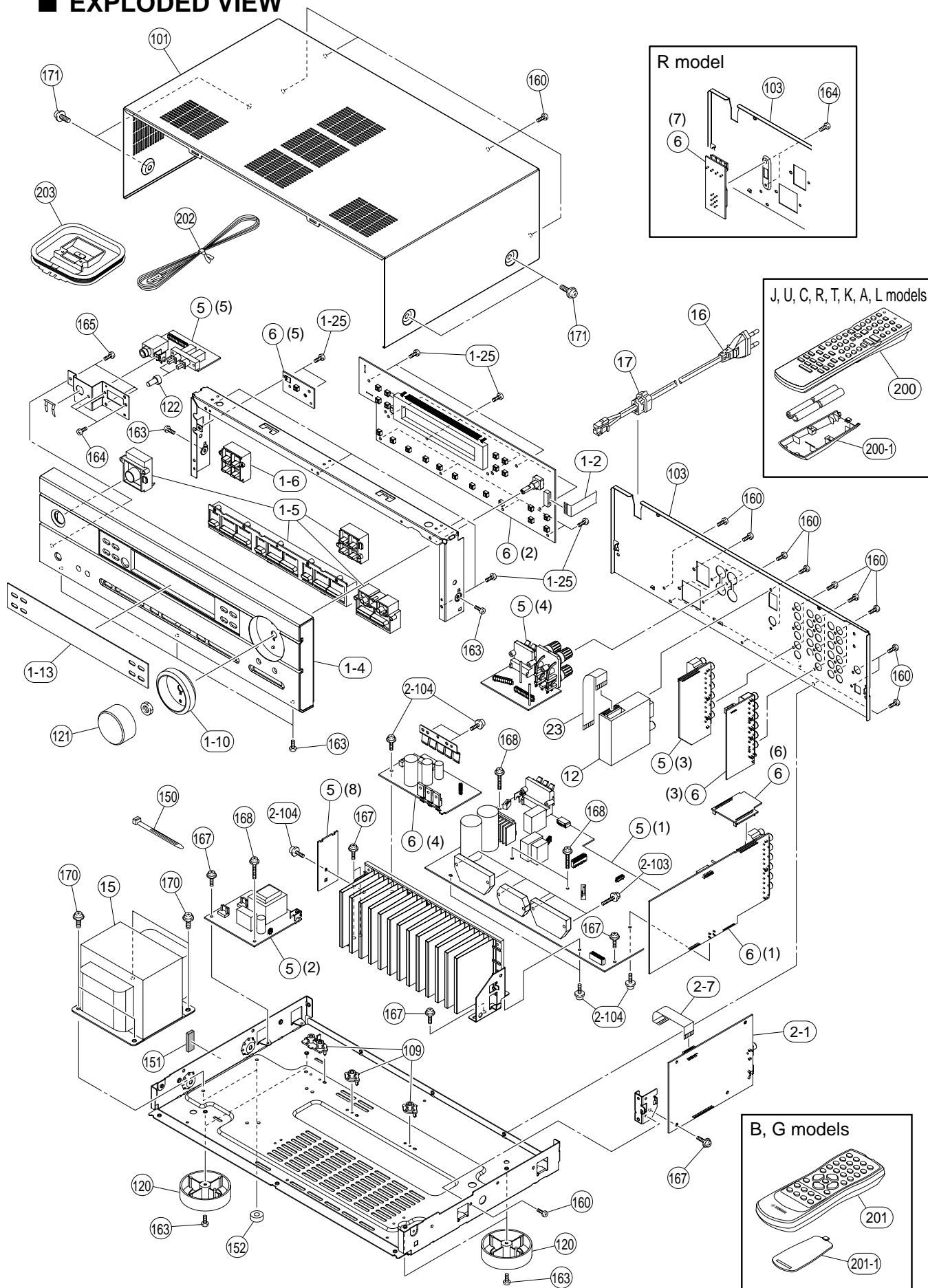

MECHANICAL PARTS

Schm Ref.	PART NO.	Description	Remarks	Markets	部 品 名	Rank
1-2	MF114160	FLEXIBLE FLAT CABLE	14P 160mm P=1.25		カード電線 C & C	
* 1-4	WA799000	FRONT PANEL		J	フロントパネル	
* 1-4	WA797700	FRONT PANEL		T	フロントパネル	
* 1-4	WA798000	FRONT PANEL		BG	フロントパネル	
* 1-4	WA799100	FRONT PANEL		J	フロントパネル	
* 1-4	WA797900	FRONT PANEL		CRL	フロントパネル	
* 1-4	WA798200	FRONT PANEL		BG	フロントパネル	
* 1-4	WA798400	FRONT PANEL		T	フロントパネル	
* 1-4	WA798300	FRONT PANEL		UCAR	フロントパネル	
* 1-4	WA798600	FRONT PANEL		BG	フロントパネル	
* 1-4	WA798500	FRONT PANEL		UCAR	フロントパネル	
* 1-4	WA798900	FRONT PANEL		BG	フロントパネル	
* 1-5	WA799400	BUTTONCASE 340			ボタンケース 3 4 0	
* 1-5	WA799300	BUTTONCASE 340			ボタンケース 3 4 0	
* 1-5	WA799700	BUTTONCASE 340			ボタンケース 3 4 0	
* 1-5	WA799800	BUTTONCASE 340			ボタンケース 3 4 0	
* 1-6	WA799900	BUTTON/RDS 340			ボタン/RDS 3 4 0	
* 1-6	WA802500	BUTTON/RDS 340		BG	ボタン/RDS 3 4 0	
* 1-10	WA794800	ESCUTCHEON/VOL			エスカッションVOL	
* 1-10	WA794700	ESCUTCHEON/VOL			エスカッションVOL	
* 1-10	WA795000	ESCUTCHEON/VOL			エスカッションVOL	
* 1-13	WA290500	SHEET, WINDOW		JCRL	シート/ウインドウ	
* 1-13	WA796300	SHEET, WINDOW		BG	シート/ウインドウ	
* 1-13	WA796400	SHEET, WINDOW		UCAR	シート/ウインドウ	
* 1-13	WA796500	SHEET, WINDOW		BG	シート/ウインドウ	
1-25	EP630220	BIND HEAD P-TITE SCREW	3x8 MFZN2BL		バインドPタイトネジ	
* 2-1	WB139200	P.C.B. ASS'Y	DSP	J	P C B D S P	
* 2-1	WB139300	P.C.B. ASS'Y	DSP	UCRKTABGL	P C B D S P	
* 2-7	MF113070	FLEXIBLE FLAT CABLE	13P 70mm P=1.25		カード電線 C & C	
* 2-103	VK865300	HEX. HEAD TAP. SCREW WITH WS	3x18 MFC2BL		座金付六角タッピングネジ	
* 2-104	VT669300	PW HEAD B-TITE SCREW	3x8-8 MFC2		PWヘッドBタイトネジ	
* 5	WB138200	P.C.B. ASS'Y	MAIN	J	P C B メイン	
* 5	WB138300	P.C.B. ASS'Y	MAIN	UC	P C B メイン	
* 5	WB138400	P.C.B. ASS'Y	MAIN	R	P C B メイン	
* 5	WB138500	P.C.B. ASS'Y	MAIN	T	P C B メイン	
* 5	WB138600	P.C.B. ASS'Y	MAIN	K	P C B メイン	
* 5	WB138700	P.C.B. ASS'Y	MAIN	A	P C B メイン	
* 5	WB138800	P.C.B. ASS'Y	MAIN	BG	P C B メイン	
* 6	WB138900	P.C.B. ASS'Y	FUNCTION	JUCTKAL	P C B ファンクション	
* 6	WB139000	P.C.B. ASS'Y	FUNCTION	R	P C B ファンクション	
* 6	WB139100	P.C.B. ASS'Y	FUNCTION	BG	P C B ファンクション	
12	V6782200	AM/FM TUNER	TFCE1J117A	J	AM/FM チューナ	
12	V6782300	AM/FM TUNER	TFCE1U115A	UCRTK	AM/FM チューナ	
12	V6782400	AM/FM TUNER	TFCE1E317A	ABGL	AM/FM チューナ	
* 15	X4203A00	POWER TRANSFORMER		J	電源トランス	
* 15	X4236A00	POWER TRANSFORMER		UC	電源トランス	
* 15	X4205A00	POWER TRANSFORMER		R	電源トランス	
* 15	X4206C00	POWER TRANSFORMER		TK	電源トランス	
* 15	X4207A00	POWER TRANSFORMER		A	電源トランス	
* 15	X4237A00	POWER TRANSFORMER		BGL	電源トランス	
* 16	WB211800	POWER CABLE	2m	J	パワーコードASSY	
* 16	WB120700	POWER CABLE	2m	UC	パワーコードASSY	
* 16	WB211900	POWER CABLE	2m	R	パワーコードASSY	
* 16	WB120600	POWER CABLE	2m	T	パワーコードASSY	

* New Parts * 新規部品(マーク#の部品は、基板に含まれません)

Schm Ref.	PART NO.	Description	Remarks	Markets	部 品 名	Rank
* 16	WB212000	POWER CABLE	2m	K	パワーコードASSY	
* 16	WB212100	POWER CABLE	2m	A	パワーコードASSY	
* 16	WB212200	POWER CABLE	2m	B	パワーコードASSY	
* 16	WB212300	POWER CABLE	2m	GL	パワーコードASSY	
17	V2438700	CORD STOPPER	10P1		コードストッパー	
23	MF115140	FLEXIBLE FLAT CABLE	15P 140mm P=1.25		カード電線 C & C	
* 101	WB872800	TOP COVER		GD	トップカバー	
* 101	WA791900	TOP COVER		BL	トップカバー	
* 101	WB873000	TOP COVER		SI	トップカバー	
* 103	WA794500	REAR PANEL		AX340	リアパネル	
* 103	WA793200	REAR PANEL		V340	リアパネル	
* 103	WA793100	REAR PANEL		V340	リアパネル	
* 103	WA793300	REAR PANEL		V340	リアパネル	
* 103	WA793500	REAR PANEL		V340	リアパネル	
* 103	WA793600	REAR PANEL		V340RDS	リアパネル	
* 103	WA793800	REAR PANEL		5630	リアパネル	
* 103	WB031100	REAR PANEL		5630	リアパネル	
* 103	WA794000	REAR PANEL		5630	リアパネル	
* 103	WA794100	REAR PANEL		5630	リアパネル	
* 103	WA794300	REAR PANEL		5630	リアパネル	
* 109	WA796100	SUPPORT, PCB			サポート/PCB	
* 120	V0042500	LEG	D60/H21	V340/5630GD	レッグ (GD)	
* 120	VS025000	LEG (HS)	D60/H21	V340BL/SI, 5630SI	レッグ (HS)	
* 120	VV544300	LEG (BL)	D60/H21	5630BL	レッグ (BL)	
* 121	WA795400	KNOB D44		GD	ノブ D 4 4	
* 121	WA795300	KNOB D44		BL	ノブ D 4 4	
* 121	WA795600	KNOB D44		SI	ノブ D 4 4	
* 122	WA795800	BUTTON/D6		GD	ボタン/D 6	
* 122	WA795700	BUTTON/D6		BL	ボタン/D 6	
* 122	WA796000	BUTTON/D6		SI	ボタン/D 6	
* 150	VU590000	BINDING TIE	CBTD001B		インシュロックタイ	
* 151	WB870100	DAMPER			ダンパー/サイド	
* 152	V7616600	DAMPER	SCREW MASK		ダンパー	
160	VN413300	BIND HEAD BONDING B-T. SCREW	3x8 MFZN2BL		ボンディングBタイトネジ	01
163	EP600250	BIND HEAD B-TITE SCREW	3x8 MFZN2Y		バインドBタイトネジ	01
164	EG330030	BIND HEAD SCREW	3x6 MFC2BL		バインド小ネジ	01
165	EP630220	BIND HEAD P-TITE SCREW	3x8 MFZN2BL		バインドPタイトネジ	
167	VT669300	PW HEAD B-TITE SCREW	3x8-8 MFC2		PWヘッドBタイトネジ	
168	VT669400	PW HEAD B-TITE SCREW	3x15-8 MFC2		PWヘッドBタイトネジ	
170	21991500	PW HEAD S-TITE SCREW	4x8-10 MFC2BL		PWヘッドSタイトネジ	01
171	VD069600	PW HEAD S-TITE SCREW	4x8-10 MFN133	GD, SI	PWヘッドSタイトネジ	01
171	21991500	PW HEAD S-TITE SCREW	4x8-10 MFC2BL	BL	PWヘッドSタイトネジ	01
200	WA220300	ACCESSORIES			付属品	
200-1	AAX46580	REMOTE CONTROL	RAV300	RRC4001-1001LC	JUCRKTAL	リモコン
* 201	WA617700	BATTERY COVER	103RRC-244-01G	103RRC-244-01G	BG	電池蓋
201-1	AAX49660	REMOTE CONTROL	RAV16	RC1112921/00		リモコン
* 202	WB212500	BATTERY COVER	3139 224 22451			電池蓋
* 202	WB212500	ANTENNA, FM	1P 1.4m		JUCRKT	FMアンテナコード
* 202	WB212400	ANTENNA, FM	1P 1.4m		ABG	FMアンテナコード
* 202	VY972200	ANTENNA, FM	1P 1.4m		L	FMアンテナコード
* 203	WB212600	ANTENNA, AM LOOP	1P 1.0m		JUCRKTABG	AMループアンテナ
* 203	VR248500	ANTENNA, AM LOOP	1P 1.0m		L	AMループアンテナ
		BATTERY, MANGANESE	2PC R6CP			マンガン電池

* New Parts * 新規部品(マーク#の部品は、基板に含まれません)

1 ■ REMOTE CONTROL RAV16 (RX-V340RDS / HTR-5630RDS)

The schematic diagram is not available.
回路図は非公開です。

2

3

4

5

6

7

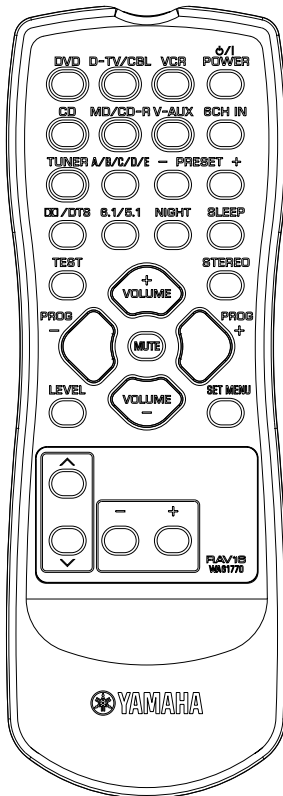

CUSTOM CODE: 7A

Key No.	Key Name	Data Code	Key No.	Key Name	Data Code
1	DVD	C1	18	VOLUME +	1A
2	D-TV/CBL	54	19	STEREO	56
3	VCR	0F	20	PROG -	59
4	POWER	1F	21	MUTE	1C
5	CD	15	22	PROG +	58
6	MD/CD-R	C9	23	LEVEL	86
7	V-AUX	55	24	VOLUME -	1B
8	6CH INPUT	87	25	SET MENU	9C
9	TUNER	16	26	^	98
10	A/B/C/D/E	12	27	_____	_____
11	PRESET -	11	28	_____	_____
12	PRESET +	10	29	_____	_____
13	DQ / DTS	90	30	∨	99
14	6.1 / 5.1	97	31	-	53
15	NIGHT	95	32	+	52
16	SLEEP	57	33	_____	_____
17	TEST	85			

**RX-V340/RX-V340RDS/
HTR-5630/HTR-5630RDS/DSP-AX340**

