

AM/FM STEREO TUNER TX-350/TX-350L

SERVICE MANUAL

■ FRONT PANEL

TX-350

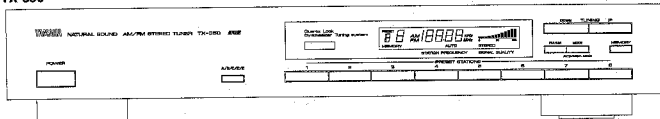

TX-350L

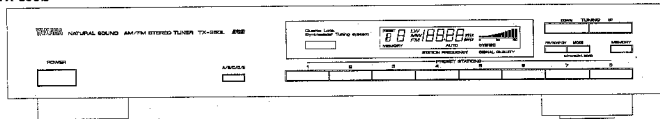

IMPORTANT NOTICE

This manual has been provided for the use of authorized Yamaha Retailers and their service personnel. It has been assumed that basic service procedures inherent to the industry, and more specifically Yamaha Products, are already known and understood by the users, and have therefore not been restated.

WARNING: Failure to follow appropriate service and safety procedures when servicing this product may result in personal injury, destruction of expensive components and failure of the product to perform as specified. For these reasons, we advise all Yamaha product owners that all service required should be performed by an authorized Yamaha Retailer or the appointed service representative.

IMPORTANT: The presentation or sale of this manual to any individual or firm does not constitute authorization, certification, recognition of any applicable technical capabilities, or establish a principle-agent relationship of any form.

The data provided is believed to be accurate and applicable to the unit(s) indicated on the cover. The research, engineering, and service departments of Yamaha are continually striving to improve Yamaha products. Modifications are, therefore, inevitable and specifications are subject to change without notice or obligation to retrofit. Should any discrepancy appear to exist, please contact the distributor's Service Division.

WARNING: Static discharges can destroy expensive components. Discharge any static electricity your body may have accumulated by grounding yourself to the ground bus in the unit (heavy gauge black wires connect to this bus).

IMPORTANT: Turn the unit OFF during disassembly and parts replacement. Retest all work before you apply power to the unit.

■ CONTENTS

TO SERVICE PERSONEL	1
INTERNAL VIEW	1
REAR PANELS	2
SPECIFICATIONS	3
DIMENSIONS	3
DISASSEMBLY PROCEDURES	3

ADJUSTMENTS	4-9
BLOCK DIAGRAM	10
WIRING	11
PRINTED CIRCUIT BOARD	12-13
SCHEMATIC DIAGRAM	14
PARTS LIST	15-20

■ TO SERVICE PERSONNEL

1. Critical Components Information.

Components having special characteristics are  marked and must be replaced with parts having specifications equal to those originally installed.

2. Leakage Current Measurement (For 120 V Model Only). When service has been completed, it is imperative that you verify that all exposed conductive surfaces are properly insulated from supply circuits.

- Meter impedance should be equivalent to 1500 ohm shunted by 0.15 μ F.
- Leakage current must not exceed 0.5 mA.
- Be sure to test for leakage with the AC plug in both polarities.

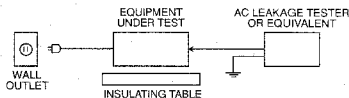

• POLARIZATION

This product is equipped with a polarized alternating current line plug (a plug having one blade wider than the other). This plug will fit into the power outlet only one way. This is a safety feature. (U.C model only)

■ WARNING: CHEMICAL CONTENT NOTICE!

The solder used in the production of this product contains LEAD. In addition, other electrical/electronic and/or plastic (where applicable) components may also contain traces of chemicals found by the California Health and Welfare Agency (and possibly other entities) to cause cancer and/or birth defects or other reproductive harm.

Avoid prolonged, unprotected contact between solder and your skin! When soldering, do not inhale solder fumes or expose eyes to solder/flux vapor!

If you come in contact with solder or components located inside the enclosure of this product, wash your hands before handling food.

DO NOT PLACE SOLDER, ELECTRICAL/ELECTRONIC OR PLASTIC COMPONENTS IN YOUR MOUTH FOR ANY REASON WHAT SO EVER!

■ INTERNAL VIEW

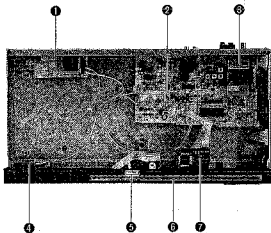

- ① Tuner circuit Board (2)
- ② Tuner circuit Board (1)
- ③ FM Front-end pack
- ④ Tuner circuit Board (4)
- ⑤ Tuner circuit Board (3)
- ⑥ OPERATION Circuit Board (1)
- ⑦ OPERATION Circuit Board (2)

■ REAR PANELS

• U.S.A. & Canadian Models of TX-350

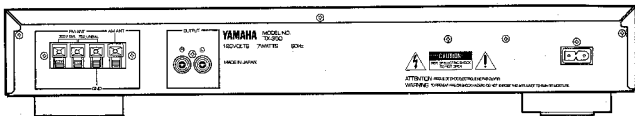

• North European Models of TX-350

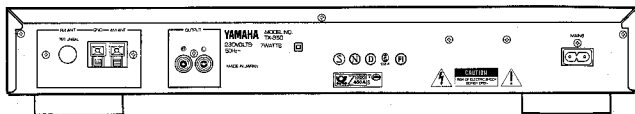

• Australian Model of TX-350

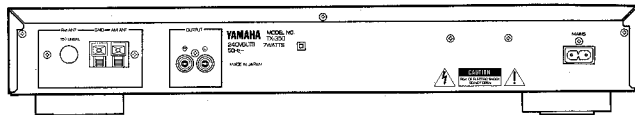

• General Model of TX-350

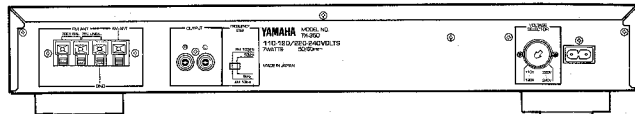

• British Model of TX-350L

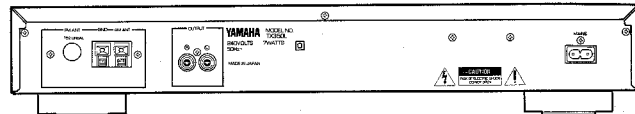

• European Model of TX-350L

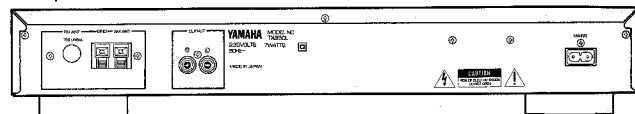

SPECIFICATIONS

FM SECTION

Tuning Range	
[U.S.A., Canada and General models]	87.5 to 107.9 MHz
[U.K., Australia, Europe and General models]	87.5 to 108 MHz
50 dB Quieting Sensitivity (IHF) [Except Europe model]	
75 ohms Mono	1.6 μ V (15.3 dB)
75 ohms Stereo	21 μ V (37.7 dB)
Usable Sensitivity	
[Except Europe model]	
75 ohms, 1 kHz, 100% mod.	(30 dB S/N Quieting) 0.8 μ V (9.3 dB)
[Europe model] (DIN)	
75 ohms Mono (S/N 26 dB)	0.9 μ V
75 ohms Stereo (S/N 46 dB)	24 μ V
Image Response Ratio	
[Except Europe model]	40 dB
[Europe model]	75 dB
IF Response Ratio	
[Except Europe model]	90 dB
[Europe model]	75 dB
Spurious Response Ratio	
[Europe model]	70 dB
AM Suppression Ratio	
[Europe model]	35 dB
Capture Ratio	
[Europe model]	1.5 dB
Alternate Channel Selectivity	
[Except Europe model]	85 dB
Selectivity (two signals, 40 kHz Dev., \pm 300 kHz)	
[Europe model]	70 dB
Signal-to-Noise Ratio	
[Except Europe model] (IHF)	
Mono	82 dB
Stereo	76 dB

[Europe model] (DIN-Weighted)	
Mono (40 kHz Dev.)	75 dB
Stereo (40 kHz Dev.)	70 dB
Harmonic Distortion (1 kHz)	
[Except Europe model]	
Mono/Stereo	0.1%/0.2%
[Europe model (40 kHz Dev.)]	
Mono/Stereo	0.1%/0.2%
Stereo Separation	1 kHz 40 dB
Frequency Response	
[Except Europe model]	
30 Hz to 15 kHz	0 \pm 0.5 dB
[Europe model]	
30 Hz to 13 kHz	0 \pm 0.5 dB
20 Hz to 15 kHz	0 \pm 1.5 dB

AM (MW) SECTION

Tuning Range	
[U.S.A., Canada and General models]	530 to 1,710 kHz
[U.K., Australia and Europe models]	
[U.S.A., Canada and General models]	531 to 1,611 kHz
Usable Sensitivity	
[U.S.A., Canada and General models]	200 μ V/m
[U.K., Australia and Europe models]	32 dB
Signal-to-Noise Ratio	
[U.S.A., Canada and General models]	50 dB
[U.K., Australia and Europe models]	40 dB
Spurious Response Ratio	
[U.S.A., Canada and General models]	50 dB
[U.K., Australia and Europe models]	0.3%

AM (LW) SECTION (TX-350L only)

Tuning Range	
[U.S.A., Canada and General models]	153 to 288 kHz
Usable Sensitivity	
[U.S.A., Canada and General models]	400 μ V/m
[U.K., Australia and Europe models]	32 dB

Signal-to-Noise Ratio	50 dB
Image Response Ratio	30 dB
Spurious Response Ratio	45 dB
Harmonic Distortion; 400 Hz	0.3%

AUDIO SECTION

Output Level/Impedance	
FM (100 % mod., 1 kHz)	
[Except Europe model]	500 mV/2.2 k-ohms
[Europe model (40 kHz Dev.)]	
AM (MW) (30% mod. 400 Hz)	400 mV/2.2 k-ohms
AM (LW) (30% mod. 400 Hz)	150 mV/2.2 k-ohms
[TX-350L only]	150 mV/2 k-ohms

GENERAL

Power Supply	
U.S.A. and Canada models	120V, 60 Hz
Europe model	230V, 50 Hz
U.K. and Australia models	240V, 50 Hz
General model	110-120/220-240V, 50/60 Hz
Power Consumption	
[U.S.A., Canada and General models]	7W
Dimensions (W x H x D)	
[U.S.A., Canada and General models]	435 x 76 x 237.5 mm
[U.K., Australia and Europe models]	(17-1/8" x 3" x 9-3/8")
Weight	
[U.S.A., Canada and General models]	2.2 kg (4 lbs. 13 oz.)
Accessories	
[U.S.A., Canada and General models]	AM loop antenna
[U.S.A., Canada and General models]	indoor FM antenna
[U.S.A., Canada and General models]	Connection cords

Specifications subject to change without notice.

DIMENSIONS

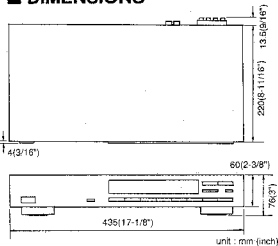

DISASSEMBLY PROCEDURES

1. Remo of Top Cover

Remove 4 screws ① and 1 screw ②, and slide the Top cover back.

2. Removal of Front Panel

- Remove the log by removing the 2 screws ③.
- Remove 6 screws ④ and 2 connectors, and pull the Front Panel forward.

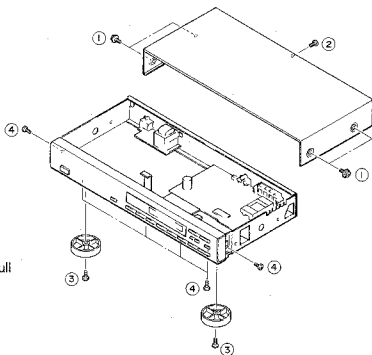

■ ADJUSTMENTS

1. Before adjustment

- 1) After the power switch is pushed on, wait for 5 minutes before measuring to be sure of the most stable operation.
- 2) Adjust the OSC coil and IFT with supplied screw driver.
- 3) Set the switches to the following positions.
TUNING MODE AUTO
- 4) Make the AM section adjustments the FM section adjustment.
- 5) $0\text{dB}\mu = 1\mu\text{V}$ Ex: $60\text{dB}\mu = 1\text{mV}$
 $X\text{dB}\mu = (X + 11.2)\text{dBf}$ Ex: $70\text{dB}\mu = 81.2\text{dBf}$

2. Measuring instruments abbreviation

FM SG : FM signal generator
 SSG : Stereo signal generator
 AM SG : AM signal generator
 DIST. M : Distortion meter
 FC : Frequency counter
 ACVM : AC voltage meter
 DCVM : DC voltage meter

(POWER SUPPLY CHECK)

Check that the following voltages are obtained respectively across each test point and ground on tuner circuit.

Test Point	Rating or standard	Remark										
+10V (Q20 Emitter)	+10V $\pm 0.5\text{V}$	Make sure that AC line voltage comes within: <table border="1" style="margin-left: 20px;"> <thead> <tr> <th>Models</th> <th>AC line voltage</th> </tr> </thead> <tbody> <tr> <td>U, C</td> <td>120V $\pm 10\%$</td> </tr> <tr> <td>G, E</td> <td>230V $\pm 10\%$</td> </tr> <tr> <td>A, B</td> <td>240V $\pm 10\%$</td> </tr> <tr> <td>R</td> <td>110/120/220/240V $\pm 10\%$</td> </tr> </tbody> </table>	Models	AC line voltage	U, C	120V $\pm 10\%$	G, E	230V $\pm 10\%$	A, B	240V $\pm 10\%$	R	110/120/220/240V $\pm 10\%$
Models	AC line voltage											
U, C	120V $\pm 10\%$											
G, E	230V $\pm 10\%$											
A, B	240V $\pm 10\%$											
R	110/120/220/240V $\pm 10\%$											
+5.5V (Q19 Emitter)	+5.5V $\pm 0.5\text{V}$											
+5V (D5 Cathode)	+5V $\pm 0.25\text{V}$											

• TEST POINTS

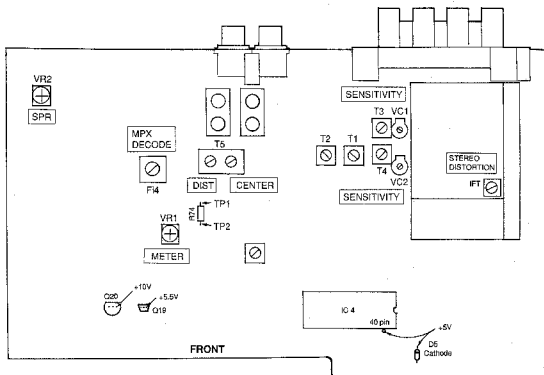

(Confirmation of preset)

- Turn the POWER switch on while pressing the preset keys "1", "2" and "3" simultaneously. Confirm that the frequencies described below is changed to the preset values. (Press P4 to reset the test mode. To preset, leave the keys as they are.)
- Total of 40 stations, P1 to P8 for each A to E are reset to the preset value.

		P1	P2	P3	P4	P5	P6	P7	P8
A	U, C, R	87.5M	95.1	98.1	101.5	107.9	88.1	106.1	107.9
	A, B, G, E, R	87.5k	95.1	98.1	101.5	108.0	88.1	106.1	107.9
B	U, C, R	630k	1080	1440	530	1710	900	1350	1400
	A, B, G, E, R	630k	1080	1440	531	1611	900	1350	1404
C	U, C, R, A, G	87.5M	90.1	95.1	98.1	101.5	107.9	88.1	106.1
	B, E	153k	171	225	270	288	180	207	252
D	U, C, R, A, G	630k	1080	1440	530	1710	900	1350	1400
	B, E	87.5M	90.1	95.1	98.1	101.5	108.0	88.1	106.1
E	U, C, R, A, G	87.5M	90.1	95.1	98.1	101.5	107.9	88.1	106.1
	B, E	630k	1080	1440	531	1611	900	1350	1404

- Only for B and E models, LW frequency band is reset to the preset value. (See pages 1 to 8.)
- For the R model, AM frequency step 9 kHz to (from) 10 kHz, and FM frequency step 100 kHz to (from) 50 kHz can be switched.
- Setting of the Function
The mode is changed to "AUTO".

CAUTION :

Using a table as shown below, write down the content of the memory preset in the tuner before setting to the test signal program mode.
(This is because setting to the test signal program mode sets the tuner memory content in the state preset by the manufacturer and erases all the memory preset by the user.)
Upon completion of the test signal program, set to the tuner mode again and enter the preset memory as written in the table.

Preset Group	P1	P2	P3	P4	P5	P6	P7	P8
A								
B								
C								
D								
E								

(Confirmation of LCD unit)**Confirmation of the display**

- The test mode is entered and all the segments of the LCD light when the POWER switch is turned on while pressing "P1", "P2" and "P3" simultaneously.
- After 1, the display mode is changed by pressing the following keys.
 - P1 All lit mode (All the segments are lit)
 - P2 All turned off mode (All the segments are turned off)
 - P3 "8" is lit at the third position from the right.
 - P4 The test mode is switched to normal mode.

(FM TUNER SECTION)

- Use 19 kHz L.P.F. to measure the output.
- 100 % modulation means that the Frequency Deviation is 75 kHz. (R, U, C, A, B)
- For the G model, Frequency Deviation is 40 kHz.
- For the G, B models, install the Matching Transformer and connect FM SG.

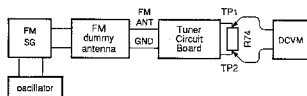
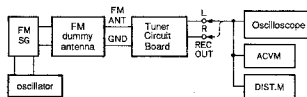
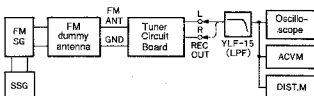
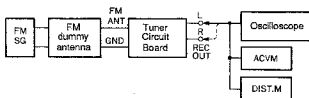
● Connection diagram (Measuring instruments)**1) Discriminator balance adjustment****2) Monaural distortion adjustment****3) Stereo distortion adjustment/separation adjustment****4) Sensitivity Verification**

Step	Adjustment item	Signal (ANT IN)	Reception frequency	Adjusted point	Test point	Rating
1	Rough adjustment of discriminator balance	FM ANT (75Ω) 98.1MHz 70dBμ MONO 100Hz 100% modulation	98.1MHz (A-P3)	T5 (SENER)	Both ends of R74 (TP1-TP2)	DC 0V±100mV
2	Rough adjustment of monaural distortion	Same as Step 1.	98.1MHz (A-P3)	T5 (MONO)	OUT PUT L, R	Minimize the distortion.
3	Fine adjustment of discriminator balance	Same as Step 1.	98.1MHz (A-P3)	T5 (SENER)	Both ends of R74 (TP1-TP2)	DC 0V±10mV
4	Fine adjustment of monaural distortion	Same as Step 1.	98.1MHz (A-P3)	T5 (MONO)	OUT PUT L, R	Minimize the distortion (to 41dB or less).
5	Verification of discriminator balance	Same as Step 1.	98.1MHz (A-P3)	T5 (MONO)	Both ends of R74 (TP1-TP2)	DC 0V±10mV
6	Stereo distortion	FM ANT (75Ω) 98.1MHz 70dBμ Stereo L or R 1kHz, 100% modulation	98.1MHz (A-P3) *Tuning mode should be AUTO.	Front end IFT	OUT PUT L, R	Distortion should be minimized (-33dB or less) *STEREO indicator should light. * Note that over-turning IFT will reduce sensitivity.
7	Verification of monaural distortion	FM ANT (75Ω) 98.1MHz 70dBμ MONO 1kHz, 100% modulation	98.1MHz (A-P3)		OUT PUT L, R	41dB or less
8	Verification of sensitivity	FM ANT (75Ω) 88.1MHz 98.1MHz 106.1MHz MONO 1kHz, 100% modulation	88.1MHz (A-P6) 98.1MHz (A-P3) 106.1MHz (A-P7)		ANT (75Ω)	Set the tuning mode to MANL MONO. S/N should be 30dB at each frequency of 88.1MHz, 98.1MHz, and 106.1MHz. Check to ensure that the voltage at the ANT terminal is 3dBμ or less.
9	Separation	FM ANT (75Ω) 98.1MHz 70dBμ Stereo L or R 1kHz, 100% modulation	98.1MHz (A-P3)	VR2	OUT PUT L, R	With SSG output at L or R, the signal leakage level at the other channel should be minimized. 28dB or more
10	Signal meter	FM ANT (75Ω) 98.1MHz 45dBμ MONO 1kHz 30% modulation -10dBμ or less	98.1MHz (A-P3)	VR1		Adjust so that all signal meters light. Check to ensure that signal meters turn OFF.
11	Verification of auto tuning	FM ANT (75Ω) 98.1MHz 26dBμ STEREO L or R 1kHz 30% modulation	98.1MHz (A-P3)			<ul style="list-style-type: none"> • Automatic reception should be available when the tuning key is moved UP and DOWN. • The stereo indicator should light. • Voice muting should be applied during tuning.

(AM TUNER SECTION)

- Connect the AM loop antenna to the AM ANT terminal.
- Connect the AM dummy antenna for adjustment to AM AG.
- Check that the AM SG precision is within ± 0.1 kHz.

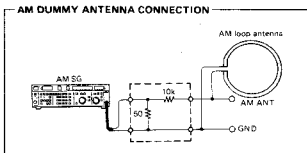
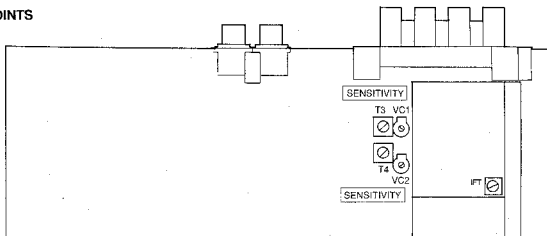
**• TEST POINTS**

Step	Item to be adjusted	Connection terminal	Instrument required	Adjustment locations	Adjustment method	Rating or standard
1	Sensitivity		AM dummy antenna AM SG 630kHz (MW) 1440kHz (MW) 171kHz (LW) 270kHz (LW) 50dBu MONO 400Hz 30% MOD.	T3 VC1 T4 VC2	Adjust T3 at 630kHz and VC1 at 1440kHz to make the output reading maximum when the preset CH B-1, B-3, C-2, and C-4 are received accordingly. (Adjust T4 at 171kHz and VC2 at 270kHz.)	Adjust 630kHz and 1440kHz for U, C, R, A and G model.
		OUTPUT	ACVM			
2	Verification of sensitivity	AM ANT	AM dummy antenna AM SG 630kHz 1080kHz 1440kHz 171kHz 225kHz 270kHz 60dBu 400Hz, 30% MOD.		Find the AM loop antenna to the AM ANT terminal. Verify that the each frequencies is received with sensitivity of under 60dBu when the preset CH B-1, B-2, B-3, C-2, C-3, C-4 are received accordingly.	60dBu or less
		OUTPUT	ACVM			
3	Verification of Signal meter	AM ANT	AM dummy antenna AM SG 1080kHz 225kHz 100dBu 400Hz, 30% MOD.		All signal quality indicators lights up.	
4		AM ANT	AM dummy antenna AM SG 1080kHz 225kHz -10dBu 400Hz, 30% MOD.		Check that all the signal meters are turned off.	
5	Verification of auto-search	AM ANT	AM dummy antenna AM SG 1080kHz 225kHz 65dBu 400Hz, 30% MOD.		Check that auto search reception is possible with the UP/DOWN switch.	Tuning MODE → AUTO

(DIGITAL CONTROL SECTION)

Step	Confirmation item	Connection terminal	Instrument required	Operation key	Confirmation method	
0	Power mute			POWER SW	Confirm that the mute circuit is in operation when the POWER switch is turned ON/OFF.	
1	Preset memory	300Ω/75Ω FM ANT	FM SG, SSG 98.1MHz ± 1kHz 70dBμ STEREO, L, R 1kHz, 100% MOD.	FM, AM TUNING MODE TUNING (UP or DOWN) MEMORY PRESET STATION P1-P8 A/B/C/D/E	1. Receive FM 98.1MHz by means of auto search. 2. Press MEMORY key → MEMORY indicator flashes about 5 seconds. 3. Select A with A/B/C/D/E SW. → "A" lights. 4. Press P1 → "1" lights and MEMORY indicator goes off. MEMORY indicator goes OFF A1 indicator lights. 5. Receive AM 1090kHz 6. Press MEMORY key → MEMORY indicator flashes about 5 seconds. 7. Select B with A/B/C/D/E SW. → "B" lights. 8. Press P1 → "1" lights and MEMORY indicator goes off. MEMORY indicator goes OFF B1 indicator lights. 9. Press A1 and B1 and check that Content is read out properly. → A1 and B1 light.	
		AM ANT	AM SG AM dummy antenna 1090kHz ± 0.1kHz 80dBμ 400Hz, 30% MOD.			
2	Tuning modes	Same as step 1	Same as step 1	FM TUNING MODE TUNING (UP or DOWN)	Tune to FM 98.1MHz and check that during MAN/L/MONO reception FM is forced monaural. → AUTO indicator goes off. STEREO indicator goes off. Check that auto search stop when tuned. → AUTO indicator lights. STEREO indicator lights.	
3	Last station memory			PRESET STATION P1 A/B/C/D/E	1. Press A1 → FM 98.1MHz is shown. 2. Turn POWER key OFF. 3. After 5 seconds, turn POWER key on. 4. Check that A1 content is read out. → A1 indicator lights. FM 98.1MHz is displayed.	
					FM	87.5-107.9 MHz U, C, R 87.50-108.00 MHz A, B, G, E, R
					AM (MW)	530-1710 kHz U, C, R 531-1611 kHz A, B, G, E, R
	LW	153-288 kHz B, E only				
4	Reception frequency band confirmation				Check that the standard frequency band is searched when auto tuning in each band (FM/MW/LW) is performed.	
					FM	200 kHz U, C 100 kHz R 50 kHz A, B, G, E, R
					AM (MW)	10 kHz U, C, R 9 kHz A, B, G, E, R
					LW	1 kHz - B, E only
5	Frequency step confirmation				Check that frequency step in each band confirms the standard when the frequency is changed one step at the time during manual tuning.	

TX-350/TX350L

- LCD-8169B1JP(TX-350)/LCD81701BJP(TX-350L)

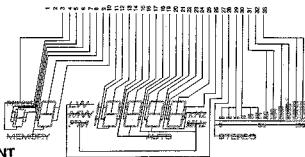
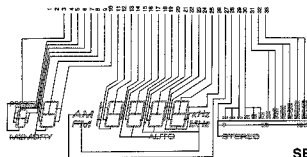
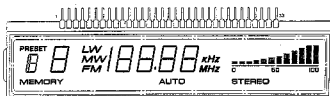
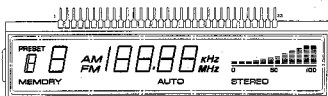

SEGMENT

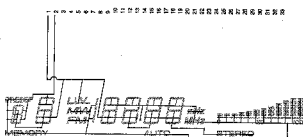
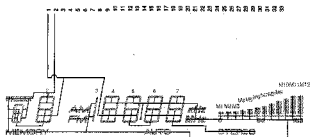

COMMON



NO	1	2	3	4	5	6	7	8	9	10	11	12	13	14	15	16	17	18	19
COM1	—	COM	PRESET	1f	1a	1bc	MEMORY	2f	2a	2b	3bc	4f	4a	4b	AUTO	5f	5a	5b	FM/STP
COM2	—	1d	1g	1j	1h	2d	2e	2g	2c	4d	4e	4g	4c	5d	5e	5g	5c	5d	5d

NO	20	21	22	23	24	25	26	27	28	29	30	31	32	33
COM1	6f	6a	6b	KHZ	7f	7a	7b	MW	1)	M1, M2	M3, M5	M7, M8	M9, M10	M11, M12
COM2	6e	6g	6c	7d	7e	7g	7c	LW	STEREO	—	—	—	—	—

1) 0 50 100

TX-350L only

TX-350 : AM, TX-350L : MW

- PK : VC21930 (FRONT END PACK)
[U, C, R, A, B, E models]
- PK : VE155800 (FRONT END PACK)
[G models]

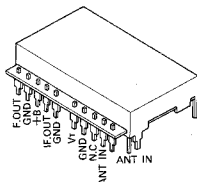

■ BLOCK DIAGRAM

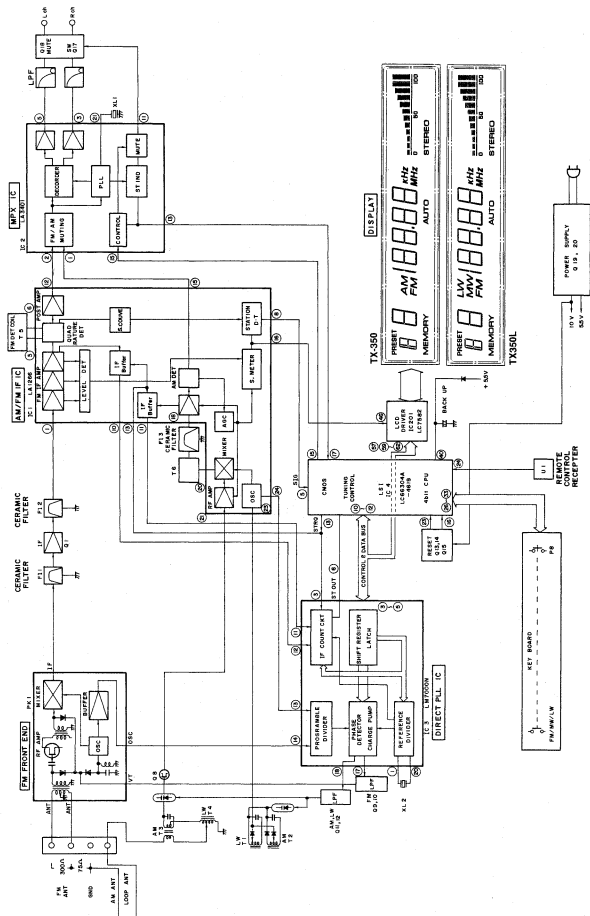

■ WIRING

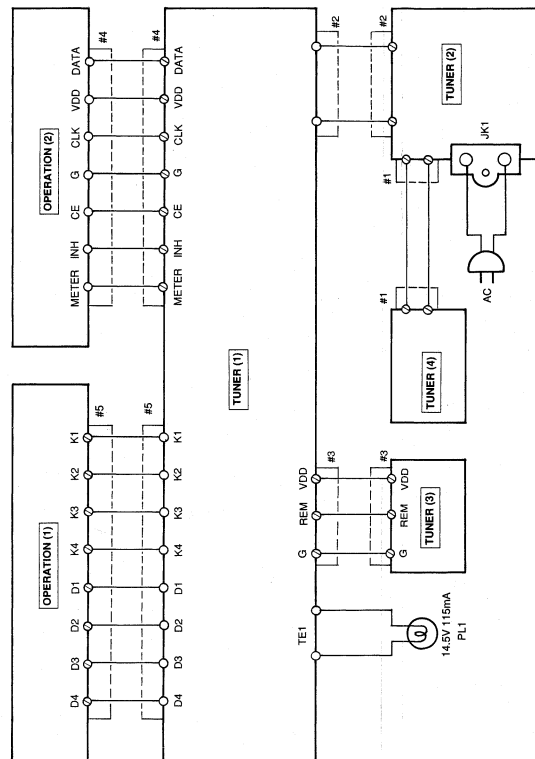

**TX-350/TX350L
PRINTED CIRCUIT BOARD**

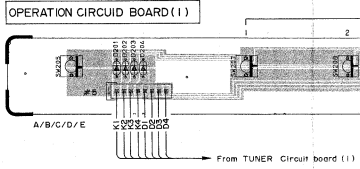
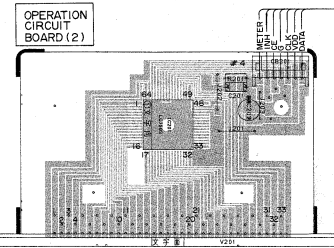
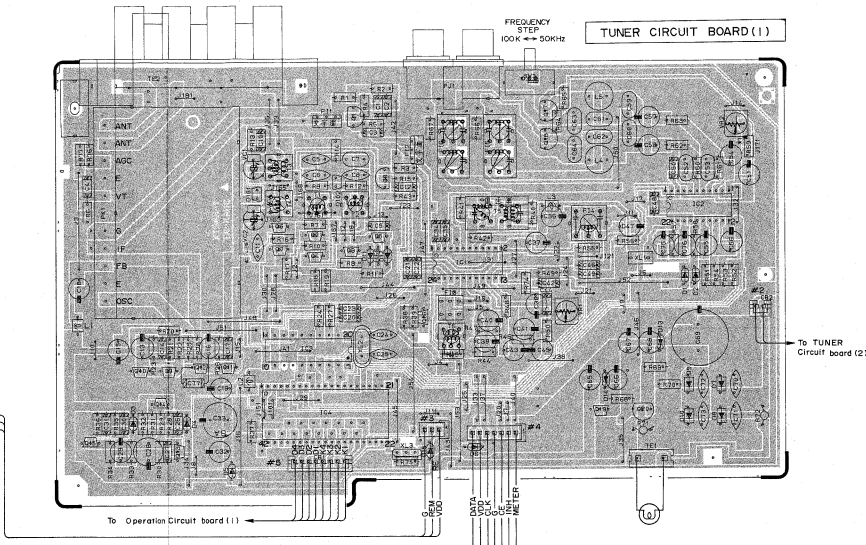
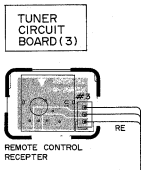
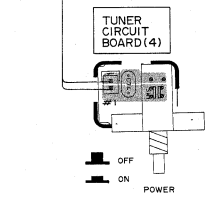
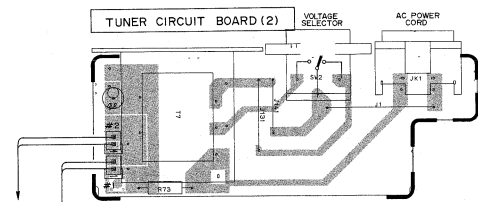

	U/C	R	A	B	S	E
1	F22	475K050		VK8050		
2	R61	VK1050		475K050	VK1050	
3	R96	OPEN		F50	OPEN	
4	R17	OPEN		F200K	OPEN	
5	J107	SHORT		OPEN		
6	J113	OPEN		SHORT		
7	R83	OPEN	VK5410	OPEN		
8	R86	100P			OPEN	100P
9	J103	SHORT				
10	R80	OPEN		4.7K	OPEN	
11	F14	OPEN				
12	R56	10K			20K	10K

	U/C	R	A	B	S	E
13	R59	20K			SHORT	20K
14	R52-53	① 510P		② 510P/510P	③ 510P	④ 510P
15	R60-61	50K			100K	50K
16	R55-60	2700P			OPEN	2700P
17	L4-5	33H			OPEN	33H
18	R51-52	1000P			OPEN	1000P
19	R53-54	3300P			OPEN	3300P
20	F15-6	OPEN			VK10750	OPEN
21						
22	F7	500P	VK577			
23	J101	OPEN	SHORT	OPEN		
24	J141	SHORT	OPEN	SHORT		

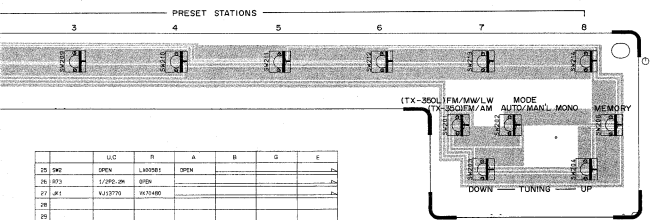

	U/C	R	A	B	S	E
13	R40	OPEN	VK50501	OPEN		
16	R73	1/20P-20K	OPEN			
27	J41	VK13770	VK74400			
28						
29						
30	J151	OPEN		SHORT	OPEN	SHORT
31	R25	OPEN		3.3K	OPEN	3.3K
32	R16	OPEN		4.7K	OPEN	4.7K
33	F10-11-19-18	OPEN		10K	OPEN	10K
34	R7-8	OPEN		20K	OPEN	20K
35	R6-7	OPEN		40K	OPEN	40K
36	R5	OPEN		40K	OPEN	40K
37	C17	OPEN		0.047/100	OPEN	0.047/100
38	R10	OPEN		1/750	OPEN	1/750
39	R11	OPEN		47P	OPEN	47P
40	R8	OPEN		10P	OPEN	10P
41	C5	OPEN		100P	OPEN	100P
42	R12-13	OPEN		100K	OPEN	100K
43	R6-10-12	OPEN		0.0010-0.5-T	OPEN	0.0010-0.5-T
44	R9-9-7	OPEN		4.53715-T	OPEN	4.53715-T
45	V42	OPEN		VK50737	OPEN	VK50737

	U/C	R	A	B	S	E
46	F1	OPEN		VK50140	OPEN	VK50140
47	L4	OPEN		VK50750	OPEN	VK50750
48	J161-163-166	SHORT			SHORT	OPEN
49	R12	OPEN		VK4440		
50	R9	OPEN		VK50750	VK4440	VK50750
51	F3	OPEN		VK50750	VK4440	VK50750
52	R13	OPEN			SP	SP
53	J167	OPEN			SHORT	OPEN
54	R10	10K			OPEN	10K
55	C77	0.01/16			OPEN	0.01/16
56	R15	1K		2.2K	1K	2.2K

PARTS LIST

■ ELECTRICAL PARTS

■ WARNING

Components having special characteristics are marked Δ and must be replaced with parts having specifications equal to those originally instead.

* Carbon resistors (1/8W or 1/4W) are not included in the ELECTRICAL PARTS list. For the parts No. of the carbon resistor, refer to last page.

Ref. No.	PART NO.	Description	部 品 名	Remarks	Markets	5/9
	VK646900	TUNER CIRCUIT BOARD	チューナーシート	TX-350	UC	
	VK646900	TUNER CIRCUIT BOARD	チューナーシート	TX-350	R	
	VK647000	TUNER CIRCUIT BOARD	チューナーシート	TX-350	A	
	VK847100	TUNER CIRCUIT BOARD	チューナーシート	TX-350L	B	
	VK647200	TUNER CIRCUIT BOARD	チューナーシート	TX-350	G	
	VK647300	TUNER CIRCUIT BOARD	チューナーシート	TX-350L	E	
	FA153100	MYLAR FILM CAP	1000pF 50V マイラコン	C81,62	UCRAG	
	FA153270	MYLAR FILM CAP	2700pF 50V マイラコン	C59,60	UCRAG	
	FA153390	MYLAR FILM CAP	3900pF 50V マイラコン	C83,64	UCRAG	
	FA154220	MYLAR FILM CAP	0.022uF 50V マイラコン	C74		
	U4652910	MYLAR FILM CAP	910pF 50V マイラコン	C52,53	UCR	
	U4652620	MYLAR FILM CAP	620pF 100V マイラコン	C52,53	ABE	
	U452390	POLYPROPYLENE FILM CAP	390pF 100V P Pコン	C52,53	G	
	U452390	POLYPROPYLENE FILM CAP	390pF 100V P Pコン	C7		
	F1544100	CERAMIC CAP	0.01uF 50V セラコン	C70-73		
	V4760200	CERAMIC CAP	5pF 50V (CH) セラコン	C8	BE	
	V4760800	CERAMIC CAP	15pF 50V (CH) セラコン	C8	UCRAG	
	V4761200	CERAMIC CAP	33pF 50V (CH) セラコン	C24,25		
	V4761400	CERAMIC CAP	47pF 50V (CH) セラコン	C11	BE	
	V4774600	CERAMIC CAP	120pF 50V (CH) セラコン	C6	BE	
	V4777600	CERAMIC CAP	180pF 50V (CH) セラコン	C5	BE	
	VF466700	CERAMIC CAP	47pF 50V 円筒セラコン	C20		
	VF466800	CERAMIC CAP	100pF 50V 円筒セラコン	C23		
	VF466800	CERAMIC CAP	100pF 50V 円筒セラコン	C46	UCRABE	
	VF466900	CERAMIC CAP	470pF 50V 円筒セラコン	C50		
	VF467000	CERAMIC CAP	1000pF 50V 円筒セラコン	C21,22		
	VF467300	CERAMIC CAP	0.01uF 16V 円筒セラコン	C1-4, 9, 10, 12, 26, 27, 30, 31, 34, 35, 42, 44		
	VF467300	CERAMIC CAP	0.01uF 16V 円筒セラコン	C77	UCRAG	
	VJ599000	CERAMIC CAP	0.047uF 16V 円筒セラコン	C14, 48, 40		
	VJ599000	CERAMIC CAP	0.047uF 16V 円筒セラコン	C17	BE	
	UJ817470	ELECTROLYTIC CAP	47uF 6.3V ケミコン	C32		
	UJ837100	ELECTROLYTIC CAP	10uF 16V ケミコン	C15, 18, 19, 36, 38, 39, 41, 47, 51, 54, 65-67		
	UJ837330	ELECTROLYTIC CAP	33uF 16V ケミコン	C29		
	UJ838100	ELECTROLYTIC CAP	100uF 16V ケミコン	C68		
	UJ838220	ELECTROLYTIC CAP	220uF 16V ケミコン	C28		
	UJ865470	ELECTROLYTIC CAP	0.47uF 50V ケミコン	C45, 76		
	UJ866100	ELECTROLYTIC CAP	1uF 50V ケミコン	C13, 55-58, 75		
	UJ866100	ELECTROLYTIC CAP	1uF 50V ケミコン	C16	BE	
	UJ866220	ELECTROLYTIC CAP	2.2uF 50V ケミコン	C37		
	UJ866330	ELECTROLYTIC CAP	3.3uF 50V ケミコン	C43		
	UJ866470	ELECTROLYTIC CAP	4.7uF 50V ケミコン	C40		
	UH149220	ELECTROLYTIC CAP	2200uF 25V ケミコン	C99		
	VB170100	ELECTROLYTIC CAP	4700uF 5.5V バッグアップケミコン	C33		
	VC463300	TRIMMER CAP	7pF ECR-HA007A11 トリマコン	VC1		
	VC37300	TRIMMER CAP	20pF ECR-HA020D11 トリマコン	VC2	BE	
	XD676001	POWER TRANSFORMER	電源トランス	T7	UC	
	XD677001	POWER TRANSFORMER	電源トランス	T7	RABE	
	GE901850	CHIL. INDUCTOR	固定インダクター	L4,5	UCRAG	

* : New Parts (新種部品)

ランク : Japan only

△
△

Ref. NO.	PART NO.	Description	部 品 名	Remarks	Markets	ラック
	GE100470	HM COIL	4500Hz	AM 1 F T コイル	T6	
	VC218000	COIL, FM DETECT	10.7MHz	F M 検波コイル	T5	
	VC867400	COIL, OSC.	LW, 520kHz	O S C コイル	T1	BE
	YK648400	COIL, OSC.	MV, 118kHz	O S C コイル	T2	UCRAG
	VC867500	COIL, OSC.	MV, 132kHz	O S C コイル	T2	BE
	VC867600	COIL, ANTENNA	LW, 3.5MHz	A N T コイル	T4	BE
	YK648500	COIL, ANTENNA	MV, 340kHz	A N T コイル	T3	UCRAG
	VC867700	COIL, ANTENNA	MV, 3.5MHz	A N T コイル	T3	BE
	V1546100	COIL	220kHz	固定コイル	L1-3	
	HV454150	FLAME PROOF CARBON RESISTOR	15Ω 1/4W	不燃化カーボン抵抗	R72	△
	HV455120	FLAME PROOF CARBON RESISTOR	120Ω 1/4W	不燃化カーボン抵抗	R71	△
	HZ005110	CARBON RESISTOR	2.2KΩ 1/2W	カーボン抵抗	R73	UC
	IG158100	IC	LA3401	I C	IC2	
	XB700001	IC	LA1206	I C	IC1	
	X1583A00	IC	LC003D4A-4019	I C	IC4	
	XB818001	IC	LM7000N	I C	IC3	
	VF928500	LIGHT DETECTING MIDDLE	GP115611X	リモコン受光ユニット	U1	
	LA005610	VOLTAGE SELECTOR	HVW0206	電圧切替器	SW2	R
	VF541200	SLIDE SWITCH	SSSF11	スライドSW	SW3	R
	VC277200	MUSH SWITCH	2-2	プッシュSW	SW1	
	LA002000	LAPPING TERMINAL	2P 1-TYPE P#7.5	ラッピング端子	TE1	
	VE365200	ANTENNA TERMINAL	4P	アンテナ端子	TE2	UCR
	VE365000	ANTENNA TERMINAL/DIN	3P	アンテナ端子	TE2	ABGE
	VE366700	PIN JACK	2P	ピンジャック	FJ1	
	VJ137700	AC INLET		A C インレット	JK1	UC
	VK704800	AC INLET		A C インレット	JK1	RABGE
	VD004500	BASE PIN	PH 2P TE	ベースピン	CB2	
	VD005100	BASE PIN	PH 8P TE	ベースピン	CB1	
	VC193900	FRONT-END PACK, FM	TFFG1U117A	F M フロントエンドパック	PK1	UCRABE
	VE155800	FRONT-END PACK, FM	TFFG3E132A	F M フロントエンドパック	PK1	
	GE200530	FILTER	114kHz	L C フィルター	F14	G
	VJ123100	FILTER, MPX	TFB-2D	M P X フィルター	F15, 6	BE
	G0000560	CERAMIC FILTER	SFE10.7MS3GHY-A	セラミックフィルタ	F11, 2	
	VC219000	CERAMIC FILTER	SFZ450JL3	セラミックフィルタ	F13	
	Q0003800	QUARTZ CRYSTAL UNIT	7.2MHz	水晶振動子	XL2	
	G0000750	CERAMIC RESONATOR	18.96MHz CS8456F11	セラミック振動子	XL1	
	VE906000	CERAMIC RESONATOR	4MHz CST4.00MGV	セラミック振動子	XL3	
	VJ804000	PRE-SET POTENTIOMETER	B47KΩ	半固定V R	VR1, 2	
	VC218700	TRANSISTOR	2SA1317 R, S, T	トランジスタ	Q14, 16	
	VC218700	TRANSISTOR	2SA1317 R, S, T	トランジスタ	Q2-5, 7	BE
	IC209000	TRANSISTOR	2SC2090	トランジスタ	Q20	
	IC287820	TRANSISTOR	2SC2878 A, B	トランジスタ	Q17, 18	△
	V8433300	TRANSISTOR	2SC1809 H, W, P	トランジスタ	Q1	
	VC218900	TRANSISTOR	2SC3330 R, S, T	トランジスタ	Q9, 10, 13, 15, 19	
	VC218900	TRANSISTOR	2SC3330 R, S, T	トランジスタ	Q6, 11, 12	BE
	E1E104100	PET	2SK161 O, Y, GR	F E T	Q8	
	IF004600	DIODE	1SS133	ダイオード	D1-6, 15	
	IF004600	DIODE	1SS133	ダイオード	D11, 12	BE
	VH770800	DIODE	1SR139-100 T-32	ダイオード	D7-10	
	VG438100	ZENER DIODE	WZJ36.2C	ツェナーダイオード	D14	

* : New Parts (新規部品)

ラック : Japan only

TX-350/TX350L

Ref. NO.	PART NO.	Description	部 品 名	Remarks	Markets	ラック
	V6439600	ZENER DIODE	MTZJ10C	ツェナーダイオード	D13	
	1F002200	VAR VARIATOR DIODE	SVC321	A Mバクタターダイオード	D101,102	
	B8009510	GROUND METAL		ランド金具		
	VK628900	OPERATION CIRCUIT BOARD		オペレーションシート		UCRAG
	VK629000	OPERATION CIRCUIT BOARD		オペレーションシート		BE
	UA252880	KYLAR FILM CAP	880pF 50V	マイラーコン	C201	
	UB387100	ELECTROLYTIC CAP	10uF 16V	ケミコン	C202	
	XB417001	IC	LC7582	I C	IC201	
	VK276790	LCD	LC0810981JP	L C D 表示器	V201	UCRAG
	VK317300	LCD	LC0817081JP	L C D 表示器	V201	BE
	V6392900	TACT SWITCH	SKHVA4	タクト S W	SW201-214	
	V0005900	BASE PIN	PH	ベースピン	CB201	
	1F004600	DIODE	1S5133	ダイオード	D201-204	
	VE298900	REFLECTOR		リフレクタ		
	C8605620	PLASTIC RIVET	NO.1057	ブラリベット		
	VH272800	SHEET,DIFFUSION		シート		
	VF444500	CAP.LAMP		ランプキャップ		

* : New Parts (新規部品)

ラック : Japan only

TX-350/TX350L

TX-350/TX350L

■ EXPRODED VIEW

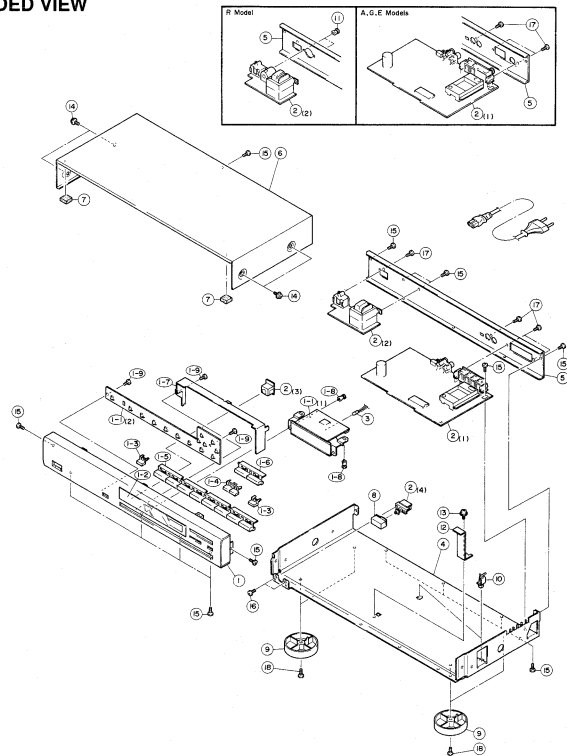

Ref. NO.	PART NO.	Description	部 品 名	Remarks	Markets	ラック
		ACCESSORIES	付属品			
	VG718700	PH PLUG CORD	1.0m ピンビンコード			
	VC421100	POWER CORD	7A 125V 2.0m 電源コード		IC	
	VE368800	POWER CORD	8A 250V 1.8m 電源コード		R	
	W0002160	POWER CORD	2.5A 250V 1.8m 電源コード		A	
	W0002150	POWER CORD	2.5A 250V 1.8m 電源コード		GE	
	VX815800	POWER CORD	2.5A 250V 1.8m 電源コード		B	
	VG804900	ANTENNA,FM	75Ω FMアンテナコード		UCR	
	VG805000	ANTENNA,FM	PAL FMアンテナコード		BAGE	
	VE306200	LOOP ANTENNA	JM ループアンテナ			

* : New Parts (新換部品)

ラック : Japan only

■ SCHEMATIC DIAGRAM

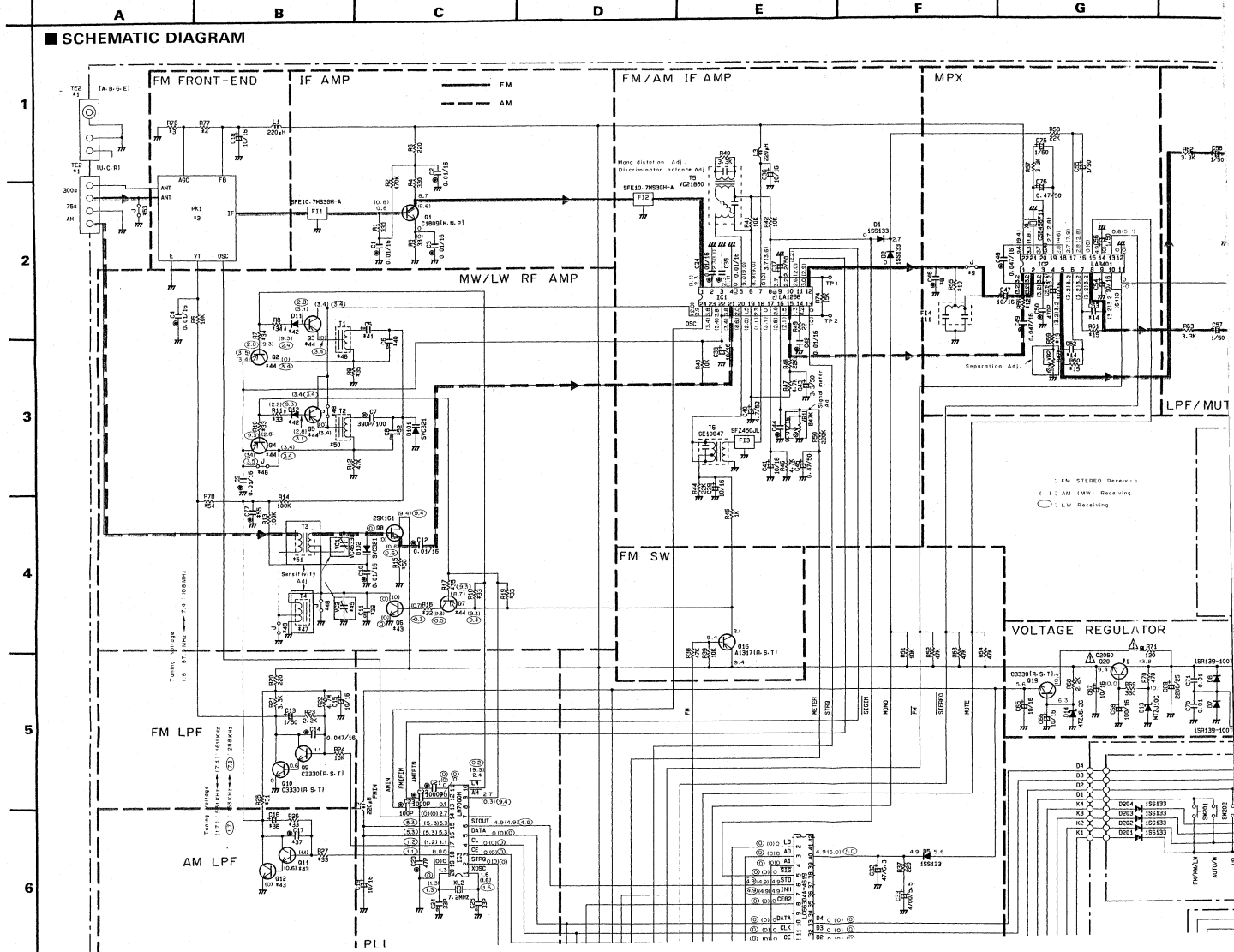

6
7
8
9
0

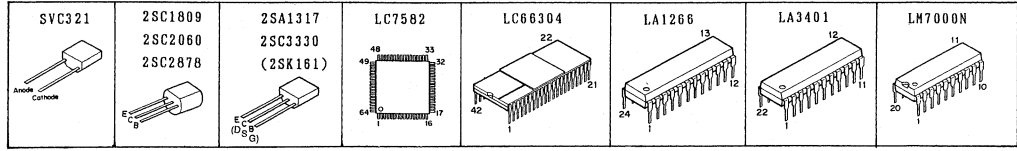
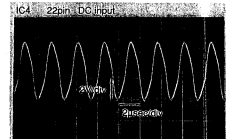
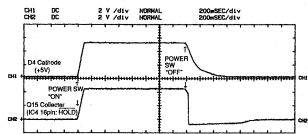
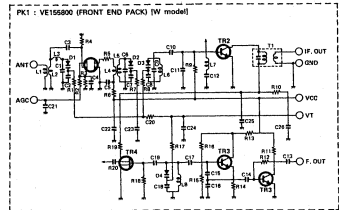
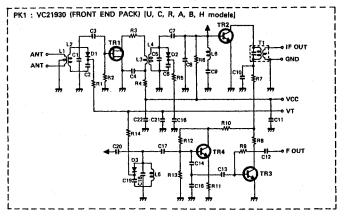
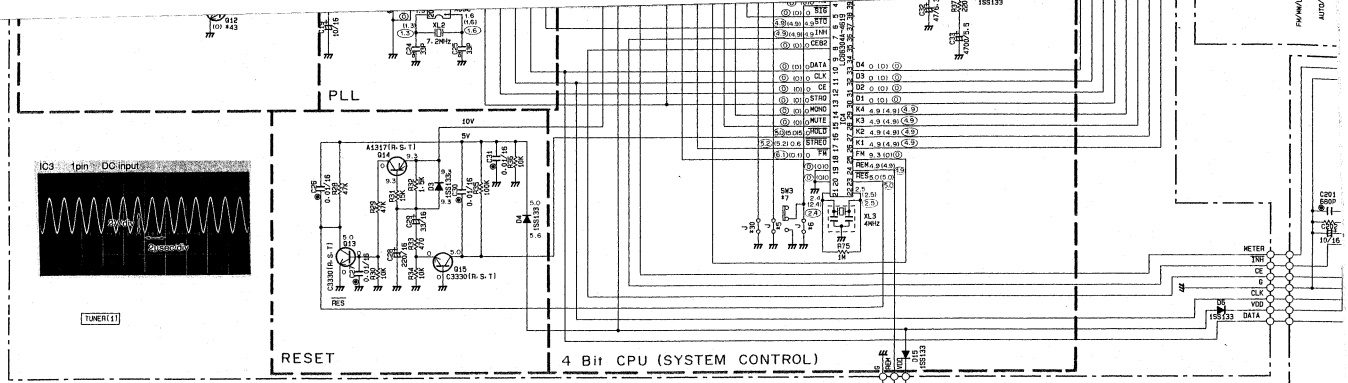

CAPACITOR	ISYMANTZ	PAISS NAME	REMARKS	PARTS NO.
NO MARK ELECTROLYTIC CAPACITOR				
NO MARK TANTALUM CAPACITOR				
NO MARK FERRIC CAPACITOR				
▲ JAPAN RADAR CERAMIC CAPACITOR				
○ POLYESTER FILM CAPACITOR				
○ POLYPROPYLENE FILM CAPACITOR				
○ MICA CAPACITOR				
● POLYPROPYLENE FILM CAPACITOR				
● ISOMETRODUCTIVE CERAMIC CAPACITOR				

RESISTOR	REMARKS	PARTS NO.
NO MARK CARBON FILM RESISTOR		
○ CARBON FILM RESISTOR		
▲ METAL FILM RESISTOR		
○ METAL FILM RESISTOR		
○ FUSE POWER CARBON		
○ COMMON METAL RES		
○ SEMI VARIABLE RES		
■ CHIP RESISTOR		

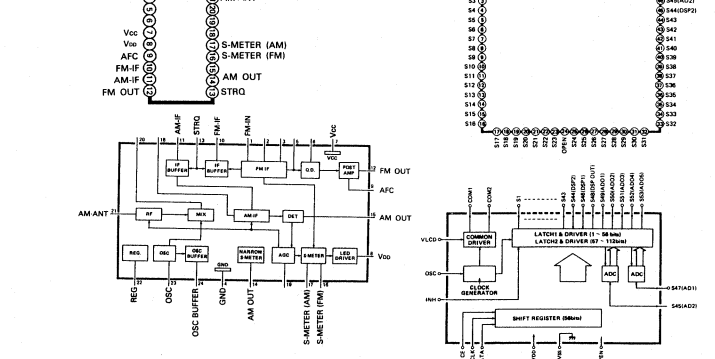
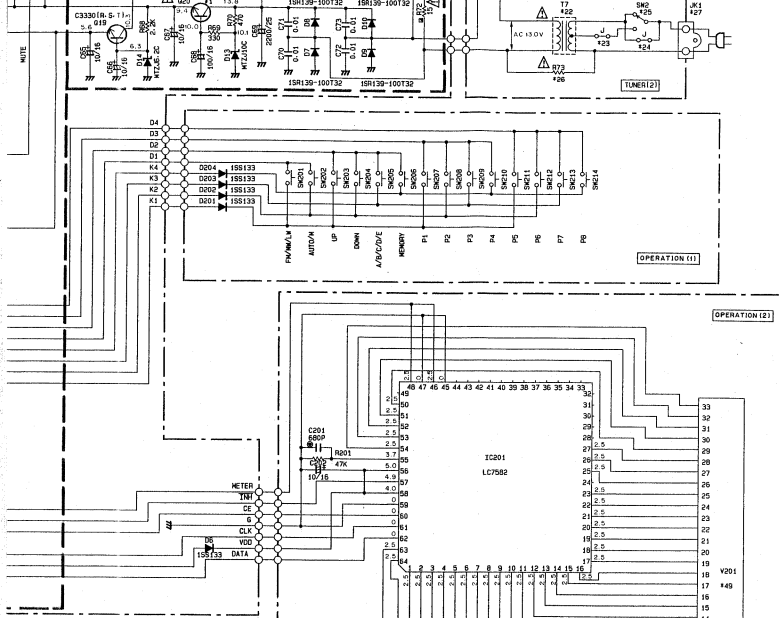

• IC4 : LC6304A-4619 (4 bit μ-com)

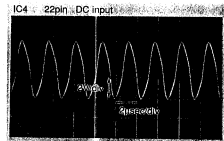
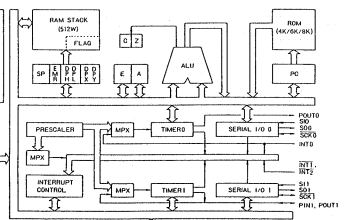
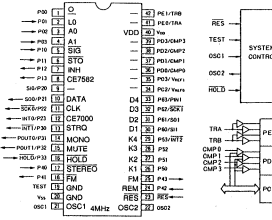

IC4 : 22pin DC input																					
1	2	3	4	5	6	7	8	9	10	11	12	13	14	15	16	17	18	19	20	21	22

RESISTOR	REMARKS	PARTS NAME
1	1/4W	RES CARBON FILM RESISTOR (1/4W)
2	1/4W	RES CARBON FILM RESISTOR (1/4W)
3	1/4W	RES CARBON FILM RESISTOR (1/4W)
4	1/4W	RES CARBON FILM RESISTOR (1/4W)
5	1/4W	RES CARBON FILM RESISTOR (1/4W)
6	1/4W	RES CARBON FILM RESISTOR (1/4W)
7	1/4W	RES CARBON FILM RESISTOR (1/4W)
8	1/4W	RES CARBON FILM RESISTOR (1/4W)
9	1/4W	RES CARBON FILM RESISTOR (1/4W)
10	1/4W	RES CARBON FILM RESISTOR (1/4W)
11	1/4W	RES CARBON FILM RESISTOR (1/4W)
12	1/4W	RES CARBON FILM RESISTOR (1/4W)
13	1/4W	RES CARBON FILM RESISTOR (1/4W)
14	1/4W	RES CARBON FILM RESISTOR (1/4W)
15	1/4W	RES CARBON FILM RESISTOR (1/4W)
16	1/4W	RES CARBON FILM RESISTOR (1/4W)
17	1/4W	RES CARBON FILM RESISTOR (1/4W)
18	1/4W	RES CARBON FILM RESISTOR (1/4W)
19	1/4W	RES CARBON FILM RESISTOR (1/4W)
20	1/4W	RES CARBON FILM RESISTOR (1/4W)
21	1/4W	RES CARBON FILM RESISTOR (1/4W)
22	1/4W	RES CARBON FILM RESISTOR (1/4W)

NOTICE
 (J) Japanese mode
 (U) U.S.A. mode
 (C) Canadian mode
 (A) Australian mode
 (E) European mode
 (B) British mode
 (G) German mode
 (S) SEMI VARIABLE RESISTOR
 (V) CHIP RESISTOR

Part No.	Part Name	Quantity
1	RES	20000
2	RES	20000

Pin No.	Pin Name	I/O	Function
1	P00	-	NC
2	P01	I	LC
3	P02	I	A0
4	P03	I	A1
5	P10	I	SIG
6	P11	I	STO
7	P12	0	INH
8	P13	0	CE7582
9	S/10P20	-	NC
10	SO0/P21	0	DATA
11	SK0/P22	0	CLK
12	INT0/P23	0	CE7000
13	INT1/P30	0	STRQ
14	POUT0/P31	0	MONO
15	POUT1/P32	0	MUTE
16	HOLD/P33	I	HOLD
17	P40	I	STEREO
18	P41	0	FM
19	TEST	I	GND
20	Vss	I	GND
21	OSC1	I	Clock input

Pin No.	Pin Name	I/O	Function
22	OSC2	0	Clock output
23	RES	I	Reset mode: L
24	P42	I	REM
25	P43	0	FM
26	P50	0	K1
27	P51	0	K2
28	P52	0	K3
29	INT2/P53	0	K4
30	SI1/P60	I	D1
31	SO1/P61	I	D2
32	SK1/P62	I	D3
33	PI1/P63	I	D4
34	VREF0/PC2	-	NC
35	VREF1/PC2	-	NC
36	CMPO/PD0	-	NC
37	CMPI/PD1	-	NC
38	CM2/PD2	-	NC
39	CM3/PD3	-	NC
40	VDD	I	VDD +5 V power input
41	TRA/PE0	-	NC
42	TRB/PE1	-	NC

CAUTION
 • Components having special characteristics are marked Δ and must be replaced with parts having specifications equal to those originally installed.
 • All voltages are measured with a 10MΩ/V DC electric voltmeter.
 • Schematic diagram is subject to change without notice.

G

H

I

J

K

L

M

N

TX-350/TX350L

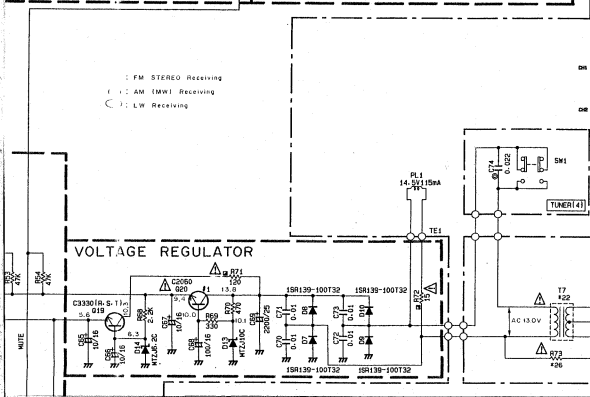
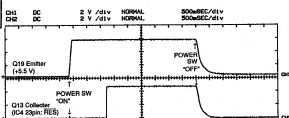
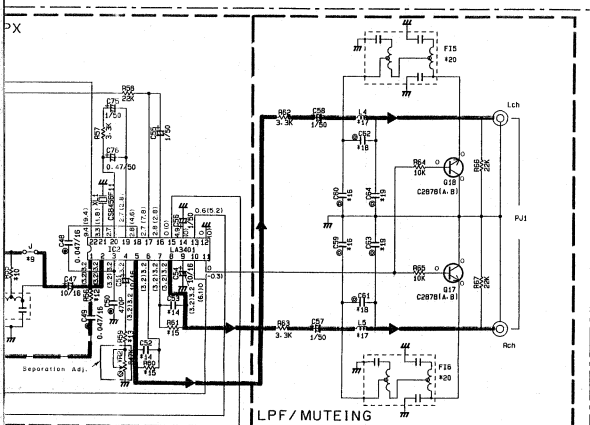

4	5	D C	R	A	B	E		U C	R	A	B	G	C
1	1E2	VE3550		VE3550			28						
2	1K1	VC1250		VC1250		VC1250	30	J151	OPEN		SH07	OPEN	SH07
3	1K6	OPEN		OPEN		OPEN	31	1G5	OPEN		3.3K	OPEN	3.3K
4	1K7	OPEN		OPEN		30K	32	1G6	OPEN		4.7K	OPEN	4.7K
5	J125	SH07	OPEN				33	1H1, 1H 19	OPEN		10K	OPEN	10K
6	J115	OPEN		SH07			34	1K 4	OPEN		10K	OPEN	10K
7	1K4	OPEN	VF54102	OPEN			35	1K 17	OPEN		10K	OPEN	10K
8	1C6	100P		OPEN	100P		36						
9	J181	SH07		OPEN	SH07		37	1J7	OPEN		0.04775	OPEN	0.04775
10	1G5	OPEN		4.7K	OPEN		38	1J8	OPEN		170	OPEN	170
11	1J4	OPEN		0.00033	OPEN		39	1J9	OPEN		10P	OPEN	10P
12	1G6	10K		20K	10K		40	1C8	OPEN		100P	OPEN	100P
13	1G9	20K		OPEN	20K		41	1C9	OPEN		100P	OPEN	100P
14	1G0 53	010P		0.000102	010P		42	1G1 02	OPEN		100023	OPEN	100023
15	1G0 41	00K		10K	00K		43	06 11 10	OPEN		C23070A 5 11	OPEN	C23070A 5 11
16	1G9 50	270P		OPEN	270P	OPEN	44	07 5 7	OPEN		A13170A 5 11	OPEN	A13170A 5 11
17	1A 2	OPEN		OPEN	OPEN	OPEN	45	1G2	OPEN		VC2970	OPEN	VC2970
18	1G1 02	100P		OPEN	100P	OPEN	46	1J2	OPEN		VC2870	OPEN	VC2870
19	1G3 54	200P		OPEN	200P	OPEN	47	1A	OPEN		VC2870	OPEN	VC2870
20	1F5 4	OPEN		VC12710	OPEN	VC12710	48						
21							49	1G31	VC2720	VC2720	VC2720	VC2720	VC2720
22	1F7	00075	00075				50	1J3	VC4540	VC4540	VC4540	VC4540	VC4540
23	J181	OPEN	SH07	OPEN			51	1J3	VC4540		VC4540	VC4540	VC4540
24	J181	SH07	OPEN	SH07			52	1G4	OPEN		10P	OPEN	10P
25	1K2	OPEN	LA0861	OPEN			53	1K3	OPEN		SH07	OPEN	SH07
26	1K3	L202 2K	OPEN				54	1K4	10K		OPEN	10K	OPEN
27	1K1	V2970	VC7040				55	1J7	0.0175		OPEN	0.0175	OPEN
							56	1A2	1K		0.2K	1K	0.2K

■ IC BLOCK

- IC2 : LA3401 (MPX)

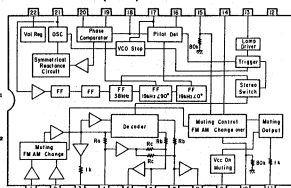

- IC3 : LM7000N (PLL)

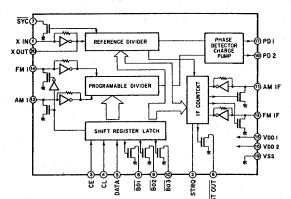

- IC1 : LA1266 (AM/FM IF)

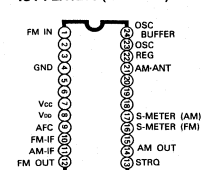

- IC201 : LC7582 (LCD Driver)

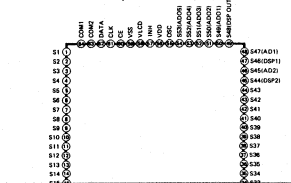

MECHANISM PARTS

Ref. NO.	PART NO.	Description	部 品 名	Remarks	Markets	ランク
1	VK688700	PANEL UNIT		パネルユニット	TX-350 BL	UCRAG
1	VK688900	PANEL UNIT		パネルユニット	TX-350 T	UCRAG
1	VK688800	PANEL UNIT		パネルユニット	TX-350L BL	BE
1	VK689000	PANEL UNIT		パネルユニット	TX-350L T	BE
1-1	VK628900	OPERATION CIRCUIT BOARD		オペレーションシート	TX-350	UCRAG
1-1	VK620000	OPERATION CIRCUIT BOARD		オペレーションシート	TX-350L	
1-2	VK431000	WINDOW		ウインドウ		BE
1-3	V1771700	BUTTON	A/B/C/D/E, HERO	ボタン	BL	
1-3	V1772100	BUTTON	A/B/C/D/E, HERO	ボタン	T	
1-4	V1771800	BUTTON	FM/AM, MODE	ボタン	BL	
1-4	V1772200	BUTTON	FM, AM, MODE	ボタン	T	
1-5	V1435700	BUTTON		ボタン	BL	
1-5	V1437600	BUTTON		ボタン	T	
1-6	V1435800	BUTTON	UP/DOWN	ボタン	BL	
1-6	V1437700	BUTTON	UP/DOWN	ボタン	T	
1-7	V.2292200	PLATE		フレーム		
1-8	CB605020	PLASTIC RIVET	NO.1057	ブラリベット		
1-9	E1130080	BIND HEAD P-TITE SCREW	3x8 ZMC2-Y	バインドPタイトネジ		
2	VK646800	TUNER CIRCUIT BOARD		チューナーシート		UC
2	VK646900	TUNER CIRCUIT BOARD		チューナーシート		E
2	VK647000	TUNER CIRCUIT BOARD		チューナーシート		A
2	VK647100	TUNER CIRCUIT BOARD		チューナーシート		B
2	VK647200	TUNER CIRCUIT BOARD		チューナーシート		G
2	VK647300	TUNER CIRCUIT BOARD		チューナーシート		E
3	VE228000	LAMP	115mA 14.5V	ランプ		
4	VE300100	CHASSIS		シャーシ		
5	VK640900	REAR PANEL		リヤパネル		UC
5	VK641000	REAR PANEL		リヤパネル		R
5	VK641100	REAR PANEL		リヤパネル		A
5	VK641200	REAR PANEL		リヤパネル		G
5	VK641300	REAR PANEL		リヤパネル		B
5	VK641400	REAR PANEL		リヤパネル		E
6	VE300000	TOP COVER		トップカバー	BL	
6	VF342400	TOP COVER		トップカバー	T	
7	VF274900	DAMPER	15x15x8	ダンパー		
8	VH841900	BUTTON	POWER	ボタン	BL	
8	VH842000	BUTTON	POWER	ボタン	T	
9	VF630400	LEG		レッグ	BL	
9	V1031600	LEG		レッグ	T	
10	VA772900	P.C.B SUPPORT		基板サポート		
11	CB609200	PLASTIC RIVET		プラスチックリベット		R
12	VJ083400	SPACER		スペーサ		
13	EK335010	BW HEAD SCREW	3x6-8 FCRM3-BL	BWヘッドタッピングネジ		
14	EK305000	BW HEAD SCREW	4x8-10 FCRM3-BL	BWヘッドSタイトネジ	BL	
14	EX601150	BW HEAD S-TITE SCREW	4x8-10 FNM3-BL	BWヘッドSタイトネジ	T	
15	E1330080	BIND HEAD TAPPING SCREW	3x8 FCRM3-BL	バインドタッピングネジ	PACK	
16	E1330056	BIND HEAD SCREW	3x6 FCRM3-BL	バインド小ネジ	PACK	
17	EX601900	BIND HEAD BONDING TAP. SCREW	3x8 FCRM3-BL	ボンディングBタイトネジ		
18	E1330065	BIND HEAD B-TITE SCREW	3x6 FCRM3-BL	バインドBタイトネジ	PACK	

* : New Parts (新種部品)

ランク : Japan only

Parts List for Carbon Resistors

Value	1/4W Type Part No.	1/6W Type Part No.	Value	1/4W Type Part No.	1/6W Type Part No.
1.0 Ω	HJ35 3100	HF853100	12 KΩ	HJ35 7120	HF85 7120
1.8 Ω	HJ35 3180	*	15 KΩ	HJ35 7150	HF85 7150
2.2 Ω	HJ35 3220	HF853220	18 KΩ	HJ35 7180	HF85 7180
3.3 Ω	HJ35 3330	HF85 3330	22 KΩ	HJ35 7220	HF85 7220
4.7 Ω	HJ35 3470	HF853470	27 KΩ	HJ35 7270	HF85 7270
5.6 Ω	HJ35 3560	HF853560	33 KΩ	HJ35 7330	HF85 7330
10 Ω	HJ35 4100	HF854100	39 KΩ	HJ35 7390	HF85 7390
15 Ω	HJ35 4150	HF854150	47 KΩ	HJ35 7470	HF85 7470
22 Ω	HJ35 4220	HF854220	56 KΩ	HJ35 7560	HF85 7560
27 Ω	HJ35 4270	HF854270	68 KΩ	HJ35 7680	HF85 7680
33 Ω	HJ35 4330	HF854330	82 KΩ	HJ35 7820	HF85 7820
39 Ω	HJ35 4390	HF854390	91 KΩ	HJ35 7910	HF85 7910
47 Ω	HJ35 4470	HF854470	100 KΩ	HJ35 8100	HF85 8100
56 Ω	HJ35 4560	HF854560	120 KΩ	HJ35 8120	HF85 8120
68 Ω	HJ35 4680	HF854680	150 KΩ	HJ35 8150	HF85 8150
82 Ω	HJ35 4820	HF854820	180 KΩ	HJ35 8180	HF85 8180
100 Ω	HJ35 5100	HF855100	220 KΩ	HJ35 8220	HF85 8220
110 Ω	HJ35 5110	HF855110	270 KΩ	HJ35 8270	HF85 8270
120 Ω	HJ35 5120	HF855120	330 KΩ	HJ35 8330	HF85 8330
150 Ω	HJ35 5150	HF855150	390 KΩ	HJ35 8390	HF85 8390
160 Ω	HJ35 5160	*	470 KΩ	HJ35 8470	HF85 8470
180 Ω	HJ35 5180	HF855180	560 KΩ	HJ35 8560	HF85 8560
220 Ω	HJ35 5220	HF855220	680 KΩ	HJ35 8680	HF85 8680
270 Ω	HJ35 5270	HF855270	820 KΩ	HJ35 8820	HF85 8820
330 Ω	HJ35 5330	HF855330	1.0 MΩ	HJ35 9100	HF85 9100
390 Ω	HJ35 5390	HF855390	1.2 MΩ	HJ35 9120	*
470 Ω	HJ35 5470	HF855470	1.5 MΩ	HJ35 9150	HF85 9150
510 Ω	*	HF855510	1.8 MΩ	HJ35 9180	HF85 9180
560 Ω	HJ35 5560	HF855560	2.2 MΩ	HJ35 9220	HF85 9220
680 Ω	HJ35 5680	HF855680	3.3 MΩ	HJ35 9330	HF85 9330
820 Ω	HJ35 5820	HF855820	3.9 MΩ	HJ35 9390	*
910 Ω	HJ35 5910	HF855910	4.7 MΩ	HJ35 9470	HF85 9470
1.0 KΩ	HJ35 6100	HF85 6100			
1.2 KΩ	HJ35 6120	HF85 6120			
1.5 KΩ	HJ35 6150	HF85 6150			
1.8 KΩ	HJ35 6180	HF85 6180			
2.0 KΩ	HJ35 6200	HF85 6200			
2.2 KΩ	HJ35 6220	HF85 6220			
2.4 KΩ	HJ35 6240	HF85 6240			
2.7 KΩ	HJ35 6270	HF85 6270			
3.0 KΩ	HJ35 6300	HF85 6300			
3.3 KΩ	HJ35 6330	HF85 6330			
3.6 KΩ	HJ35 6360	HF85 6360			
3.9 KΩ	HJ35 6390	HF85 6390			
4.7 KΩ	HJ35 6470	HF85 6470			
5.1 KΩ	HJ35 6510	HF85 6510			
5.6 KΩ	HJ35 6560	HF85 6560			
6.8 KΩ	HJ35 6680	HF85 6680			
8.2 KΩ	HJ35 6820	HF85 6820			
9.1 KΩ	HJ35 6910	HF85 6910			
10 KΩ	HJ35 7100	HF85 7100			

1/4W Type

HJ35 ○○○○

10mm

1/6W Type

HF85 ○○○○

5mm